

GENERAL DESCRIPTION

This document describes the specifications for the IDTF0480 400 MHz to 2700 MHz RF Digital Variable Gain Amplifier used in receiver, transmitter and other applications.

IDTF0480 RF DVGA provides 13 dB typical maximum gain (no attenuation) with 4 dB noise figure and 23 dB gain adjustment in 1 dB steps designed to operate with a single 5 V supply. Nominally, the device offers +41 dBm output IP3 using 100 mA of I_{CC} .

This device is packaged in a 5x5 32-pin thin QFN with 50 ohm single-ended RF input and RF output impedances for ease of integration into the signal-path lineup.

COMPETITIVE ADVANTAGE

In many applications, digital step attenuators followed by RF amplifiers are used in the Receive path. The IDTF0480 RF DVGA provides very high reliability by combining a silicon Glitch-Free™ DSA & a Zero-Distortion™ RF amplifier in a single, compact QFN package. Utilizing IDT's technology, the resultant RF VGA provides +41 dBm OIP3 performance across a very wide bandwidth of 400 MHz to 2700 MHz at approximately 100 mA of current. Furthermore the device is internally matched so there is no need to optimize external matching elements.

APPLICATIONS

- Multi-mode, Multi-carrier Receivers
- PCS1900 Base Stations
- DCS1800 Base Stations
- WiMAX and LTE Base Stations
- UMTS/WCDMA 3G Base Stations
- PHS/PAS Base Stations
- Point to Point Infrastructure
- Public Safety Infrastructure
- Broadband Repeaters
- GPS Receivers
- Distributed Antenna Systems
- Cable Infrastructure
- Digital Radio

FEATURES

- 400 MHz – 2700 MHz
- < 1 dB overshoot between gain transitions
- 13 dB typical max gain
- 23 dB gain range, 1 dB gain step resolution
- Excellent linearity +41 dBm OIP3
- Noise Figure 4 dB
- $I_{CC} = 100$ mA
- 1.3 mA standby current
- SPI interface
- 50 Ω input and output impedance
- Broadband, Internally Matched
- Gain increases vs. frequency to counteract system board losses
- 5x5 32-pin TQFN package

DEVICE BLOCK DIAGRAM



ORDERING INFORMATION

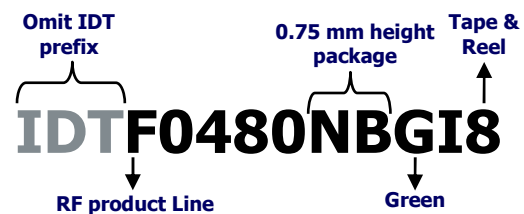

ABSOLUTE MAXIMUM RATINGS

| Parameter | Symbol | Min | Max | Units |
|--|-------------|-----------------|------------------|-------|
| VCC to GND | V_{CC} | -0.3 | +5.5 | V |
| SPI DATA, SPI CSb, SPI CLK, LogicCTL | V_{diD} | -0.3 | +3.6 | V |
| STBY, Band_Select | V_{Cntl} | -0.3 | $V_{CC} + 0.25$ | V |
| R_Bias1 | I_{R1} | | +1.5 | mA |
| R_Bias2 | I_{R1} | | +0.8 | mA |
| RFIN externally applied DC voltage | V_{RFin} | +1.4 | +3.6 | V |
| RFOUT externally applied DC voltage | V_{RFout} | $V_{CC} - 0.15$ | $V_{CC} + 0.15$ | V |
| RF Input Power (RFIN) applied for 24 hours maximum | P_{in} | | +22 | dBm |
| Continuous Power Dissipation | P_{diss} | | 1.5 | W |
| Junction Temperature | T_j | | 150 | °C |
| Storage Temperature Range | T_{st} | -65 | 150 | °C |
| Lead Temperature (soldering, 10s) | | | 260 | °C |
| ElectroStatic Discharge – HBM (JEDEC/ESDA JS-001-2012) | | | Class 2 (2000 V) | |
| ElectroStatic Discharge – CDM (JEDEC 22-C101F) | | | Class C2 (500 V) | |

Stresses above those listed above may cause permanent damage to the device. Functional operation of the device at these or any other conditions above those indicated in the operational section of this specification is not implied. Exposure to absolute maximum rating conditions for extended periods may affect device reliability.

PACKAGE THERMAL AND MOISTURE CHARACTERISTICS

| | |
|---|---------|
| θ_{JA} (Junction – Ambient) | 40 °C/W |
| θ_{JC} (Junction – Case) The Case is defined as the exposed paddle | 4 °C/W |
| Moisture Sensitivity Rating (Per J-STD-020) | MSL1 |



Matched Broadband RF VGA

400MHz to 2700MHz

IDTF0480 RECOMMENDED OPERATING CONDITIONS

| Parameter | Symbo l | Conditions | Min | Typ | Max | Unit s |
|-----------------------------|--------------------|-------------------|------------|------------|------------|-------------------|
| Supply Voltage(s) | V_{CC} | All VCC pins | 4.75 | | 5.25 | V |
| Operating Temperature Range | T_{CASE} | Case Temperature | -40 | | +105 | °C |
| RF Freq Range | F_{RF} | Operating Range | 400 | | 2700 | MHz |
| RF Source Impedance | Z_{RFI} | Single Ended | | 50 | | Ω |
| RF Load Impedance | Z_{RFO} | Single Ended | | 50 | | Ω |

IDTF0480 SPECIFICATION

See F0480 Typical Application Circuit. Specifications apply when operated as an RF DVGA, $V_{CC} = +5.00\text{ V}$, $T_C = +25\text{ }^\circ\text{C}$, Max gain setting, output power = 0 dBm, $Z_{RFI} = Z_{RFO} = 50\ \Omega$, unless otherwise noted.

| Parameter | Symbol | Conditions | Min | Typ | Max | Units |
|---------------------------------------|------------------|---|-------------------------------|-----|--------------------|---------------|
| Logic Input High | V_{IH} | JEDEC 3.3V logic | <i>2.0¹</i> | | | V |
| Logic Input Low | V_{IL} | JEDEC 3.3V logic | | | <i>0.8</i> | V |
| Logic Input High | V_{IH} | JEDEC 1.8V logic | <i>1.1</i> | | | V |
| Logic Input Low | V_{IL} | JEDEC 1.8V logic | | | <i>0.63</i> | V |
| Logic Current | I_{IH}, I_{IL} | STBY, Band_Select | <i>-10</i> | | <i>+10</i> | μA |
| | | SPI_ | <i>-4</i> | | <i>+4</i> | |
| | | Logic CTL | <i>-35</i> | | <i>+35</i> | |
| Supply Current ³ | I_{CC_LB} | Low Band Configuration | | 100 | | mA |
| | I_{CC_MB} | Mid Band Configuration | | 117 | <i>128</i> | |
| | I_{CC_HB} | High Band Configuration | | 109 | | |
| | I_{CC_STBY} | Standby Mode | | 1.3 | <i>1.7</i> | |
| Startup time | | 50% of STBY going low to Gain within $\pm 1\text{ dB}$ with no attenuation. | | 250 | | ns |
| Gain adjustment range | G_{ADJ} | | | 23 | | dB |
| Gain step | G_{STEP} | | | 1 | | dB |
| Max Attenuator Glitch | $ATTN_G$ | Step from 15 to 16 dB or 16 to 15 dB | | 0.5 | | dB |
| Gain Settling Time | G_{ST} | 50% of CSb to $\pm 0.1\text{ dB}$ of settled gain | | 500 | | ns |
| Serial Clock Speed | | | | | <i>10</i> | MHz |
| CSb to first serial clock rising edge | A | SPI 3 wire Bus. 50% of CSb falling edge to 50% of CLK rising edge. | <i>10</i> | | | ns |
| Serial Data Hold Time | B | SPI 3 wire Bus. 50% of CLK rising edge to 50% of Data falling edge. | <i>10</i> | | | ns |
| Final serial clock rising edge to CSb | C | SPI 3 wire Bus. 50% of CLK rising edge to 50% of CSB rising edge. | <i>10</i> | | | ns |

Note 1: Items in min/max columns in ***bold italics*** are Guaranteed by Test.

Note 2: Items in min/max columns that are not bold/italics are Guaranteed by Design Characterization.

Note 3: During standby mode, SPI is to be left ON and previous state shall be maintained when device is powered up.

IDTF0480 SPECIFICATION - LOWBAND PERFORMANCE

See F0480 Typical Application Circuit. Specifications apply when operated as an RF DVGA, $V_{CC} = +5.00\text{ V}$, $T_C = +25\text{ }^\circ\text{C}$, $F_{RF} = 900\text{ MHz}$, Band_Select = LB setting, Max gain setting, output power = 0 dBm, $Z_{RFI} = Z_{RFO} = 50\ \Omega$, the evaluation board and connector losses are de-embedded, unless otherwise noted.

| Parameter | Symbol | Conditions | Min | Typ | Max | Units |
|------------------------------------|-------------------|---|--------------|-----------|-------------|-------|
| RF input return loss | RL_{IN_LB} | | | 15 | | dB |
| RF output return loss | RL_{Out_LB} | | | 20 | | dB |
| Gain | G_{MAX_LB} | | 11.5 | 12.6 | 13.4 | dB |
| | G_{MIN_LB} | Maximum attenuation | -11.2 | -10.2 | -9.4 | |
| | G_{TEMP_LB} | Variation over Temperature | | ± 0.3 | | |
| | G_{VAR_LB} | Max gain variation over frequency ⁵ | | 0.1 | | |
| Step Error | G_{ACC_LB} | Between adjacent states | | ± 0.1 | | dB |
| Absolute Error | G_{ABSACC_LB} | Relative to maximum gain | | ± 0.2 | | dB |
| Phase deviation | $G_{PH_ADJ_LB}$ | Between adjacent states at maximum gain | | 1 | | Deg |
| Noise Figure | NF_{LB} | | | 3.9 | | dB |
| | NF_{LB_MG} | $T_{case} = +105\text{ }^\circ\text{C}$ | | 4.8 | | |
| | NF_{LB_RG} | 22 dB attenuation | | 25.9 | | |
| Output Third Order Intercept Point | $OIP3_{LB-1}$ | Pout = 0 dBm/Tone, 1 MHz tone separation | | 41.5 | | dBm |
| | $OIP3_{LB-2}$ | Pout = -10 dBm/Tone, 1 MHz tone separation | | 40.5 | | |
| | $OIP3_{LB-3}$ | Pout = 0 dBm/Tone, 1 MHz tone separation, Worst case in the operating temperature range | 39 | 41 | | |
| | $OIP3_{LB-6dB}$ | Pout = 0 dBm/Tone, 1 MHz tone separation with 6 dB attenuation | | 41 | | |
| Output 1 dB Power Compression | $OP1dB_{LB}$ | | 20.6 | 22.2 | | dBm |
| Output 0.2 dB Power Compression | $OP0.2dB_{LB}$ | | | 20 | | dBm |
| Output Saturated Power | $PSAT_{LB}$ | 3 dB compression | | 22.3 | | dBm |
| Reverse Isolation | REV_{ISO_LB} | | | 18 | | dB |

Note 5: Including frequency and ripple variations valid within each individual 3GPP band.

IDTF0480 SPECIFICATION - MIDBAND PERFORMANCE

See F0480 Typical Application Circuit. Specifications apply when operated as an RF DVGA, $V_{CC} = +5.00\text{ V}$, $T_C = +25\text{ }^\circ\text{C}$, $F_{RF} = 2000\text{ MHz}$, Band_Select = HB setting, Max gain setting, output power = 0 dBm, $Z_{RFI} = Z_{RFO} = 50\ \Omega$, the evaluation board and connector losses are de-embedded, unless otherwise noted.

| Parameter | Symbol | Conditions | Min | Typ | Max | Units |
|------------------------------------|-------------------|---|-------------|-----------|-------------|-------|
| RF input return loss | RL_{IN_MB} | | | 13 | | dB |
| RF output return loss | RL_{Out_MB} | | | 17 | | dB |
| Gain | G_{MAX_MB} | | 11.9 | 13.1 | 14.2 | dB |
| | G_{MIN_MB} | Maximum attenuation | -11 | -9.9 | -8.7 | |
| | G_{TEMP_MB} | Variation over Temperature | | ± 0.3 | | |
| | G_{VAR_MB} | Max gain variation over frequency ⁵ | | 0.1 | | |
| Step Error | G_{ACC_MB} | Between adjacent states | | ± 0.1 | | dB |
| Absolute Error | G_{ABSACC_MB} | Relative to maximum gain | -0.6 | ± 0.2 | +0.6 | dB |
| Phase deviation | $G_{PH_ADJ_MB}$ | Between adjacent states at maximum gain | | 2 | | Deg |
| Noise Figure | NF_{MB} | | | 4.5 | | dB |
| | NF_{MB_MG} | $T_{case} = +105\text{ }^\circ\text{C}$ | | 5.5 | 5.9 | |
| | NF_{MB_RG} | 22 dB attenuation | | 26.7 | 28.2 | |
| Output Third Order Intercept Point | $OIP3_{MB-1}$ | Pout = 0 dBm/Tone, 1 MHz tone separation | 38 | 41.5 | | dBm |
| | $OIP3_{MB-2}$ | Pout = -10 dBm/Tone, 1 MHz tone separation | | 42.5 | | |
| | $OIP3_{MB-3}$ | Pout = 0 dBm/Tone, 1 MHz tone separation, Worst case in the operating temperature range | 39 | 41.1 | | |
| | $OIP3_{MB-6dB}$ | Pout = 0 dBm/Tone, 1 MHz tone separation with 6 dB attenuation | | 41.5 | | |
| Output 1 dB Power Compression | $OP1dB_{MB}$ | | | 22.2 | | dBm |
| Output 0.2 dB Power Compression | $OP0.2dB_{MB}$ | | | 18.5 | | dBm |
| Output Saturated Power | $PSAT_{MB}$ | 3 dB compression | | 22.7 | | dBm |
| Reverse Isolation | REV_{ISO_MB} | | | 18 | | dB |

IDTF0480 SPECIFICATION - HIGHBAND PERFORMANCE

See F0480 Typical Application Circuit. Specifications apply when operated as an RF DVGA, $V_{CC} = +5.00\text{ V}$, $T_C = +25\text{ }^\circ\text{C}$, $F_{RF} = 2700\text{ MHz}$, Band_Select = HB setting, Max gain setting, output power = 0 dBm, $Z_{RFI} = Z_{RFO} = 50\ \Omega$, the evaluation board and connector losses are de-embedded, unless otherwise noted.

| Parameter | Symbol | Conditions | Min | Typ | Max | Units |
|------------------------------------|-------------------|---|--------------|-----------|-------------|-------|
| RF input return loss | RL_{IN_HB} | | | 12 | | dB |
| RF output return loss | RL_{Out_HB} | | | 15 | | dB |
| Gain | G_{MAX_HB} | | 12.2 | 13.5 | 14.4 | dB |
| | G_{MIN_HB} | Maximum attenuation | -10.7 | -9.5 | -8.4 | |
| | G_{TEMP_HB} | Variation over Temperature | | ± 0.3 | | |
| | G_{VAR_HB} | Max gain variation over frequency ⁵ | | 0.1 | | |
| Step Error | G_{ACC_HB} | Between adjacent states | | ± 0.1 | | dB |
| Absolute Error | G_{ABSACC_HB} | Relative to maximum gain | | ± 0.2 | | dB |
| Phase deviation | $G_{PH_ADJ_HB}$ | Between adjacent states at maximum gain | | 3 | | Deg |
| Noise Figure | NF_{HB} | | | 5 | | dB |
| | NF_{HB_MG} | $T_{case} = +105\text{ }^\circ\text{C}$ | | 5.8 | | |
| | NF_{HB_RG} | 22 dB attenuation | | 26.8 | | |
| Output Third Order Intercept Point | $OIP3_{HB-1}$ | Pout = 0 dBm/Tone, 1 MHz tone separation | | 39.2 | | dBm |
| | $OIP3_{HB-2}$ | Pout = -10 dBm/Tone, 1 MHz tone separation | | 38.5 | | |
| | $OIP3_{HB-3}$ | Pout = 0 dBm/Tone, 1 MHz tone separation, Worst case in the operating temperature range | 35.5 | 36.7 | | |
| | $OIP3_{HB-6dB}$ | Pout = 0 dBm/Tone, 1 MHz tone separation with 6 dB attenuation | | 39 | | |
| Output 1 dB Power Compression | $OP1dB_{HB}$ | | | 21.8 | | dBm |
| Output 0.2 dB Power Compression | $OP0.2dB_{HB}$ | | | 21.6 | | dBm |
| Output Saturated Power | $PSAT_{HB}$ | 3 dB compression | | 22.2 | | dBm |
| Reverse Isolation | REV_{ISO_HB} | | | 18 | | dB |

SERIAL CONTROL MODE

Data is clocked in LSB first via serial mode. Note the timing diagram below.

Note – The IDTF0480 includes a CLK inhibit feature designed to minimize sensitivity to CLK bus noise when the device is not being programmed. When CSb is high ($> V_{IH}$), the CLK input is disabled and serial data (DATA) is not clocked into the shift register. It is recommended that CSb be pulled high ($> V_{IH}$) when the device is not being programmed.

SERIAL REGISTER TIMING DIAGRAM: (Note the Timing Spec Intervals in **Blue**)

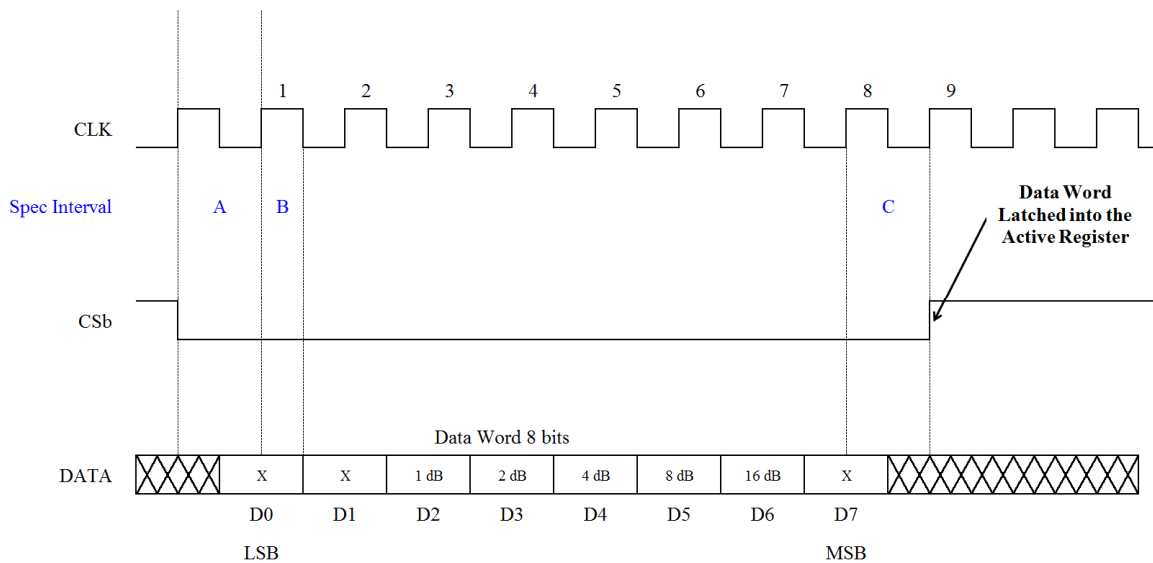

SERIAL MODE DEFAULT CONDITION:

When the device is first powered up it will default to the **Maximum Attenuation** setting as described below:

Default Register Settings

| | | | | | | | |
|-----|----|----|----|----|----|----|-----|
| x | x | 1 | 1 | 1 | 1 | 1 | x |
| D0 | D1 | D2 | D3 | D4 | D5 | D6 | D7 |
| LSB | | | | | | | MSB |

Figure 1 - SPI timing diagram & default register settings

F0480 DVGA ATTENUATION WORD TRUTH TABLE (LSB = first in)

The SPI interface should be built up by an 8-bit word (defined as MOSI) where 5 bits are used for attenuation setting per the example shown below. **BOLD** indicates bits used for programming the attenuator; data bits 2 through 6.

| D7 (MSB) | D6 | D5 | D4 | D3 | D2 | D1 | D0 (LSB) | ATTENUATION SETTING |
|-----------------|-----------|-----------|-----------|-----------|-----------|-----------|-----------------|----------------------------|
| x | Low | Low | Low | Low | Low | x | x | insertion loss |
| x | Low | Low | Low | Low | High | x | x | 1 dB |
| x | Low | Low | Low | High | Low | x | x | 2 dB |
| x | Low | Low | High | Low | Low | x | x | 4 dB |
| x | Low | High | Low | Low | Low | x | x | 8 dB |
| x | High | Low | Low | Low | Low | x | x | 16 dB |
| x | High | Low | High | High | Low | x | x | 22 dB |
| x | High | Low | High | High | High | x | x | 23 dB (max) |
| x | High | High | Low | Low | Low | x | x | 23 dB (max) |
| x | High | High | Low | Low | High | x | x | 23 dB (max) |
| x | High | High | Low | High | Low | x | x | 23 dB (max) |
| x | High | High | Low | High | High | x | x | 23 dB (max) |
| x | High | High | High | Low | Low | x | x | 23 dB (max) |
| x | High | High | High | Low | High | x | x | 23 dB (max) |
| x | High | High | High | High | Low | x | x | 23 dB (max) |
| x | High | High | High | High | High | x | x | 23 dB (max) |

STANDBY TRUTH TABLE*

| PARAMETER | LEVEL | FUNCTION |
|------------------|-------------------------|-----------------|
| STBY | 0 Volts or Open Circuit | Power On |
| | +5 Volts | Power Off |

*** Startup/Power on requirements:**

SPI shall be left on during Standby mode. When the circuit is initially powered up (+5V applied on pin 12/13), the default VGA setting should be minimum gain (max attenuation setting). If the attenuator is programmed in Standby mode, the programmed setting will be active when the device is taken out of Standby mode.

SPI LOGIC LEVEL CONTROL - PIN 11

| PARAMETER | LEVEL | FUNCTION |
|------------------|---------------------------|-----------------|
| LogicCTL | 3.3 Volts or open Circuit | 3.3V logic |
| | 0 Volts | 1.8V logic |

SUGGESTED C5, R7, AND R8 VALUES FOR OPTIMUM PERFORMANCE (UNLESS OTHERWISE NOTED IN TOCs)

| Band | Freq Range (MHz) | Band Select Pin 15 | R7 (kΩ) | R8 (kΩ) | C5 (pF) | I_{cc} (mA) |
|----------------------------|-------------------------|---------------------------|----------------------------------|----------------------------------|----------------|----------------------------|
| Low-Band | 700 - 1100 | LB (Open) | 2.2 | 9.1 | 9 | 100 |
| Mid-Band | 1100 - 2200 | HB (GND) | 2.4 | 27 | 9 | 117 |
| High-Band | 2200 - 2700 | HB (GND) | 2.67 | 75 | 6 | 109 |
| Broad-Band (p. 16 TOCs) | 400 - 2700 | HB (GND) | 2.2 | 20 | 9 | 124 |

TYPICAL OPERATING CONDITIONS

Unless otherwise noted for the TOC graphs, the following conditions apply

- **V_{cc} = 5.0 V**
- **P_{out} = 0 dBm / Tone**
- **1 MHz Tone Spacing**
- **T_{CASE} = 35 °C, T_{AMB} = 25 °C**
- **ATTN setting = 0 dB (Max Gain)**
- **EVkit losses (traces and connectors) fully de-embedded**

TYPICAL OPERATING CONDITIONS [IP3, COMPRESSION] (-1-)

Output IP3 [0 dBm/Tone, 1M Tone Spacing, 0dB ATTN]

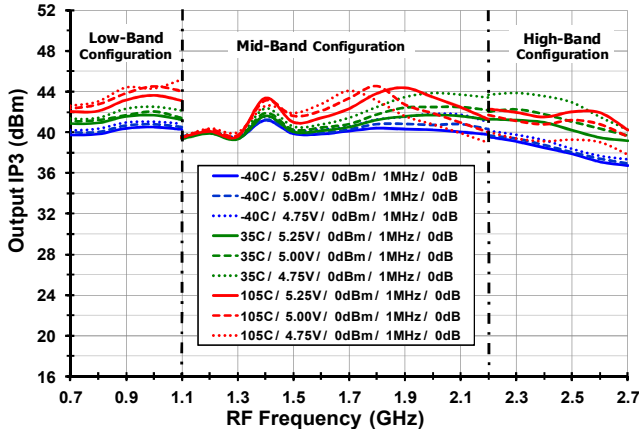

Output IP3 [0 dBm/Tone, 10M Tone Spacing, 0 dB ATTN]

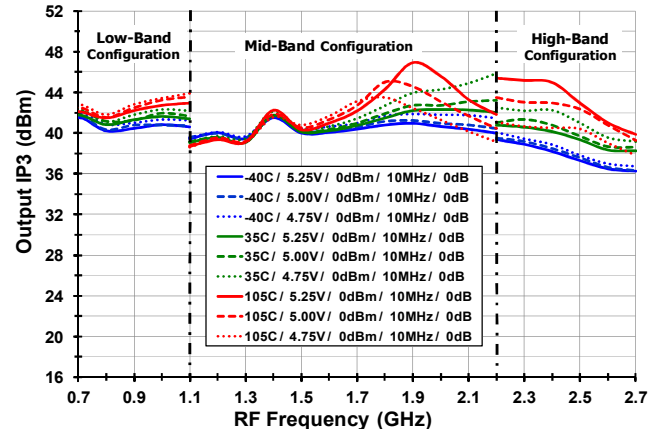

Output IP3 [0 dBm/Tone, 1M Tone Spacing, 11dB ATTN]

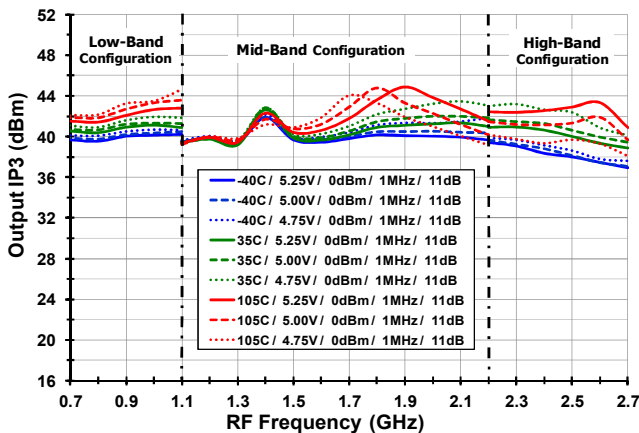

Output IP3 [-7 dBm/Tone, 1M Tone Spacing, 0dB ATTN]

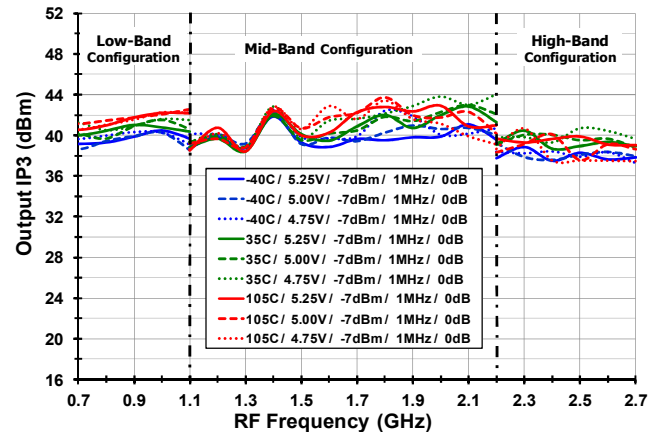

Gain Compression [900 MHz]

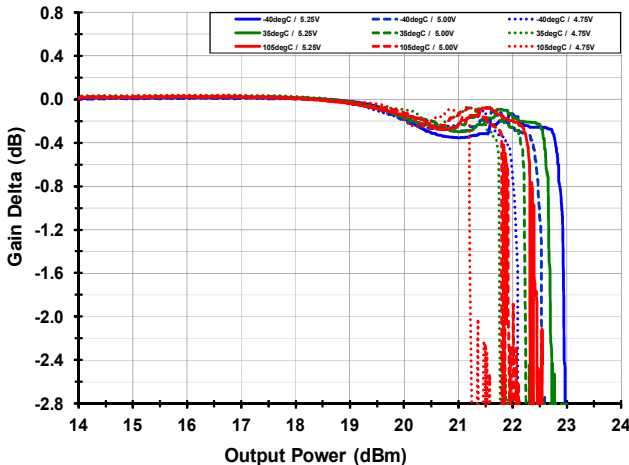

Phase Compression [900 MHz]

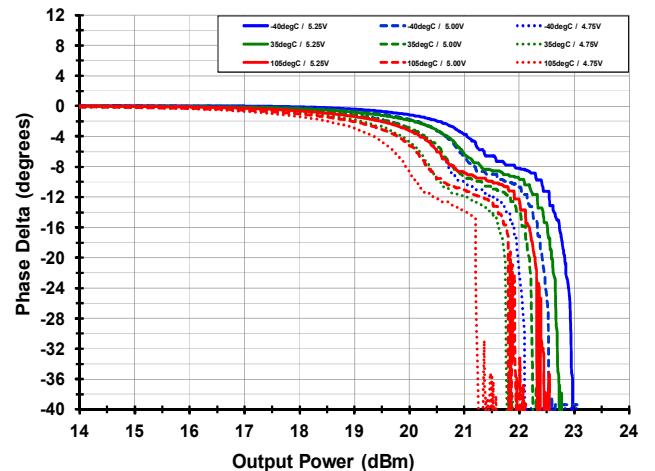



TOCs [COMPRESSION, NF] (-2-)

Gain Compression [2000 MHz]

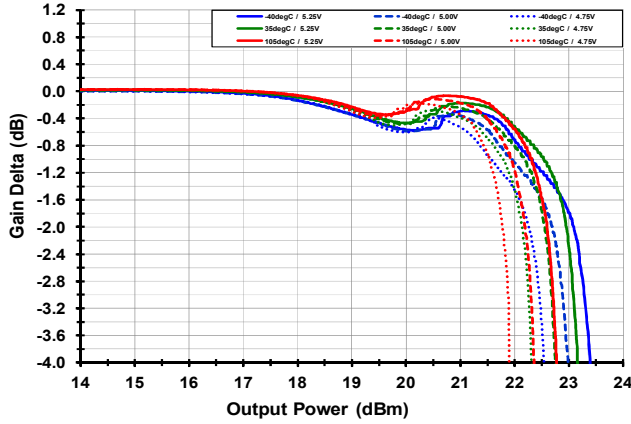

Phase Compression [2000 MHz]



Gain Compression [2700 MHz]

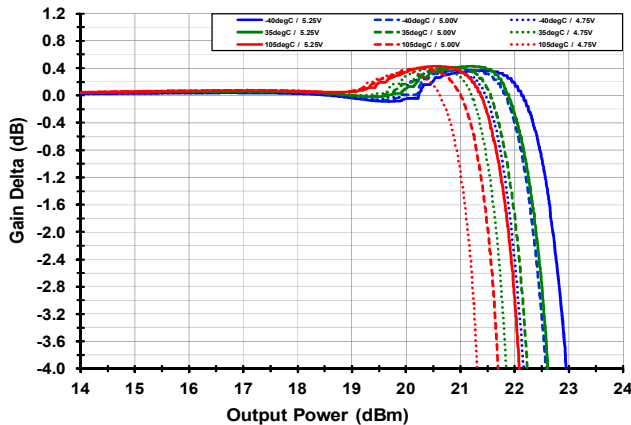

Phase Compression [2700 MHz]



Noise Figure vs. Temperature



Worst Case NF vs. Frequency [105C, 5.25V]

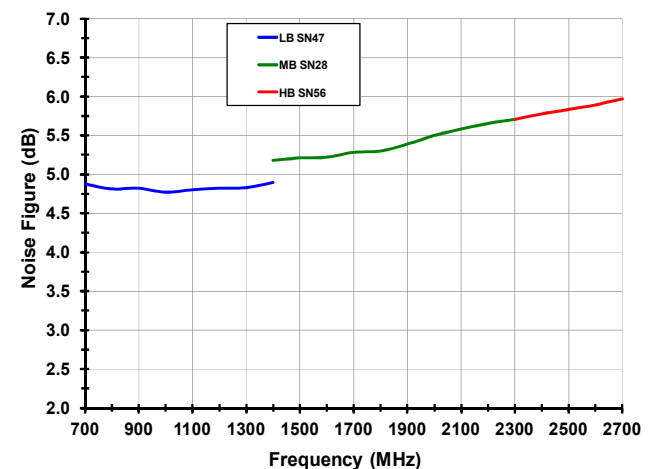

TOCs [GAIN, S-PARAMS WITHOUT C5, ATTN ERROR] (-3-)

Gain vs. Temperature and Voltage

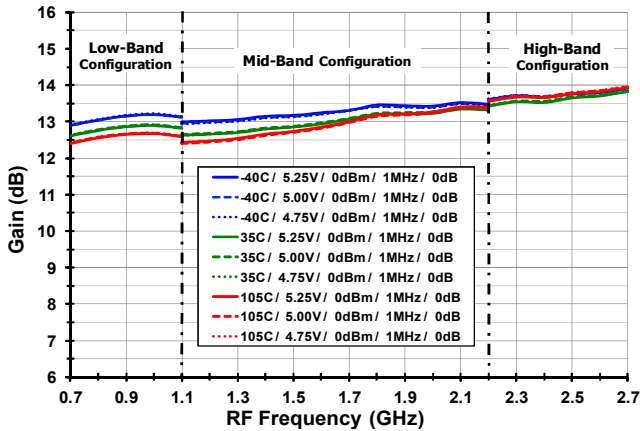

S₂₁ (device only) [T_{AMB} = 25C, V_{CC} = 5.00 Volts]

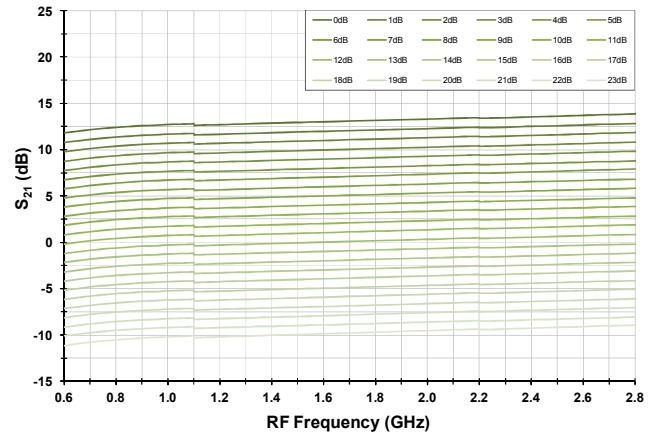

S₁₁ (device only) [T_{AMB} = 25C, V_{CC} = 5.00 Volts]

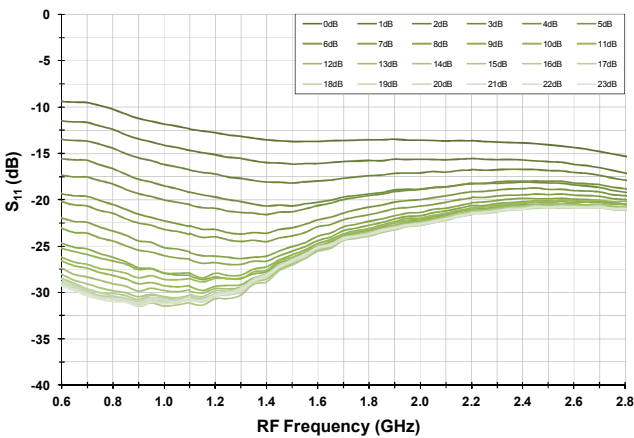

S₂₂ (device only) [T_{AMB} = 25C, V_{CC} = 5.00 Volts]

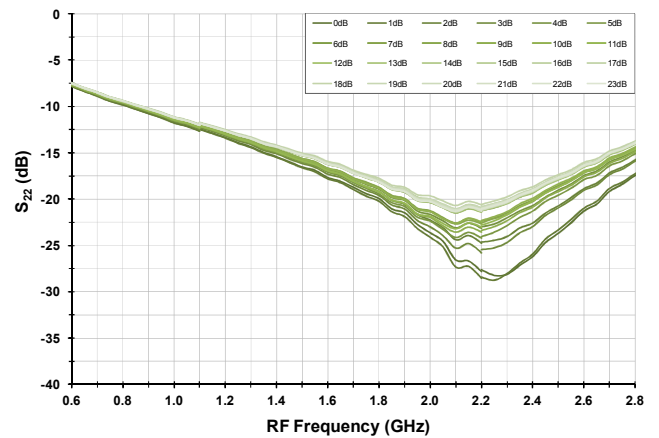

S₁₂ (device only) [T_{AMB} = 25C, V_{CC} = 5.00 Volts]

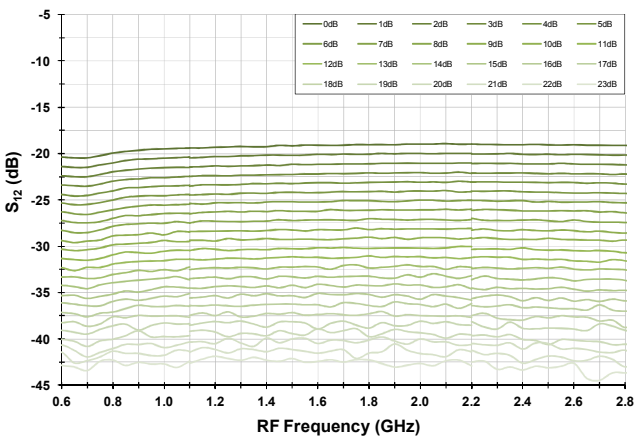

INL (device only) [T_{AMB} = 25C, V_{CC} = 5.00V]

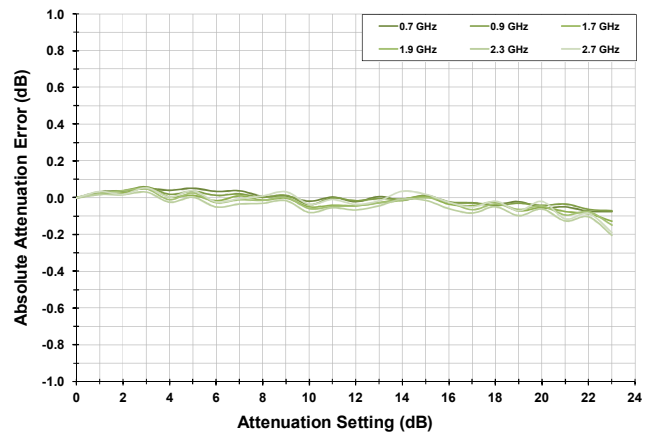

TOCs [PHASE ERROR, S-PARAMS WITH C5, STABILITY] (-4-)

Phase Delta (device only) [T_{AMB} = 25C, V_{CC} = 5.00V]



S21 (device+C5 cap) [T_{AMB} = 25C, V_{CC} = 5.00 Volts]

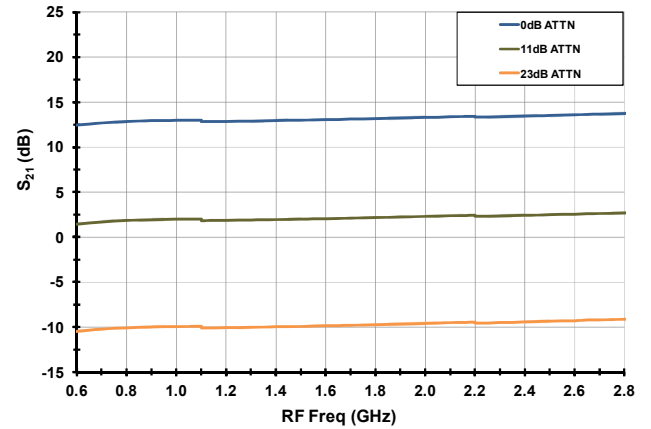

S11 (device+C5 cap) [T_{AMB} = 25C, V_{CC} = 5.00 Volts]

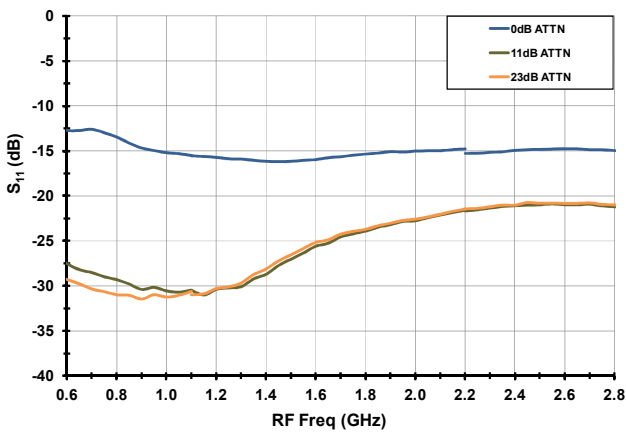

S22 (device+C5 cap) [T_{AMB} = 25C, V_{CC} = 5.00 Volts]

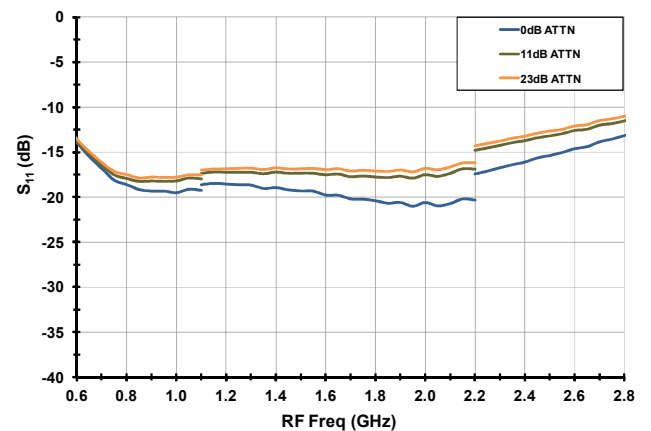

S12 (device+C5 cap) [T_{AMB} = 25C, V_{CC} = 5.00 Volts]

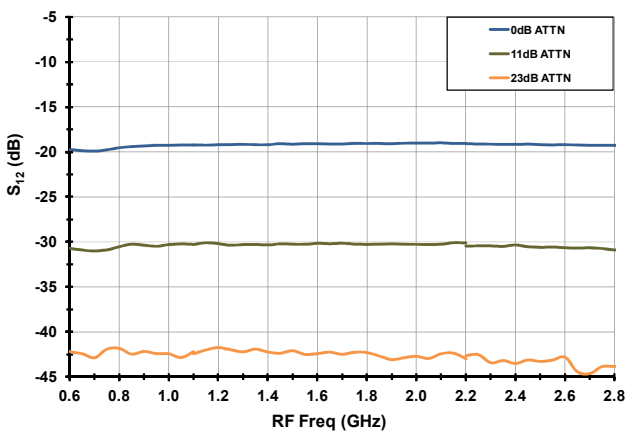

Stability v. ATTN [see discussion on p.18]

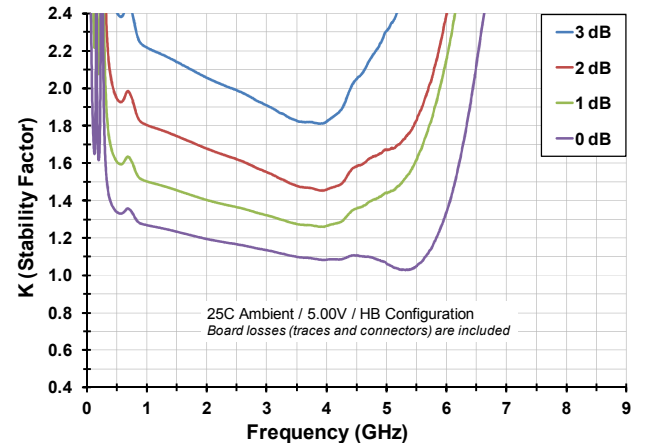

TOCs [MORE IP3, EVKIT LOSSES] (-5-)

OIP3 vs. Temperature [2.5 GHz, 5.00V]



OIP3 vs. Tone Spacing [2.5 GHz, 5.00V]

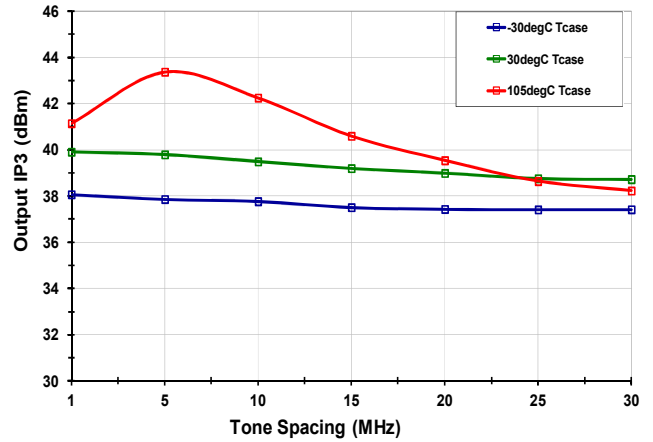

OIP3 vs. Output Power [2.5 GHz, T_{AMB} = 85C]



EVKit losses [connector and traces] (Rev 02 RO)

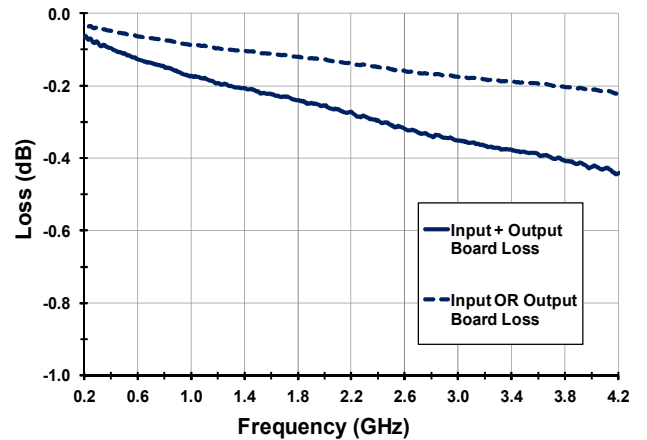

OIP3 v. ATTN [2.5 GHz, T_{AMB} = 85C, P_{out} = -5 dBm]



OIP3 vs. Output Power [2.7 GHz, Δf = 1 MHz]

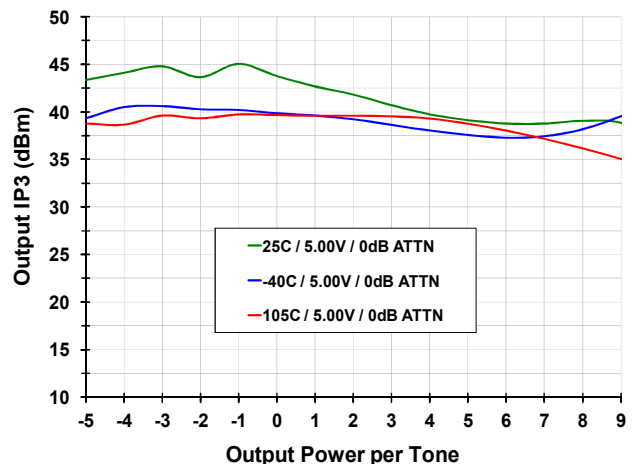

Matched Broadband RF VGA

400MHz to 2700MHz

TOCs [BROADBAND CONFIG] (-6-)

OIP3 vs. T_{CASE} & Tone Offset [0 dB ATTN]



OIP3 vs. T_{CASE} & Tone Offset [10 dB ATTN]



OIP3 vs. T_{CASE} & Tone Offset [13 dB ATTN]

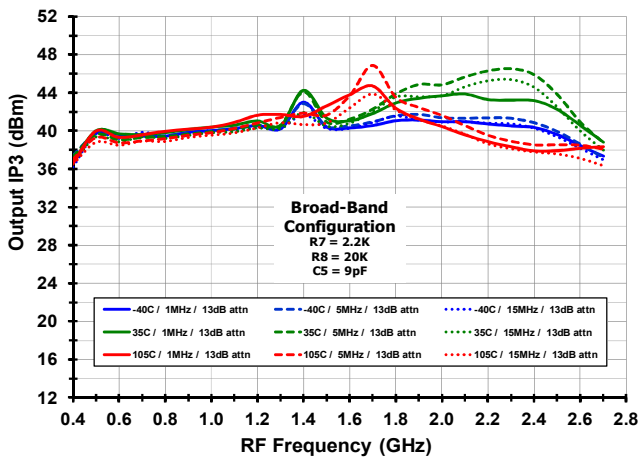

Gain vs. T_{CASE} & ATTN setting

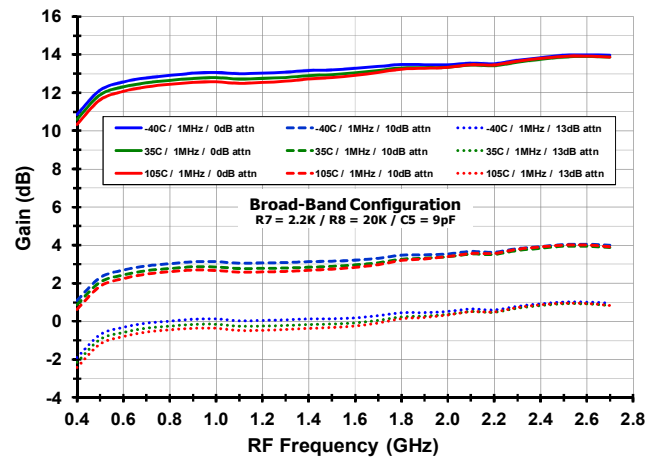

Wideband OIP2 [$T_{AMB} = 25C$, $P_{out} = -10$ dBm/Tone]

| MHz | MHz | MHz | MHz | dBm | dBm | dBm | dBm |
|-------|-------|-------------------|-------------------|-------------------|-------------------|-------------------|-------------------|
| F_1 | F_2 | IMD ₂₋ | IMD ₂₊ | IMD ₂₋ | OIP ₂₋ | IMD ₂₊ | OIP ₂₊ |
| 700 | 1950 | 1250 | 2650 | -71.1 | 51.1 | -69.3 | 49.3 |
| 700 | 1720 | 1020 | 2420 | -70.4 | 50.4 | -69.6 | 49.6 |
| 700 | 2650 | 1950 | | -71.8 | 51.8 | | |
| 824 | 900 | | 1724 | | | -71.5 | 51.5 |
| 900 | 1720 | 820 | 2620 | -70.4 | 50.4 | -70.3 | 50.3 |
| 1755 | 2600 | 845 | | -69.4 | 49.4 | | |
| 1900 | 2600 | 700 | | -69.3 | 49.3 | | |

Wideband OIP2 [$T_{AMB} = 25C$, $P_{out} = 0$ dBm/Tone]

| MHz | MHz | MHz | MHz | dBm | dBm | dBm | dBm |
|-------|-------|-------------------|-------------------|-------------------|-------------------|-------------------|-------------------|
| F_1 | F_2 | IMD ₂₋ | IMD ₂₊ | IMD ₂₋ | OIP ₂₋ | IMD ₂₊ | OIP ₂₊ |
| 700 | 1950 | 1250 | 2650 | -50.9 | 50.9 | -49.2 | 49.2 |
| 700 | 1720 | 1020 | 2420 | -50.2 | 50.2 | -49.5 | 49.5 |
| 700 | 2650 | 1950 | | -51.4 | 51.4 | | |
| 824 | 900 | | 1724 | | | -51.2 | 51.2 |
| 900 | 1720 | 820 | 2620 | -50.0 | 50.0 | -50.2 | 50.2 |
| 1755 | 2600 | 845 | | -49.0 | 49.0 | | |
| 1900 | 2600 | 700 | | -48.9 | 48.9 | | |

TOCs [HISTOGRAMS] (-7-)

Gain [N = 2107]



OIP3 [Freq = 2.0 GHz, N = 2107]

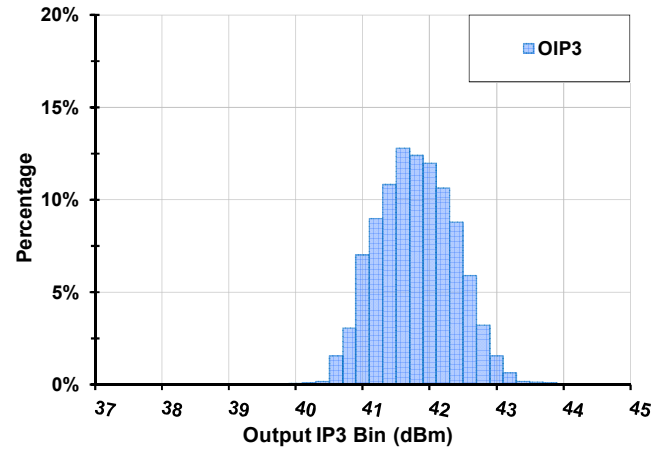

Total Current [MidBand Config, N = 2107]

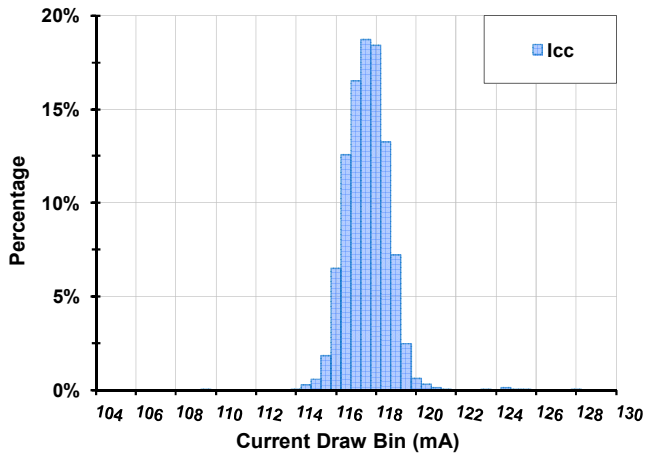

ATTN Accuracy [Freq = 2.0 GHz, N = 2107]

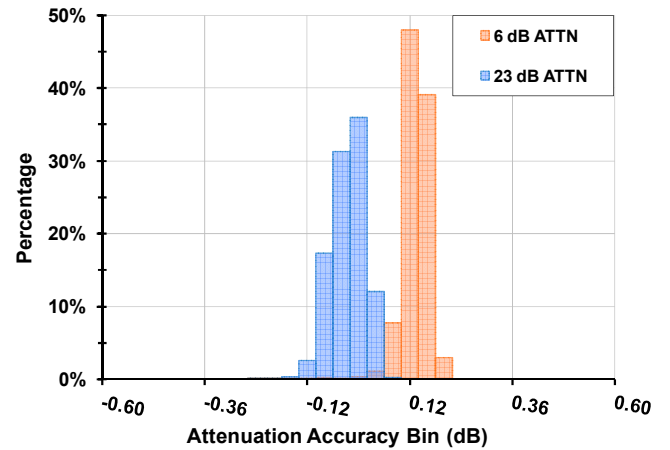

STABILITY CONSIDERATIONS

The IDTF0480 EVkit is unconditionally stable as shown on page 14, bottom right graph.

One can ensure that the device itself is unconditionally stable (Rollett Stability factor $[K] > 1$) regardless of trace and connector losses present in the actual application by adding a shunt 500 ohm resistor at the output. For the HB configuration, it is also advised to change R8 to 400K and C5 to 4.7 pF.

This 500 ohm shunt load will reduce the gain by about 0.4 dB but leave the rest of the performance parameters such as IP3, S22, etc. virtually unchanged.

The 500 ohm shunt load will ensure that the device is unconditionally stable WITHOUT the presence of the input and output traces and connectors associated with the EVkit. In all cases we do recommend that the output capacitor, C5, be placed as close to the output of the package as possible.

Shunt 500 ohm output resistor with 100 pF DC block to ground.
Alternately can be hooked directly to V_{CC} in parallel with RF choke inductor

Change C5 to 4.7 pF (HB config only)

Change R8 to 400K (HB config only)

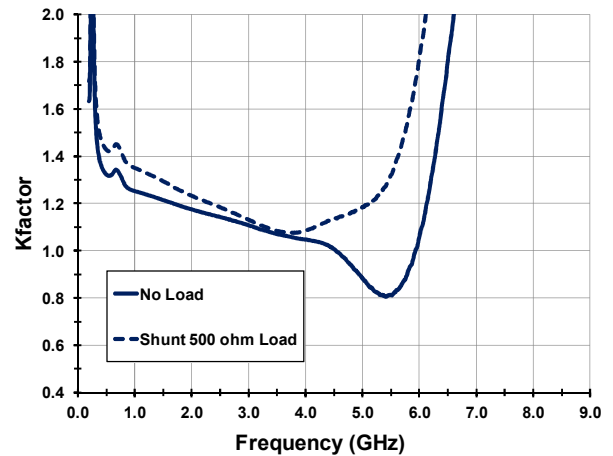
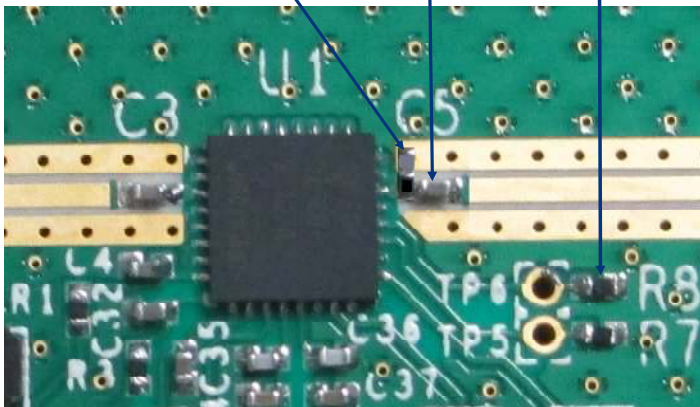

Gain Comparison (25C Ambient) and Output IP3 Comparison (2.7 GHz Frequency)

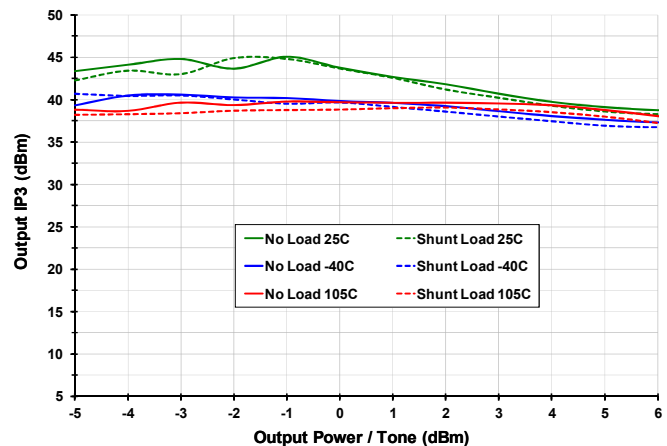

Matched Broadband RF VGA

400MHz to 2700MHz

PACKAGE DRAWING

(5MM X 5MM 32-PIN TQFN), USE EXPOSED PAD (EPAD) OPTION P1



| SYMBOL | DIMENSION | | |
|--------|-----------|------|------|
| | MIN | NOM | MAX |
| L | 0.30 | 0.40 | 0.50 |
| D | 5.00 BSC | | |
| E | 5.00 BSC | | |
| e | 0.50 BSC | | |
| A | 0.70 | 0.75 | 0.80 |
| A1 | 0.00 | 0.02 | 0.05 |
| b | .20 | .25 | .30 |
| aaa | 0.10 | | |
| bbb | 0.10 | | |
| ccc | 0.10 | | |
| ddd | 0.05 | | |
| eee | 0.08 | | |
| fff | 0.10 | | |

EPAD OPTION

| SYMBOL | P1 | | | P2 | | |
|--------|------|------|------|------|------|------|
| | MIN | NOM | MAX | MIN | NOM | MAX |
| E2 | 3.00 | 3.10 | 3.20 | 3.10 | 3.30 | 3.40 |
| D2 | 3.00 | 3.10 | 3.20 | 3.10 | 3.30 | 3.40 |

NOTES:

1. ALL DIMENSIONING AND TOLERANCING CONFORM TO ANSI Y14.5M-1982
2. ALL DIMENSIONS ARE IN MILLIMETERS.

PIN DIAGRAM

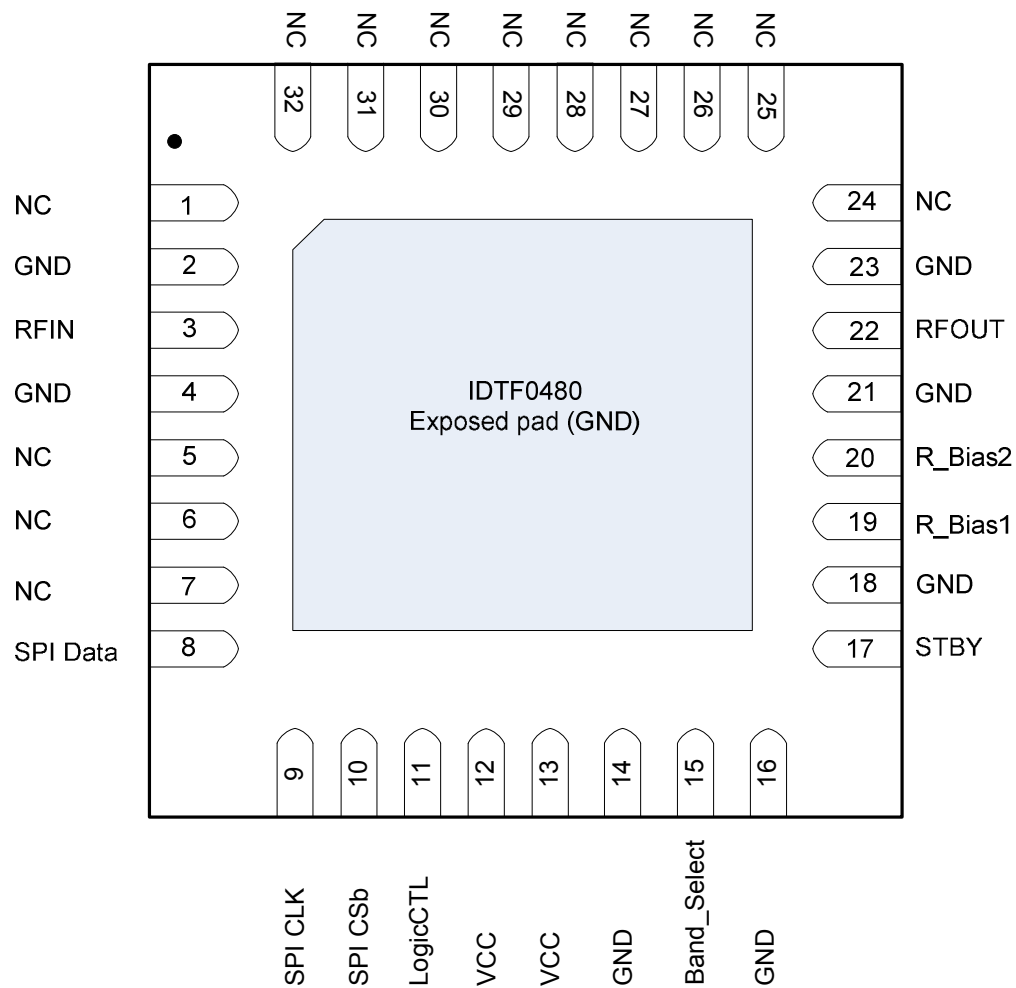

PIN DESCRIPTION

| Pin | Name | Function |
|--|-----------------------|---|
| 1, 5, 6, 7, 24, 25, 26, 27, 28, 29, 30, 31, 32 | N.C. | No Connection. Not internally connected. OK to connect to VCC. OK to connect to GND. |
| 2, 4, 14, 16, 18, 21, 23 | GND | Ground these pins. |
| 3 | RFIN | RF input internally matched to 50 Ω . Must use external DC block as close to the pin as possible. |
| 8 | SPI Data ¹ | Data input: 3.3V or 1.8V CMOS compatible. Set LogicCTL pin 11 for desired logic voltage. |
| 9 | SPI CLK ¹ | Clock input: 3.3V or 1.8V CMOS compatible. Set LogicCTL pin 11 for desired logic voltage. |
| 10 | SPI CSB ¹ | Chip Select input: 3.3V or 1.8V CMOS compatible. Set LogicCTL pin 11 for desired logic voltage. Active LOW shifts data. |
| 11 | LogicCTL | LogicCTL $\geq V_{IH}$ or Open Circuit sets 3.3V logic for SPI pins 8, 9, and 10. LogicCTL $\leq V_{IL}$ sets 1.8V logic for SPI pins 8, 9, and 10. A $\sim 100\text{k}\Omega$ pull-up resistor connects between the input and Vcc/2. For 1.8V logic, connect 0 Ω resistor to GND. |
| 12 | VCC | 5 V Power Supply. Tie to VCC and connect 2 bypass capacitors with values 1000 pf (closest to pin) and 0.1 μF . See Typical Application Circuit for details. |
| 13 | VCC | 5 V Power Supply. Tie to VCC and connect 2 bypass capacitors with values 1000 pf (closest to pin) and 0.1 μF . See Typical Application Circuit for details. |
| 15 | Band_Select | Leave pin open circuited for lowband select and connect 0 Ω resistor to GND for highband select. A $\sim 1.5\text{M}\Omega$ pull-up resistor connects between the input and VCC. 3.3V and 1.8V CMOS logic compatible. |
| 17 | STBY | Standby (Low/Open = device power ON, High = device power OFF with SPI still powered ON). A $\sim 1\text{M}\Omega$ pull-down resistor connects between the input and GND. 3.3V and 1.8V CMOS logic compatible |
| 19 | R_Bias1 | Connect external resistor to GND to optimize amplifier bias. Used in conjunction with pin 20. |
| 20 | R_Bias2 | Connect external resistor to GND to optimize amplifier bias. Used in conjunction with pin 19. |
| 22 | RFOUT | RF output. Must use external DC block as close to the pin as possible. |
| 33 | — EP | Exposed Pad. Internally connected to GND. Solder this exposed pad to a PCB pad that uses multiple ground vias to provide heat transfer out of the device into the PCB ground planes. These multiple via grounds are also required to achieve the noted RF performance. |

1. The SPI interface should be built up by an 8-bit word where 5 bits are used for attenuation setting (see F0480 DVGA Attenuation word truth table above).

EVKIT PICTURE

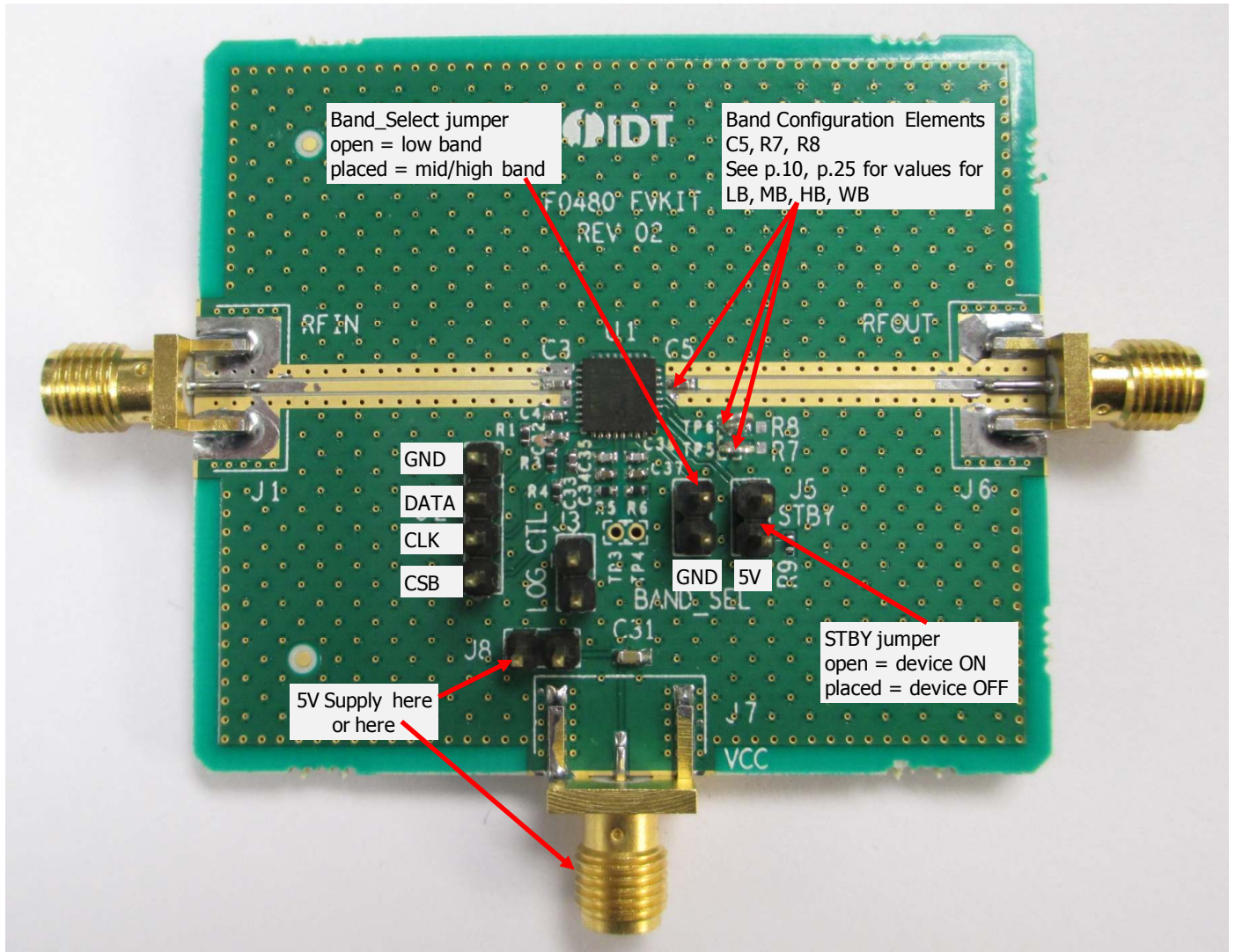

EVKIT / APPLICATIONS CIRCUIT

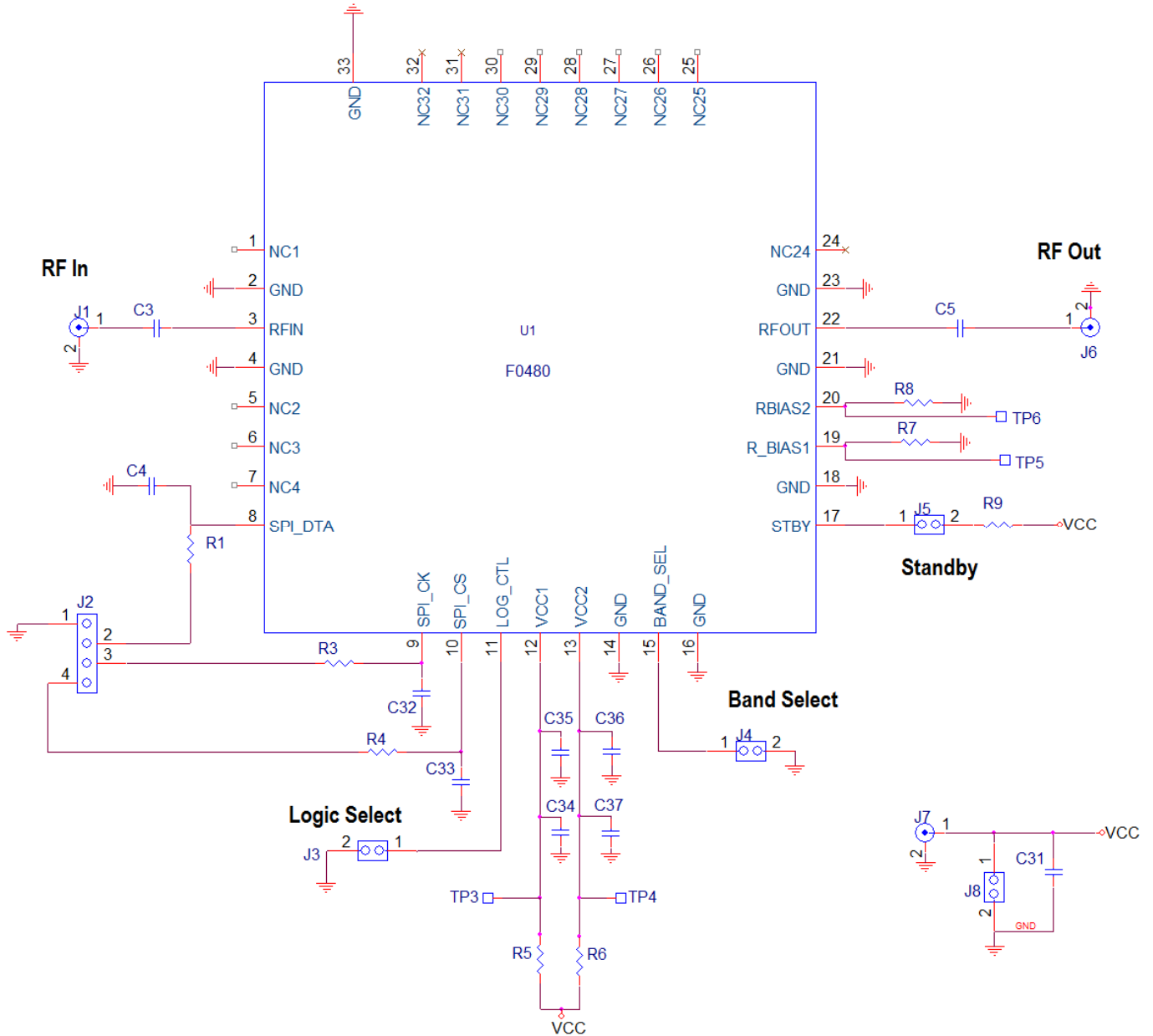



Matched Broadband RF VGA

400MHz to 2700MHz

EVKIT / APPLICATIONS CIRCUIT (CONT)

EVKIT BOM

| Item # | Part Reference | QTY | DESCRIPTION | Mfr. Part # | Mfr. |
|--------|----------------|-----|---|--------------------|-----------------|
| 1 | C5 | 1 | LB Mode - CAP CER 9PF 50V COG (0402) | GRM1555C1H9R0DZ01D | Murata |
| | | 1 | MB Mode - CAP CER 9PF 50V COG (0402) | GRM1555C1H9R0DZ01D | |
| | | 1 | HB Mode - CAP CER 6PF 50V COG (0402) | GRM1555C1H6R0DZ01D | |
| | | 1 | BB Mode - CAP CER 9PF 50V COG (0402) | GRM1555C1H9R0DZ01D | |
| 2 | C4, C32, C33 | 3 | CAP CER 2PF 50V COG (0402) | GRM1555C1H2R0BA01D | Murata |
| 3 | C3 | 1 | CAP CER 47PF 50V COG (0402) | GRM1555C1H470JZ01D | Murata |
| 4 | C35, C36 | 2 | CAP CER 1000PF 50V COG (0402) | GRM1555C1H102JA01D | Murata |
| 5 | C34, C37 | 2 | CAP CER 0.1UF 16V 10% X7R (0402) | GRM155R71C104KA88D | Murata |
| 6 | C31 | 1 | CAP CER 10UF 6.3V X5R 0603 | GRM188R60J106ME47D | Murata |
| 7 | R6, R9 | 2 | RES 0.0 OHM 1/10W (0402) SMD | ERJ-2GE0R00X | Panasonic |
| 8 | R5 | 1 | RES 20 OHM 1/10W 1% (0402) SMD | ERJ-2RKF20R0X | Panasonic |
| 9 | R1, R3, R4 | 3 | RES 4700 OHM 1/10W 5% (0402) SMD | ERJ-2GEJ472X | Panasonic |
| 10 | R7 | 1 | LB Mode - RES 2.2 KOHM 1/10W (0402) SMD | ERJ-2RKF2201X | Panasonic |
| | | 1 | MB Mode - RES 2.4 KOHM 1/10W (0402) SMD | ERJ-2RKF2401X | |
| | | 1 | HB Mode - RES 2.67 KOHM 1/10W (0402) SMD | ERJ-2RKF2671X | |
| | | 1 | BB Mode - RES 2.2 KOHM 1/10W (0402) SMD | ERJ-2RKF2201X | |
| 11 | R8 | 1 | LB Mode - RES 9.1 KOHM 1/10W (0402) SMD | ERJ-2RKF9101X | Panasonic |
| | | 1 | MB Mode - RES 27 KOHM 1/10W (0402) SMD | ERJ-2RKF2702X | |
| | | 1 | HB Mode - RES 75 KOHM 1/10W (0402) SMD | ERJ-2RKF7502X | |
| | | 1 | BB Mode - RES 20 KOHM 1/10W (0402) SMD | ERJ-2RKF2002X | |
| 12 | J1, J6, J7 | 3 | SMA_END_LAUNCH (small) | 142-0711-821 | Emerson Johnson |
| 13 | J3, J4, J5, J8 | 4 | CONN HEADER VERT SGL 2POS GOLD | 961102-6404-AR | 3M |
| 14 | J2 | 1 | CONN HEADER VERT SGL 4POS GOLD | 961104-6404-AR | 3M |
| 15 | U1 | 1 | RF Amp | F0480 | IDT |
| 16 | | 1 | Printed Circuit Board | F0480 EVKIT | SBC |

APPLICATIONS INFORMATION

IDTF0480 has been optimized for use in high performance RF applications from 700 MHz to 2700 MHz.

Power Supplies

A common VCC power supply should be used for all pins requiring DC power. All supply pins should be bypassed with external capacitors to minimize noise and fast transients. Supply noise can degrade noise figure and fast transients can trigger ESD clamps and cause them to fail. Supply voltage change or transients should have a slew rate smaller than $1V/20\mu S$. In addition, all control pins should remain at 0V (+/-0.3V) while the supply voltage ramps or while it returns to zero.

Control Pin Interface

If control signal integrity is a concern and clean signals cannot be guaranteed due to overshoot, undershoot, ringing, etc., the following circuit at the input of each control pin is recommended. This applies to SPI and control pins 8, 9, 10, 11, 15, and 17 as shown below. Note the recommended resistor and capacitor values do not necessarily match the EV kit BOM for the case of poor control signal integrity. For multiple devices driven by a single control line, the component values will need to be adjusted accordingly so as not to overload the control line



TOP MARKINGS

