

PTFB093608FV

Thermally-Enhanced High Power RF LDMOS FET 360 W, 28 V, 920 – 960 MHz

Description

The PTFB093608FV is a 360 LDMOS FET intended for use in multi-standard cellular power amplifier applications in the 920 to 960 MHz frequency band. Features include input and output matching, high gain and thermally-enhanced package with earless flange. Manufactured with Wolfspeed's advanced LDMOS process, this device provides excellent thermal performance and superior reliability.

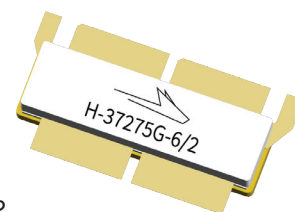

PTFB093608FV
Package H-37275G-6/2

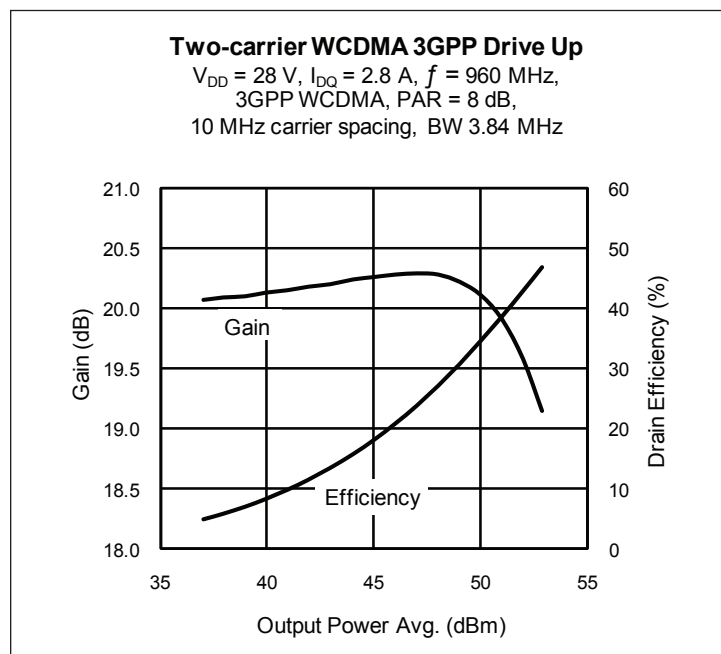

Features

- Broadband internal matching
- Enhanced for use in DPD error correction systems and Doherty applications
- Wide video bandwidth
- Typical two-carrier WCDMA performance, 960 MHz, 28 V
 - Average output power = 160 W
 - Gain = 19 dB
 - Efficiency = 40%
- Integrated ESD protection
- Low thermal resistance
- Capable of handling 10:1 VSWR @ 32 V, 960 MHz, +3 dB input overdrive = 500 W (CW) output power
- Pb-Free and RoHS compliant

RF Characteristics

Single-carrier WCDMA Specifications (tested in Wolfspeed test fixture)

$V_{DD} = 28\text{ V}$, $I_{DQ} = 2.8\text{ A}$, $P_{OUT} = 112\text{ W}$ average, $f = 960\text{ MHz}$, 3GPP signal, channel bandwidth = 3.84 MHz, PAR = 10 dB @ 0.01% CCDF probability

Characteristic	Symbol	Min	Typ	Max	Unit
Gain	G_{ps}	18	19	—	dB
Drain Efficiency	η_D	33.5	35	—	%
Adjacent Channel Power Ratio	ACPR	—	-33	-31	dBc

All published data at $T_{CASE} = 25^\circ\text{C}$ unless otherwise indicated

ESD: Electrostatic discharge sensitive device—observe handling precautions!

RF Characteristics (cont.)

Two-tone Specifications (not subject to production test—verified by design/characterization in WolfSpeed test fixture)
 $V_{DD} = 28\text{ V}$, $I_{DQ} = 2.8\text{ A}$, $P_{OUT} = 315\text{ W PEP}$, $f = 960\text{ MHz}$, tone spacing = 1 MHz

Characteristic	Symbol	Min	Typ	Max	Unit
Gain	G_{ps}	—	20	—	dB
Drain Efficiency	η_D	—	42	—	%
Intermodulation Distortion	IMD	—	-30	—	dBc

DC Characteristics

Characteristic	Conditions	Symbol	Min	Typ	Max	Unit
Drain-Source Breakdown Voltage	$V_{GS} = 0\text{ V}$, $I_{DS} = 10\text{ mA}$	$V_{(BR)DSS}$	65	—	—	V
Drain Leakage Current	$V_{DS} = 28\text{ V}$, $V_{GS} = 0\text{ V}$	I_{DSS}	—	—	1.0	μA
	$V_{DS} = 63\text{ V}$, $V_{GS} = 0\text{ V}$		—	—	10.0	μA
Gate Leakage Current	$V_{GS} = 10\text{ V}$, $V_{DS} = 0\text{ V}$	I_{GSS}	—	—	1.0	μA
On-State Resistance	$V_{GS} = 10\text{ V}$, $V_{DS} = 0.1\text{ V}$	$R_{DS(on)}$	—	0.05	—	Ω
Operating Gate Voltage	$V_{DS} = 28\text{ V}$, $I_{DQ} = 2.8\text{ A}$	V_{GS}	2.5	3.9	4.5	V

Maximum Ratings

Parameter	Symbol	Value	Unit
Drain-Source Voltage	V_{DSS}	65	V
Gate-Source Voltage	V_{GS}	-6 to +10	V
Junction Temperature	T_J	200	$^{\circ}\text{C}$
Storage Temperature Range	T_{STG}	-40 to +150	$^{\circ}\text{C}$
Thermal Resistance ($T_{CASE} = 70^{\circ}\text{C}$, 28 V, 360 W CW)	$R_{\theta JC}$	0.12	$^{\circ}\text{C/W}$

Ordering Information

Type and Version	Order Code	Package and Description	Shipping
PTFB093608FV V3 R0	PTFB093608FV-V3-R0	H-37275G-6/2, earless flange	Tape & Reel, 50 pcs
PTFB093608FV V3 R2	PTFB093608FV-V3-R2	H-37275G-6/2, earless flange	Tape & Reel, 250 pcs

Typical Performance (data taken in a production test fixture)

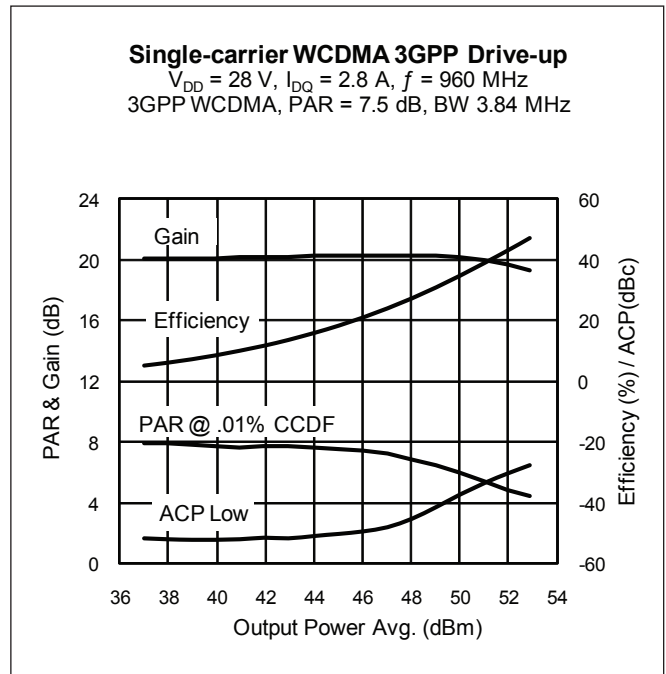
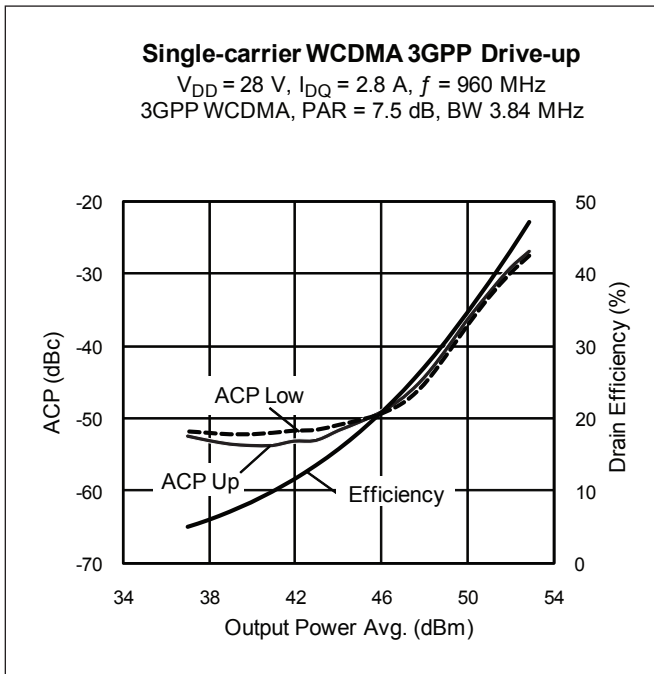
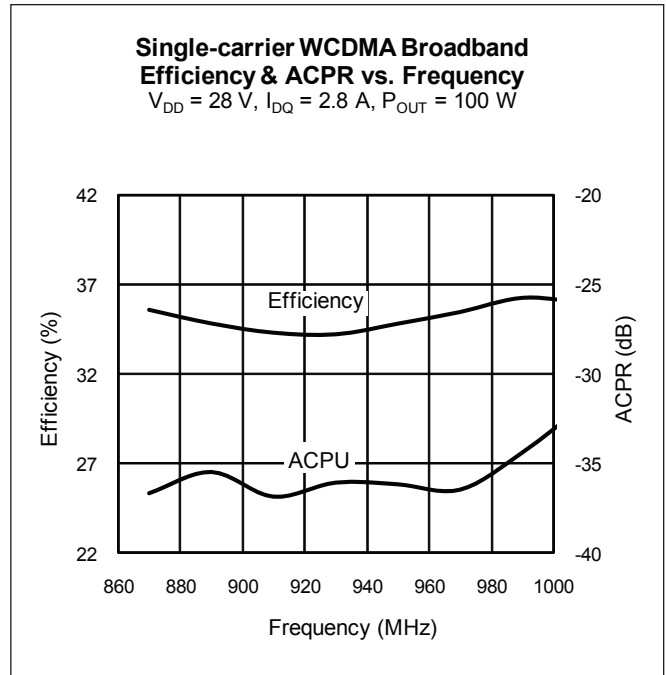
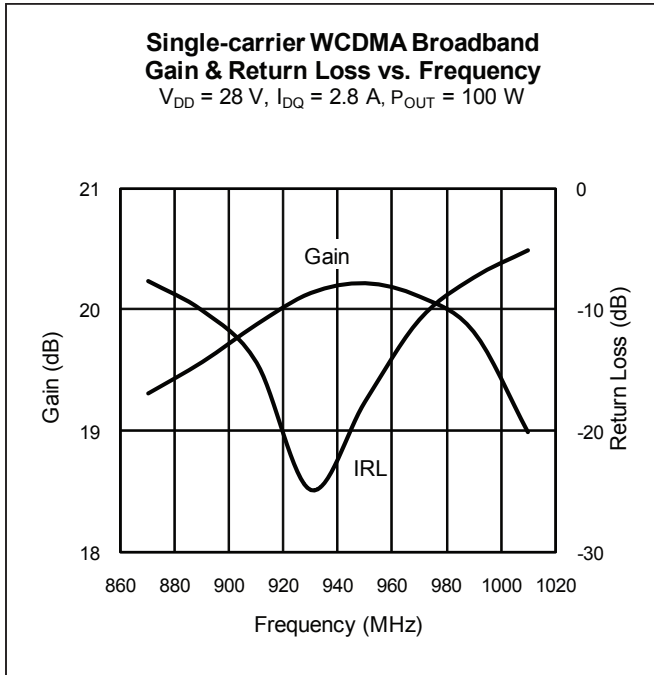

Typical Performance (cont.)

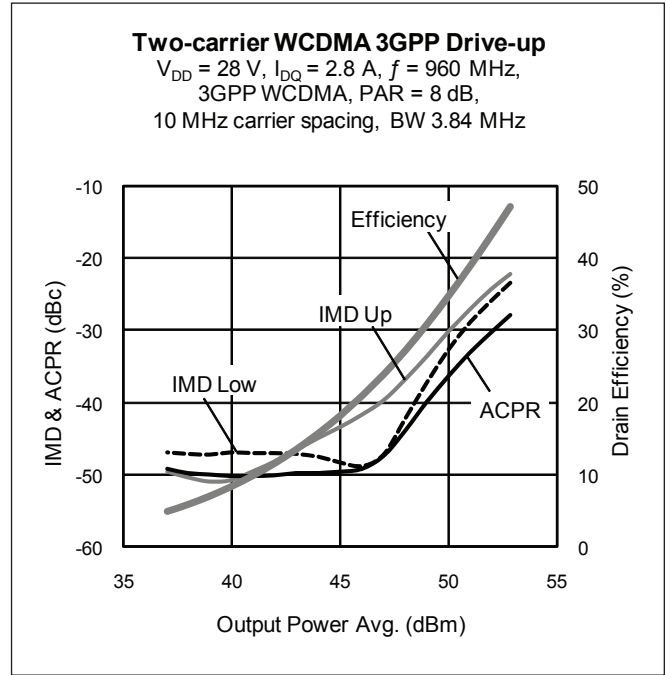
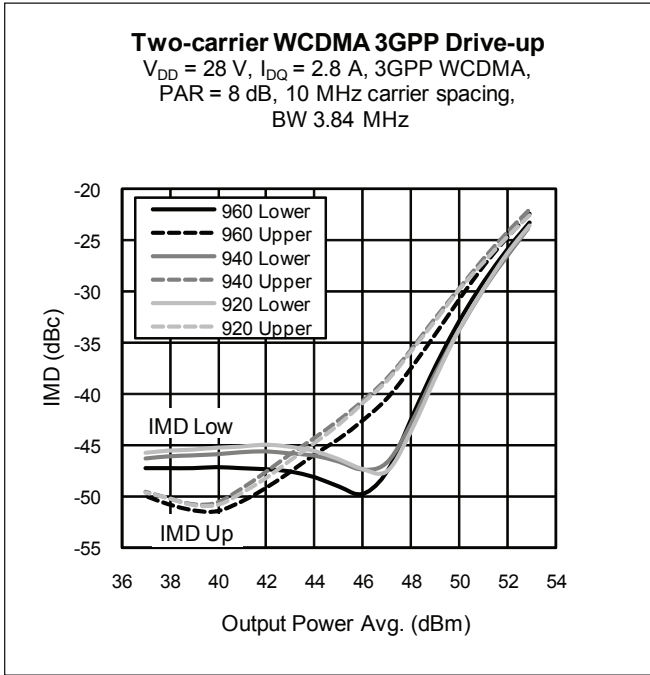

Broadband Circuit Impedance

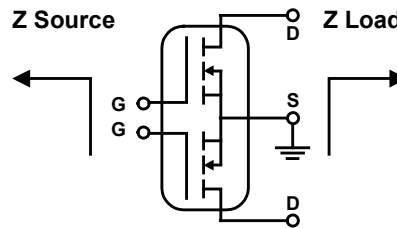

Frequency MHz	Z Source Ω		Z Load Ω	
	R	jX	R	jX
910	1.84	-1.74	0.89	-1.52
920	1.78	-1.73	0.86	-1.46
930	1.72	-1.72	0.83	-1.40
940	1.66	-1.71	0.81	-1.35
950	1.61	-1.69	0.79	-1.29
960	1.55	-1.66	0.77	-1.23
970	1.50	-1.64	0.75	-1.17

Alternative Peak-tune Load Pull Characteristics

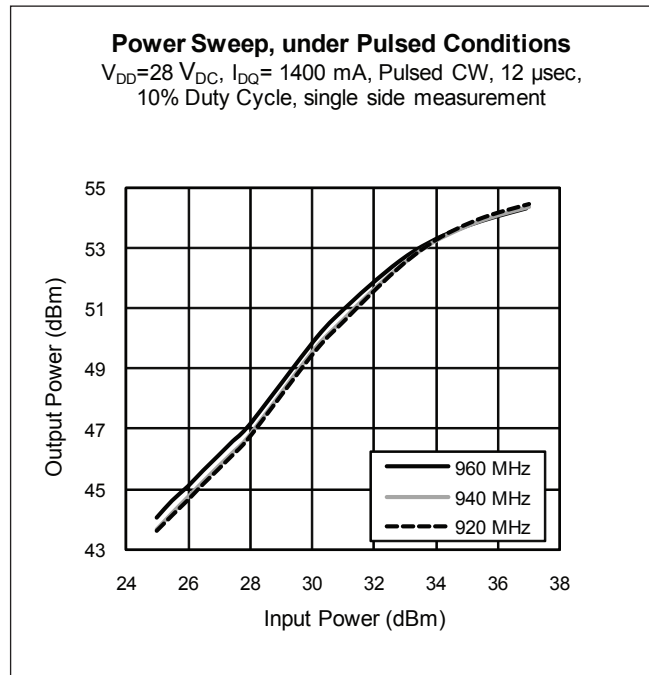

Frequency MHz	P _{1dB}	
	dBm	W
920	53.95	248
940	53.80	240
960	53.58	228

Impedance at P_{1dB}

Frequency MHz	Z Source Ω		Z Load Ω	
	R	jX	R	jX
920	3.76	-2.08	1.35	-2.42
940	4.99	-2.64	1.27	-2.48
960	4.72	-2.70	1.22	-2.42

Note: Load pull test fixture tuned for peak P_{1dB} output power at 28 V.
 Measurement on single side.

Reference Circuit

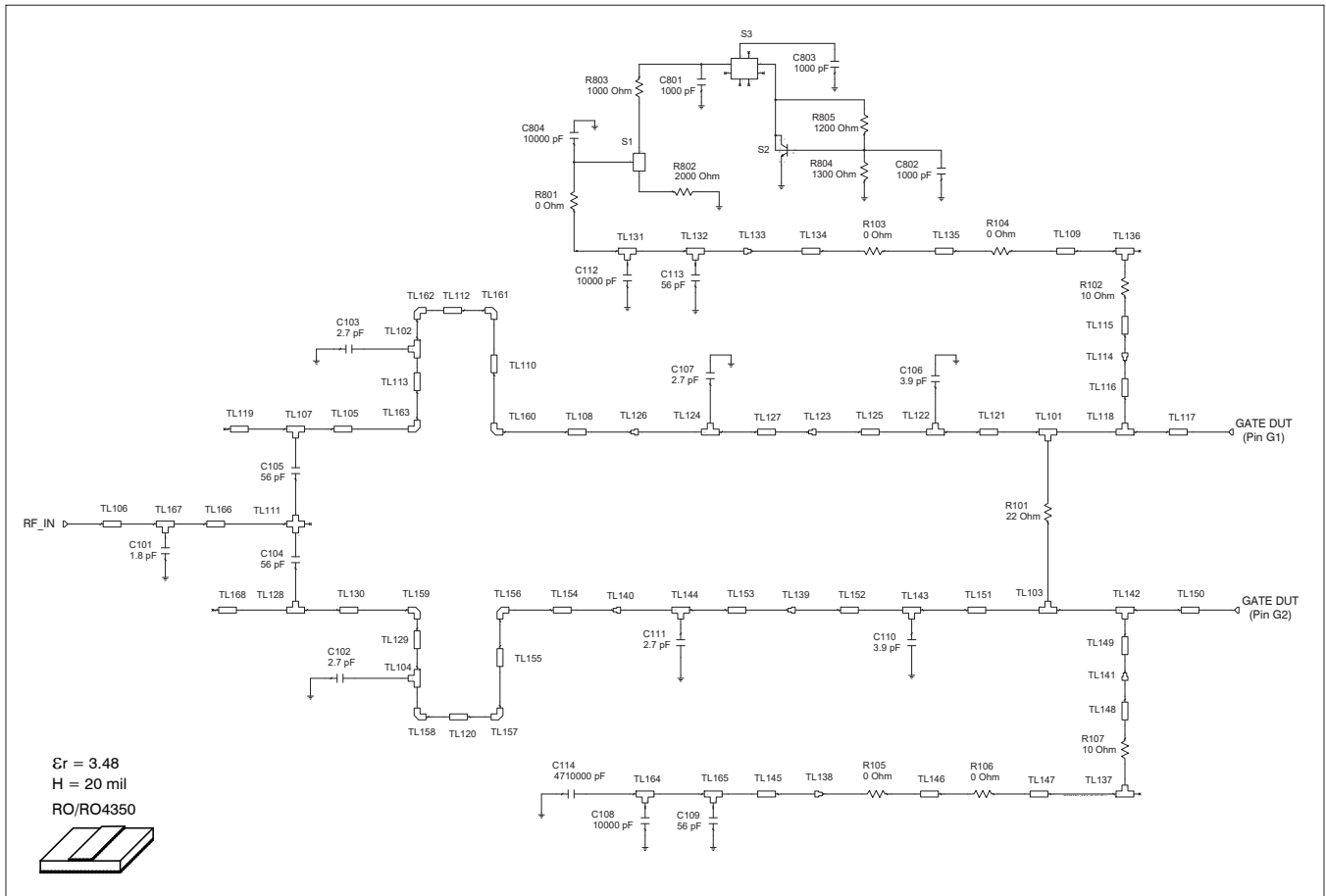

Reference circuit input schematic for $f = 960 \text{ MHz}$

Reference Circuit (cont.)

Description	
DUT	PTFB093608FV
PCB	0.508 mm [.020"] thick, er = 3.48, Rogers 4350, 1 oz. copper

Electrical Characteristics at 960 MHz

Transmission Line	Electrical Characteristics	Dimensions: mm	Dimensions: mils
Input			
TL101, TL103, TL122, TL143		W1 = 0.013, W2 = 0.013, W3 = 0.002	W1 = 13, W2 = 520, W3 = 60
TL102, TL104	0.001 λ , 51.98 Ω	W1 = 1.087, W2 = 1.087, W3 = 0.127	W1 = 43, W2 = 43, W3 = 5
TL105, TL130	0.005 λ , 51.98 Ω	W = 1.087, L = 0.914	W = 43, L = 36
TL106	0.034 λ , 51.98 Ω	W = 1.087, L = 6.431	W = 43, L = 253
TL107, TL128	0.000 λ , 51.98 Ω	W1 = 1.087, W2 = 1.087, W3 = 0.025	W1 = 43, W2 = 43, W3 = 1
TL108, TL154	0.034 λ , 51.98 Ω	W = 1.087, L = 6.342	W = 43, L = 250
TL109, TL147	0.006 λ , 34.08 Ω	W = 2.032, L = 1.016	W = 80, L = 40
TL110, TL155	0.042 λ , 51.98 Ω	W = 1.087, L = 8.026	W = 43, L = 316
TL111		W1 = 1.087, W2 = 1.829, W3 = 1.087, W4 = 1.829	W1 = 43, W2 = 72, W3 = 43, W4 = 72
TL112	0.013 λ , 51.98 Ω	W = 1.087, L = 2.543	W = 43, L = 100
TL113, TL129	0.033 λ , 51.98 Ω	W = 1.087, L = 6.198	W = 43, L = 244
TL114, TL141		W1 = 0.508, W2 = 2.896	W1 = 20, W2 = 114
TL115, TL148	0.011 λ , 26.07 Ω	W = 2.896, L = 2.032	W = 114, L = 80
TL116, TL149	0.026 λ , 78.27 Ω	W = 0.508, L = 5.080	W = 20, L = 200
TL117, TL150	0.024 λ , 7.03 Ω	W = 13.208, L = 4.064	W = 520, L = 160
TL118, TL142		W1 = 0.013, W2 = 0.013, W3 = 0.001	W1 = 13, W2 = 520, W3 = 20
TL119, TL168	0.006 λ , 51.98 Ω	W = 1.087, L = 1.143	W = 43, L = 45
TL120	0.013 λ , 51.98 Ω	W = 1.087, L = 2.550	W = 43, L = 100
TL121, TL151	0.015 λ , 7.03 Ω	W = 13.208, L = 2.591	W = 520, L = 102
TL123, TL139		W1 = 0.003, W2 = 0.013, Offset = 0.005	W1 = 3, W2 = 520, Offset = 192
TL124, TL144		W1 = 0.003, W2 = 0.003, W3 = 0.003	W1 = 3, W2 = 137, W3 = 110
TL125, TL152	0.095 λ , 7.03 Ω	W = 13.208, L = 16.434	W = 520, L = 647
TL126		W1 = 0.001, W2 = 0.003, Offset = 0.001	W1 = 1, W2 = 137, Offset = 47
TL127, TL153	0.041 λ , 22.60 Ω	W = 3.467, L = 7.356	W = 137, L = 290
TL131, TL132	0.010 λ , 19.85 Ω	W1 = 4.064, W2 = 4.064, W3 = 1.778	W1 = 160, W2 = 160, W3 = 70
TL133, TL138		W1 = 0.002, W2 = 0.004, Offset = -0.001	W1 = 2, W2 = 160, Offset = -40
TL134	0.014 λ , 34.08 Ω	W = 2.032, L = 2.540	W = 80, L = 100
TL135, TL146	0.092 λ , 34.08 Ω	W = 2.032, L = 17.018	W = 80, L = 670
TL136, TL137	0.016 λ , 34.08 Ω	W1 = 2.032, W2 = 2.032, W3 = 2.896	W1 = 80, W2 = 80, W3 = 114
TL140		W1 = 0.001, W2 = 0.003, Offset = 0.001	W1 = 1, W2 = 137, Offset = 47
TL145	0.014 λ , 18.88 Ω	W = 4.318, L = 2.540	W = 170, L = 100

table continued on page 9

Reference Circuit (cont.)

Electrical Characteristics at 960 MHz

Transmission Line	Electrical Characteristics	Dimensions: mm	Dimensions: mils
Input			
TL156, TL157, TL158, TL159, TL160, TL161, TL162, TL163		W = 1.087	W = 43
TL164, TL165	0.010 λ , 18.88 Ω	W1 = 4.318, W2 = 4.318, W3 = 1.778	W1 = 170, W2 = 170, W3 = 70
TL166	0.086 λ , 51.98 Ω	W = 1.087, L = 16.208	W = 43, L = 638
TL167	0.015 λ , 51.98 Ω	W1 = 1.087, W2 = 1.087, W3 = 2.794	W1 = 43, W2 = 43, W3 = 110
Output			
TL201		W1 = 1.087, W2 = 2.794, W3 = 1.087 W4 = 2.794	W1 = 43, W2 = 110, W3 = 43, W4 = 110
TL202		W1 = 1.087, W2 = 1.829, W3 = 1.087 W4 = 1.829	W1 = 43, W2 = 72, W3 = 43, W4 = 72
TL203, TL204, TL226		W1 = 0.013, W2 = 0.013, W3 = 0.002	W1 = 13, W2 = 520, W3 = 70
TL205, TL221	0.031 λ , 7.03 Ω	W = 13.208, L = 5.385	W = 520, L = 212
TL206, TL214	0.101 λ , 7.03 Ω	W = 13.208, L = 17.399	W = 520, L = 685
TL207	0.034 λ , 51.98 Ω	W = 1.087, L = 6.350	W = 43, L = 250
TL208, TL216	0.056 λ , 22.60 Ω	W = 3.467, L = 10.150	W = 137, L = 400
TL209, TL215	0.003 λ , 7.03 Ω	W = 13.208, L = 0.559	W = 520, L = 22
TL210	0.056 λ , 51.98 Ω	W = 1.087, L = 10.643	W = 43, L = 419
TL211	0.005 λ , 51.98 Ω	W = 1.087, L = 0.927	W = 43, L = 37
TL212	0.033 λ , 51.98 Ω	W = 1.087, L = 6.327	W = 43, L = 249
TL213, TL243	0.006 λ , 51.98 Ω	W = 1.087, L = 1.156	W = 43, L = 46
TL217	0.034 λ , 51.98 Ω	W = 1.087, L = 6.342	W = 43, L = 250
TL218	0.033 λ , 51.98 Ω	W = 1.087, L = 6.322	W = 43, L = 249
TL219	0.005 λ , 51.98 Ω	W = 1.087, L = 0.927	W = 43, L = 37
TL220, TL254	0.005 λ , 51.98 Ω	W = 1.087, L = 1.016	W = 43, L = 40
TL222, TL241	0.006 λ , 20.93 Ω	W = 3.810, L = 1.016	W = 150, L = 40
TL223, TL249	0.003 λ , 20.93 Ω	W1 = 3.810, W2 = 3.810, W3 = 0.508	W1 = 150, W2 = 150, W3 = 20
TL224, TL250	0.021 λ , 20.93 Ω	W1 = 3.810, W2 = 3.810, W3 = 3.810	W1 = 150, W2 = 150, W3 = 150
TL225, TL235	0.037 λ , 20.93 Ω	W = 3.810, L = 6.604	W = 150, L = 260
TL227, TL228	0.001 λ , 51.98 Ω	W1 = 1.087, W2 = 1.087, W3 = 0.127	W1 = 43, W2 = 43, W3 = 5
TL229, TL231		W1 = 0.013, W2 = 0.003, Offset = 0.005	W1 = 13, W2 = 137, Offset = 192
TL230, TL232		W1 = 0.003, W2 = 0.001, Offset = 0.001	W1 = 3, W2 = 43, Offset = 47
TL233, TL242, TL244, TL256		W1 = 0.001, W2 = 0.001, W3 = 0.003	W1 = 1, W2 = 43, W3 = 120
TL234		W1 = 0.013, W2 = 0.013, W3 = 0.002	W1 = 13, W2 = 520, W3 = 70
TL236, TL251	0.040 λ , 20.93 Ω	W = 3.810, L = 7.112	W = 150, L = 280
TL237, TL246	0.028 λ , 20.93 Ω	W1 = 3.810, W2 = 3.810, W3 = 5.080	W1 = 150, W2 = 150, W3 = 200

table continued on page 10



Reference Circuit (cont.)

Electrical Characteristics at 960 MHz

Transmission Line	Electrical Characteristics	Dimensions: mm	Dimensions: mils
Output			
TL238, TL252	0.011 λ , 20.93 Ω	W = 3.810, L = 2.032	W = 150, L = 80
TL239, TL247	0.014 λ , 20.93 Ω	W1 = 3.810, W2 = 3.810, W3 = 2.540	W1 = 150, W2 = 150, W3 = 100
TL240, TL248	0.011 λ , 20.93 Ω	W1 = 3.810, W2 = 3.810, W3 = 2.032	W1 = 150, W2 = 150, W3 = 80
TL245	0.020 λ , 51.98 Ω	W = 1.087, L = 3.825	W = 43, L = 151
TL253	0.064 λ , 51.98 Ω	W = 1.087, L = 11.996	W = 43, L = 472
TL255	0.020 λ , 51.98 Ω	W = 1.087, L = 3.820	W = 43, L = 150
TL257, TL258, TL259, TL260, TL261, TL262, TL263, TL264		W = 1.087	W = 43

Circuit Assembly Information

Test Fixture Part No. LTN/PTFB093608FV

Find Gerber files for this test fixture on the Wolfspeed Web site at www.wolfspeed.com/RF

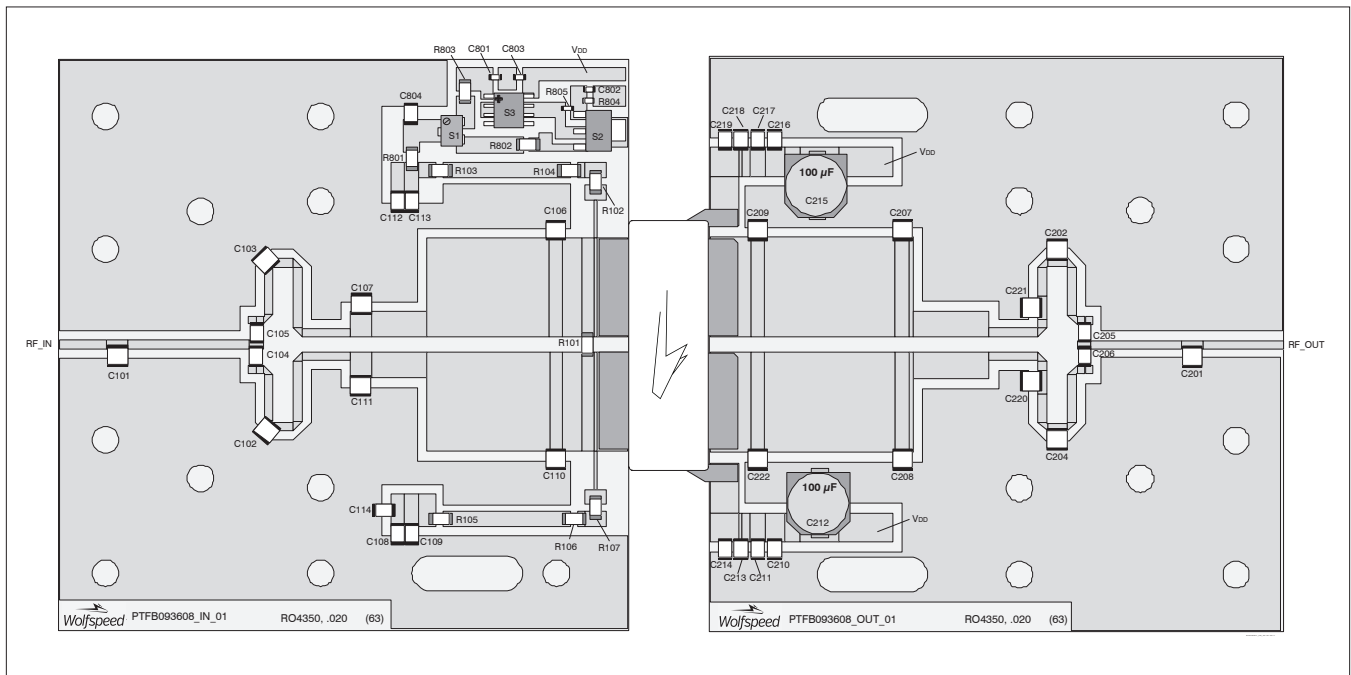

Reference circuit assembly diagram (not to scale)

Reference Circuit (cont.)

Components Information

Component	Description	Manufacturer/Supplier	P/N
Input			
C101	Chip capacitor, 1.8 pF	ATC	ATC100B1R8BW500XB
C102, C103	Chip capacitor, 2.7 pF	ATC	ATC100B2R7BW500XB
C104, C105, C109, C113	Chip capacitor, 56 pF	ATC	ATC100B560JW500XB
C106, C110	Chip capacitor, 3.9 pF	ATC	ATC100B3R9CW500XB
C107, C111	Chip capacitor, 2.7 pF	ATC	ATC100B2R7CW500XB
C108, C112, C804	Chip capacitor, 10000 pF	ATC	ATC200B103MW
C114	Chip capacitor, 4.71 μ F	Digi-Key	493-2372-2-ND
C801, C802, C803	Chip capacitor, 1000 pF	Digi-Key	PCC1772CT-ND
R101	Resistor, 22 Ω	Digi-Key	P22ECT-ND
R102, R107	Resistor, 10 Ω	Digi-Key	P10ECT-ND
R103, R104, R105, R106, R801	Resistor, 0 Ω	Digi-Key	P0ECT-ND
R802	Resistor, 2000 Ω	Digi-Key	P2.0KECT-ND
R803	Resistor, 1000 Ω	Digi-Key	P1.0KECT-ND
R804	Resistor, 1300 Ω	Digi-Key	P1.3KGCT-ND
R805	Resistor, 1200 Ω	Digi-Key	P1.2KGCT-ND
S1	Potentiometer, 2k Ω	Digi-Key	3224W-202ECT-ND
S2	Transistor	Digi-Key	BCP56-ND
S3	Voltage Regulator	Digi-Key	LM78L05ACM-ND
Output			
C201	Chip capacitor, 3.3 pF	ATC	ATC100B3R3BW500XB
C202, C204	Chip capacitor, 1.8 pF	ATC	ATC100B1R8BW500XB
C220, C221	Chip capacitor, 2.2 pF	ATC	ATC100B2R2BW500XB
C205, C206	Chip capacitor, 56 pF	ATC	ATC100B560JW500XB
C207, C208	Chip capacitor, 3.3 pF	ATC	ATC100B3R3BW500XB
C209, C222	Chip capacitor, 4.7 pF	ATC	ATC100B4R7BW500XB
C210, C211, C216, C217	Chip capacitor, 4.71 μ F	Digi-Key	490-1864-2-ND
C212, C215	Capacitor, 100 μ F	Digi-Key	PCE4442TR-ND
C213, C214, C218, C219	Capacitor, 10 μ F	Digi-Key	587-1818-2-ND

Pinout Diagram (top view)

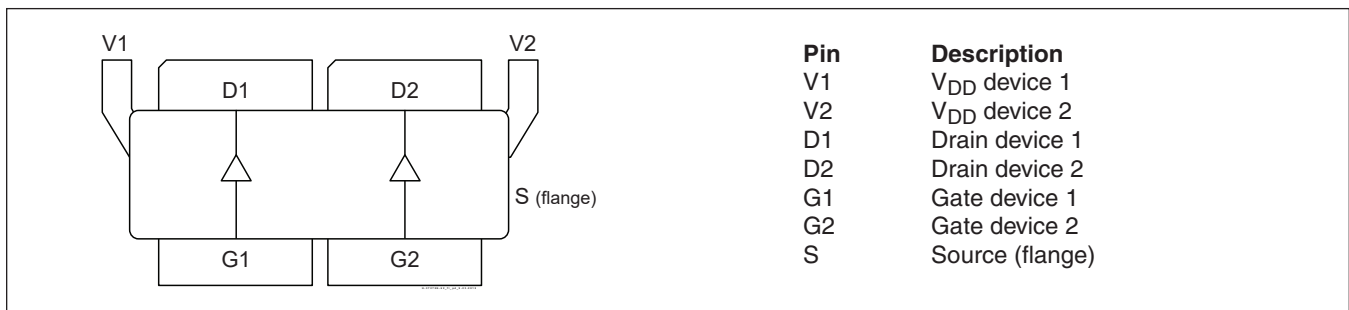

Package Outline Specifications

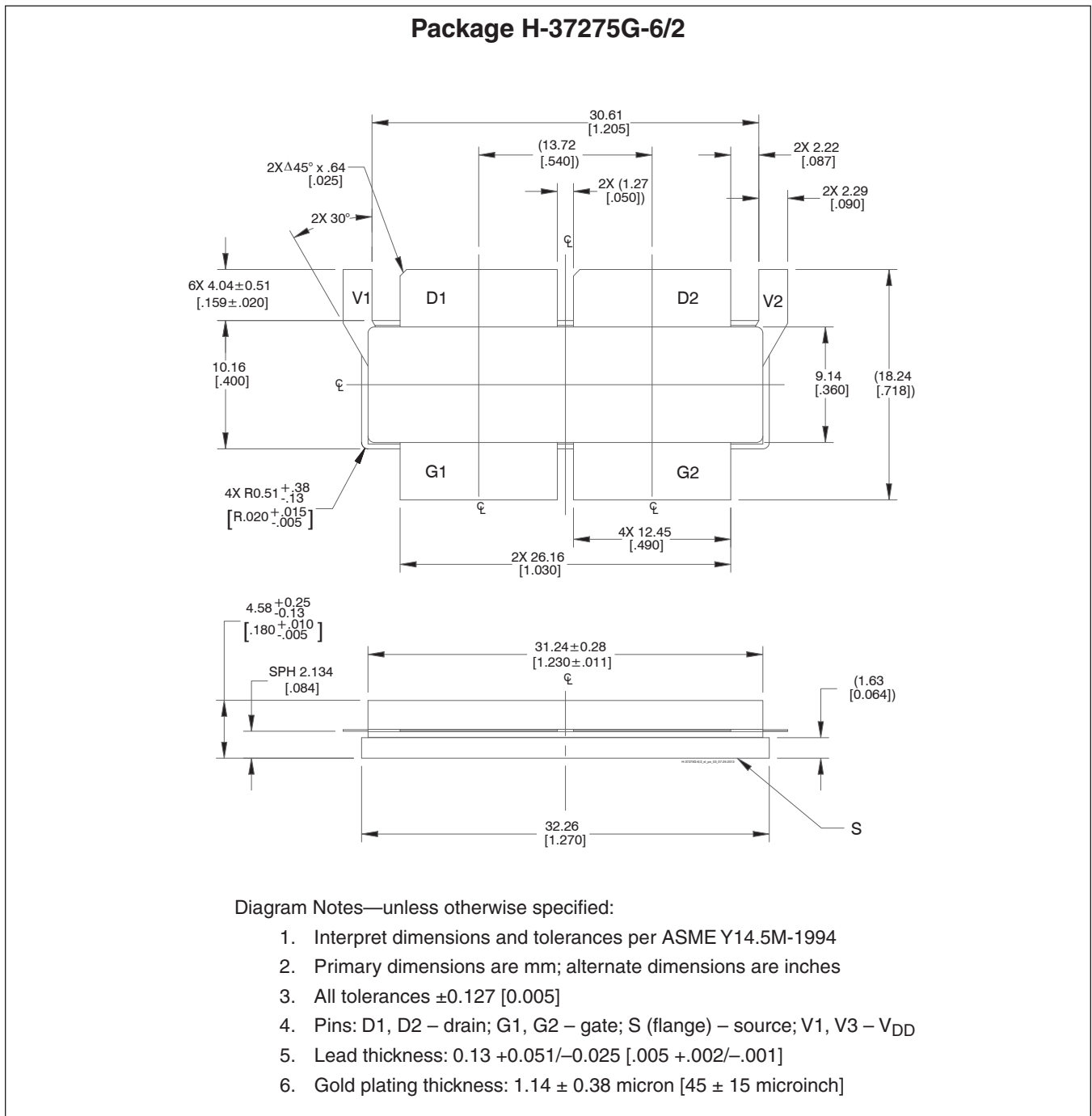

Revision History

Revision	Date	Data Sheet Type	Page	Subjects (major changes since last revision)
01	2011-01-25	Advance	All	Advance information for proposed product.
02	2011-06-27	Production	All	Product released: Specifications updated, set; circuit and other information added.
02.1	2011-07-26	Production	1	Typo corrected
03	2011-09-06	Production	2	Updated storage temperature range
04	2012-07-24	Production	All 2	Package change (all package information updated), product Version now V2 Added order code in ordering information table
05	2015-10-06	Production	All 1, 2, 12 2	Product is now Version 3. Package changed from H-34275G-6/2 to H-37275G-6/2 Shipping options changed, tray no longer available.
06	2018-06-22	Production	All	Converted to Wolfspeed Data Sheet

For more information, please contact:

4600 Silicon Drive
Durham, North Carolina, USA 27703
www.wolfspeed.com/RF

Sales Contact
RFSales@wolfspeed.com

RF Product Marketing Contact
RFMarketing@wolfspeed.com
919.407.7816

Notes

Disclaimer

Specifications are subject to change without notice. Cree, Inc. believes the information contained within this data sheet to be accurate and reliable. However, no responsibility is assumed by Cree for any infringement of patents or other rights of third parties which may result from its use. No license is granted by implication or otherwise under any patent or patent rights of Cree. Cree makes no warranty, representation or guarantee regarding the suitability of its products for any particular purpose. "Typical" parameters are the average values expected by Cree in large quantities and are provided for information purposes only. These values can and do vary in different applications and actual performance can vary over time. All operating parameters should be validated by customer's technical experts for each application. Cree products are not designed, intended or authorized for use as components in applications intended for surgical implant into the body or to support or sustain life, in applications in which the failure of the Cree product could result in personal injury or death or in applications for planning, construction, maintenance or direct operation of a nuclear facility.