

40 A Snubberless™ Triac

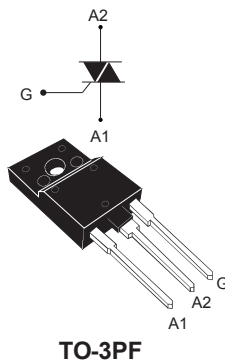

Features

- High current Triac
- High surge current = 400 A
- Max. blocking voltage = V_{DRM} , V_{RRM} = 600 V
- Max. surge voltage = V_{DSM} , V_{RSM} = 700 V
- I_{GT} maximum = 50 mA
- High static and dynamic commutation:
 - $(di/dt)_c$ = 25.1 A/ms
 - dV/dt = 1000 V/ μ s
- UL1557 certified (file ref. 81734) = 2.5 kV
- Snubberless™ device
- ECOPACK®2 compliant (RoHS and HF compliance)

Applications

- Heater, ventilation and air conditioning (HVAC)
- Solid state relay (SSR)
- Motor soft starter
- SMPS inrush current limiter

Description

The device is packaged in a through-hole TO-3PF full plastic insulated.

The T4050-6PF is optimized for the ON/OFF function or phase angle control in applications such as static relays, heating regulation, induction motor starting circuits, light dimmers, motor speed controllers and in many other industrial applications where high immunity and high surge current are required.

Product status link	
T4050-6PF	
Product summary	
$I_{T(RMS)}$	40 A
V_{DRM} , V_{RRM}	600 V
V_{DSM} , V_{RSM}	700 V
I_{GT}	50 mA

1 Characteristics

Table 1. Absolute maximum ratings (limiting values)

Symbol	Parameter	Value	Unit
$I_{T(RMS)}$	RMS on-state current (full sine wave)	$T_c = 76\text{ °C}$	40 A
I_{TSM}	Non repetitive surge peak on-state current (full cycle, T_j initial = 25 °C)	$t = 16.7\text{ ms}$	420
		$t = 20\text{ ms}$	400
I^2t	I^2t value for fusing	$t_p = 10\text{ ms}$	1000 A ² s
di/dt	Critical rate of rise of on-state current, $I_G = 2 \times I_{GT}$, $tr \leq 100\text{ ns}$	$F = 120\text{ Hz}$, $T_j = 25\text{ °C}$	50 A/ μ s
V_{DRM}/V_{RRM}	Repetitive peak off-state voltage (50-60 Hz)		600 V
V_{DSM}/V_{RSM}	Non repetitive peak off-state voltage	$t_p = 10\text{ ms}$, $T_j = 25\text{ °C}$	700 V
I_{GM}	Peak gate current	$t_p = 20\text{ }\mu\text{s}$, $T_j = 125\text{ °C}$	8 A
V_{GM}	Peak gate voltage		8 V
$P_{G(AV)}$	Average gate power dissipation	$T_j = 125\text{ °C}$	1 W
$V_{ins.}$	Insulation RMS voltage, 1 minute (UL1557 file E81734)		2.5 kV
T_{stg}	Storage temperature range		-40 to +150 °C
T_j	Operating junction temperature range		-40 to +125 °C
T_L	Maximum lead temperature for soldering during 10 s		260 °C

Table 2. Electrical characteristics ($T_j = 25\text{ °C}$, unless otherwise specified)

Symbol	Test conditions	Quadrants; T_j	Value	Unit
$I_{GT}^{(1)}$	$V_D = 12\text{ V}$, $R_L = 33\text{ }\Omega$	I - II - III	Max.	50
V_{GT}			Max.	1.3
V_{GD}	$V_D = 600\text{ V}$, $R_L = 3.3\text{ k}\Omega$	I - II - III $T_j = 125\text{ °C}$	Min.	0.2
I_L	$I_G = 1.2 \times I_{GT}$	I - III	Max.	70
		II	Max.	160
$I_H^{(2)}$	$I_T = 500\text{ mA}$, gate open		Max.	85
$dV/dt^{(2)}$	$V_D = 402\text{ V}$, gate open	$T_j = 125\text{ °C}$	Min.	1000
$(di/dt)_c^{(2)}$	Snubberless™ ($dV/dt)_c > 20\text{ V}/\mu\text{s}$	$T_j = 125\text{ °C}$	Min.	25.1

1. Minimum I_{GT} is guaranteed at 5% of $I_{GT\text{ max}}$

2. For both polarities of A2 referenced to A1.

Table 3. Static electrical characteristics

Symbol	Test conditions	T_j		Value	Unit
$V_{TM}^{(1)}$	$I_{TM} = 60 \text{ A}$, $t_p = 380 \mu\text{s}$	25 °C	Max.	1.4	V
$V_{TO}^{(1)}$	Threshold voltage	125 °C	Max.	0.85	V
$R_D^{(1)}$	Dynamic resistance	125 °C	Max.	10	mΩ
I_{DRM}/I_{RRM}	$V_{DRM} = V_{RRM} = 600 \text{ V}$	25 °C	Max.	5	μA
		125 °C		7.5	mA

1. For both polarities of A2 referenced to A1.

Table 4. Thermal resistance

Symbol	Parameter		Value	Unit
$R_{th(j-c)}$	Junction to case (AC)	Max.	1.45	°C/W
		Typ.	1.1	
$R_{th(j-a)}$	Junction to ambient	Typ.	50	

1.1 Characteristics (curves)

Figure 1. Maximum power dissipation versus on-state RMS current

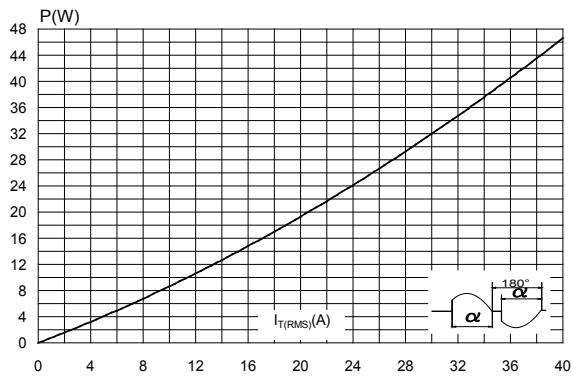

Figure 2. On-state RMS current versus case temperature

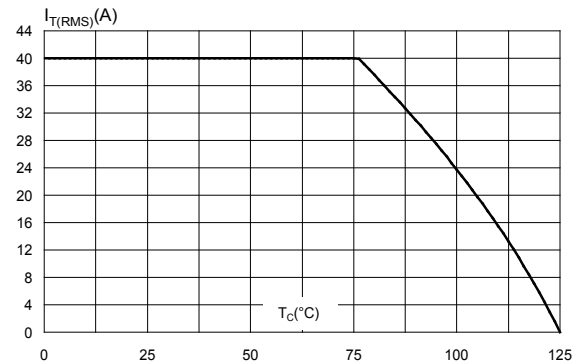

Figure 3. On-state RMS current versus ambient temperature (free air convection)

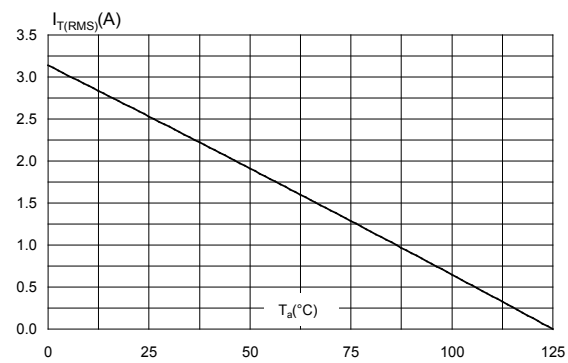

Figure 4. Relative variation of thermal impedance versus pulse duration

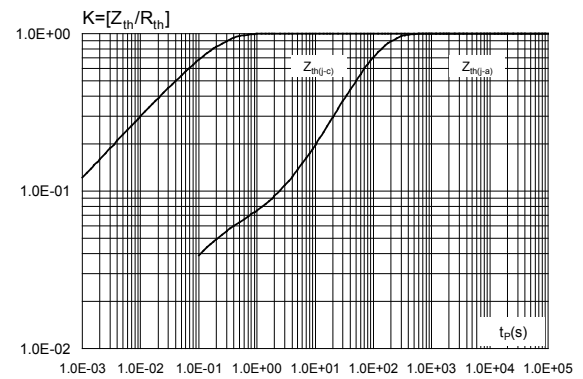

Figure 5. Relative variation of gate trigger voltage and current versus junction temperature (typical values)

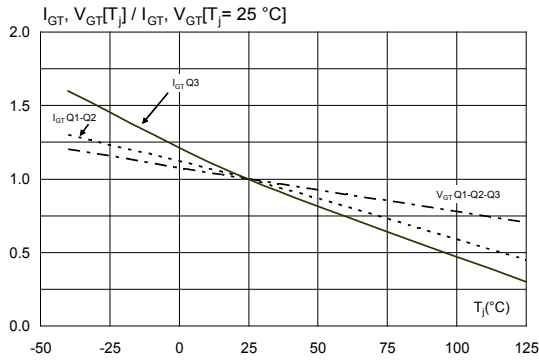

Figure 6. Relative variation of holding current and latching current versus junction temperature (typical values)

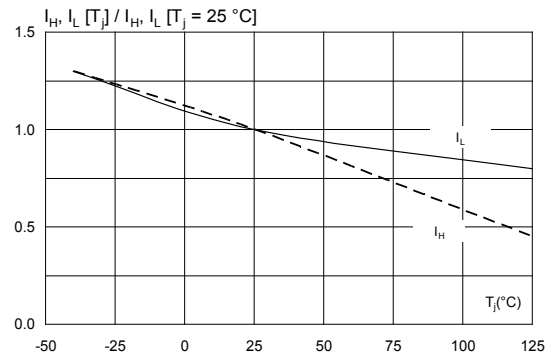

Figure 7. Relative variation of static dV/dt immunity versus junction temperature

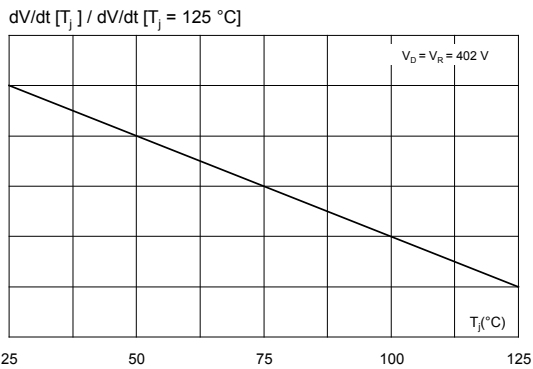

Figure 8. Relative variation of critical rate of decrease of main current versus junction temperature

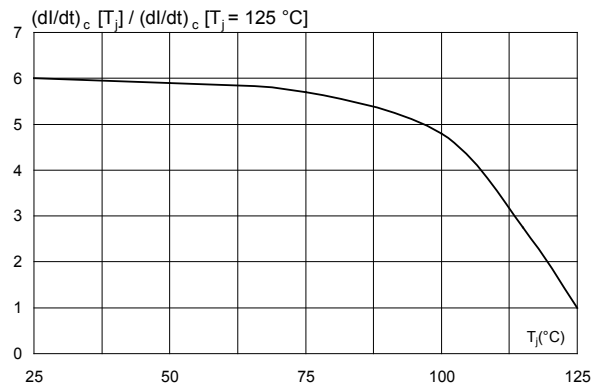

Figure 9. Surge peak on-state current versus number of cycles

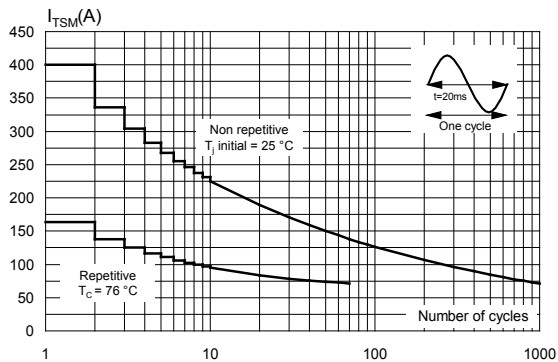

Figure 10. Non repetitive surge peak on-state current for a sinusoidal pulse with width $t_p < 10$ ms

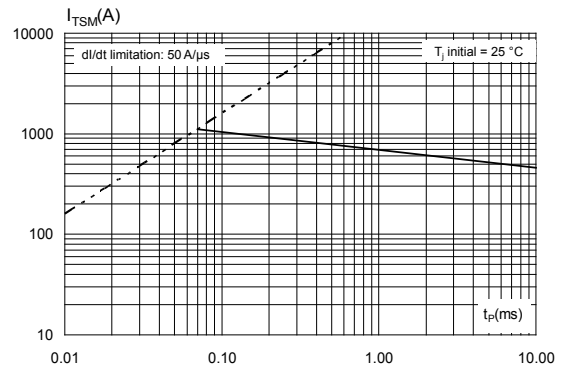

Figure 11. On-state characteristics (maximum values)

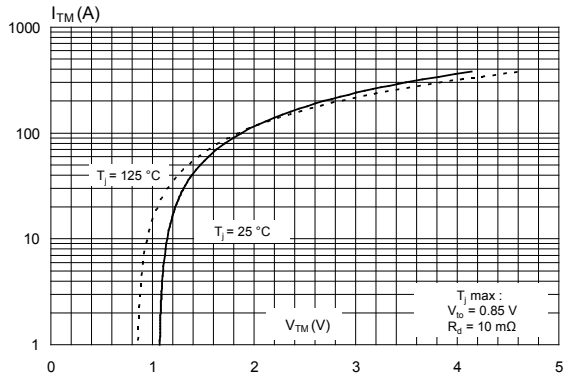
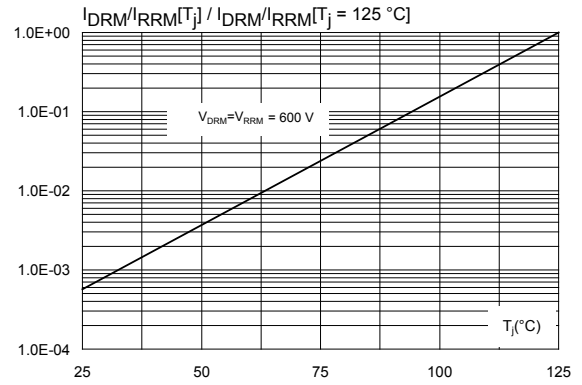

Figure 12. Relative variation of Leakage current versus junction temperature



2 Package information

In order to meet environmental requirements, ST offers these devices in different grades of ECOPACK® packages, depending on their level of environmental compliance. ECOPACK® specifications, grade definitions and product status are available at: www.st.com. ECOPACK® is an ST trademark.

2.1 TO-3PF package information

- Epoxy meets UL94, V0
- Lead-free package and HF package
- Recommended torque: 0.8N·m (max. 1.0 N·m)

Figure 13. TO-3PF package outline

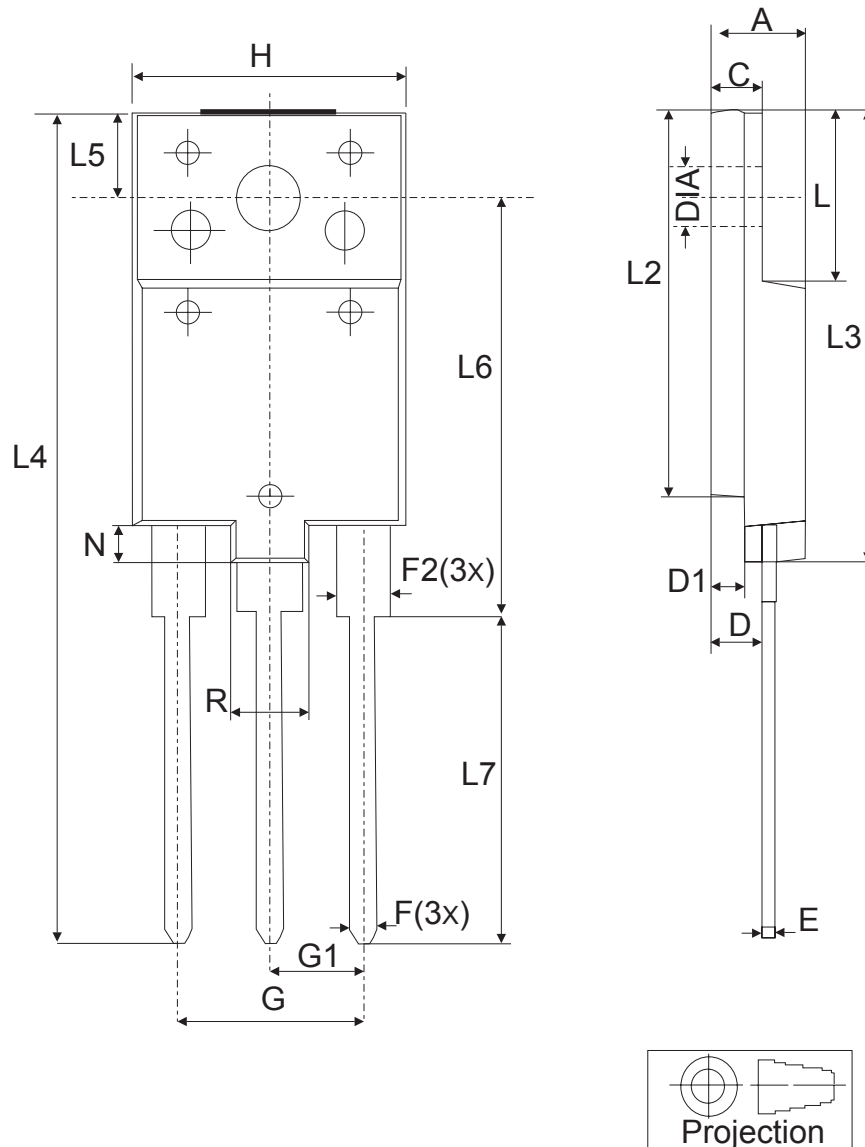

Table 5. TO-3PF mechanical data

Ref.	Dimensions					
	mm			Inches ⁽¹⁾		
	Min.	Typ.	Max.	Min.	Typ.	Max.
A	5.30		5.70	0.2087		0.2244
C	2.80		3.20	0.1102		0.1260
D	3.10		3.50	0.1220		0.1378
D1	1.80		2.20	0.0709		0.0866
E	0.80		1.10	0.0315		0.0433
F	0.65		0.95	0.0256		0.0374
F2	1.80		2.20	0.0709		0.0866
G	10.30		11.50	0.4055		0.4528
G1		5.45			0.2146	
H	15.30		15.70	0.6024		0.6181
L	9.80	10.00	10.20	0.3858	0.3937	0.4016
L2	22.80		23.20	0.8976		0.9134
L3	26.30		26.70	1.0354		0.0512
L4	43.20		44.40	1.7008		1.7480
L5	4.30		4.70	0.1693		0.1850
L6	24.30		24.70	0.9567		0.9724
L7	14.60		15.00	0.5748		0.5906
N	1.80		2.20	0.0709		0.0866
R	3.80		4.20	0.1496		0.1654
Dia	3.40		3.80	0.1339		0.1496

1. Inches given for reference only

3 Ordering information

Figure 14. Ordering information scheme

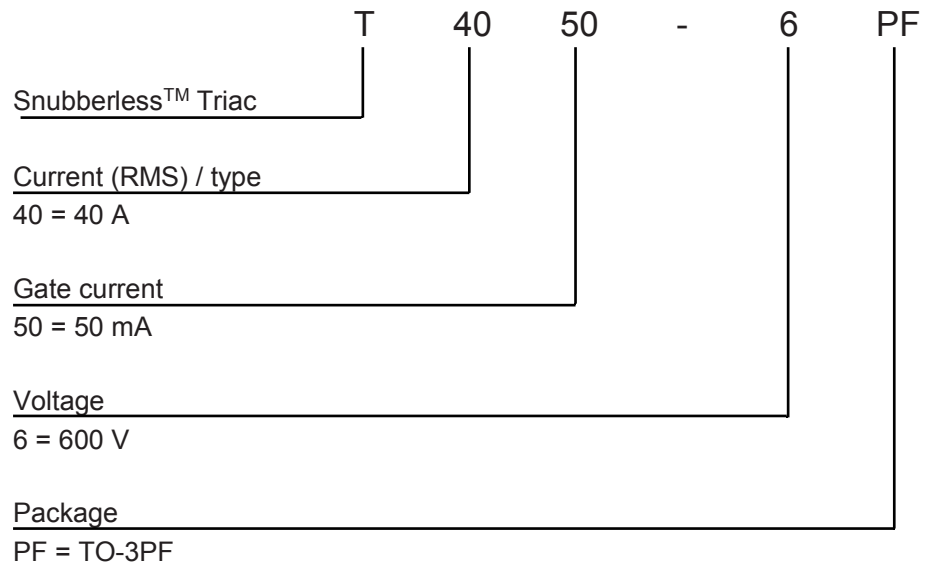

Table 6. Ordering information

Order code	Marking	Package	Weight	Base qty.	Delivery mode
T4050-6PF	T4050-6PF	TO-3PF	5.2 g	30	Tube

Revision history

Table 7. Document revision history

Date	Version	Changes
03-Dec-2018	1	Initial release.

IMPORTANT NOTICE – PLEASE READ CAREFULLY

STMicroelectronics NV and its subsidiaries (“ST”) reserve the right to make changes, corrections, enhancements, modifications, and improvements to ST products and/or to this document at any time without notice. Purchasers should obtain the latest relevant information on ST products before placing orders. ST products are sold pursuant to ST’s terms and conditions of sale in place at the time of order acknowledgement.

Purchasers are solely responsible for the choice, selection, and use of ST products and ST assumes no liability for application assistance or the design of Purchasers’ products.

No license, express or implied, to any intellectual property right is granted by ST herein.

Resale of ST products with provisions different from the information set forth herein shall void any warranty granted by ST for such product.

ST and the ST logo are trademarks of ST. All other product or service names are the property of their respective owners.

Information in this document supersedes and replaces information previously supplied in any prior versions of this document.

© 2018 STMicroelectronics – All rights reserved