

## FAST IGBT & FRED

The Fast IGBT is a new generation of high voltage power IGBTs. Using Non-Punch through technology, the Fast IGBT combined with an APT free wheeling Ultra Fast Recovery Epitaxial Diode (FRED) offers superior ruggedness and fast switching speed.

- Low Forward Voltage Drop
- High Freq. Switching to 20KHz
- RBSOA and SCSOA Rated
- Ultra Low Leakage Current
- Ultrafast Soft Recovery Anti-parallel Diode

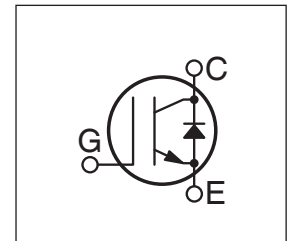

### MAXIMUM RATINGS

All Ratings:  $T_C = 25^\circ\text{C}$  unless otherwise specified.

| Symbol         | Parameter   | APT60GF120JRDQ3 | UNIT  |
|----------------|---|-----------------|-------|
| $V_{CES}$      | Collector-Emitter Voltage                                 | 1200            | Volts |
| $V_{GE}$       | Gate-Emitter Voltage                                      | $\pm 30$        |       |
| $I_{C1}$       | Continuous Collector Current @ $T_C = 25^\circ\text{C}$   | 149             | Amps  |
| $I_{C2}$       | Continuous Collector Current @ $T_C = 100^\circ\text{C}$  | 79              |       |
| $I_{CM}$       | Pulsed Collector Current <sup>①</sup>                     | 300             |       |
| SSOA           | Switching Safe Operating Area @ $T_J = 150^\circ\text{C}$ | 300A @ 1200V    |       |
| $P_D$          | Total Power Dissipation                                   | 625             | Watts |
| $T_J, T_{STG}$ | Operating and Storage Junction Temperature Range          | -55 to 150      |       |

### STATIC ELECTRICAL CHARACTERISTICS

| Symbol        | Characteristic / Test Conditions  | MIN  | TYP | MAX       | Units |
|---------------|---|------|-----|-----------|-------|
| $V_{(BR)CES}$ | Collector-Emitter Breakdown Voltage ( $V_{GE} = 0V, I_C = 350\mu\text{A}$ )                       | 1200 |     |           | Volts |
| $V_{GE(TH)}$  | Gate Threshold Voltage ( $V_{CE} = V_{GE}, I_C = 500\mu\text{A}, T_J = 25^\circ\text{C}$ )        | 4.5  | 5.5 | 6.5       |       |
| $V_{CE(ON)}$  | Collector-Emitter On Voltage ( $V_{GE} = 15V, I_C = 100A, T_J = 25^\circ\text{C}$ )               |      | 2.5 | 3.0       |       |
|               | Collector-Emitter On Voltage ( $V_{GE} = 15V, I_C = 100A, T_J = 125^\circ\text{C}$ )              |      | 3.1 |           |       |
| $I_{CES}$     | Collector Cut-off Current ( $V_{CE} = 1200V, V_{GE} = 0V, T_J = 25^\circ\text{C}$ ) <sup>②</sup>  |      |     | 0.35      | mA    |
|               | Collector Cut-off Current ( $V_{CE} = 1200V, V_{GE} = 0V, T_J = 125^\circ\text{C}$ ) <sup>②</sup> |      |     | 3.0       |       |
| $I_{GES}$     | Gate-Emitter Leakage Current ( $V_{GE} = \pm 20V$ )   |      |     | $\pm 100$ | nA    |

 **CAUTION:** These Devices are Sensitive to Electrostatic Discharge. Proper Handling Procedures Should Be Followed.

## DYNAMIC CHARACTERISTICS

APT60GF120JRDQ3

| Symbol       | Characteristic                                     | Test Conditions  | MIN | TYP  | MAX | UNIT |
|--------------|--|--|-----|------|-----|------|
| $C_{ies}$    | Input Capacitance                                  | <b>Capacitance</b><br>$V_{GE} = 0V, V_{CE} = 25V$<br>$f = 1 \text{ MHz}$   |     | 7080 |     | pF   |
| $C_{oes}$    | Output Capacitance                                 |  |     | 785  |     |      |
| $C_{res}$    | Reverse Transfer Capacitance                       |  |     | 435  |     |      |
| $V_{GEP}$    | Gate-to-Emitter Plateau Voltage                    | Gate Charge  |     | 10.0 |     | V    |
| $Q_g$        | Total Gate Charge <sup>③</sup>                     | $V_{GE} = 15V$   |     | 685  |     | nC   |
| $Q_{ge}$     | Gate-Emitter Charge                                | $V_{CE} = 600V$  |     | 80   |     |      |
| $Q_{gc}$     | Gate-Collector ("Miller") Charge                   | $I_C = 100A$   |     | 420  |     |      |
| SSOA         | Switching Safe Operating Area                      | $T_J = 150^\circ C, R_G = 1.0\Omega, V_{GE} = 15V, L = 100\mu H, V_{CE} = 1200V$   | 300 |      |     | A    |
| $t_{d(on)}$  | Turn-on Delay Time                                 | <b>Inductive Switching (25°C)</b><br>$V_{CC} = 800V$<br>$V_{GE} = 15V$<br>$I_C = 100A$<br>$R_G = 1.0\Omega$<br>$T_J = +25^\circ C$   |     | 44   |     | ns   |
| $t_r$        | Current Rise Time                                  |  |     | 100  |     |      |
| $t_{d(off)}$ | Turn-off Delay Time                                |  |     | 460  |     |      |
| $t_f$        | Current Fall Time                                  |  |     | 38   |     | mJ   |
| $E_{on1}$    | Turn-on Switching Energy <sup>④</sup>              |  |     | 14.6 |     |      |
| $E_{on2}$    | Turn-on Switching Energy (With Diode) <sup>⑤</sup> |  |     | 16.4 |     |      |
| $E_{off}$    | Turn-off Switching Energy <sup>⑥</sup>             |  | 6.5 |      |     |      |
| $t_{d(on)}$  | Turn-on Delay Time                                 | <b>Inductive Switching (125°C)</b><br>$V_{CC} = 800V$<br>$V_{GE} = 15V$<br>$I_C = 100A$<br>$R_G = 1.0\Omega$<br>$T_J = +125^\circ C$ |     | 44   |     | ns   |
| $t_r$        | Current Rise Time                                  |  |     | 100  |     |      |
| $t_{d(off)}$ | Turn-off Delay Time                                |  |     | 540  |     |      |
| $t_f$        | Current Fall Time                                  |  |     | 125  |     | mJ   |
| $E_{on1}$    | Turn-on Switching Energy <sup>④</sup>              |  |     | 14.6 |     |      |
| $E_{on2}$    | Turn-on Switching Energy (With Diode) <sup>⑤</sup> |  |     | 21.4 |     |      |
| $E_{off}$    | Turn-off Switching Energy <sup>⑥</sup>             |  | 9.2 |      |     |      |

## THERMAL AND MECHANICAL CHARACTERISTICS

| Symbol          | Characteristic   | MIN  | TYP  | MAX  | UNIT  |
|-----------------|--|------|------|------|-------|
| $R_{\theta JC}$ | Junction to Case ( <b>IGBT</b> )   |      |      | 0.20 | °C/W  |
| $R_{\theta JC}$ | Junction to Case ( <b>DIODE</b> )  |      |      | N/A  |       |
| $V_{Isolation}$ | RMS Voltage (50-60Hz Sinusoidal Waveform from Terminals to Mounting Base for 1 Min.) | 2500 |      |      | Volts |
| $W_T$           | Package Weight   |      | 1.03 |      | oz    |
|                 |  |      | 29.2 |      | gm    |
| Torque          | Maximum Terminal & Mounting Torque   |      |      | 10   | lb•in |
|                 |  |      |      | 1.1  | N•m   |

① Repetitive Rating: Pulse width limited by maximum junction temperature.

② For Combi devices,  $I_{ces}$  includes both IGBT and diode leakages

③ See MIL-STD-750 Method 3471.

④  $E_{on1}$  is the clamped inductive turn-on energy of the IGBT only, without the effect of a commutating diode reverse recovery current adding to the IGBT turn-on loss. Tested in inductive switching test circuit shown in figure 21, but with a Silicon Carbide diode.

⑤  $E_{on2}$  is the clamped inductive turn-on energy that includes a commutating diode reverse recovery current in the IGBT turn-on switching loss. (See Figures 21, 22.)

⑥  $E_{off}$  is the clamped inductive turn-off energy measured in accordance with JEDEC standard JESD24-1. (See Figures 21, 23.)

APT Reserves the right to change, without notice, the specifications and information contained herein.

# TYPICAL PERFORMANCE CURVES

APT60GF120JRDQ3

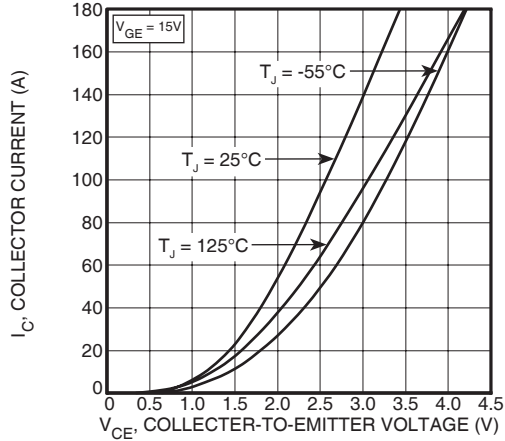

FIGURE 1, Output Characteristics ( $T_J = 25^\circ\text{C}$ )

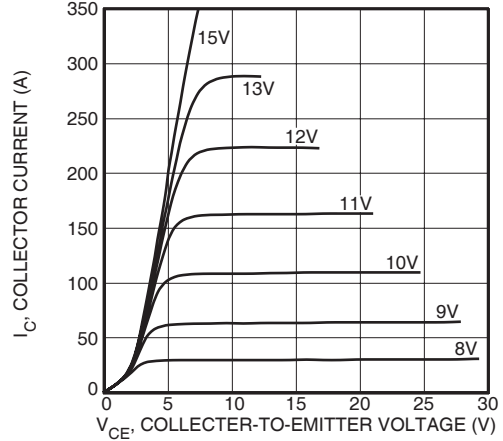

FIGURE 2, Output Characteristics ( $T_J = 125^\circ\text{C}$ )

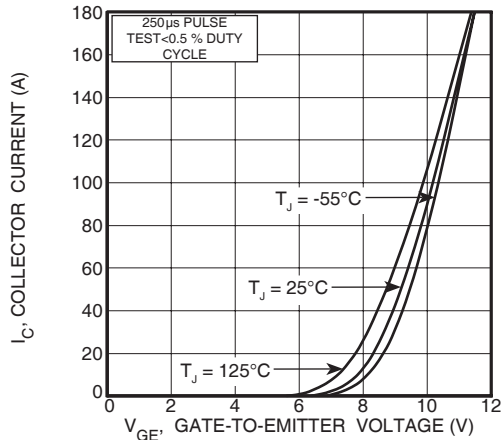

FIGURE 3, Transfer Characteristics

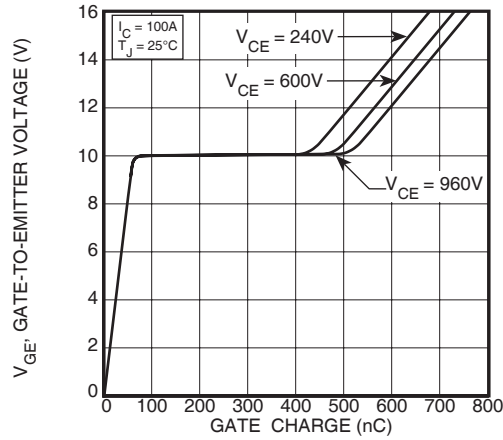

FIGURE 4, Gate Charge

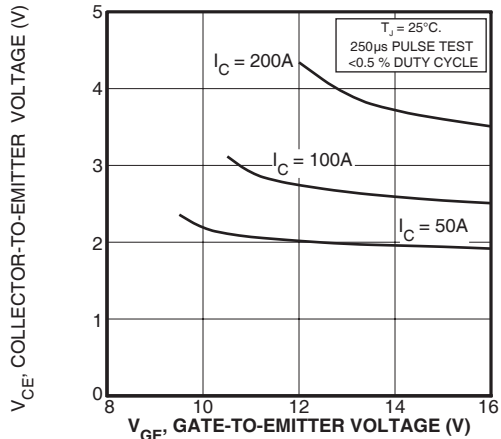

FIGURE 5, On State Voltage vs Gate-to-Emitter Voltage

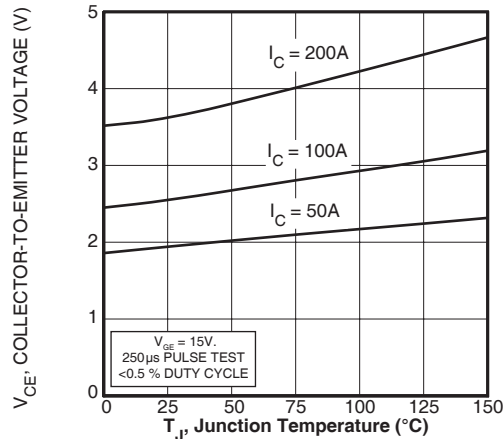

FIGURE 6, On State Voltage vs Junction Temperature

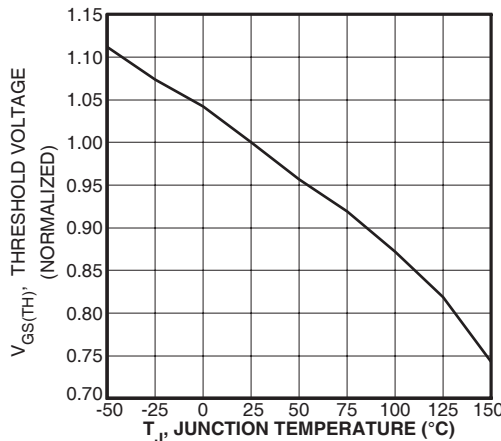

FIGURE 7, Threshold Voltage vs. Junction Temperature

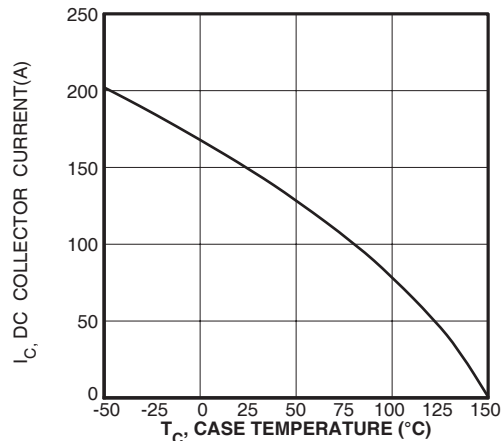

FIGURE 8, DC Collector Current vs Case Temperature

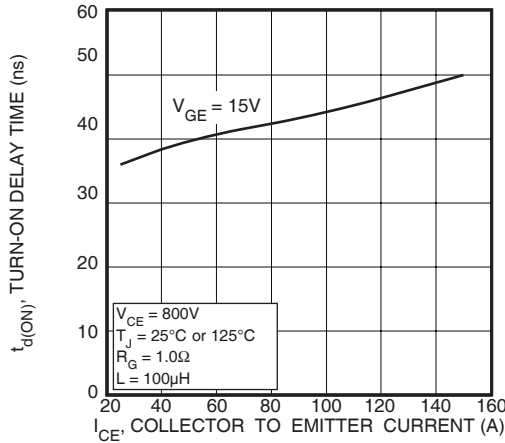

FIGURE 9, Turn-On Delay Time vs Collector Current

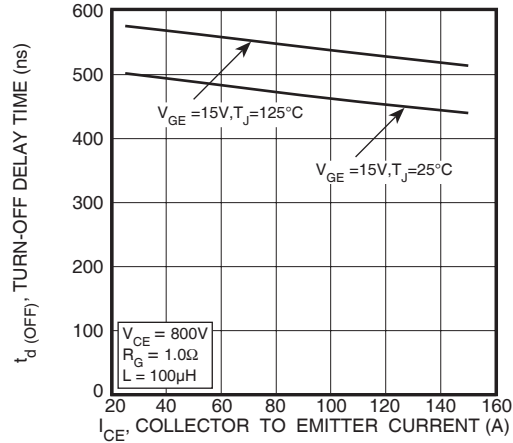

FIGURE 10, Turn-Off Delay Time vs Collector Current

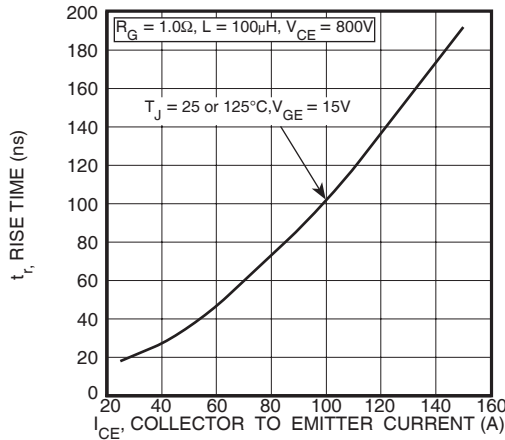

FIGURE 11, Current Rise Time vs Collector Current

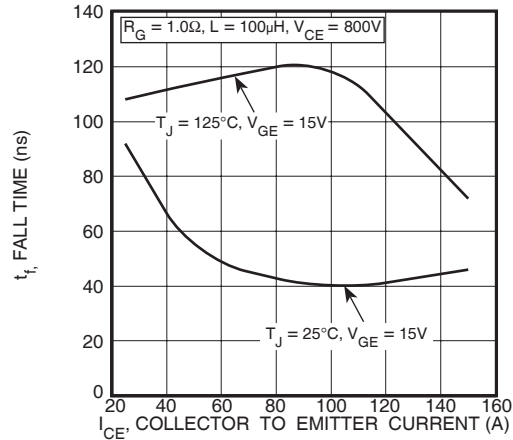

FIGURE 12, Current Fall Time vs Collector Current

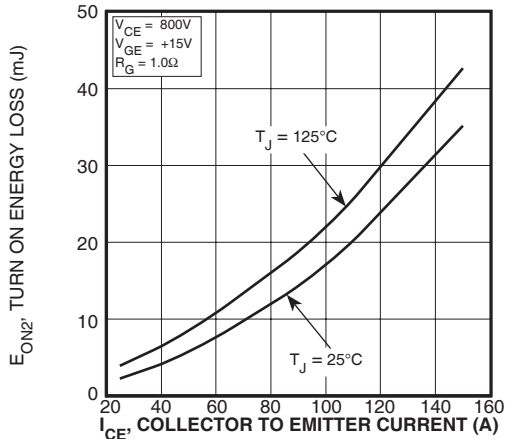

FIGURE 13, Turn-On Energy Loss vs Collector Current

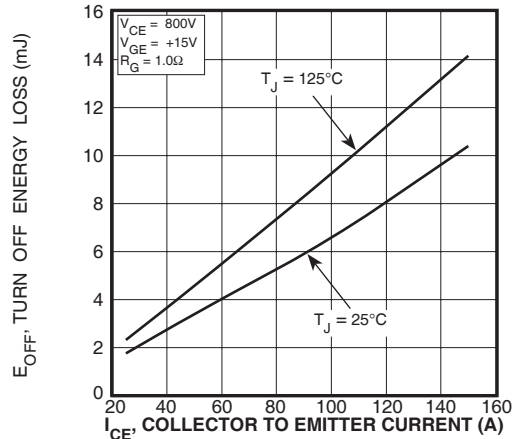

FIGURE 14, Turn Off Energy Loss vs Collector Current

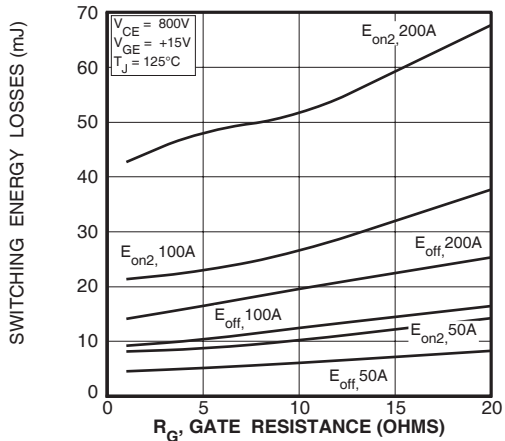

FIGURE 15, Switching Energy Losses vs. Gate Resistance

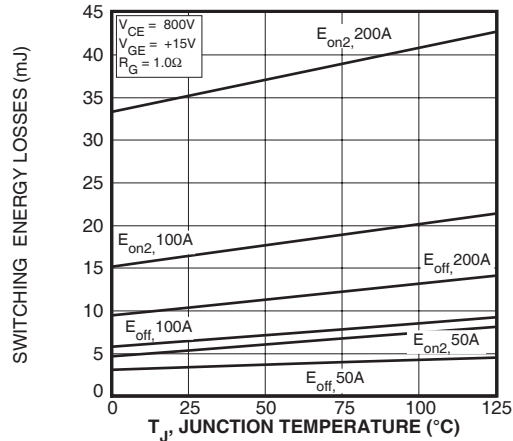

FIGURE 16, Switching Energy Losses vs Junction Temperature

### TYPICAL PERFORMANCE CURVES

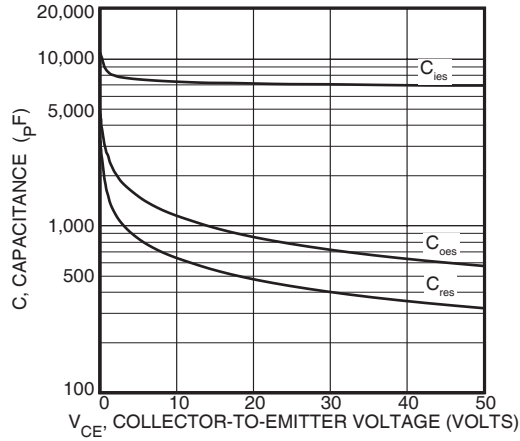

Figure 17, Capacitance vs Collector-To-Emitter Voltage

### APT60GF120JRDQ3

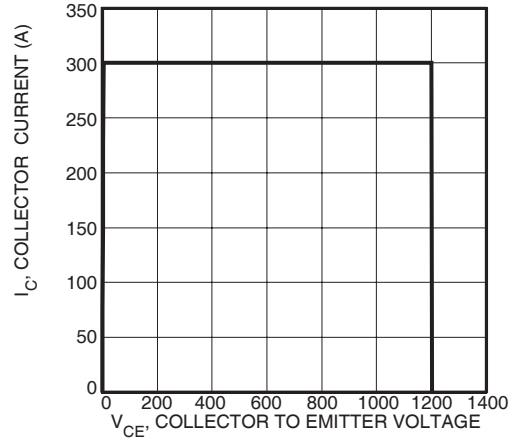

Figure 18, Minimum Switching Safe Operating Area

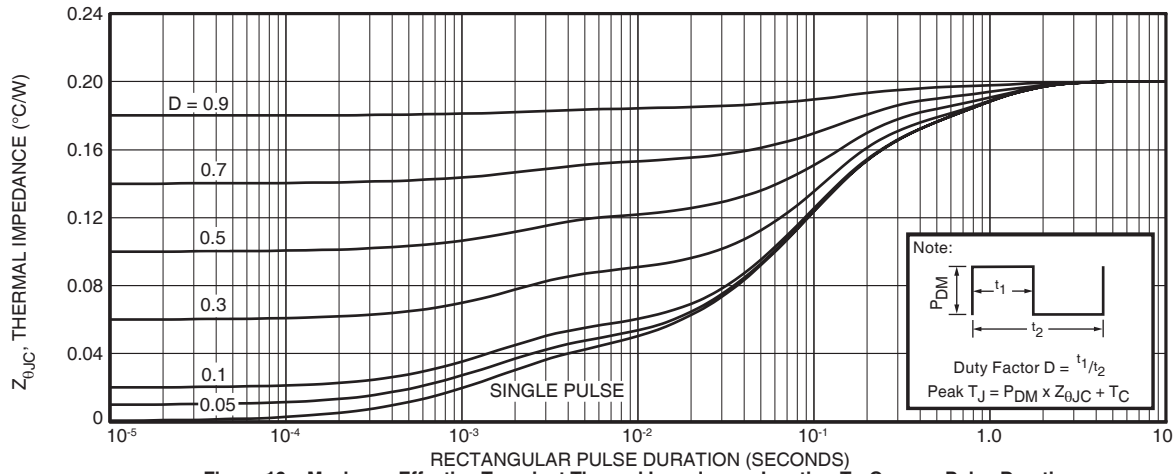

Figure 19a, Maximum Effective Transient Thermal Impedance, Junction-To-Case vs Pulse Duration

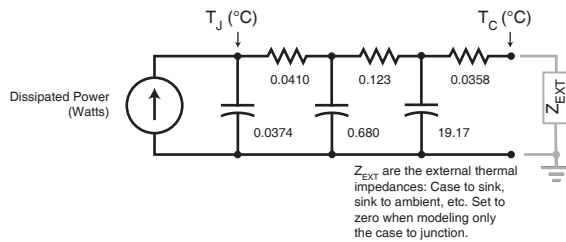

FIGURE 19b, TRANSIENT THERMAL IMPEDANCE MODEL

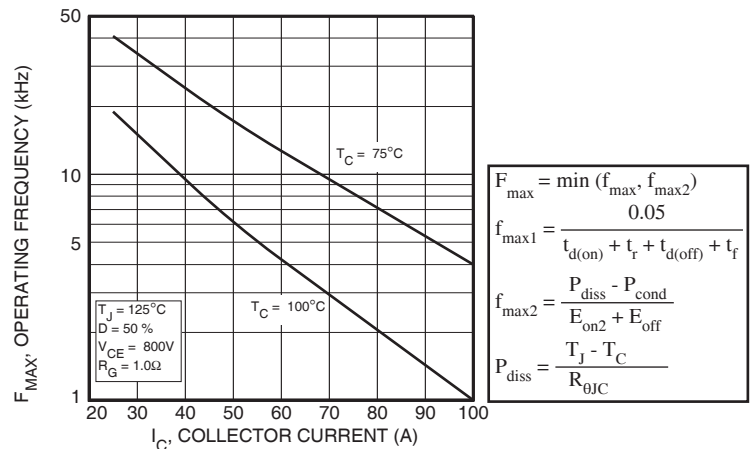

Figure 20, Operating Frequency vs Collector Current

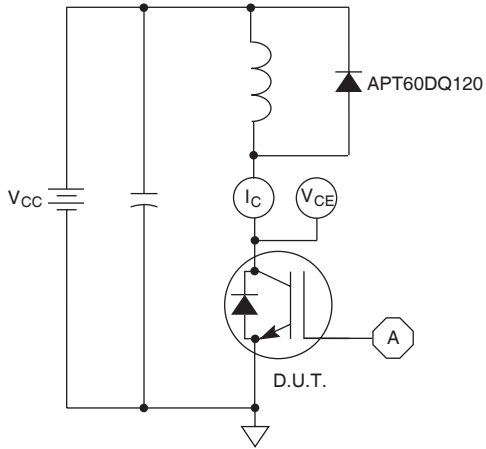

Figure 21, Inductive Switching Test Circuit

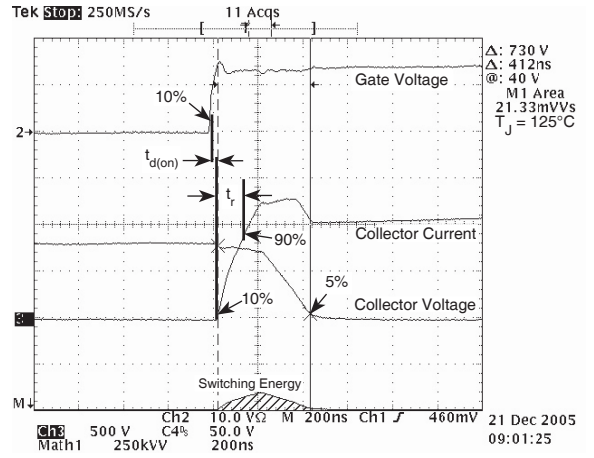

Figure 22, Turn-on Switching Waveforms and Definitions

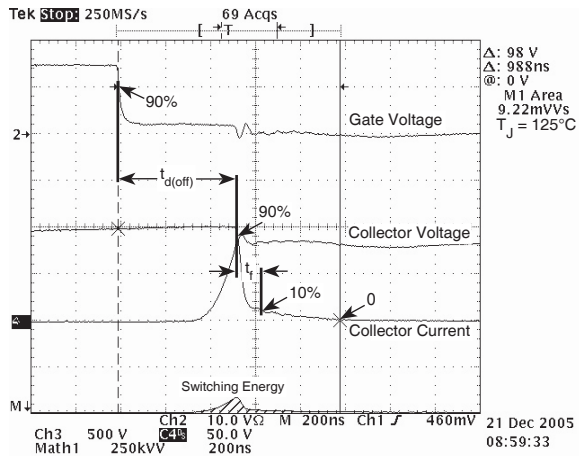

Figure 23, Turn-off Switching Waveforms and Definitions

# ULTRAFAST SOFT RECOVERY ANTI-PARALLEL DIODE

**MAXIMUM RATINGS**

All Ratings:  $T_C = 25^\circ\text{C}$  unless otherwise specified.

| Symbol            | Characteristic / Test Conditions   | APT60GF120JRDQ3 |  | UNIT |
|-------------------|--|-----------------|--|------|
| $I_F(\text{AV})$  | Maximum Average Forward Current ( $T_C = 85^\circ\text{C}$ , Duty Cycle = 0.5) | 60              |  | Amps |
| $I_F(\text{RMS})$ | RMS Forward Current (Square wave, 50% duty)                                    | 73              |  |      |
| $I_{\text{FSM}}$  | Non-Repetitive Forward Surge Current ( $T_J = 45^\circ\text{C}$ , 8.3ms)       | 540             |  |      |

**STATIC ELECTRICAL CHARACTERISTICS**

| Symbol | Characteristic / Test Conditions | MIN | TYP   | MAX  | UNIT  |
|--------|----------------------------------|-----|---|------|-------|
| $V_F$  | Forward Voltage                  |     | $I_F = 60\text{A}$                          | 2.5  | Volts |
|        |                                  |     | $I_F = 120\text{A}$                         | 3.07 |       |
|        |                                  |     | $I_F = 60\text{A}, T_J = 125^\circ\text{C}$ | 1.82 |       |

**DYNAMIC CHARACTERISTICS**

| Symbol    | Characteristic                   | Test Conditions   | MIN | TYP  | MAX | UNIT |
|-----------|----------------------------------|---|-----|------|-----|------|
| $t_{rr}$  | Reverse Recovery Time            | $I_F = 1\text{A}, di_F/dt = -100\text{A}/\mu\text{s}, V_R = 30\text{V}, T_J = 25^\circ\text{C}$     | -   | 60   |     | ns   |
| $t_{rr}$  | Reverse Recovery Time            | $I_F = 60\text{A}, di_F/dt = -200\text{A}/\mu\text{s}, V_R = 800\text{V}, T_C = 25^\circ\text{C}$   | -   | 265  |     |      |
| $Q_{rr}$  | Reverse Recovery Charge          |   | -   | 560  |     | nC   |
| $I_{RRM}$ | Maximum Reverse Recovery Current |   | -   | 5    | -   | Amps |
| $t_{rr}$  | Reverse Recovery Time            | $I_F = 60\text{A}, di_F/dt = -200\text{A}/\mu\text{s}, V_R = 800\text{V}, T_C = 125^\circ\text{C}$  | -   | 350  |     | ns   |
| $Q_{rr}$  | Reverse Recovery Charge          |   | -   | 2890 |     | nC   |
| $I_{RRM}$ | Maximum Reverse Recovery Current |   | -   | 13   | -   | Amps |
| $t_{rr}$  | Reverse Recovery Time            | $I_F = 60\text{A}, di_F/dt = -1000\text{A}/\mu\text{s}, V_R = 800\text{V}, T_C = 125^\circ\text{C}$ | -   | 150  |     | ns   |
| $Q_{rr}$  | Reverse Recovery Charge          |   | -   | 4720 |     | nC   |
| $I_{RRM}$ | Maximum Reverse Recovery Current |   | -   | 40   | -   | Amps |



FIGURE 24a. MAXIMUM EFFECTIVE TRANSIENT THERMAL IMPEDANCE, JUNCTION-TO-CASE vs. PULSE DURATION

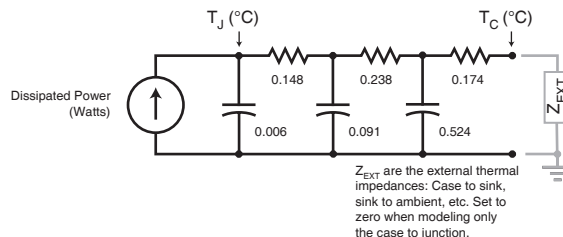

FIGURE 24b. TRANSIENT THERMAL IMPEDANCE MODEL

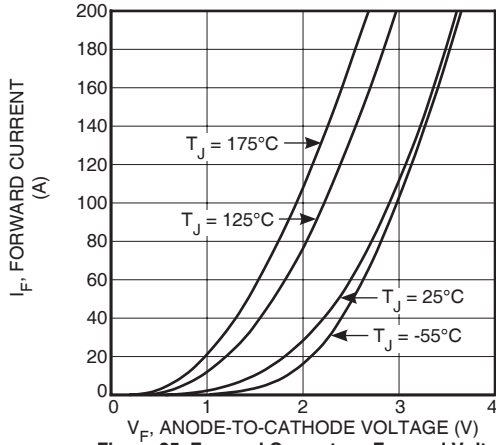

Figure 25. Forward Current vs. Forward Voltage

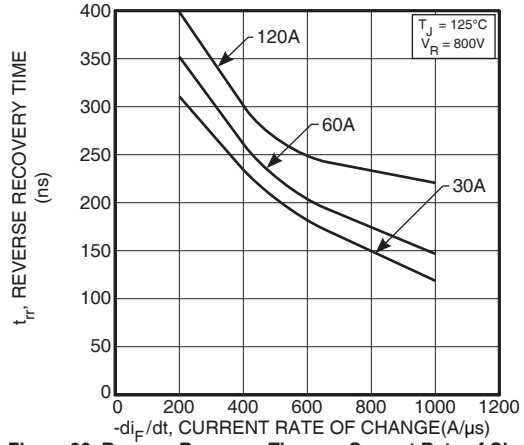

Figure 26. Reverse Recovery Time vs. Current Rate of Change



Figure 27. Reverse Recovery Charge vs. Current Rate of Change



Figure 28. Reverse Recovery Current vs. Current Rate of Change

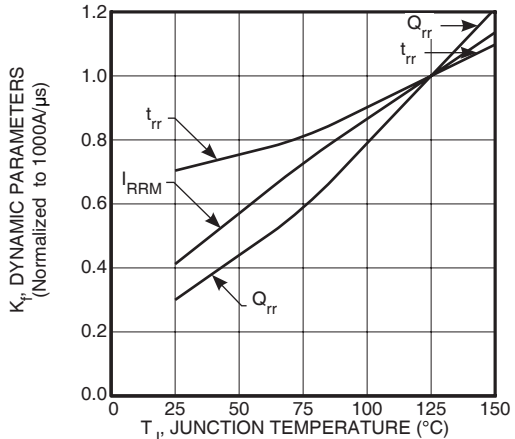

Figure 29. Dynamic Parameters vs. Junction Temperature

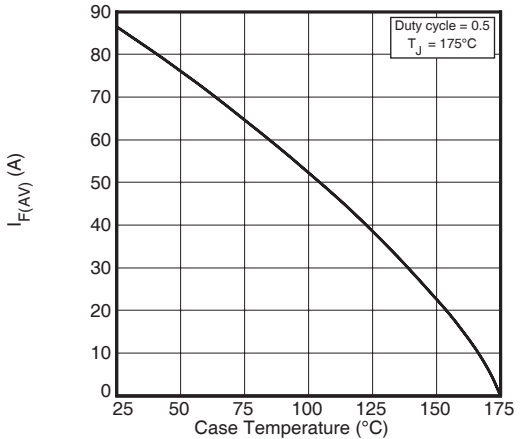

Figure 30. Maximum Average Forward Current vs. Case Temperature

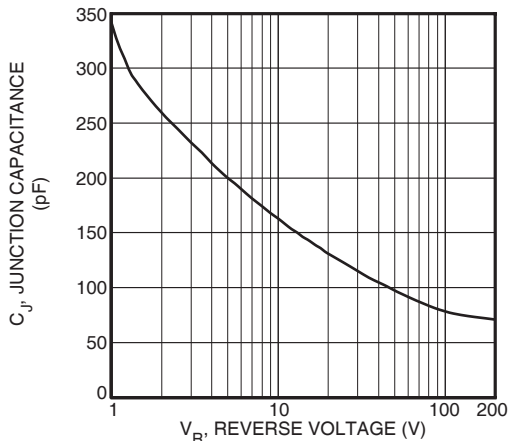

Figure 31. Junction Capacitance vs. Reverse Voltage



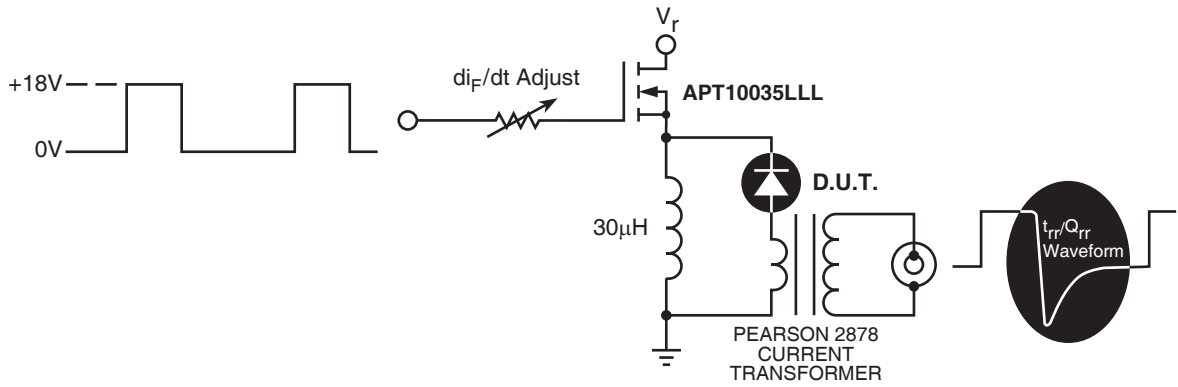

Figure 32. Diode Test Circuit

- 1  $I_F$  - Forward Conduction Current
- 2  $di_F/dt$  - Rate of Diode Current Change Through Zero Crossing.
- 3  $I_{RRM}$  - Maximum Reverse Recovery Current.
- 4  $t_{rr}$  - Reverse Recovery Time, measured from zero crossing where diode current goes from positive to negative, to the point at which the straight line through  $I_{RRM}$  and  $0.25 \cdot I_{RRM}$  passes through zero.
- 5  $Q_{rr}$  - Area Under the Curve Defined by  $I_{RRM}$  and  $t_{rr}$ .

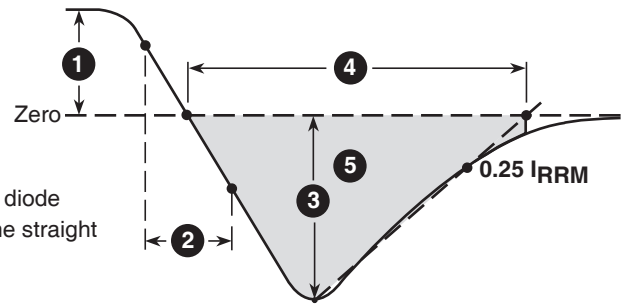
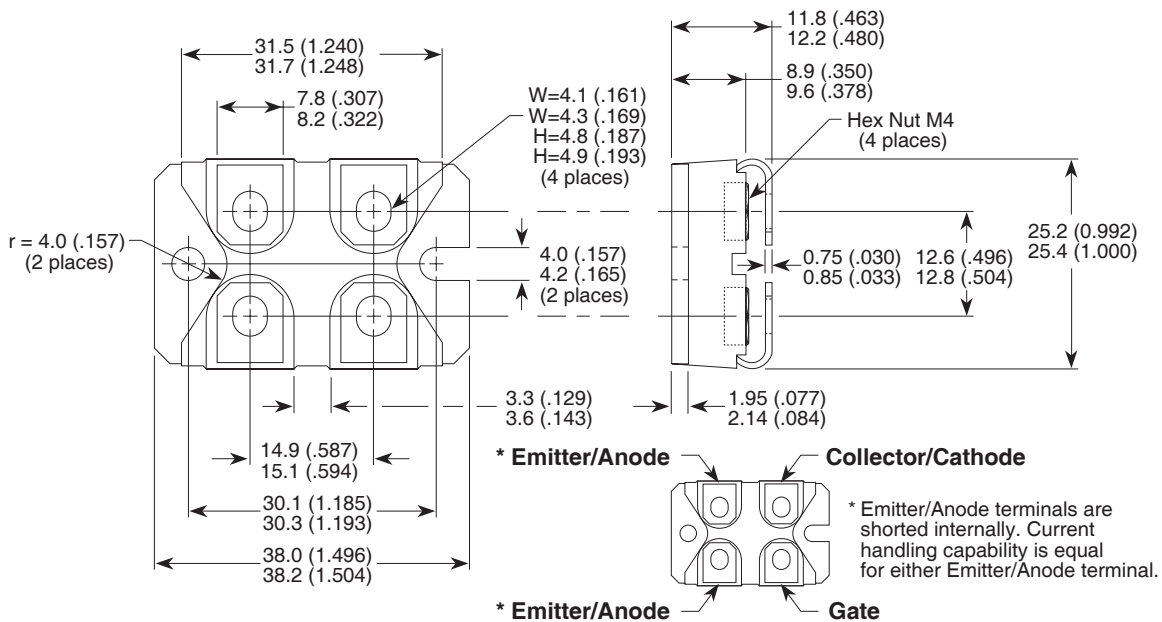

Figure 33. Diode Reverse Recovery Waveform and Definitions

SOT-227 (ISOTOP®) Package Outline



Dimensions in Millimeters and (Inches)