

MMBT2222A-HF (NPN)

RoHS Device
Halogen Free

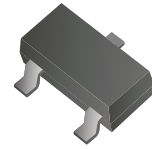

Features

-NPN silicon epitaxial planar transistor for switching and amplifier application.

Mechanical data

- Case: SOT-23, molded plastic.
- Terminals: solderable per MIL-STD-750, method 2026.
- Approx. weight: 0.008 grams

Diagram:

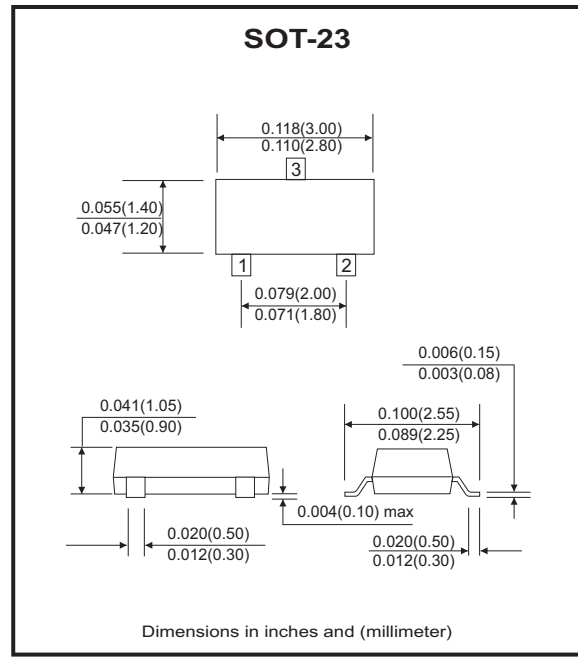
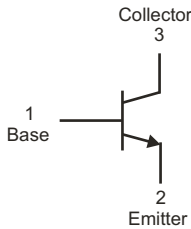

Maximum Ratings (at Ta=25°C unless otherwise noted)

Parameter	Symbol	Value	Units
Collector-Base voltage	V _{CB0}	75	V
Collector-Emitter voltage	V _{CEO}	40	V
Emitter-Base voltage	V _{EBO}	6.0	V
Collector current-continuous	I _c	600	mA
Power dissipation	P _c	300	mW
Thermal resistance, junction to ambient	R _{θJA}	417	°C/W
Junction temperature	T _J	150	°C
Storage temperature range	T _{STG}	-55 to +150	°C

Company reserves the right to improve product design , functions and reliability without notice.

Electrical Characteristics (@TA=25°C unless otherwise noted)

Parameter	Symbol	Conditions	Min.	Max.	Units
Collector-Base breakdown voltage	$V_{(BR)CBO}$	$I_C=10\mu A, I_E=0$	75		V
Collector-Emitter breakdown voltage	$V_{(BR)CEO}$	$I_C=10mA, I_B=0$	40		V
Emitter-Base breakdown voltage	$V_{(BR)EBO}$	$I_E=10\mu A, I_C=0$	6		V
Collector cut-off current	I_{CBO}	$V_{CB}=60V, I_E=0$		0.01	μA
Collector cut-off current	I_{CEO}	$V_{CE}=30V, V_{BE(off)}=3V$		0.01	μA
Emitter cut-off current	I_{EBO}	$V_{EB}=3V, I_C=0$		0.1	μA
DC current gain	$h_{FE(1)}$	$V_{CE}=10V, I_C=150mA$	100	300	
	$h_{FE(2)}$	$V_{CE}=10V, I_C=0.1mA$	40		
	$h_{FE(3)}$	$V_{CE}=10V, I_C=500mA$	42		
Collector-Emitter saturation voltage	$V_{CE(sat)}$	$I_C=150mA, I_B=15mA$ $I_C=500mA, I_B=50mA$		0.3 1	V
Base-Emitter saturation voltage	$V_{BE(sat)}$	$I_C=150mA, I_B=15mA$ $I_C=500mA, I_B=50mA$		1.2 2.0	V
Transition frequency	f_T	$V_{CE}=20V, I_C=20mA$ $f=100MHz$	300		MHz
Delay time (see fig.1)	t_d	$V_{CC}=30V, V_{BE(off)}=-0.5V$ $I_C=150mA, I_{B1}=15mA$		10	nS
Rise time (see fig.1)	t_r			25	nS
Storage time (see fig.2)	t_s	$V_{CC}=30V, I_C=150mA$ $I_{B1}=-I_{B2}=15mA$		225	nS
Fall time (see fig.2)	t_f			60	nS

Notes:

1. Pulse test: Pulse Width $\leq 300\mu s$, Duty Cycle $\leq 2.0\%$.

Company reserves the right to improve product design , functions and reliability without notice.

RATING AND CHARACTERISTIC CURVES (MMBT2222A-HF)

Fig.1 - Static Characteristic

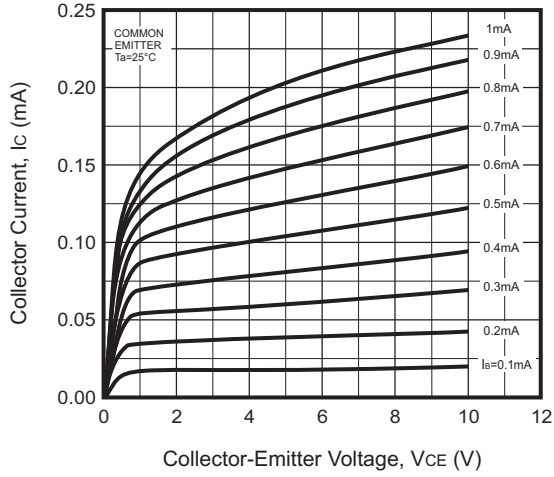

Fig.2 - $h_{FE} - I_c$

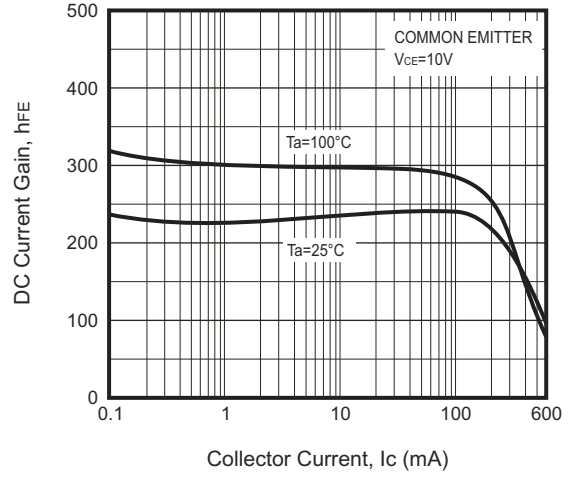

Fig.3 - $V_{CEsat} - I_c$

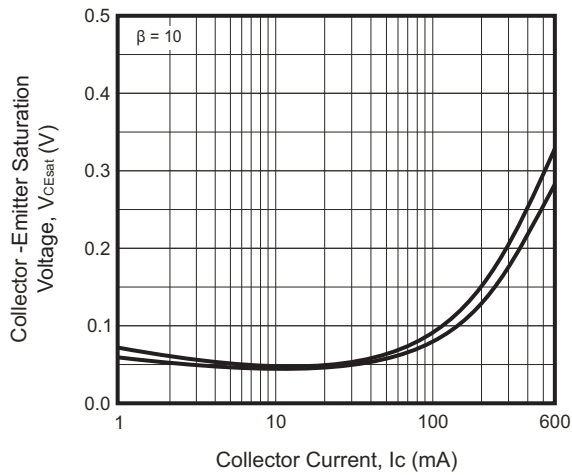

Fig.4 - $V_{BEsat} - I_c$

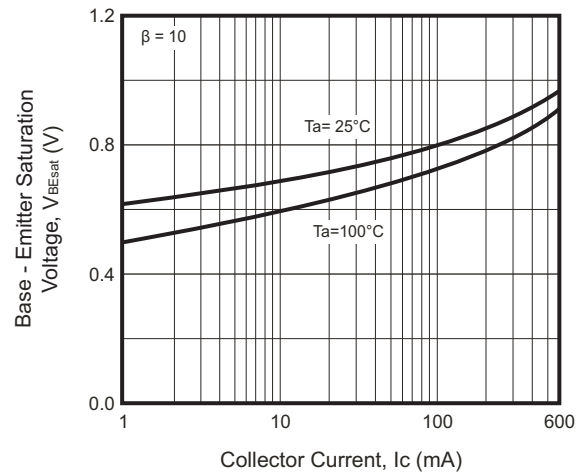

Fig.5 - $I_c - V_{BE}$

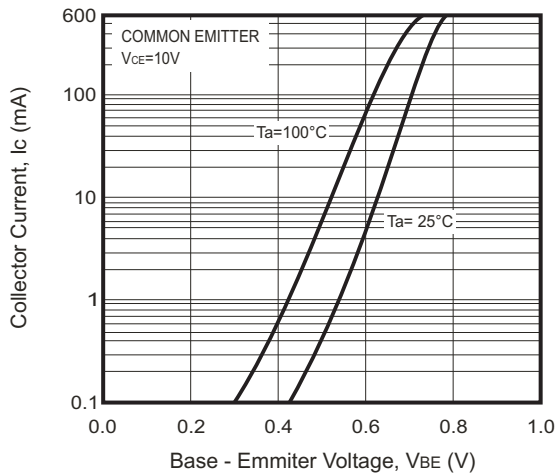
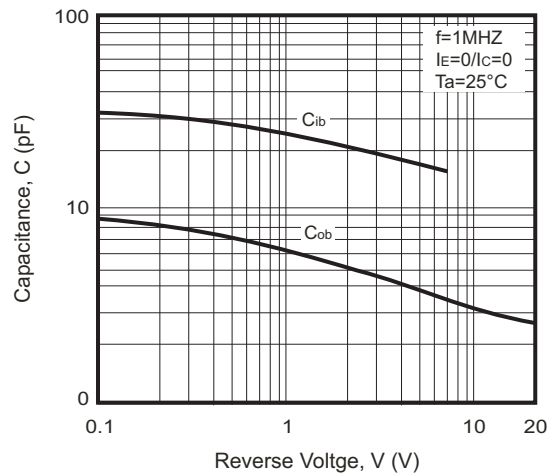

Fig.7 - $C_{ob}/C_{ib} - V_{CB}/V_{EB}$



RATING AND CHARACTERISTIC CURVES (MMBT222A-HF)

Fig.7 - F_T — I_c

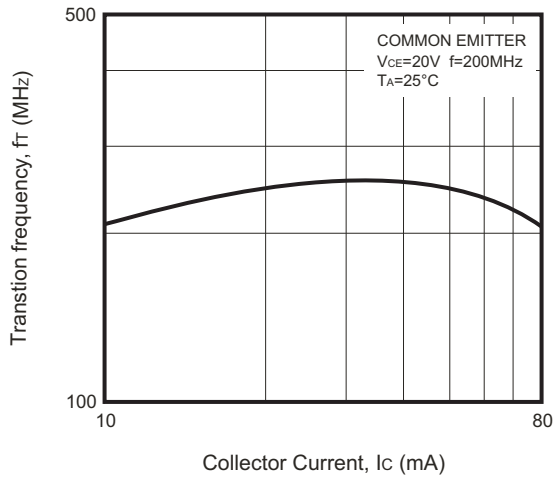
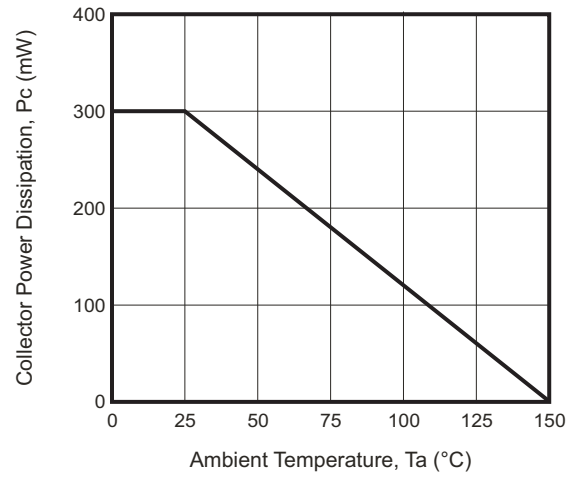
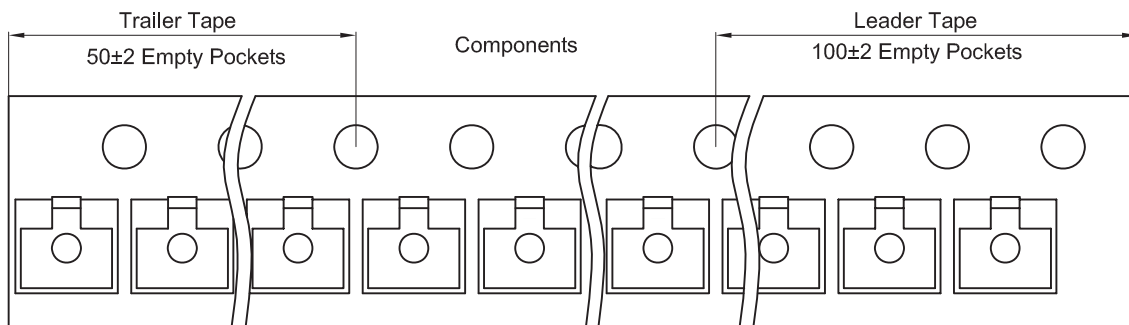
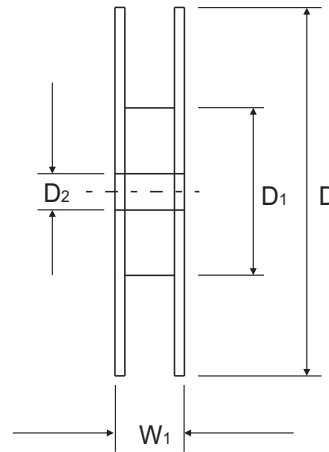
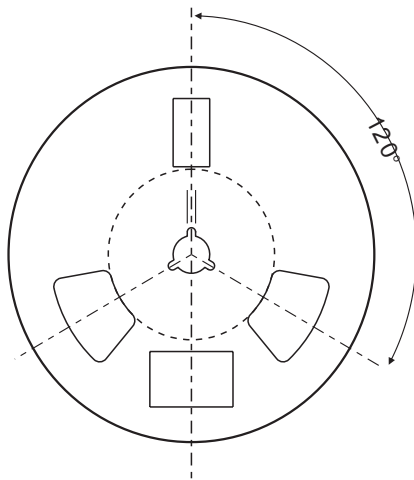
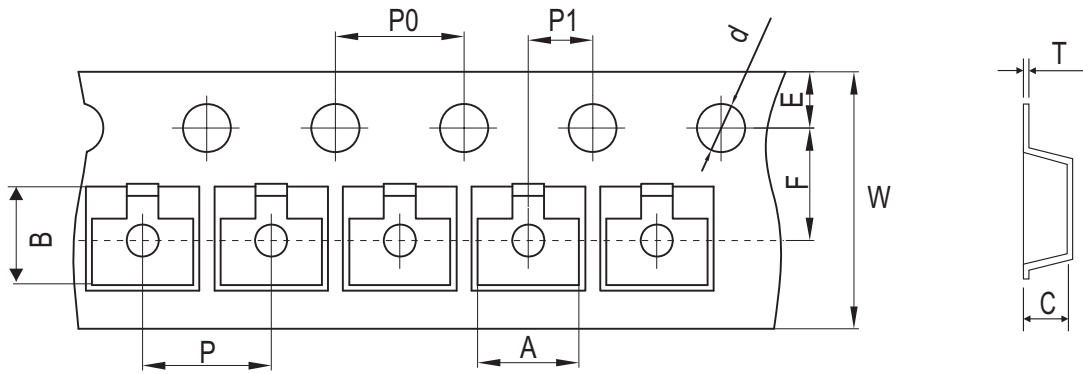

Fig.8 - P_c — T_a



Reel Taping Specification



SOT-23	SYMBOL	A	B	C	d	D	D1	D2
	(mm)	3.15 ± 0.10	2.77 ± 0.10	1.22 ± 0.10	Φ1.50 ± 0.10	178 ± 2.00	54.40 ± 1.00	13.00 ± 1.00
	(inch)	0.124 ± 0.004	0.109 ± 0.004	0.048 ± 0.004	Φ0.059 ± 0.004	7.008 ± 0.079	2.142 ± 0.039	0.512 ± 0.039

SOT-23	SYMBOL	E	F	P	P0	P1	W	W1
	(mm)	1.75 ± 0.10	3.50 ± 0.10	4.00 ± 0.10	4.00 ± 0.10	2.00 ± 0.10	8.00 + 0.30 / - 0.10	12.30 ± 1.00
	(inch)	0.069 ± 0.004	0.138 ± 0.004	0.157 ± 0.004	0.157 ± 0.004	0.079 ± 0.004	0.315 + 0.012 / - 0.004	0.484 ± 0.039

Marking Code

Part Number	Marking Code
MMBT2222A-HF	1P

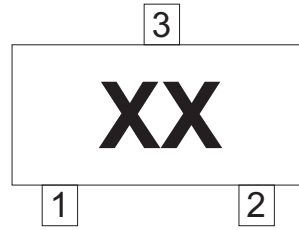

xx = Product type marking code

Suggested PAD Layout

SIZE	SOT-23	
	(mm)	(inch)
A	0.80	0.031
B	1.90	0.075
C	2.02	0.080
D	2.82	0.111

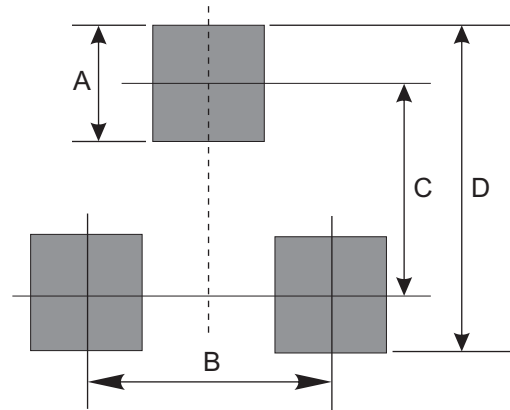

Standard Packaging

Case Type	REEL PACK	
	REEL (pcs)	Reel Size (inch)
SOT-23	3,000	7