

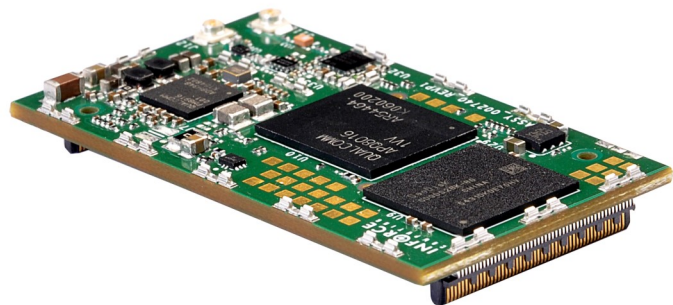









Inforce 6301™

The Micro SOM with extended temperature for industrial and IoT applications



-  Qualcomm® Snapdragon™ 410E Quad Core CPU (APQ8016E SoC)
-  Qualcomm® Adreno™ 306 GPU
-  Qualcomm® Hexagon™ DSP @700MHz
-  Easy Product Upgrades with Interchangeable SOMs
-  Extended Temperature for Industrial Applications -30°C to 85°C
-  Enterprise online support with Inforce TechWeb
-  Support for Android and Linux OS



Inforce 6301: The Micro SOM for Industrial and Internet of Things Applications

Based on the Snapdragon 410E SoC, the Inforce 6301 Micro SOM is a low cost solution designed to be at the heart of intelligent devices and gateways at the edge of the Internet of Things. With the superior edge processing, extended temperature grade, and the ability to deploy at scale, the Inforce 6301 is the ideal platform for IoT specifically for asset tracking, automation and controls, telematics, digital signage, drones, and robotics.

With a low-power 64-bit, quad-core CPU with DSP and powerful GPU, capable of 1080p encode/decode, and built-in Wi-Fi/BT connectivity, you will not need to compromise on performance when IoT applications.



Surveillance



Automation and Controls



Digital Signage



Telematics

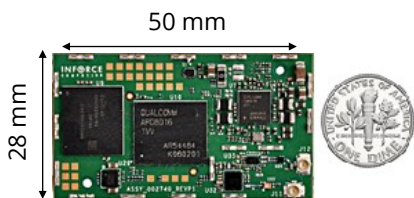

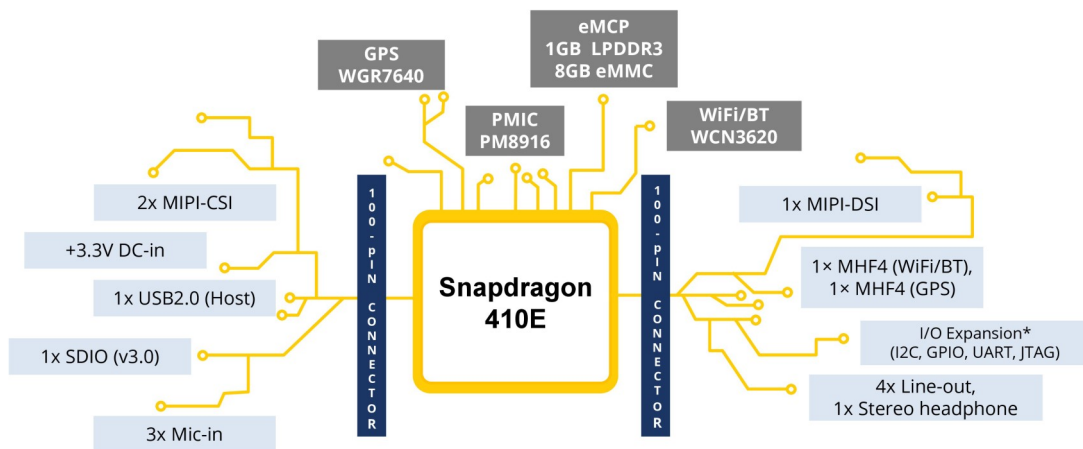

* Not all interfaces can be used at the same time

Technical Specifications

Processor

Qualcomm® Snapdragon™ 410 Quad Core (APQ8016)
 ARM® Cortex® A53, 64-bit CPU @1.2GHz each
 Qualcomm® Adreno™ 306 GPU
 Qualcomm® Hexagon™ DSP @700MHz

Memory/ Storage

1GB LPDDR3@ 533MHz
 8GB eMMC v4.5 (support up to 64GB) NAND flash
 1x µSD card interface with support up to HS200

Connectivity

Bluetooth 4.0 LE
 Wi-Fi Dual stream 802.11 b/g/n/ 2.4GHz

GPS

On-board GPS/GNSS

Multimedia

4-lane MIPI-DSI interface
 H.264 playback and capture @1080p, H.265 playback @1080p
 Hi-Fi Audio with 24bit/192Khz playback support

Camera

Up to a 13MP Camera on MIPI-CSI

Operating System

Choice of pre-loaded Android Lollipop / Ubuntu/
 Debian Linux board support packages (BSP)

Power, Mechanical, and Environmental

Power: +3.3V/5A Input
 Operating Temp: -30 to 85 Degrees
 Relative Humidity: 5 to 95%non-condensing
 RoHS and WEEE compliant

Ordering Info

Part Number	Description	Available
IFC6301-00-P2	Micro SoM (Android)	Now
IFC6301-10-P2	Micro SoM (Linux)	Now
SYS6301-00-P1	Micro SoM based Dev. Kit (Android)	Now
SYS6301-10-P1	Micro SoM based Dev. Kit (Linux)	Now

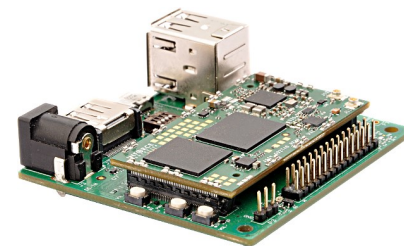

Inforce — Embedded. Connected. Aware.

Inforce Computing® is a supplier of application-ready embedded hardware platforms in eco-aware, low-profile footprints, available off-the-shelf to serve growing markets enabled by the next generation of connected devices. At Inforce, we are inspired by the inflection point in mobile and wireless technologies which is spawning innovative devices, content, and services. Together with silicon, software, and system partners, Inforce is pioneering products with an optimized delivery model for medical imaging, smart office, hands-free computing, and robotics.



Global Sales & Support Inforce Computing Inc. 48820 Kato Road Ste 600B, Fremont, CA 94538 USA
 Phone: (510) 683-9999 | sales@inforcecomputing.com
<http://www.inforcecomputing.com>