

## Features

- For WCDMA Applications
- Usable Bandwidth of 19.2 MHz
- Low Loss
- High Attenuation
- Balanced Operation
- Ceramic Surface Mount Package (SMP)
- Hermetic
- RoHS compliant (2002/95/EC), Pb-free 

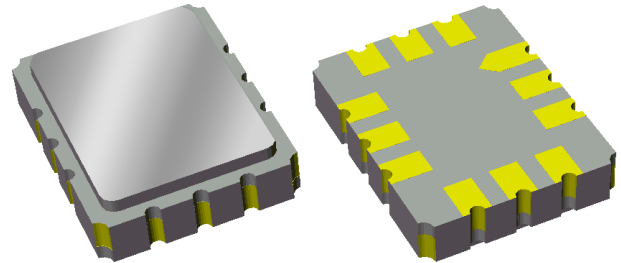

## Package

Surface Mount 7.01 x 5.51 x 1.63 mm  
SMP-28B

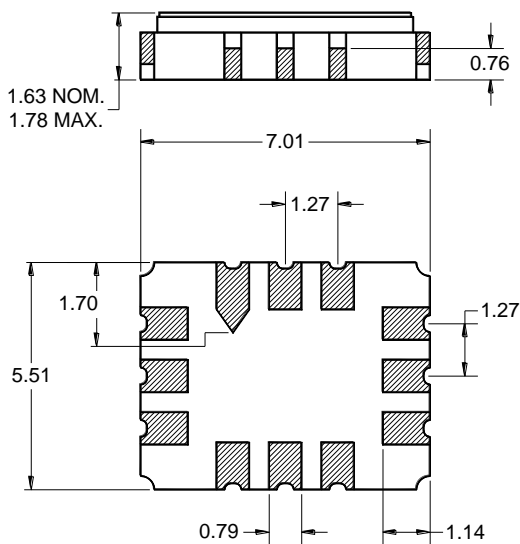

Dimensions shown are nominal in millimeters  
All tolerances are  $\pm 0.15$ mm except overall  
length and width  $\pm 0.13$ mm

Body:  $Al_2O_3$  ceramic  
Lid: Kovar, Ni plated  
Terminations: Au plating 0.5 - 1.0 $\mu$ m,  
over a 2 - 6 $\mu$ m Ni plating

## Pin Configuration

Bottom View

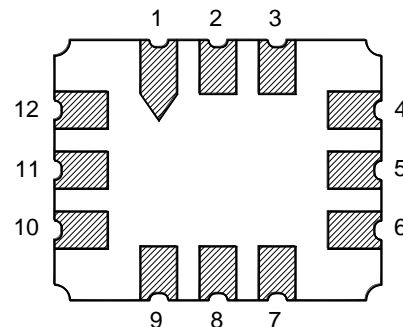

Pin No.	Description
10	Input +
12	Input -
4	Output +
6	Output -
1,2,3,5	Case Ground
7,8,9,11	Case Ground

**Electrical Specifications <sup>(1)</sup>**

Operating Temperature Range: <sup>(2)</sup> -33 to +85 °C

Parameter <sup>(3)</sup>	Minimum	Typical <sup>(4)</sup>	Maximum	Unit
<b>Center Frequency</b>	-	358.4	-	MHz
<b>Insertion Loss at Center Frequency</b>	-	10.1	12.5	dB
<b>Lower 5 dB Bandedge <sup>(5)</sup></b>	343.4	344.8	-	MHz
<b>Upper 5 dB Bandedge <sup>(5)</sup></b>	-	371.8	373.4	MHz
<b>Amplitude Variation</b> 348.8 – 368 MHz	-	0.3	1.0	dB p-p
<b>Absolute Group Delay</b>	-	470	600	ns
<b>Group Delay Variation</b> 348.8 – 368 MHz	-	25	60	ns p-p
<b>Absolute Attenuation <sup>(5)</sup></b>				
10.00 – 286.40 MHz	55	70	-	dB
286.40 – 307.40 MHz	55	62	-	dB
307.40 – 327.70 MHz	40	52	-	dB
327.70 – 335.40 MHz	30	51	-	dB
335.40 – 341.15 MHz	25	38	-	dB
341.15 – 341.65 MHz	20	31	-	dB
341.65 – 342.15 MHz	15	25	-	dB
342.15 – 342.90 MHz	10	17	-	dB
373.90 – 374.65 MHz	10	17	-	dB
374.65 – 375.15 MHz	15	25	-	dB
375.15 – 375.40 MHz	20	32	-	dB
375.40 – 381.40 MHz	25	37	-	dB
381.40 – 389.10 MHz	30	49	-	dB
389.10 – 409.40 MHz	40	51	-	dB
409.40 – 430.40 MHz	55	64	-	dB
430.40 – 640.00 MHz	55	66	-	dB
640.00 – 720.00 MHz	50	55	-	dB
720.00 – 1000 MHz	55	70	-	dB
<b>Time Side-lobe Response Attenuation (1.0 – 500 μs)</b>	40	48	-	dB
<b>Source Impedance Balanced <sup>(6)</sup></b>	-	200	-	Ω
<b>Load Impedance Balanced <sup>(6)</sup></b>	-	200	-	Ω

**Notes:**

1. All specifications are based on the TriQuint test circuit shown on page 4
2. In production, devices will be tested at room temperature to a guardbanded specification to ensure electrical compliance over temperature
3. Electrical margin has been built into the design to account for the variations due to temperature drift and manufacturing tolerances
4. Typical values are based on average measurements at room temperature
5. Relative to insertion loss at center frequency
6. This is the optimum impedance in order to achieve the performance shown

**Typical Performance (at room temperature)**

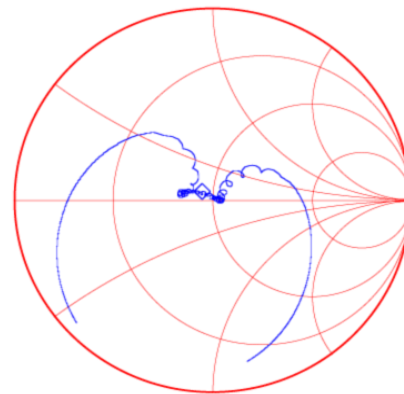
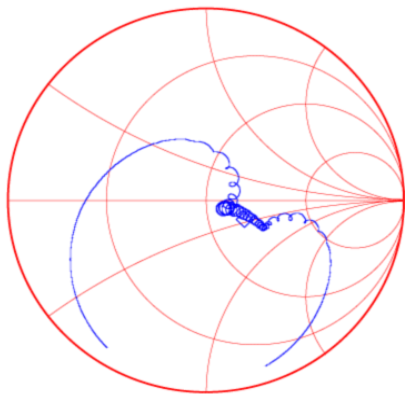
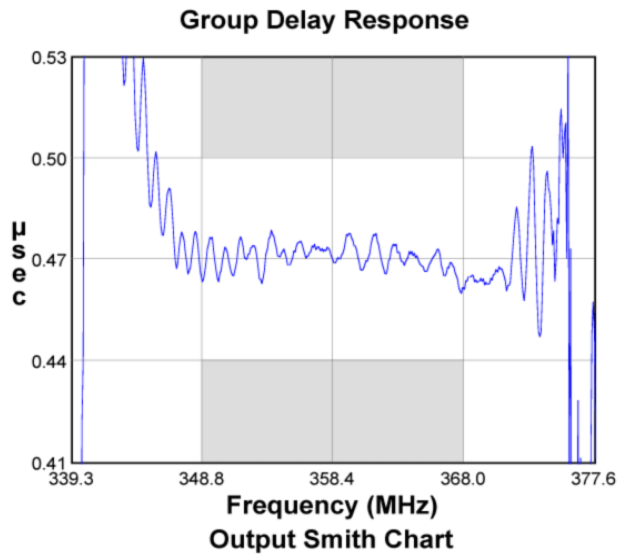
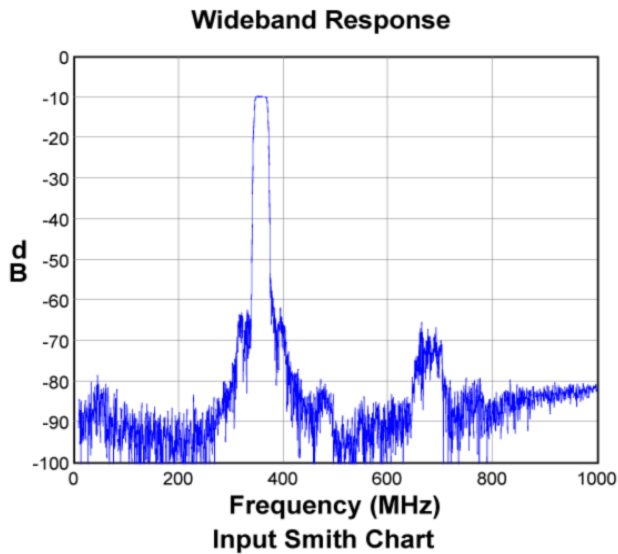
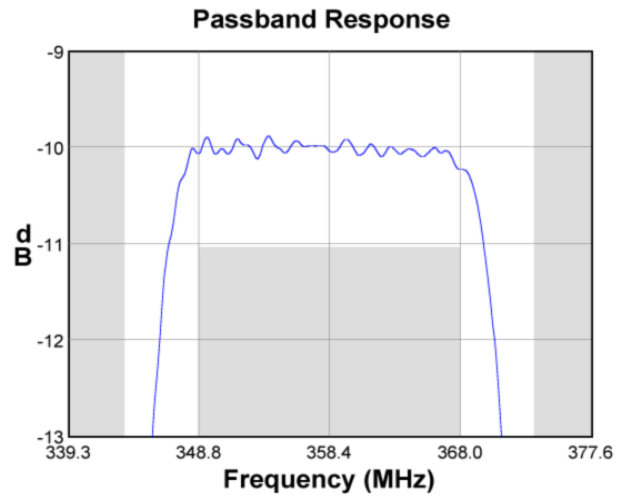
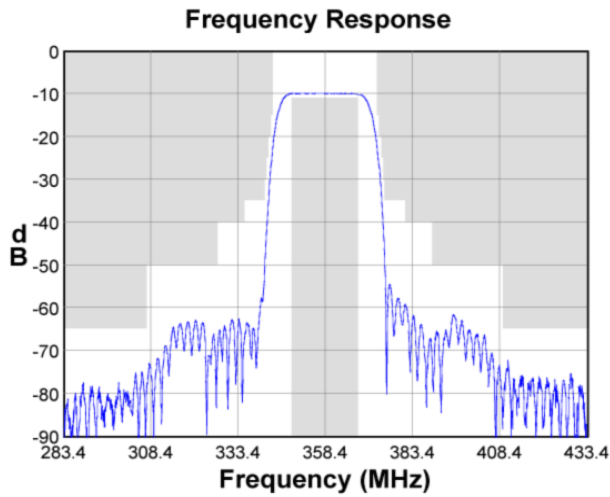

**Matching Schematics**

Actual matching values may vary due to PCB layout and parasitics

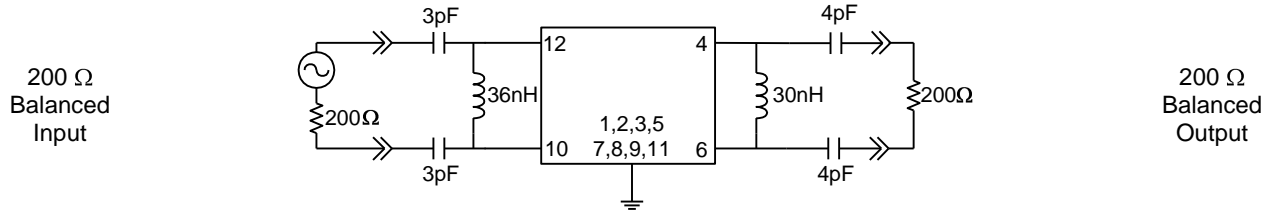

**Marking**

**PCB Footprint**

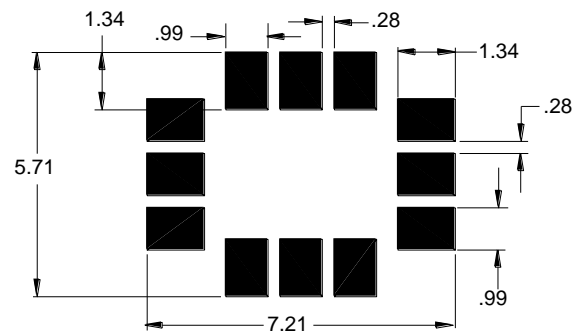
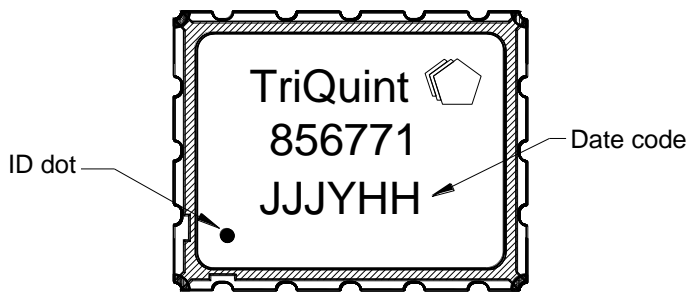

The date code consists of: day of the current year (Julian, 3 digits), Y=last digit of the year (1 digit) and H=military hour (2 digits)

This footprint represents a recommendation only  
Dimensions shown are nominal in millimeters

**Tape and Reel**

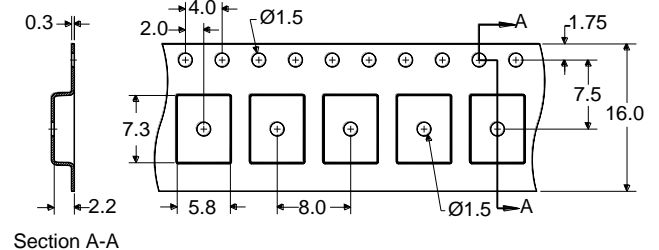
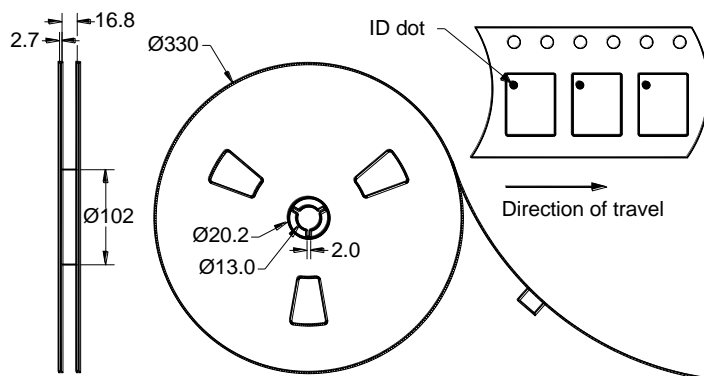

Dimensions shown are nominal in millimeters  
Packaging quantity: 3000 units/reel

### Maximum Ratings

Parameter	Symbol	Minimum	Maximum	Unit
Operating Temperature Range	T	-33	+85	°C
Storage Temperature Range	T <sub>stg</sub>	-40	+85	°C
Input Power (at +50°C for 24 hours max)	P <sub>in</sub>	-	+19	dBm

### Important Notes

#### Warnings

- Electrostatic Sensitive Device (ESD) 
- Avoid ultrasonic exposure

#### RoHS Compliance

- This product complies with EU directive 2002/95/EC (RoHS) 

#### Solderability

- Compatible with JESD22-B102, Pb-free process, 260C peak reflow temperature ([see soldering profile](#))

### Links to Additional Technical Information

[PCB Layout Tips](#)

[Qualification Flowchart](#)

[Soldering Profile](#)

[S-Parameters](#)

[RoHS Information](#)

[Other Technical Information](#)

TriQuint's liability is limited only to the Surface Acoustic Wave (SAW) component(s) described in this data sheet. TriQuint does not accept any liability for applications, processes, circuits or assemblies, which are implemented using any TriQuint component described in this data sheet.

### Contact Information

**TriQuint**   
SEMICONDUCTOR

PO Box 609501  
Orlando, FL 32860-9501  
USA

Phone: +1 (407) 886-8860  
Fax: +1 (407) 886-7061  
Email: [info-product@tqs.com](mailto:info-product@tqs.com)  
Web: [www.triquint.com](http://www.triquint.com)

Or contact one of our worldwide  
Network of [sales offices](#),  
[Representatives or distributors](#)