

RTY Series

Hall-Effect Rotary Position Sensors



DESCRIPTION

The RTY Series Hall-Effect Rotary Position Sensors provide angle monitoring in harsh transportation and industrial applications at a competitive cost.

These products use a magnetically biased, Hall-effect integrated circuit (IC) to sense rotary movement of the actuator shaft over a set operating range. Rotation of the actuator shaft changes a magnet's position relative to the IC. The resulting flux density change is converted to a linear output.

The IC, together with conditioning and protection circuitry, and the permanent magnet, is sealed in an IP67-qualified rugged package for durability in most harsh environments.

FEATURES AND BENEFITS (★=competitive differentiator)

- ★ **35 M cycle product life:** Provides long life in the application
- **Solid-state Hall-effect technology:** Provides non-contact operation, long service life, low torque actuation and reduces worn-out mechanisms
- **Rugged IP67-sealed package with integral connector:** Allows for use in harsh environments
- **Automotive-grade EMI/EMC testing, integrated reverse polarity, and short circuit:** Provides protection against installation errors and frequencies in the environment
- **Industry-standard AMP termination, 32 mm mounting pitch, North American and European pinout styles, and compact package:** Provide drop-in replacement
- **Eight operating ranges up to 360°:** Provides flexibility in multiple applications, allowing OEMs the range of travel needed for the application

Eight operating ranges (50°, 60°, 70°, 90°, 120°, 180°, 270° and 360°) are tolerant to over-travel and allow use in most common applications. Low voltage and high voltage versions cover an input voltage range of 4.5 Vdc to 30 Vdc.

Most applications require no lever, and no brackets are necessary.

Honeywell's industry-leading capabilities in research and development provide the customer with known quality and support.

POTENTIAL APPLICATIONS

Transportation:

- Position and movement detection of pedals, throttles, gear shift, levers, steering, linkages, and hitches (trucks, buses, off-road vehicles, industrial/construction/agricultural vehicles and equipment, cranes)
- Suspension displacement/kneeling (buses, trucks)
- Tilt/trim position (boat engines, tilling equipment)

Industrial:

- Valve control
- HVAC damper control
- Irrigation pivot control

RTY Series

Table 1. Specifications

| Characteristic | Parameter | |
|--|--|--|
| | LV (Low Voltage) | HV (High Voltage) |
| Supply voltage | 5 ±0.5 Vdc | 10 Vdc to 30 Vdc |
| Supply current | 20 mA max. | 32 mA max. |
| Supply current (during output to ground short) | 25 mA max. | 47 mA max. |
| Output | 0.5 V to 4.5 V ratiometric | 0.5 V to 4.5 V non-ratiometric |
| Output signal delay | 4 ms typ. | |
| Overvoltage protection | 10 Vdc | – |
| Reverse polarity protection | -10 Vdc | -30 Vdc |
| Output to ground short circuit protection | continuous | |
| Output load resistance (pull down to ground) | 10 kOhm | |
| EMI: | 100 V/m from 200 MHz to 1000 MHz per ISO11452-2 | |
| radiated immunity | 100 mA BCI per ISO11452-4 | |
| conducted immunity | from 1 MHz to 200 MHz | 100 mA BCI per ISO11452-4 from 1 MHz to 400 MHz |
| EMC | exceeds CE requirements | |
| Operating temperature range | -40 °C to 125 °C [-40 °F to 257 °F] | |
| Storage temperature range | -40 °C to 125 °C [-40 °F to 257 °F] | |
| Ingress protection | IP67 according to DIN 40050 | |
| Expected life | 35 M cycles | |
| Media compatibility | heavy transportation fluids | |
| Housing material | PBT plastic | |
| Shock | 50 G peak | |
| Vibration | 20 G peak tested from 10 Hz to 2000 Hz | |
| Salt fog | concentration 5% ±1% for 240 hr per SAE M1455 Section 4.3.3.1 (at 5.0 Vdc. 38 °C [100 F °]) | |
| Resolution | 12 bit | |
| Mating connector | AMP Superseal 282087-1 | |
| Mechanical end stop | no | |
| Approvals | CE | |

Hall-Effect Rotary Position Sensors

Figure 1. Mounting Dimensions (For Reference Only: mm/[in.])



Figure 2. Functional Characteristics



Figure 3. Nomenclature and Order Guide

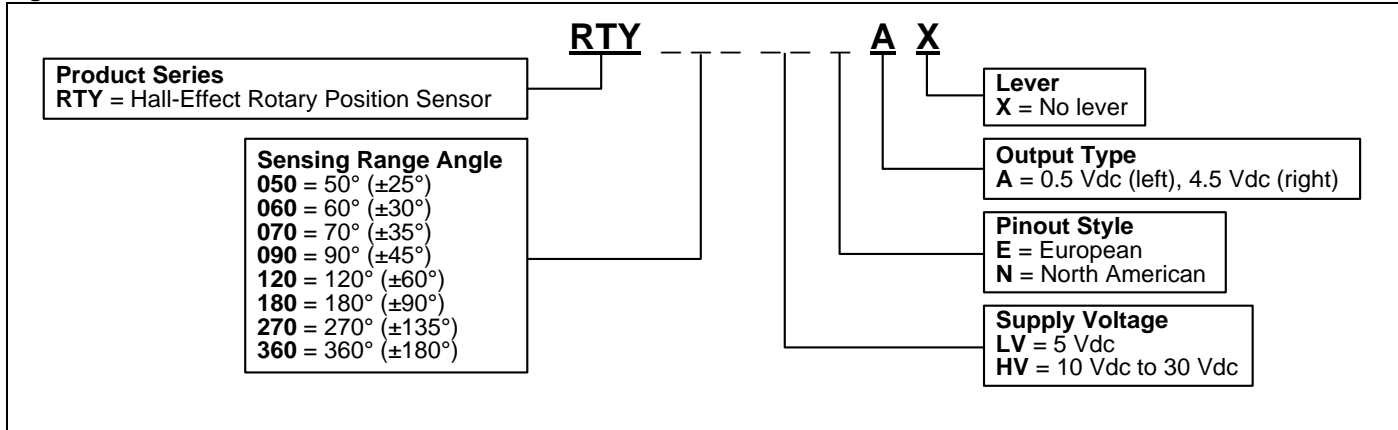

⚠ WARNING
PERSONAL INJURY
 DO NOT USE these products as safety or emergency stop devices or in any other application where failure of the product could result in personal injury.
Failure to comply with these instructions could result in death or serious injury.

WARRANTY/REMEDY

Honeywell warrants goods of its manufacture as being free of defective materials and faulty workmanship. Honeywell's standard product warranty applies unless agreed to otherwise by Honeywell in writing; please refer to your order acknowledgement or consult your local sales office for specific warranty details. If warranted goods are returned to Honeywell during the period of coverage, Honeywell will repair or replace, at its option, without charge those items it finds defective. **The foregoing is buyer's sole remedy and is in lieu of all other warranties, expressed or implied, including those of merchantability and fitness for a particular purpose. In no event shall Honeywell be liable for consequential, special, or indirect damages.**

While we provide application assistance personally, through our literature and the Honeywell web site, it is up to the customer to determine the suitability of the product in the application.

Specifications may change without notice. The information we supply is believed to be accurate and reliable as of this printing. However, we assume no responsibility for its use.

⚠ WARNING
MISUSE OF DOCUMENTATION

- The information presented in this product sheet is for reference only. Do not use this document as a product installation guide.
- Complete installation, operation, and maintenance information is provided in the instructions supplied with each product.

Failure to comply with these instructions could result in death or serious injury.

SALES AND SERVICE

Honeywell serves its customers through a worldwide network of sales offices, representatives and distributors. For application assistance, current specifications, pricing or name of the nearest Authorized Distributor, contact your local sales office or:

E-mail: info.sc@honeywell.com

Internet: www.honeywell.com/sensing

Phone and Fax:

| | |
|---------------|-------------------------|
| Asia Pacific | +65 6355-2828 |
| | +65 6445-3033 Fax |
| Europe | +44 (0) 1698 481481 |
| | +44 (0) 1698 481676 Fax |
| Latin America | +1-305-805-8188 |
| | +1-305-883-8257 Fax |
| USA/Canada | +1-800-537-6945 |
| | +1-815-235-6847 |
| | +1-815-235-6545 Fax |