



D12S1R880D, Non-Isolated, Power Block DC/DC Power Modules: 7.0~13.2Vin, 0.6V~1.8V/80A, 2.5V/70A, 3.3V/65A

The Delphi D12S1R880D, surface mounted, power block is the latest offering from a world leader in power systems technology and manufacturing — Delta Electronics, Inc. The D12S1R880D is the latest offering in the DXP80 family which was developed to address the ever-growing demands of increased current and power densities in networking applications while providing maximum flexibility for system configuration, its benefits can easily be applied to other applications transcending various market segments. The DXP80 family, containing all necessary power components and boasting of a USABLE (55°C, 200LFM) current density of 160A/in² and a power density of up to 890W/in³, is a building block for a new open Digital Power Architecture developed to work with either digital or analog controllers. Measured at 0.5"Wx1.0"Lx0.48"H and rated at 80A of output current, the D12S1R880D is designed to operate with an input voltage from 7V to 13.2V and provide an output voltage adjustable from 0.6V to 3.3V. Each D12S1R880D contains two power trains which can provides either an interleaved single output, or two independent outputs. Multiple D12S1R880D can be used in parallel to serve applications where output currents are in excess of 80A with limitation imposed only by the control circuit, analog or digital. Designed for superior price/performance, the D12S1R880D can provide 1.8V and 80A full load in ambient temperature up to 55°C with 200LFM airflow.

FEATURES

- High efficiency with 200LFM@55°C
95.5%@ 11Vin, 3.3V/65A out
94.7%@ 11Vin, 2.5V/70A out
93.3%@ 11Vin, 1.8V/80A out
91.0%@ 11Vin, 1.0V/80A out
87.0%@ 11Vin, 0.6V/80A out
- High accuracy current sense resistor
±2% tolerance@25°C; 200PPM/°C
- Small size and low profile
- 25.4x12.7x12.2mm
(1.00" x 0.50" x 0.48") (SMD)
- Surface mount
- No minimum load required
- Input UVLO, Output OCP/SCP, OVP
- Parallel Units
- ISO 9000, TL 9000, ISO 14001 certified manufacturing facility

APPLICATIONS

Telecom / DataCom
 Distributed power architectures
 Servers and workstations
 LAN / WAN applications
 Data processing applications

TECHNICAL SPECIFICATIONS

$T_A = 25^\circ\text{C}$, airflow rate = 200 LFM, $V_{in} = 7\text{--}13.2\text{Vdc}$, nominal V_{out} and $F_{sw}=450\text{kHz}$ unless otherwise noted.

PARAMETER	NOTES and CONDITIONS	D12S1R880D			
		Min.	Typ.	Max.	Units
ABSOLUTE MAXIMUM RATINGS					
Input Voltage (Continuous)		0		15	Vdc
Operating Temperature	Environment temperature	-40		85	$^\circ\text{C}$
Storage Temperature		-40		125	$^\circ\text{C}$
INPUT CHARACTERISTICS					
Operating Input Voltage		7.0	11.0	13.2	V
Maximum Input Current	$V_{in}=7\text{V}$, $V_{out}=3.3\text{V}$, $I_{out}=65\text{A}$ with 200LFM@ 55°C			33A	
PWM Rising Threshold	Driver	2.6			V
PWM Falling Threshold				0.6	V
Tri_state Shutdown Window		1.2		2.0	V
Driver Voltage		6.7	7.0	7.3	V
Driver Current	200LFM@ 55°C			150	mA
Recommended controller	LTC3861-1 / TPS40425				
OUTPUT CHARACTERISTICS					
Output Voltage Adjustable Range	$V_{in}=11.0\text{V}$	0.6		3.3	V
Total Output Voltage Regulation	Total Regulation over load, line and temperature		1		% $V_{o,sett}$
Output Voltage Ripple and Noise	$V_{in}=11.0\text{V}$; C_{out} : 6x 330 μF Tan Capacitor + 2x100 μF +4.7 μF ceramic capacitor, BW=20MHz		50		mVpp
Output Voltage Overshoot	turn on		2		% $V_{o,set}$
Output Current Range	0.6V~1.8V dual output - V_{out1} , V_{out2}	0		40	A
	0.6V~1.8V single output - Combine V_{out1} and V_{out2} as one output	0		80	A
	2.5V dual output - V_{out1} , V_{out2}	0		35	A
	2.5V single output - Combine V_{out1} and V_{out2} as one output	0		70	A
	3.3V dual output - V_{out1} , V_{out2}	0		32.5	A
Output Current Range	3.3V single output - Combine V_{out1} and V_{out2} as one output	0		65	A
	Transient Response	$V_{in} = 11.0\text{V}$; I_{out} step: 50%~100%~50% I_{out} ; Slew/Rate: 0.5A/ μS ; C_{out} : 6x 330 μF Tan Capacitor + 2x100 μF +4.7 μF ceramic capacitor, BW=20MHz		90	mVpp
Inductor Value			135		nH
Inductor DCR			0.3		m Ω
Inductor Saturation Current	Peak value at temperature of 100°C		53		A
Output Current Sense Resistor Value	$T_A = 25^\circ\text{C}$		0.25		m Ω
Output Current Sense Resistor Tolerance	$T_A = 25^\circ\text{C}$	-2		2	%
Output Current Sense Resistor Temperature Coefficient			200		PPM/ $^\circ\text{C}$
EFFICIENCY					
	200LFM @ 55°C				
$V_o=0.6\text{V}$	$V_{in}=11.0\text{V}$, $V_o=0.6\text{V}$, $I_o=80\text{A}$		87.0		%
$V_o=1.0\text{V}$	$V_{in}=11.0\text{V}$, $V_o=1.0\text{V}$, $I_o=80\text{A}$		91.0		%
$V_o=1.8\text{V}$	$V_{in}=11.0\text{V}$, $V_o=1.8\text{V}$, $I_o=80\text{A}$		93.3		%
$V_o=2.5\text{V}$	$V_{in}=11.0\text{V}$, $V_o=2.5\text{V}$, $I_o=70\text{A}$		94.7		%
$V_o=3.3\text{V}$	$V_{in}=11.0\text{V}$, $V_o=3.3\text{V}$, $I_o=65\text{A}$		95.5		%
FEATURE CHARACTERISTICS					
Switching Frequency			450		kHz
GENERAL SPECIFICATIONS					
MTBF	Normal input, $I_o=I_{o,max}$, $T_a=40^\circ\text{C}$, 100LFM	3			M hours
Weight			12.5		grams

Block diagram :

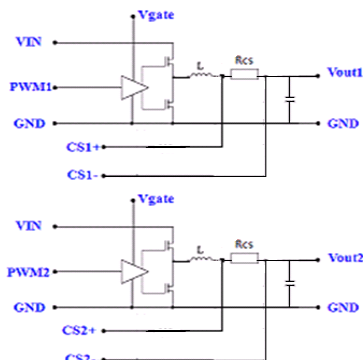

ELECTRICAL CHARACTERISTICS CURVES

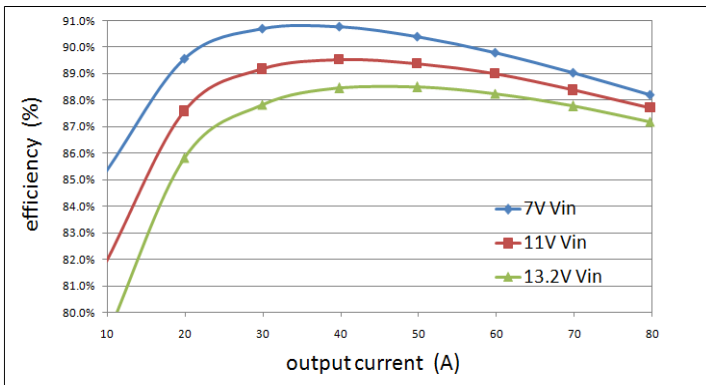

Figure 1: Converter efficiency vs. output current (0.6V output voltage)

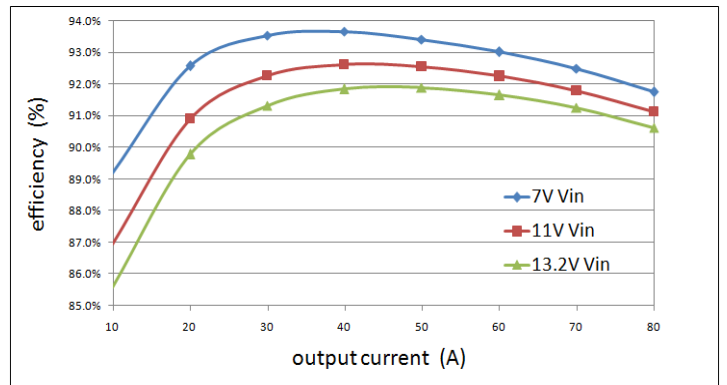

Figure 2: Converter efficiency vs. output current (1.0V output voltage)

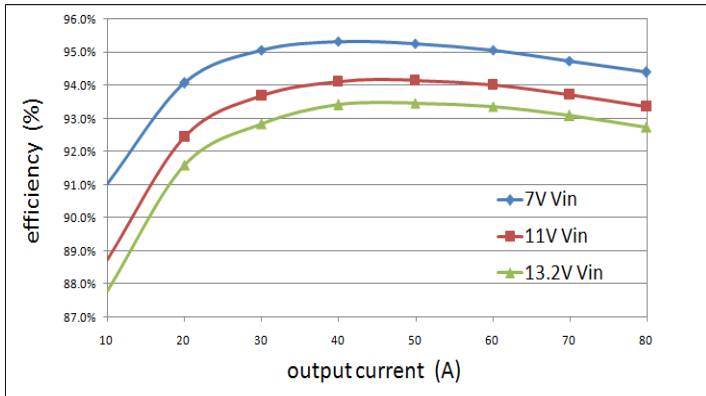

Figure 3: Converter efficiency vs. output current (1.8V output voltage)

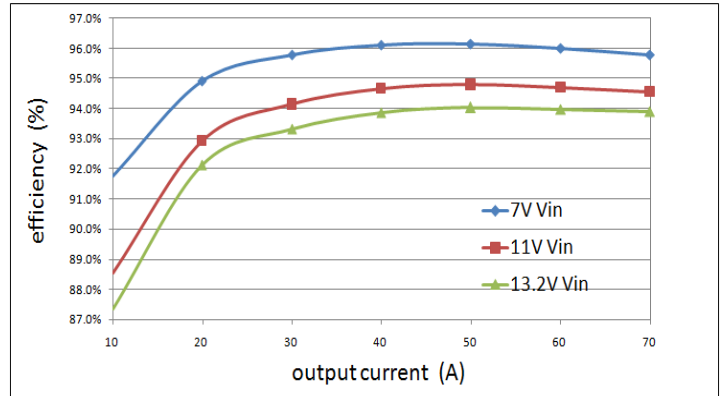

Figure 4: Converter efficiency vs. output current (2.5V output voltage)

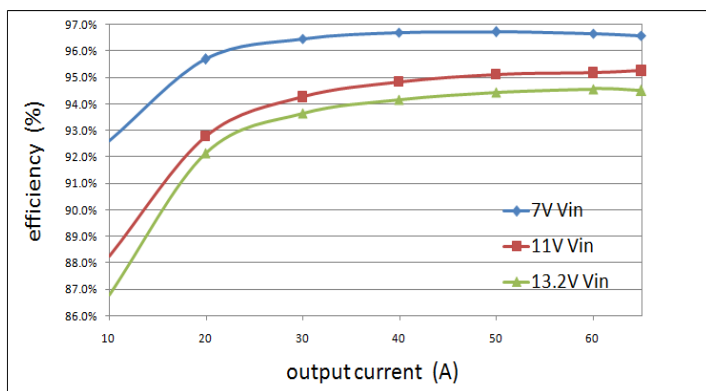

Figure 5: Converter efficiency vs. output current (3.3V output voltage)

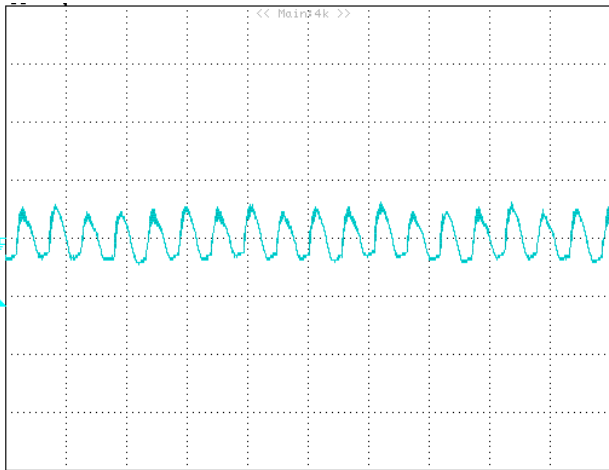

Figure 6: Output ripple & noise at 11.0V_{in}, 0.6V/ 0A out
20mV/div, 2uS/div

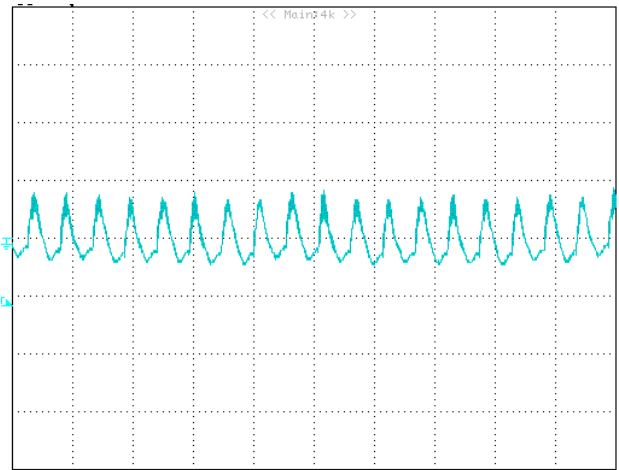

Figure 7: Output ripple & noise at 11.0V_{in}, 0.6V/80A out
20mV/div, 2uS/div

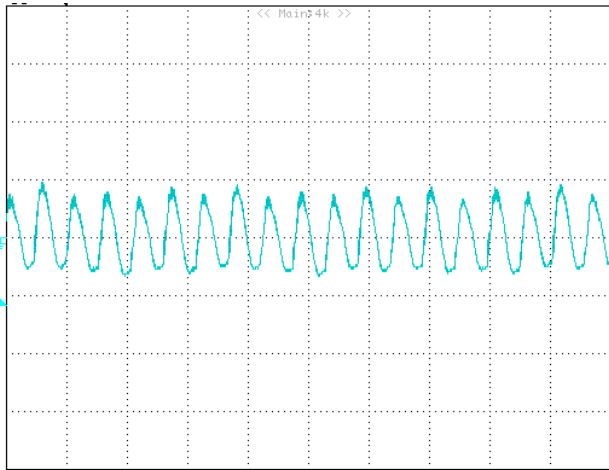

Figure 8: Output ripple & noise at 11.0V_{in}, 1.0V/ 0A out
20mV/div, 2uS/div

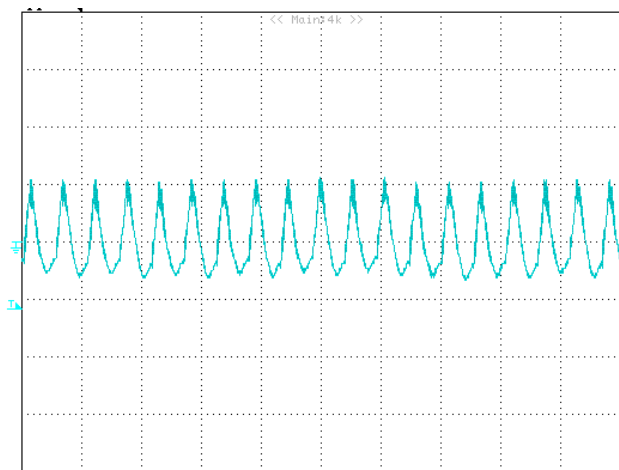

Figure 9: Output ripple & noise at 11.0V_{in}, 1.0V/ 80A out
20mV/div, 2uS/div

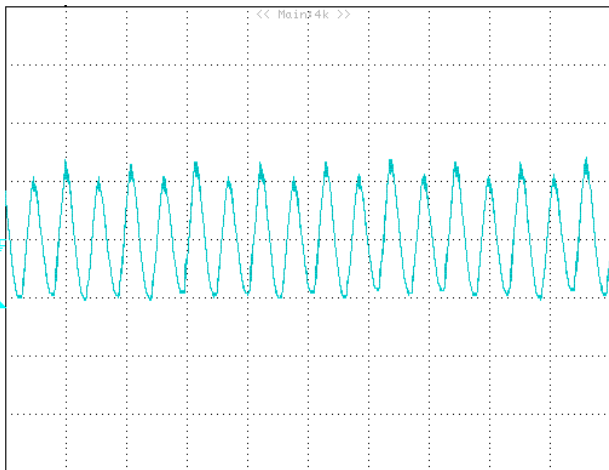

Figure 10: Output ripple & noise at 11.0V_{in}, 1.8V/ 0A out
20mV/div, 2uS/div

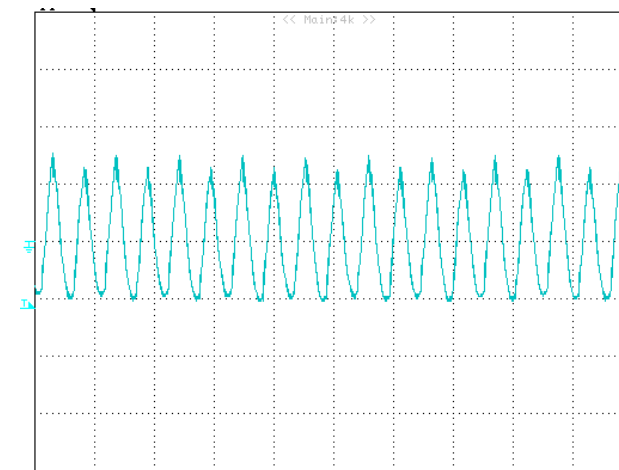

Figure 11: Output ripple & noise at 11.0V_{in}, 1.8V/ 80A out
20mV/div, 2uS/div

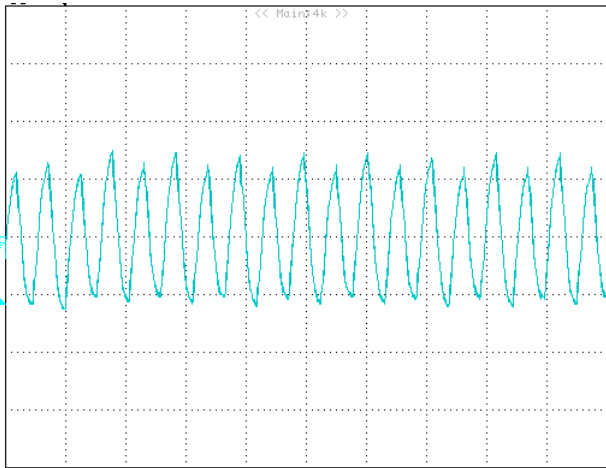

Figure 12: Output ripple & noise at 11.0V_{in}, 2.5V/0A out
20mV/div, 2uS/div

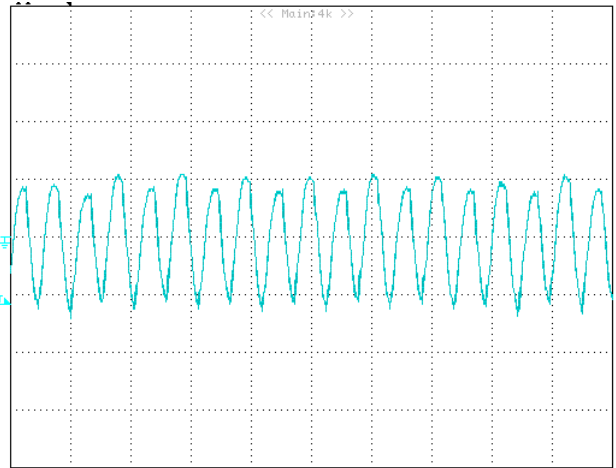

Figure 13: Output ripple & noise at 11.0V_{in}, 2.5V/70A out
20mV/div, 2uS/div

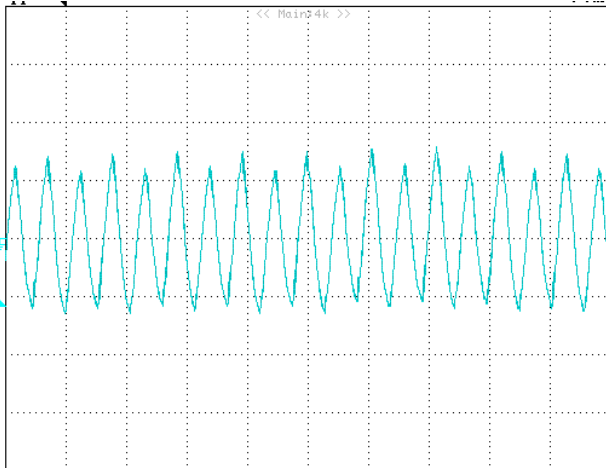

Figure 14: Output ripple & noise at 11.0V_{in}, 3.3V/0A out
20mV/div, 2uS/div

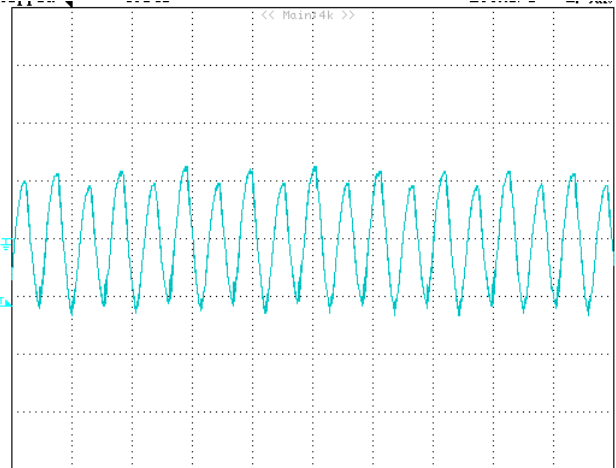

Figure 15: Output ripple & noise at 11.0V_{in}, 3.3V/65A out
20mV/div, 2uS/div

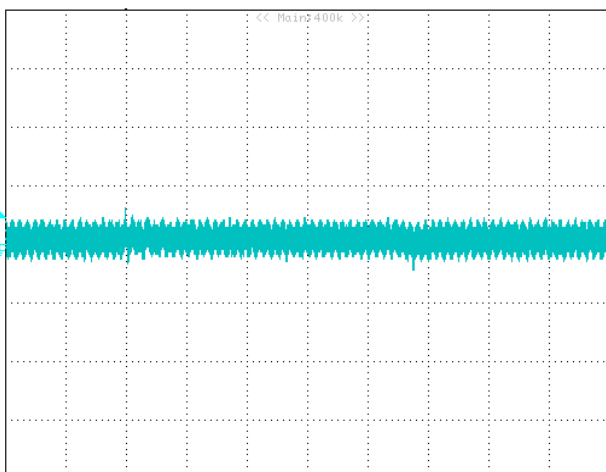

Figure 16: Typical transient response, 11.0V_{in}/0.6V_o
50mV/div, 200uS/div (Load Step: 50% ~ 100%~50% I_{out},
slew rate=0.5A/uS)

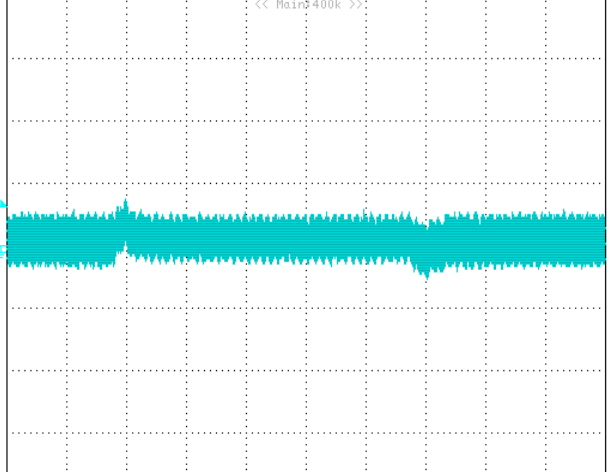

Figure 17: Typical transient response, 11.0V_{in}/1.0V_o
50mV/div, 200uS/div (Load Step: 50% ~ 100%~50% I_{out},
slew rate=0.5A/uS)

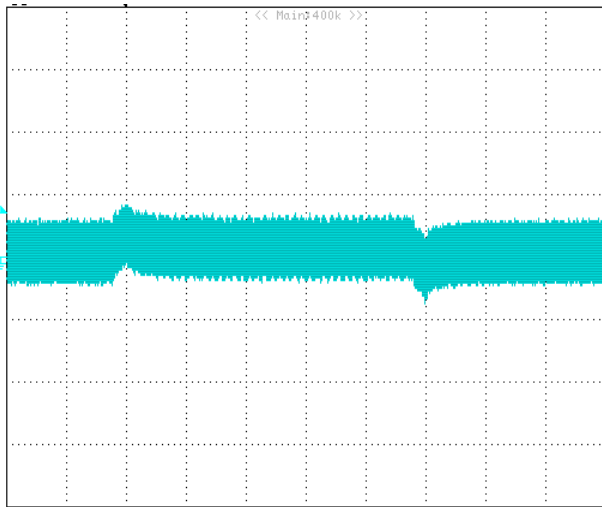

Figure 18: Typical transient response, 11.0Vin/1.8Vo
50mV/div,200uS/div (Load Step: 50% ~ 100%~50% Iout ,
slew rate=0.5A/uS)

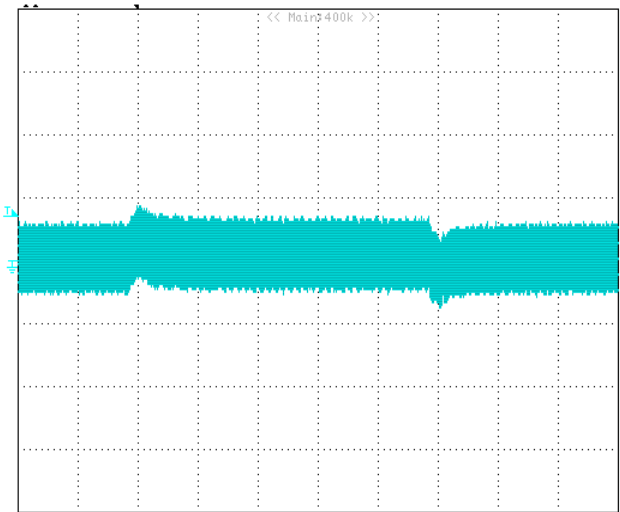

Figure 19: Typical transient response, 11.0Vin/2.5Vo
50mV/div,200uS/div (Load Step: 50% ~ 100%~50% Iout ,
slew rate=0.5A/uS)

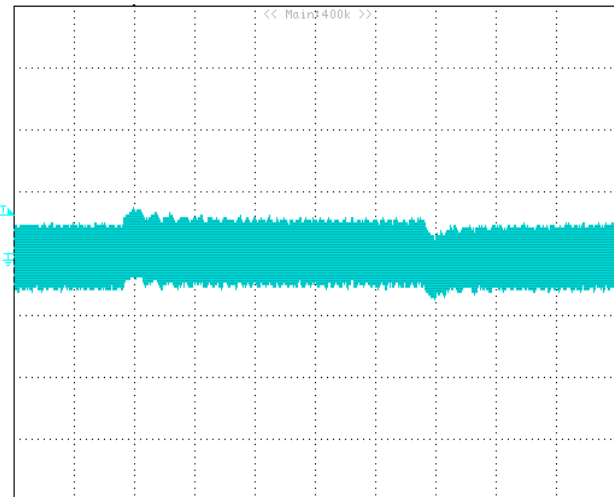

Figure 20: Typical transient response, 11.0Vin/3.3Vo
50mV/div,200uS/div (Load Step: 50% ~ 100%~50% Iout ,
slew rate=0.5A/uS)

TEST CONFIGURATIONS

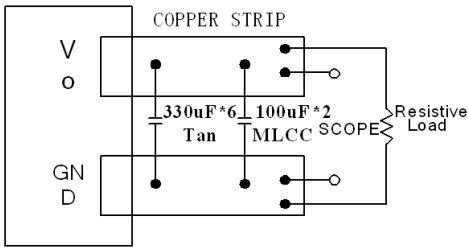

Figure 21: Peak-peak output ripple & noise and startup transient measurement test setup

Note: 6pcs 330 μ F TAN and 2 pcs 100 μ F MLCC capacitor in the module output. Scope measurement should be made by using a BNC connector.

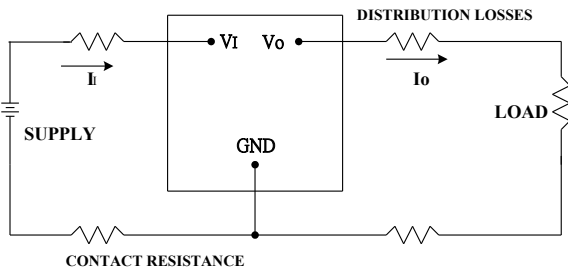

Figure 22: Output voltage and efficiency measurement test setup

Note: All measurements are taken at the module terminals. When the module is not soldered (via socket), place Kelvin connections at module terminals to avoid measurement errors due to contact resistance.

$$\eta = \left(\frac{V_o \times I_o}{V_i \times I_i + V_{driver} \times I_{driver}} \right) \times 100 \%$$

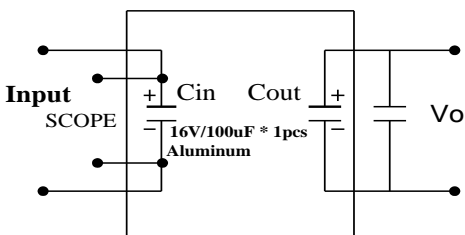

Figure23: Peak-peak Input ripple & noise measurement test setup

DESIGN CONSIDERATIONS

The power module should be connected to a low ac-impedance input source. Highly inductive source impedances can affect the stability of the module. An input capacitance must be placed close to the modules input pins to filter ripple current and ensure module stability in the presence of inductive traces that supply the input voltage to the module.

FEATURES DESCRIPTIONS

Over-Current Protection

To provide protection in an output over load fault condition, the unit is equipped with over-current protection by external controller. When the over-current protection is triggered, the unit will be shutdown and restart after a period of time. The units operate normally once the fault condition is removed.

Over-Temperature Protection

The over-temperature protection was provided by the external circuitry or controller , it can protect our module from thermal damage. If the temperature exceeds the over-temperature threshold the module will shut down.

THERMAL CONSIDERATIONS

Thermal management is an important part of the system design. To ensure proper, reliable operation, sufficient cooling of the power module is needed over the entire temperature range of the module. Convection cooling is usually the dominant mode of heat transfer.

Hence, the choice of equipment to characterize the thermal performance of the power module is a wind tunnel.

Thermal Testing Setup

Delta's DC/DC power modules are characterized in heated vertical wind tunnels that simulate the thermal environments encountered in most electronics equipment. This type of equipment commonly uses vertically mounted circuit cards in cabinet racks in which the power modules are mounted.

The following figure shows the wind tunnel characterization setup. The power module is mounted on a test PWB and is vertically positioned within the wind tunnel.

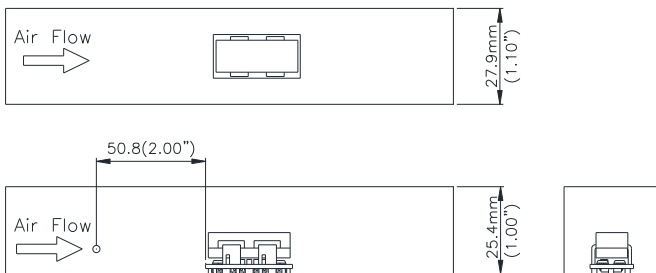

Figure 24: Wind tunnel test setup

Thermal Derating

Heat can be removed by increasing airflow over the module. To enhance system reliability; the power module should always be operated below the maximum operating temperature. If the temperature exceeds the maximum module temperature, reliability of the unit may be affected.

THERMAL CURVES

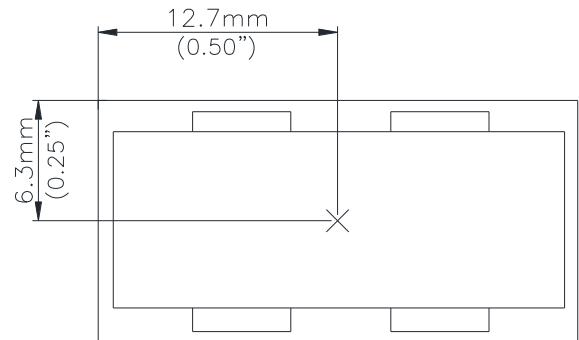

Figure 25: * Hot spot temperature measured point.

The allowed maximum hot spot temperature is defined at 115°C.

THERMAL CURVES (3.3VOUT)

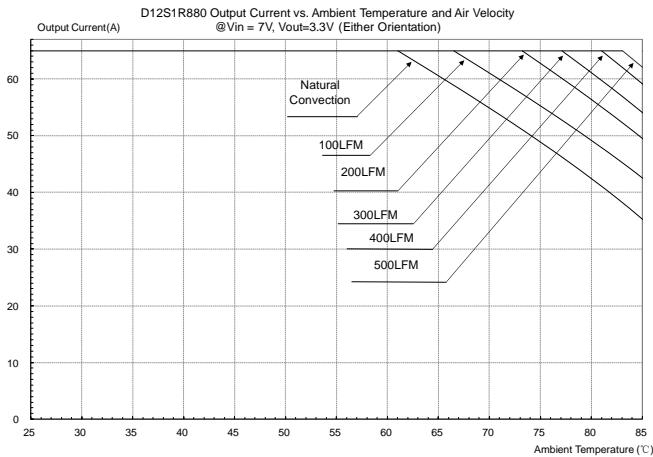

Figure 26: Output current vs. ambient temperature and air velocity @ $V_{in}=7V$, $V_{out}=3.3V$ (Either Orientation)

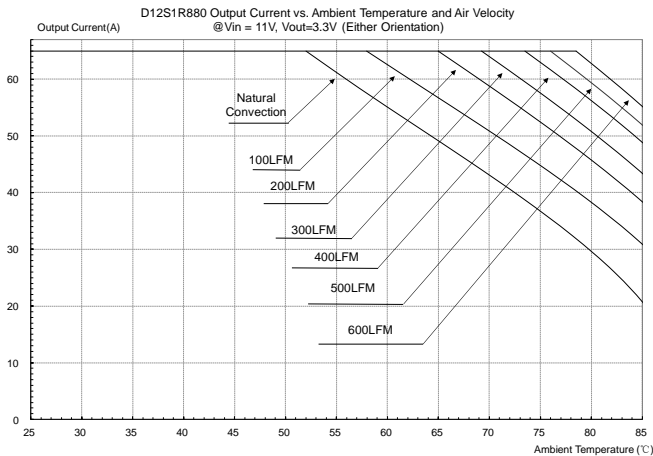

Figure 27: Output current vs. ambient temperature and air velocity @ $V_{in}=11V$, $V_{out}=3.3V$ (Either Orientation)

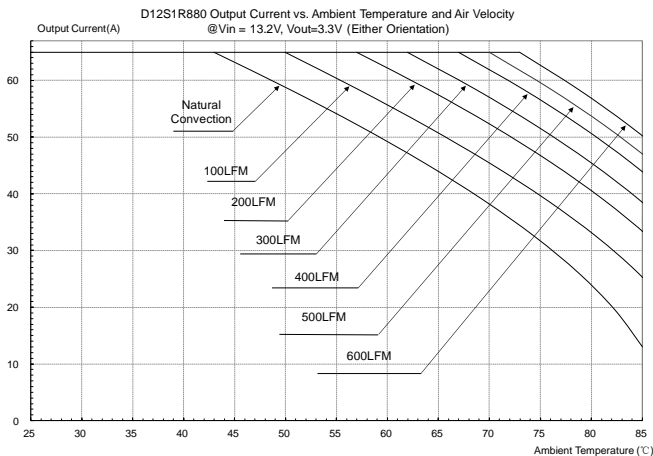

Figure 28: Output current vs. ambient temperature and air velocity @ $V_{in}=13.2V$, $V_{out}=3.3V$ (Either Orientation)

THERMAL CURVES (2.5VOUT)

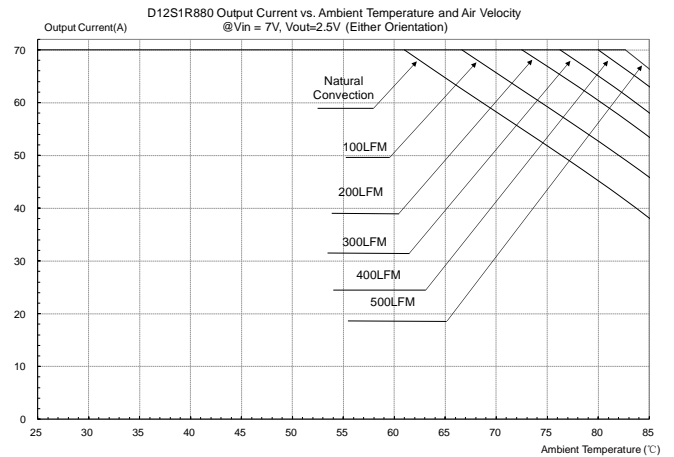

Figure 29: Output current vs. ambient temperature and air velocity @ $V_{in}=7V$, $V_{out}=2.5V$ (Either Orientation)

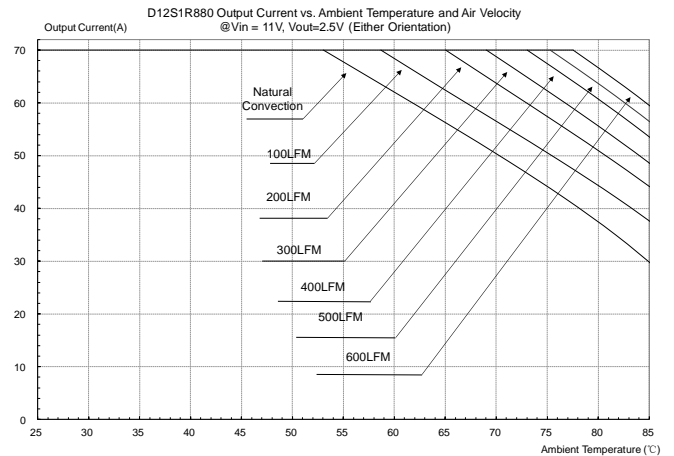

Figure 30: Output current vs. ambient temperature and air velocity @ $V_{in}=11V$, $V_{out}=2.5V$ (Either Orientation)

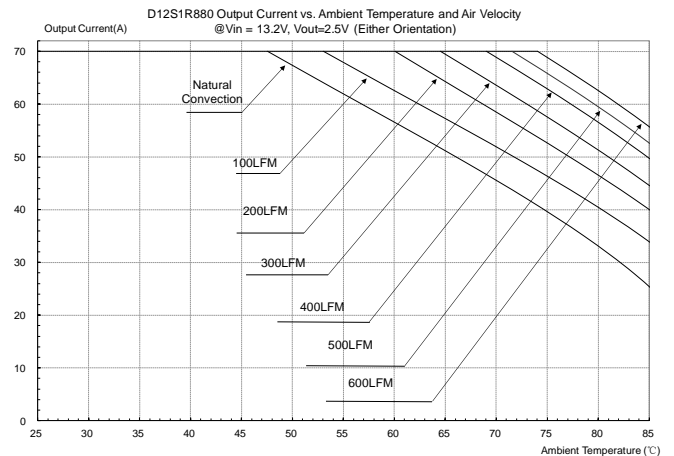

Figure 31: Output current vs. ambient temperature and air velocity @ $V_{in}=13.2V$, $V_{out}=2.5V$ (Either Orientation)

THERMAL CURVES(1.8VOUT)

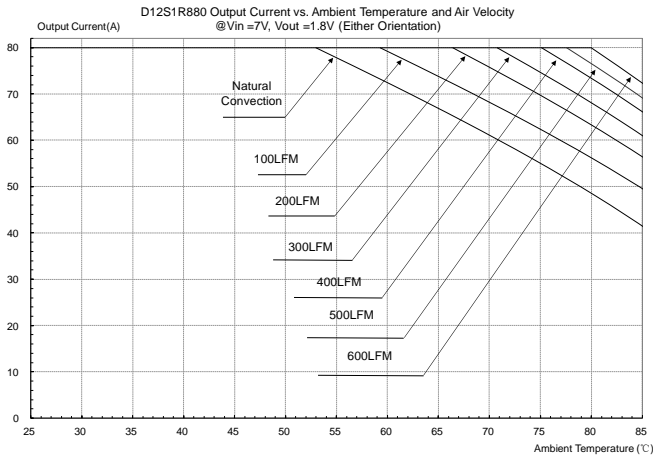

Figure 32: Output current vs. ambient temperature and air velocity @ $V_{in}=7V$, $V_{out}=1.8V$ (Either Orientation)

THERMAL CURVES(1.0VOUT)

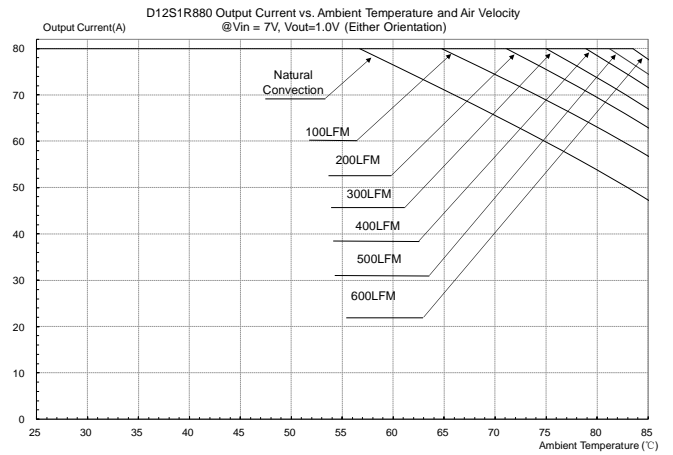

Figure 35: Output current vs. ambient temperature and air velocity @ $V_{in}=7V$, $V_{out}=1.0V$ (Either Orientation)

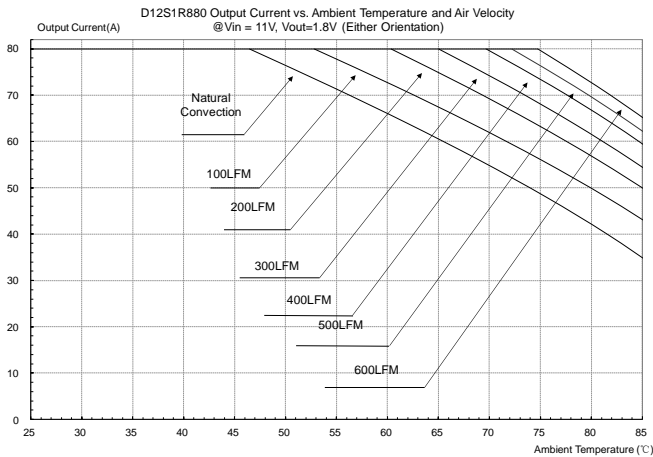

Figure 33: Output current vs. ambient temperature and air velocity @ $V_{in}=11V$, $V_{out}=1.8V$ (Either Orientation)

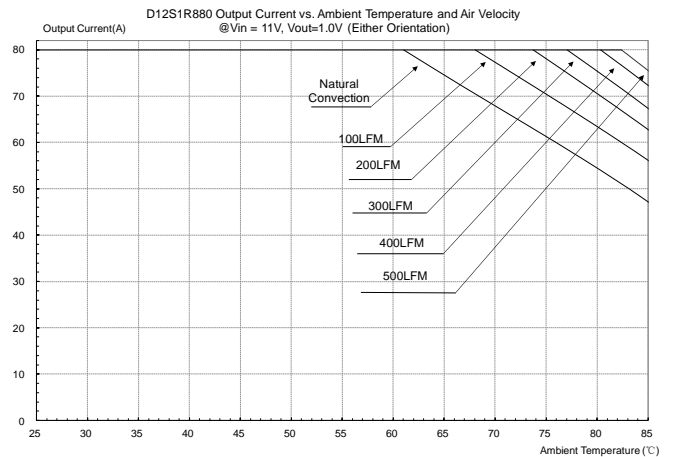

Figure 36: Output current vs. ambient temperature and air velocity @ $V_{in}=11V$, $V_{out}=1.0V$ (Either Orientation)

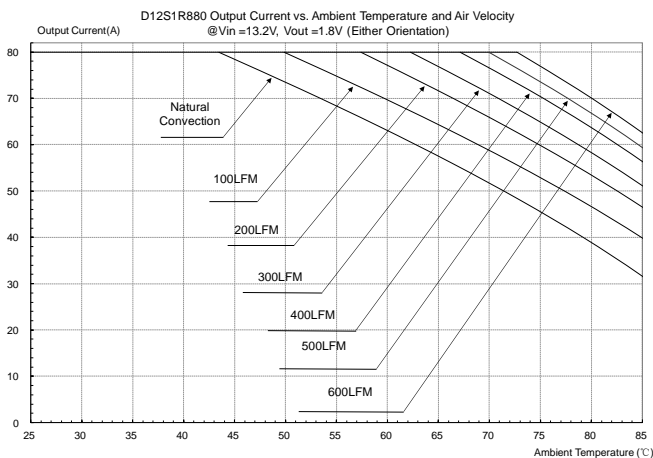

Figure 34: Output current vs. ambient temperature and air velocity @ $V_{in}=13.2V$, $V_{out}=1.8V$ (Either Orientation)

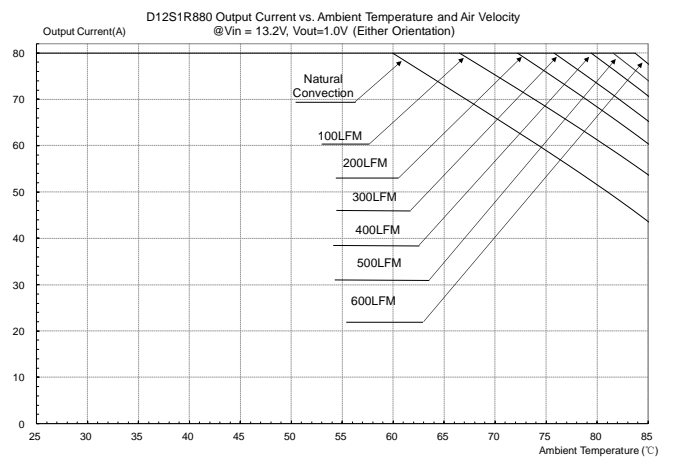

Figure 37: Output current vs. ambient temperature and air velocity @ $V_{in}=13.2V$, $V_{out}=1.0V$ (Either Orientation)

THERMAL CURVES(0.6VOUT)

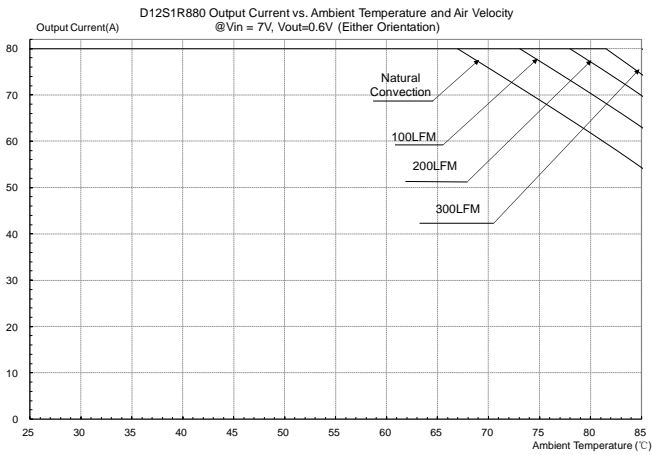

Figure 38: Output current vs. ambient temperature and air velocity @ Vin=7V, Vout=0.6V (Either Orientation)

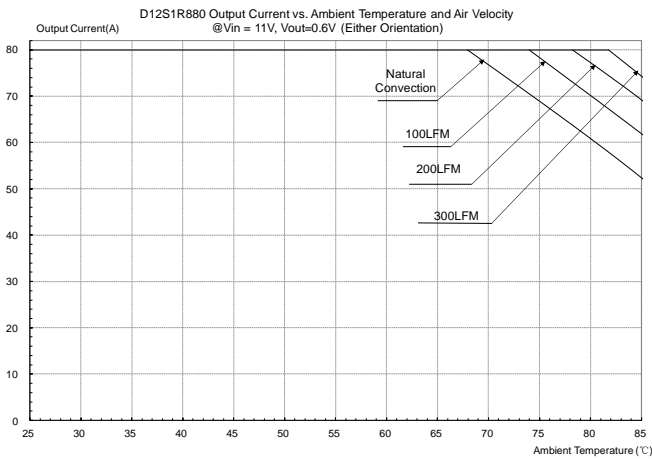

Figure 39: Output current vs. ambient temperature and air velocity @ Vin=11V, Vout=0.6V (Either Orientation)

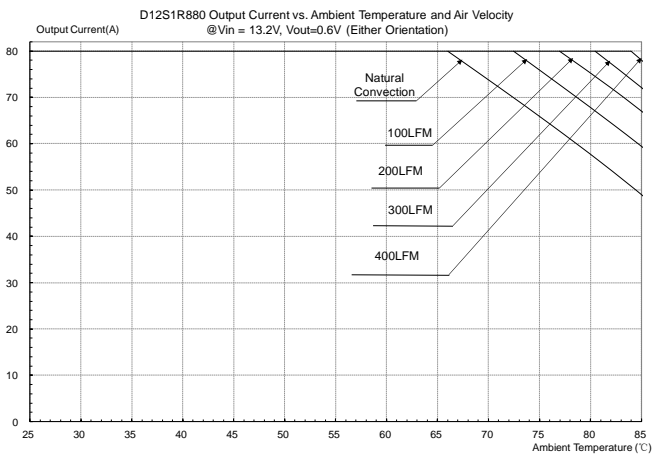
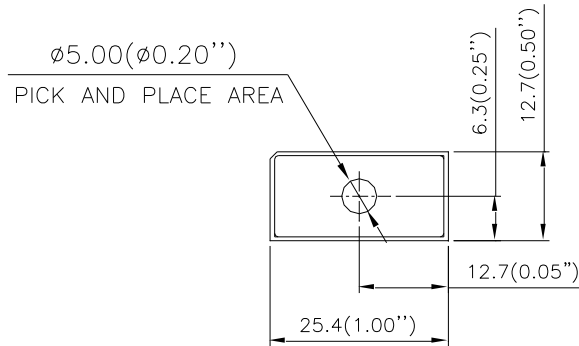

Figure 40: Output current vs. ambient temperature and air velocity @ Vin=13.2V, Vout=0.6V (Either Orientation)

MECHANICAL CONSIDERATIONS

SURFACE-MOUNT TAPE & REEL



NOTES:
 DIMENSIONS ARE IN MILLIMETERS AND (INCHES)
 TOLERANCES: X.Xmm±0.5mm(X.XX in.±0.02 in.)
 X.XXmm±0.25mm(X.XXX in.±0.010 in.)

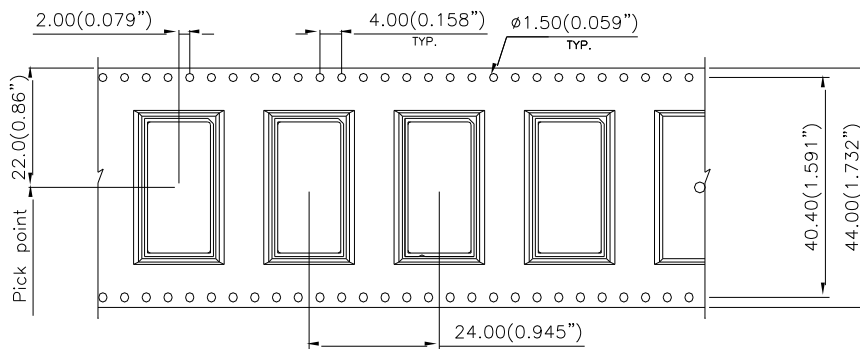

FEED DIRECTION →

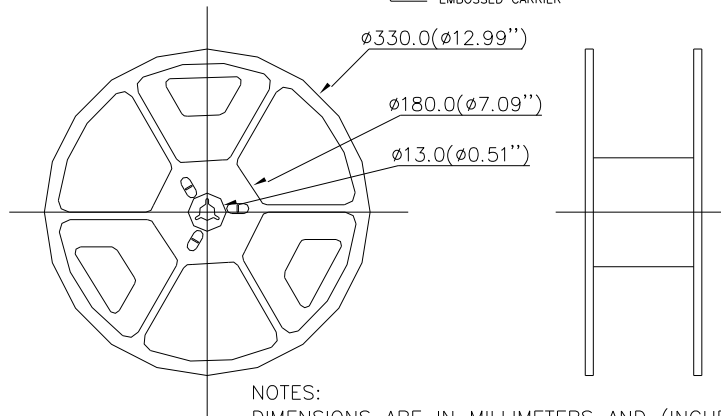
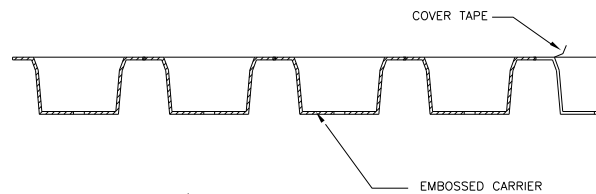

NOTES:
 DIMENSIONS ARE IN MILLIMETERS AND (INCHES)
 TOLERANCES: X.Xmm±0.5mm(X.XX in.±0.02 in.)
 X.XXmm±0.25mm(X.XXX in.±0.010 in.)

LEADED (SN/PB) PROCESS RECOMMEND TEMP. PROFILE

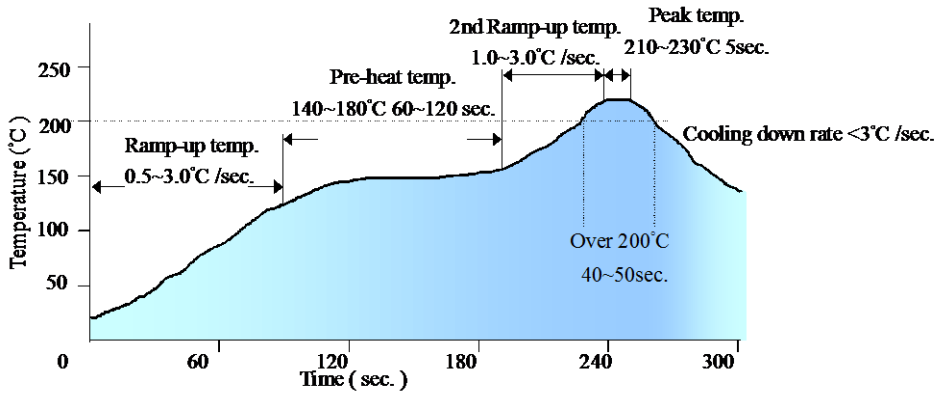

Note: The temperature refers to the pin of D12S1R880D, measured on the pin +Vout joint.

LEAD FREE (SAC) PROCESS RECOMMEND TEMP. PROFILE

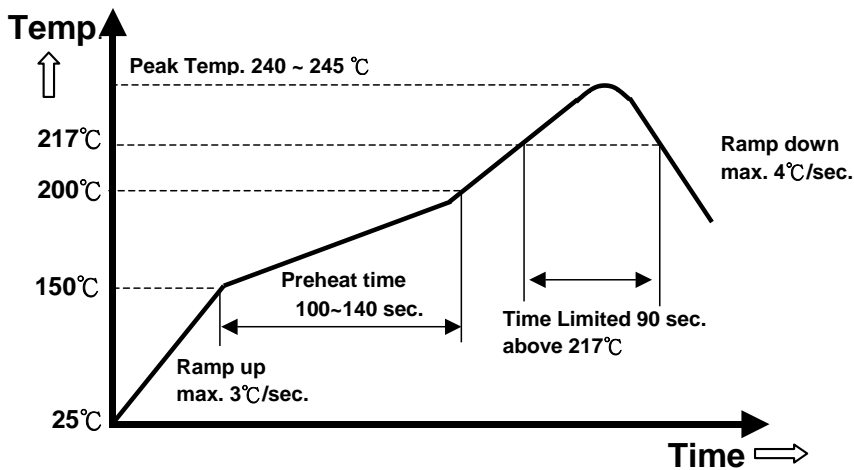

Note: The temperature refers to the pin of D12S1R880D, measured on the pin +Vout joint.

MECHANICAL DRAWING

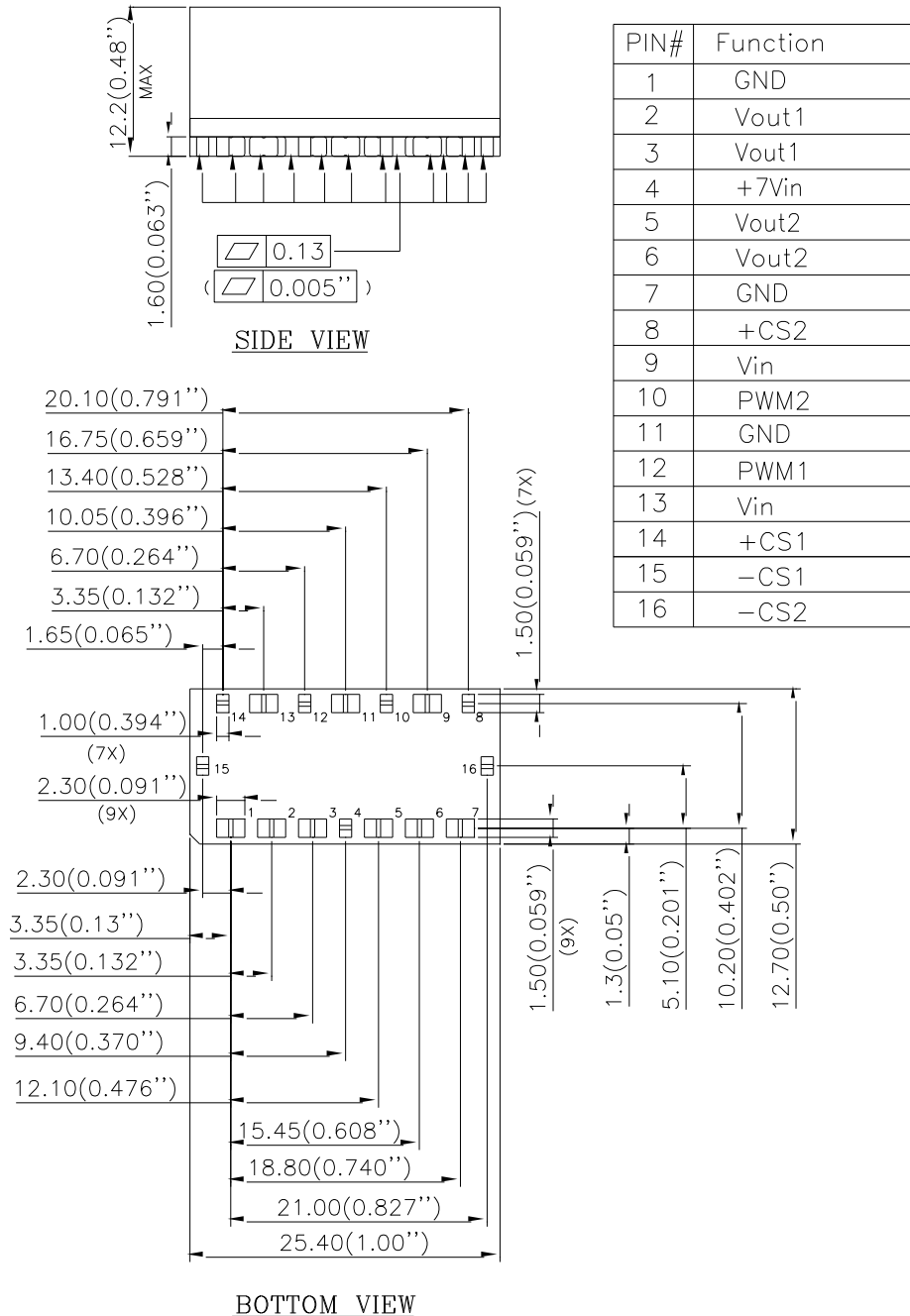

NOTES:
 DIMENSIONS ARE IN MILLIMETERS AND (INCHES)
 TOLERANCES: X.Xmm±0.5mm(X.XX in.±0.02 in.)
 X.XXmm±0.25mm(X.XXX in.±0.010 in.)

All pins are copper alloy with Matte Tin plated over Ni under-plating.

RECOMMENDED PAD LAYOUT

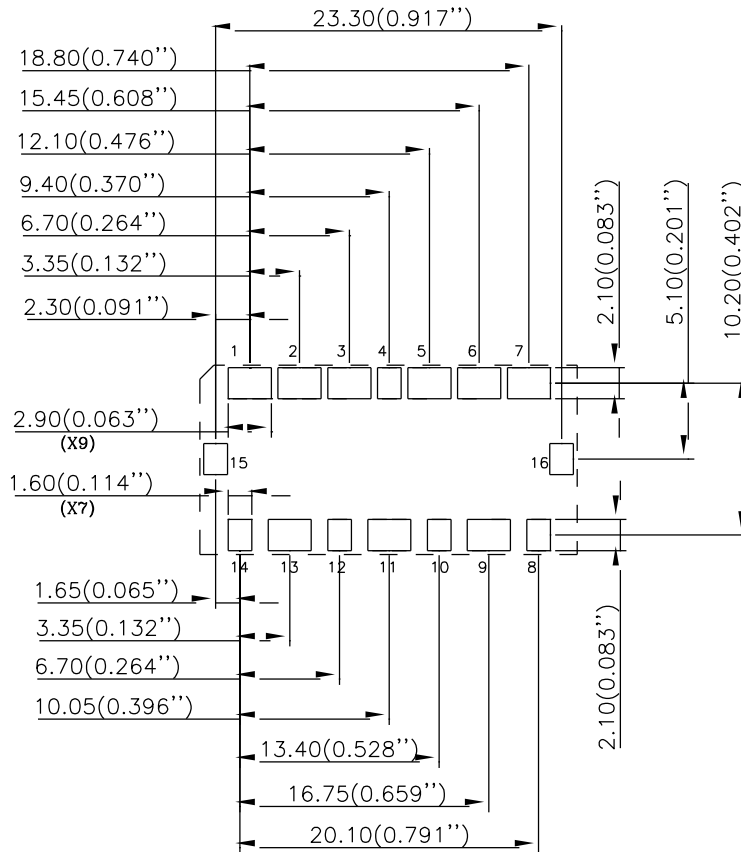

RECOMMENDED PAD LAYOUT

NOTES:

DIMENSIONS ARE IN MILLIMETERS AND (INCHES)

TOLERANCES: X.Xmm±0.5mm(X.XX in.±0.02 in.)

X.XXmm±0.25mm(X.XXX in.±0.010 in.)



PART NUMBERING SYSTEM

D	12	S	1R8	80	D
Type of Product	Input Voltage	Number of Outputs	Output Voltage	Output Current	Option Code
DC/DC modules	7.0~ 12.0 ~13.2V	Single	0.6~1.8~3.3V	80A max	D-Standard

MODEL LIST

Model Name	Input Voltage	Output Voltage	Output Current	RoHS	Total Height	Efficiency 11Vin, 3.3Vout @ 100% load
D12S1R880D	7.0 ~ 13.2Vdc	0.6 ~ 3.3V	80A Max	RoHS 6/6	0.48"	95.2%

CONTACT: www.deltaww.com/dcdc Email: dcdc@deltaww.com

USA:

Telephone:
East Coast: 978-656-3993
West Coast: 510-668-5100
Fax: (978) 656 3964

Europe:

Telephone: +31-20-655-0967
Fax: +31-20-655-0999

Asia & the rest of world:

Telephone: +886 3 4526107 x6220~6224
Fax: +886 3 4513485

WARRANTY

Delta offers a two (2) year limited warranty. Complete warranty information is listed on our web site or is available upon request from Delta.

Information furnished by Delta is believed to be accurate and reliable. However, no responsibility is assumed by Delta for its use, nor for any infringements of patents or other rights of third parties, which may result from its use. No license is granted by implication or otherwise under any patent or patent rights of Delta. Delta reserves the right to revise these specifications at any time, without notice.