

IJ5H SERIES

(4.00 mm) .1575"

50 Ω HYBRID RF CABLE ASSEMBLY

SPECIFICATIONS

For complete specifications and recommended PCB layouts see www.samtec.com?IJ5H

- Insulator Material:** Black LCP
- Contact Material:** Copper Alloy
- Pin Material:** Copper Alloy
- Dielectric Material:** Black LCP
- Plating:** Au over 50 μ" (1.27 μm) Ni
- Operating Temp Range:** -40 °C to +90 °C
- RoHS Compliant:** Yes

- Cable (-2):**
- Conductor Size:** 26 AWG, (0.51 mm) .020" dia.
- Conductor Material:** Silver and Copper Plated Steel Wire
- Insulator Diameter:** (1.52 mm) .060"
- Insulator Material:** PTFE
- Shield Material:** Silver Plated Copper Wire
- Jacket Material:** FEP
- Jacket Diameter:** (2.54 mm) .100"
- Bend Radius:** 12.7 mm
- Impedance:** 50 Ω
- Current Rating:** 5A DC
- RoHS Compliant:** Yes

Mates with:
IP5, SMA, MCX, MMCX, SMB5

Low-cost isolated transmission line system

RG 316 Cable

1, 2, 4, 6 or 8 Positions

Positive latching

Choice of traditional RF end options

EDGE RATE
CONTACT

IJ5H	NO. OF POSITIONS	ASSEMBLED LENGTH	END 1 PLATING	CABLE TYPE	END 2 OPTION										
	-01, -02, -04, -06, -08	- "XXXX" = Assembled Length in millimeters -0300 to -1000 (1000 mm) 39.40" maximum	-S = 30 μ" (0.76 μm) Gold on contact	-2 = RG 316 cable	<table border="1"> <tr> <td>All Gold</td> <td>Gold/Nickel combination</td> </tr> <tr> <td>-01SP1 = SMA Straight Plug</td> <td>-02SP2 = MCX Straight Plug</td> </tr> <tr> <td>-02SP1 = MCX Straight Plug</td> <td>-03SP2 = MMCX Straight Plug</td> </tr> <tr> <td>-03SP1 = MMCX Straight Plug</td> <td>-07SP2 = SMB Straight Plug</td> </tr> <tr> <td>-07SP1 = SMB Straight Plug</td> <td></td> </tr> </table>	All Gold	Gold/Nickel combination	-01SP1 = SMA Straight Plug	-02SP2 = MCX Straight Plug	-02SP1 = MCX Straight Plug	-03SP2 = MMCX Straight Plug	-03SP1 = MMCX Straight Plug	-07SP2 = SMB Straight Plug	-07SP1 = SMB Straight Plug	
All Gold	Gold/Nickel combination														
-01SP1 = SMA Straight Plug	-02SP2 = MCX Straight Plug														
-02SP1 = MCX Straight Plug	-03SP2 = MMCX Straight Plug														
-03SP1 = MMCX Straight Plug	-07SP2 = SMB Straight Plug														
-07SP1 = SMB Straight Plug															

NO. OF POSITIONS	A
-01	(20.87) .822
-02	(24.87) .979
-04	(32.87) 1.294
-06	(40.87) 1.609
-08	(48.87) 1.924

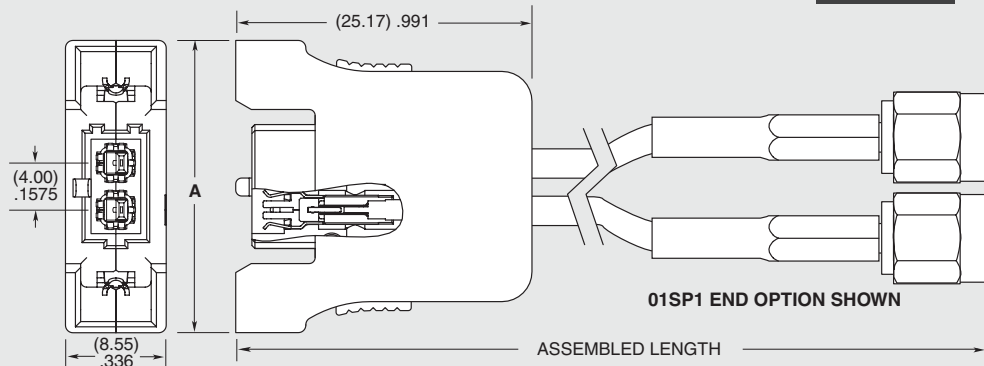

Note:
This Series is non-standard, non-returnable.

Due to technical progress, all designs, specifications and components are subject to change without notice.

WWW.SAMTEC.COM

All parts within this catalog are built to Samtec's specifications. Customer specific requirements must be approved by Samtec and identified in a Samtec customer-specific drawing to apply.