

# FBAR/SAW Devices (SAW Duplexers)

## D5PF788M0M3Y9

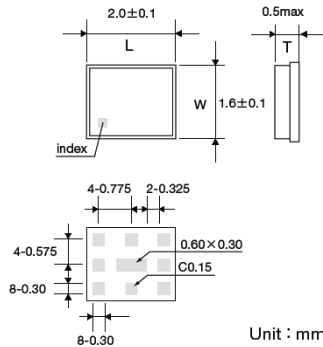

### ■ Features

- Item Summary  
SAW, Duplexer, 2.0x1.6x0.5mm  
Band28
- Lifecycle Stage  
Mass Production
- Standard packaging quantity (minimum)  
Taping Embossed 3000 , 15000pcs

### ■ Products characteristics table

System	LTE
Type	SAW
Function	Duplexer
band	Band28
Insertion Loss (typ) (Tx-ANT/ANT-Rx)	1.8/2.4 dB
Isolation (typ)	60/54 dB
Operating Temp. Range	-20 to +85 °C
RoHS2 Compliance (10 subst.)	Yes
REACH Compliance (168 subst.)	Yes
Soldering	Reflow

### ■ External Dimensions

Dimension L	2.0 ± 0.10 mm
Dimension W	1.6 ± 0.10 mm
Dimension T	Max 0.5 mm

2016.06.28

The data is reference only. Electrical characteristics vary depending on environment or measurement condition.  
 TAIYO YUDEN reserves the right to make change to the Date at any time without notice.  
 Before making final selection, please check product specification.



MSL1

\* Pb Free Part

Customer Name	Standard	TAIYO YUDEN Mobile Technology Co.,Ltd.	
System	Band 28 Block B Duplexer	Date	Apr. 4, 2014
Part Number	D5PF788M0M3Y9	Version 3.2ccB	Final

**Table 1. Electrical Specification**

Item		Condition (MHz)	Specification			Unit	Remarks	
			Min	Typ	Max			
Tx to ANT	Insertion loss	718~748	-	1.8	2.8	dB (*1)		
	Ripple	718~748	-	0.9	2.3	dB		
	VSWR	ANT	718~748	-	1.9	2.3	-	
		Tx		-	1.9	2.3	-	
	Input power	718~748	CW tone, +28.5dBm, 5000H			-	Ta=50°C	
	Absolute attenuation	10~698	33	38	-	dB		
		698~710	10	50	-	dB		
		758~773	20	43	-	dB		
		773~803	47	53	-	dB		
		1436~1496	35	47	-	dB		
1565~1606		40	51	-	dB			
2154~2244		45	57	-	dB			
2400~2500	45	56	-	dB				
ANT to Rx	Insertion loss	773~803	-	2.4	2.9	dB (*1)		
	Ripple	773~803	-	0.8	1.7	dB		
	VSWR	ANT	773~803	-	1.7	2.2	-	
		Rx		-	2.0	2.4	-	
	Absolute attenuation	718~748	50	59	-	dB		
2400~2500		45	50	-	dB			
Tx to Rx	Isolation	718~748	56	60	-	dB		
		773~803	50	54	-	dB		
Terminating Impedance		Tx port	50 + 12nH			Ohm	Single-ended	
		Rx port	50			Ohm	Single-ended	
		Ant port	50 // 10nH			Ohm	Single-ended	
Operating Temperature			-20 to +85			°C		
Device size (LxWxH)			2.0(typ) x 1.6(typ) x 0.5(max)			mm		

(\*1) Specification of insertion loss excludes loss that comes from the test board.



MSL1

\* Pb Free Part

Customer Name	Standard	TAIYO YUDEN Mobile Technology Co.,Ltd.	
System	Band 28 Block B Duplexer	Date	Apr. 4, 2014
Part Number	D5PF788M0M3Y9	Version 3.2ccB	Final

### Dimensions

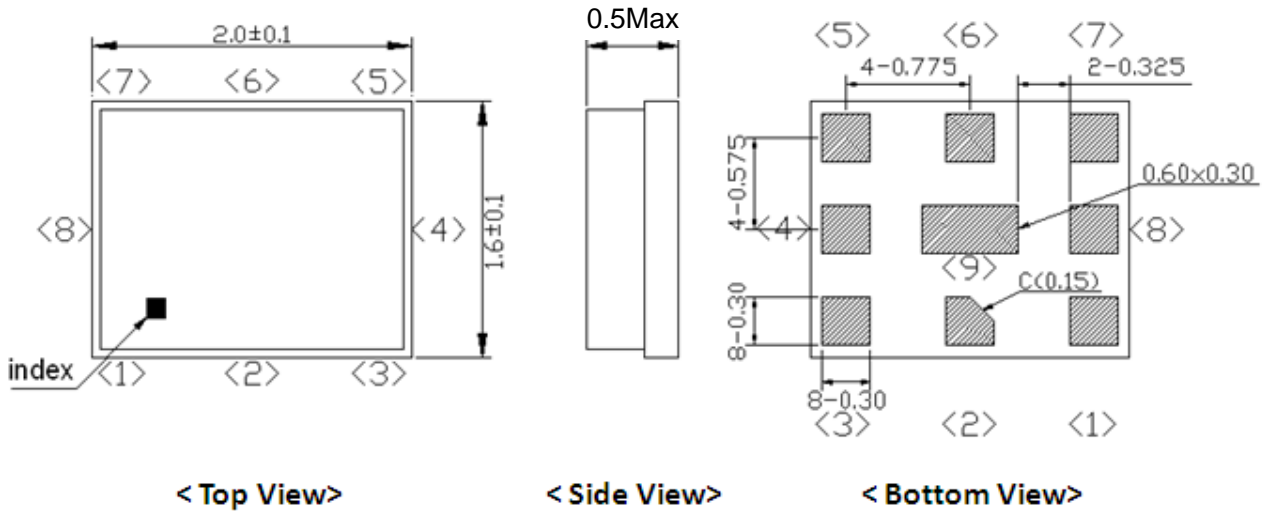

Unit: mm

### Pin Configuration

Pin No.	Pin name	Description
1	Rx	Receiver Pin
2	GND	Ground Pin
3	Tx	Transmitter Pin
4	GND	Ground Pin
5	GND	Ground Pin
6	ANT	Antenna Pin
7	GND	Ground Pin
8	GND	Ground Pin
9	GND	Ground Pin

**Figure 1. Dimensions and Pin assignment**



MSL1

\* Pb Free Part

Customer Name	Standard	TAIYO YUDEN Mobile Technology Co.,Ltd.	
System	Band 28 Block B Duplexer	Date	Apr. 4, 2014
Part Number	D5PF788M0M3Y9	Version 3.2ccB	Final

### Evaluation Circuit

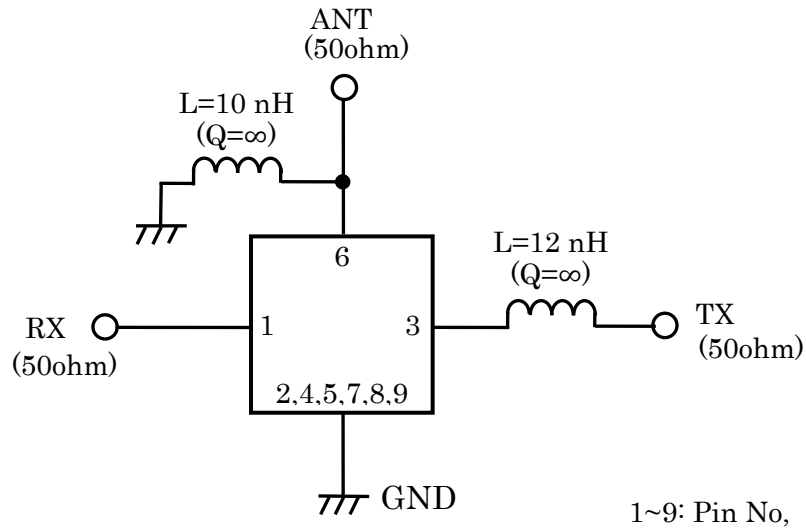

### Recommended foot print pattern

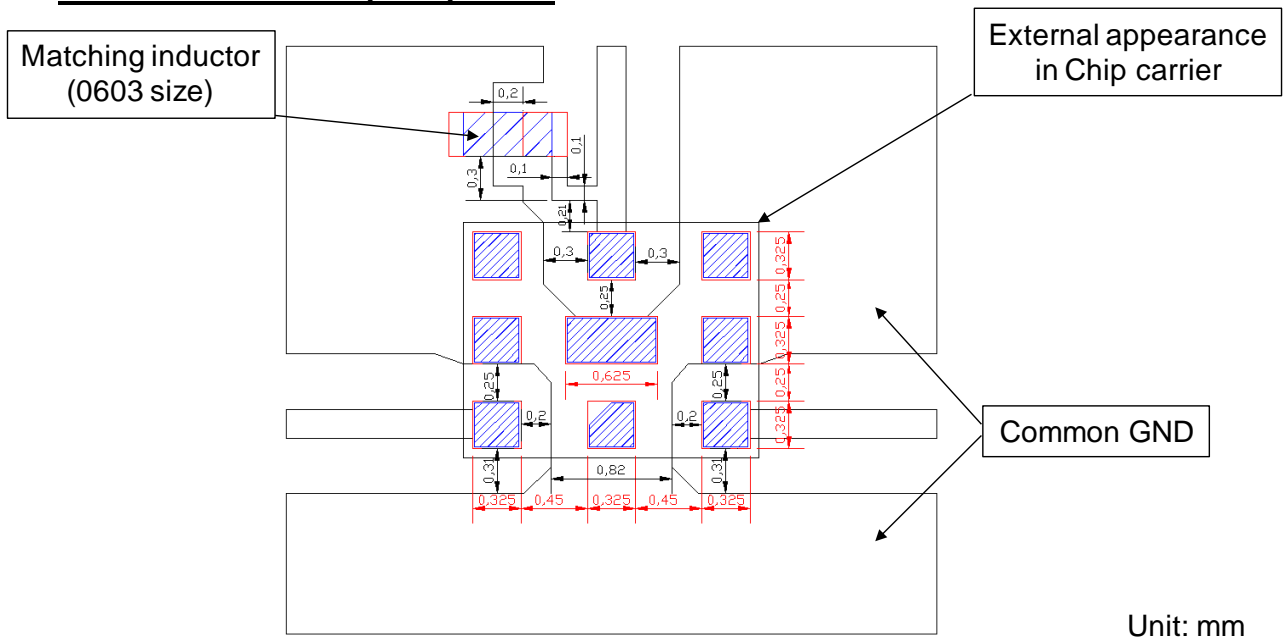

Figure 2. Recommended foot print pattern



MSL1

\* Pb Free Part

Customer Name	Standard	TAIYO YUDEN Mobile Technology Co.,Ltd.	
System	Band 28 Block B Duplexer	Date	Apr. 4, 2014
Part Number	D5PF788M0M3Y9	Version 3.2ccB	Final

### Tx to Ant

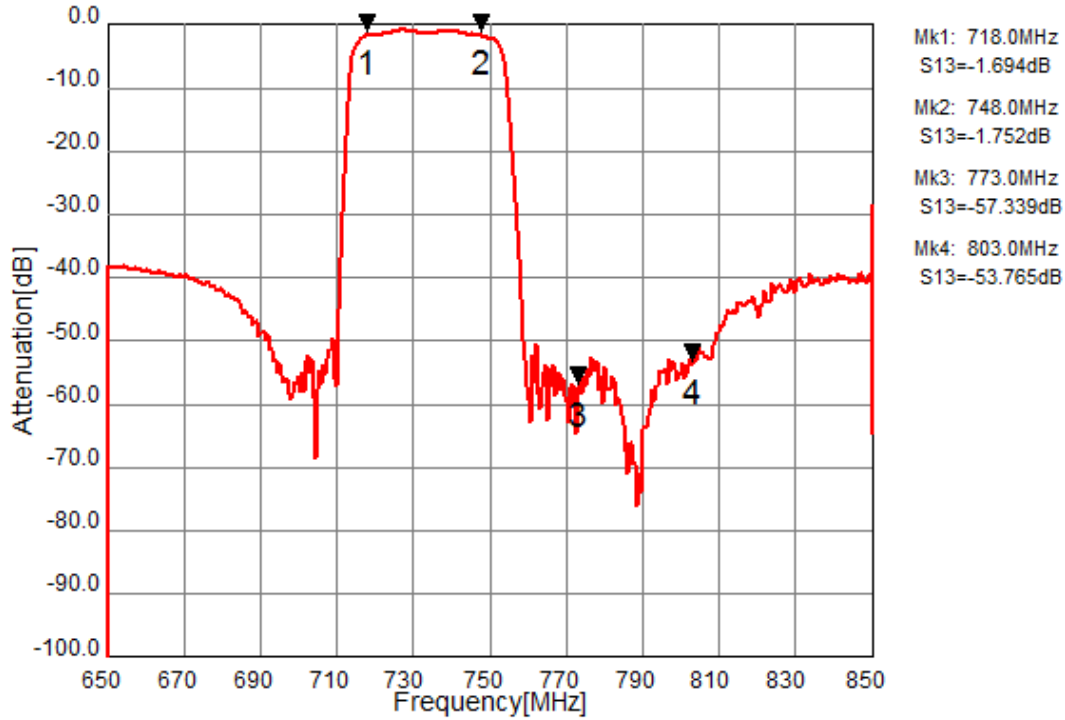

### Ant to Rx

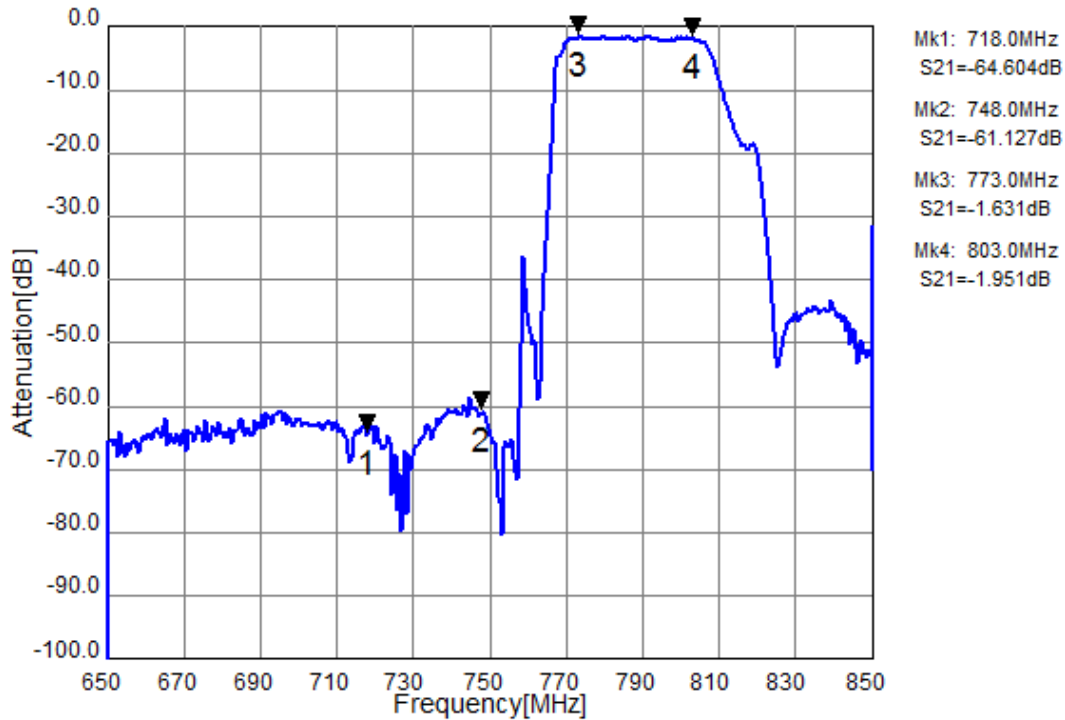

**Figure 3-1. Electrical Characteristics**

These data exclude loss that comes from the test board.



MSL1

\* Pb Free Part

Customer Name	Standard	TAIYO YUDEN Mobile Technology Co.,Ltd.	
System	Band 28 Block B Duplexer	Date	Apr. 4, 2014
Part Number	D5PF788M0M3Y9	Version 3.2ccB	Final

## Tx to Ant, Ant to Rx

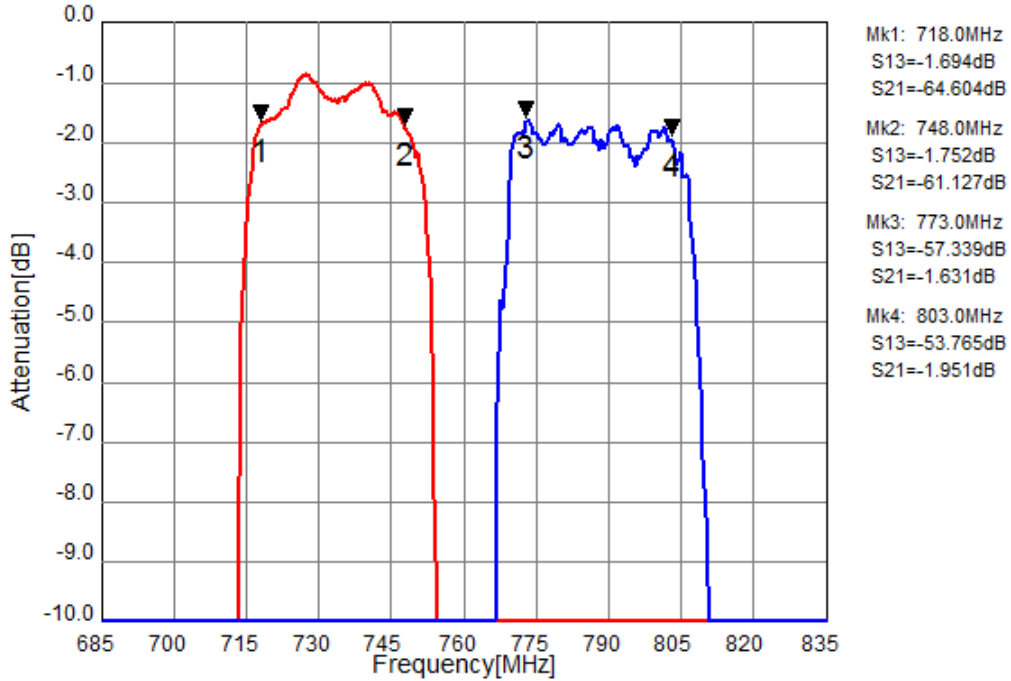

## Tx to Rx Isolation

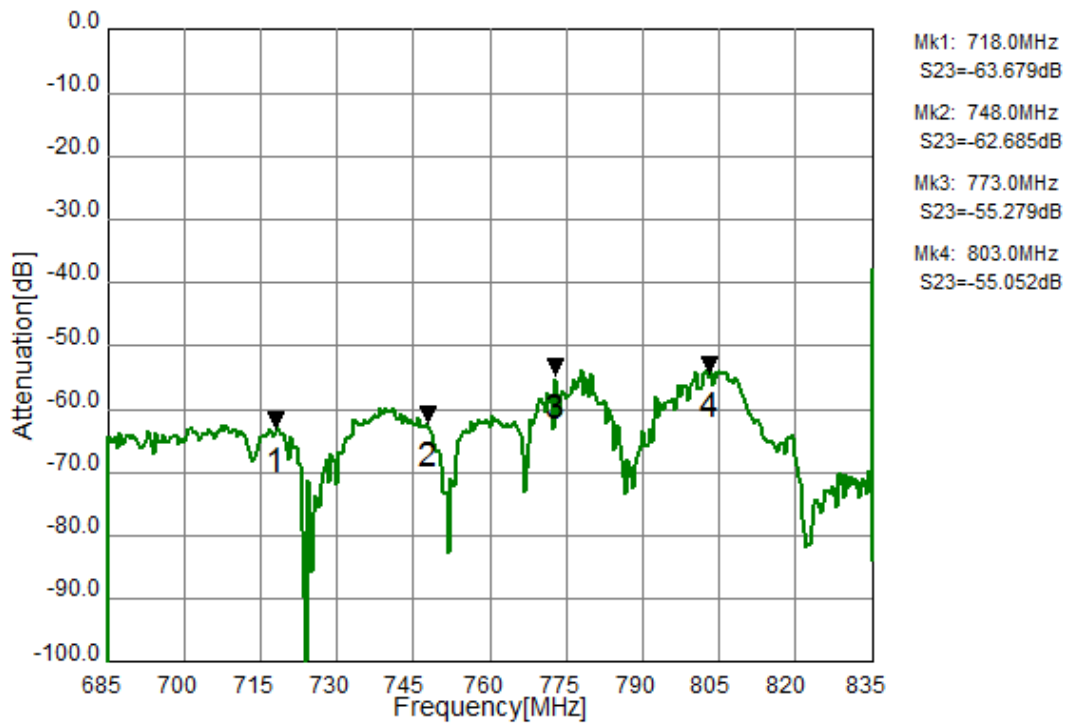

**Figure 3-2. Electrical Characteristics**

These data exclude loss that comes from the test board.



MSL1

\* Pb Free Part

Customer Name	Standard	TAIYO YUDEN Mobile Technology Co.,Ltd.	
System	Band 28 Block B Duplexer	Date	Apr. 4, 2014
Part Number	D5PF788M0M3Y9	Version 3.2ccB	Final

## Tx Port

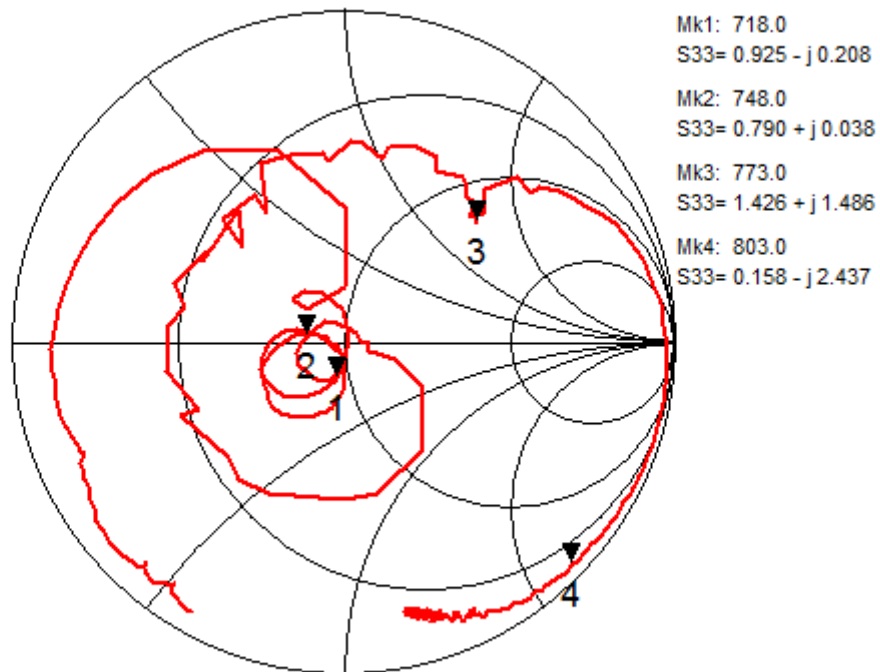
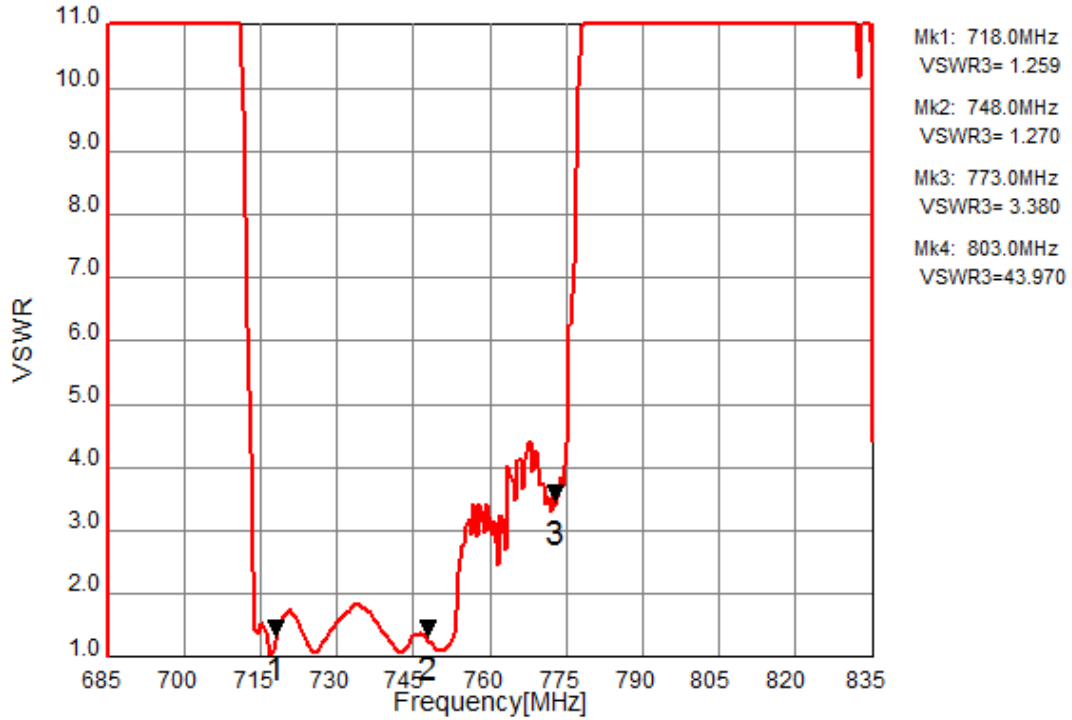

**Figure 3-3. Electrical Characteristics**



MSL1

\* Pb Free Part

Customer Name	Standard	TAIYO YUDEN Mobile Technology Co.,Ltd.	
System	Band 28 Block B Duplexer	Date	Apr. 4, 2014
Part Number	D5PF788M0M3Y9	Version 3.2ccB	Final

## Rx Port

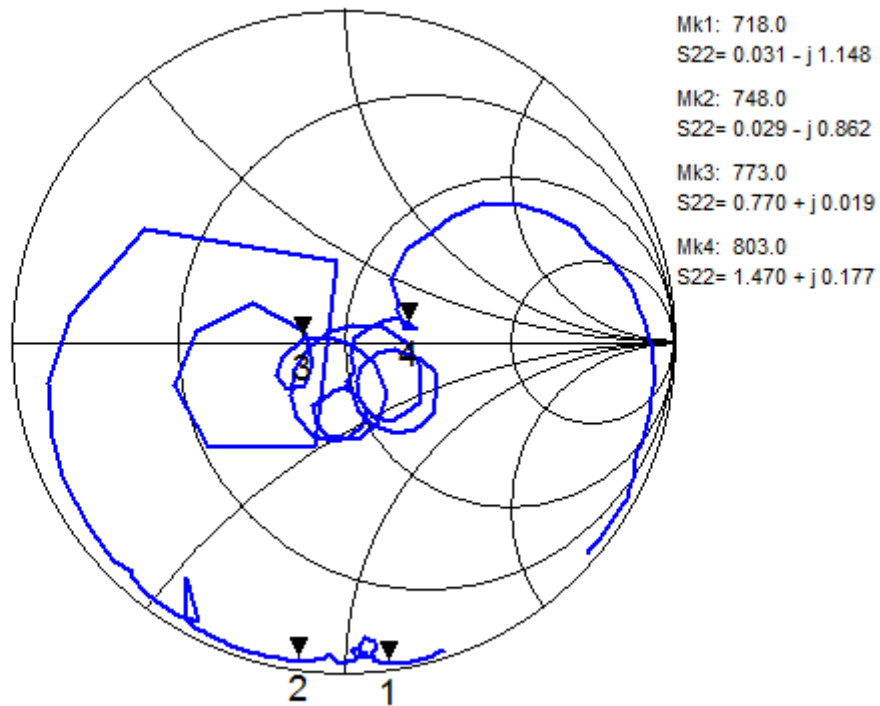
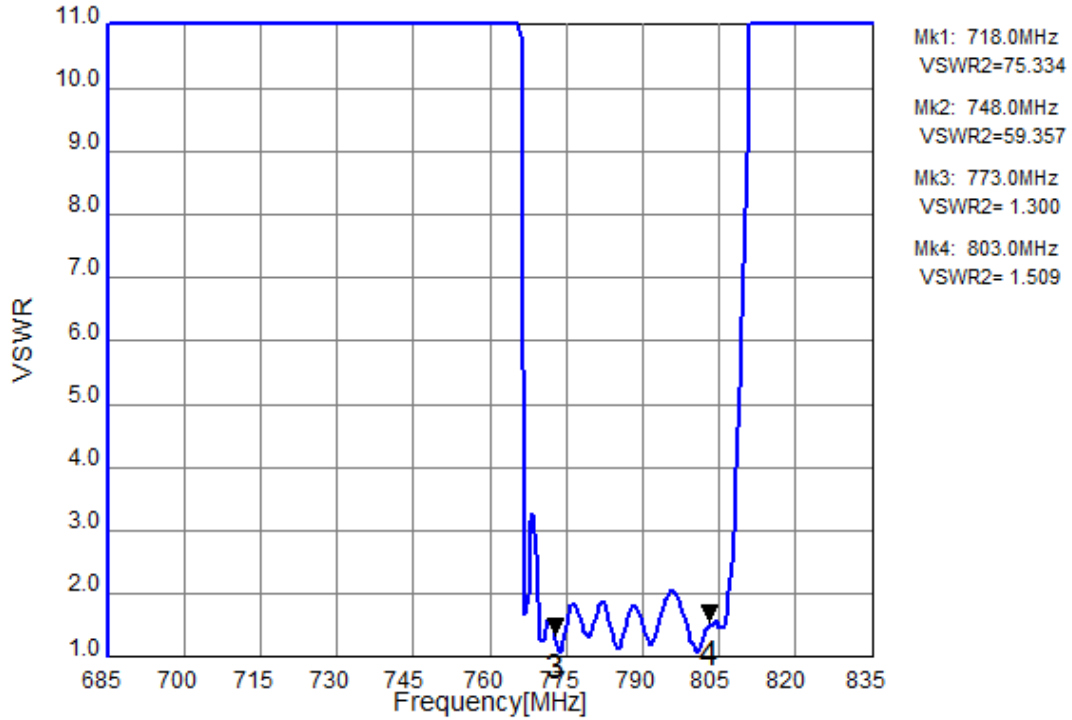

**Figure 3-4. Electrical Characteristics**





MSL1

\* Pb Free Part

Customer Name	Standard	TAIYO YUDEN Mobile Technology Co.,Ltd.	
System	Band 28 Block B Duplexer	Date	Apr. 4, 2014
Part Number	D5PF788M0M3Y9	Version 3.2ccB	Final

## Ant Port

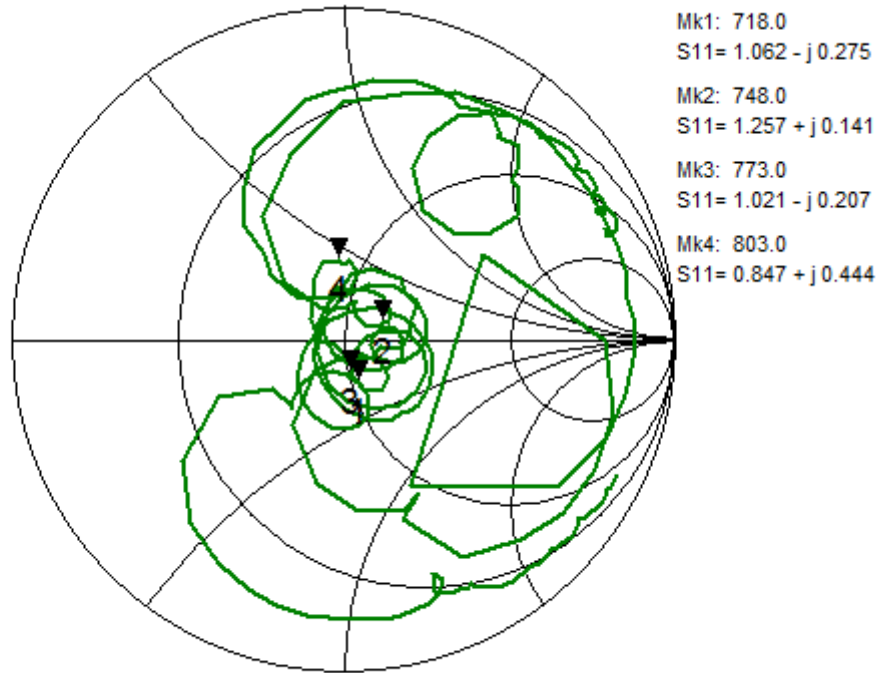
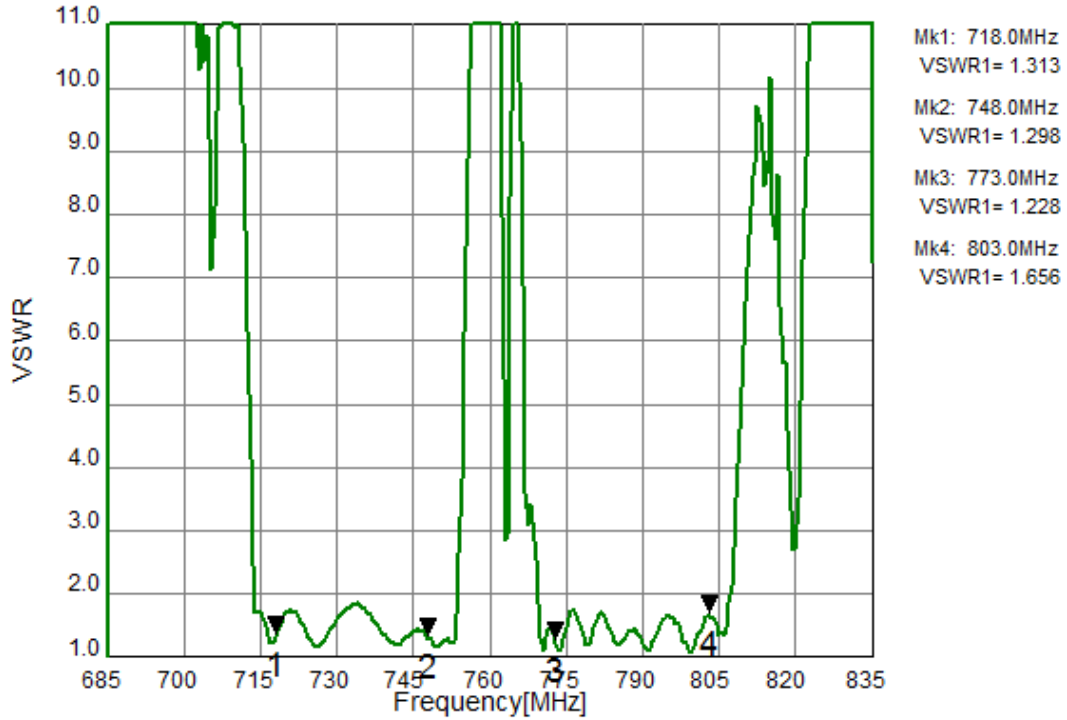

**Figure 3-5. Electrical Characteristics**



MSL1

\* Pb Free Part

Customer Name	Standard	TAIYO YUDEN Mobile Technology Co.,Ltd.	
System	Band 28 Block B Duplexer	Date	Apr. 4, 2014
Part Number	D5PF788M0M3Y9	Version 3.2ccB	Final

### Tx to Ant (Wide span)

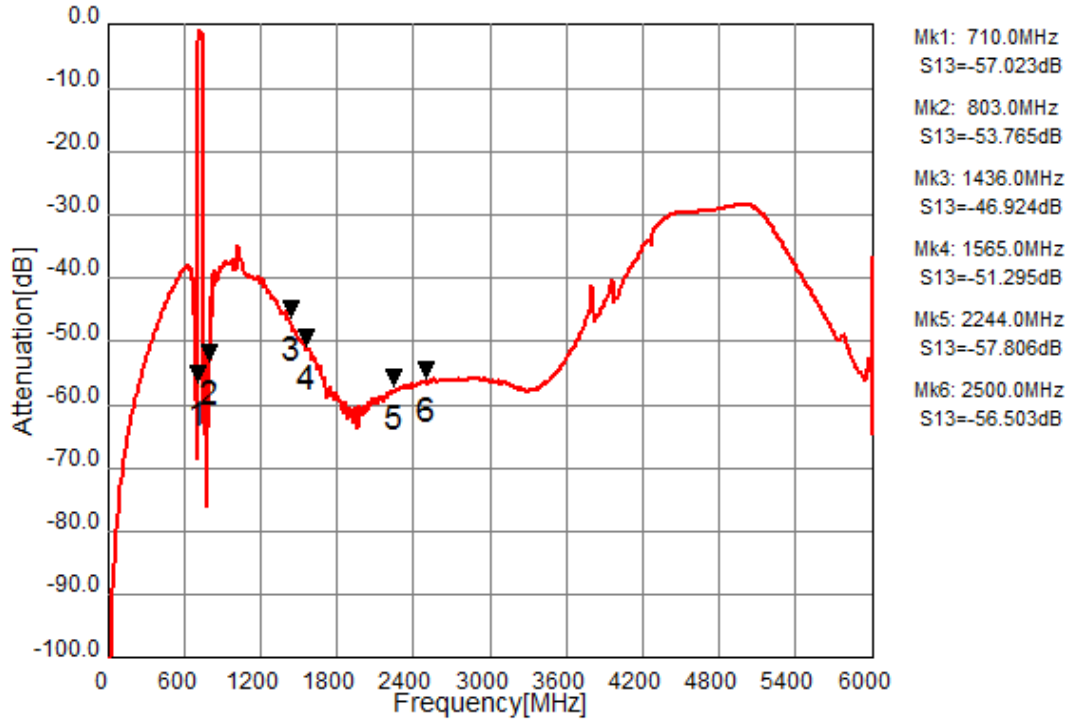

### Ant to Rx (Wide span)

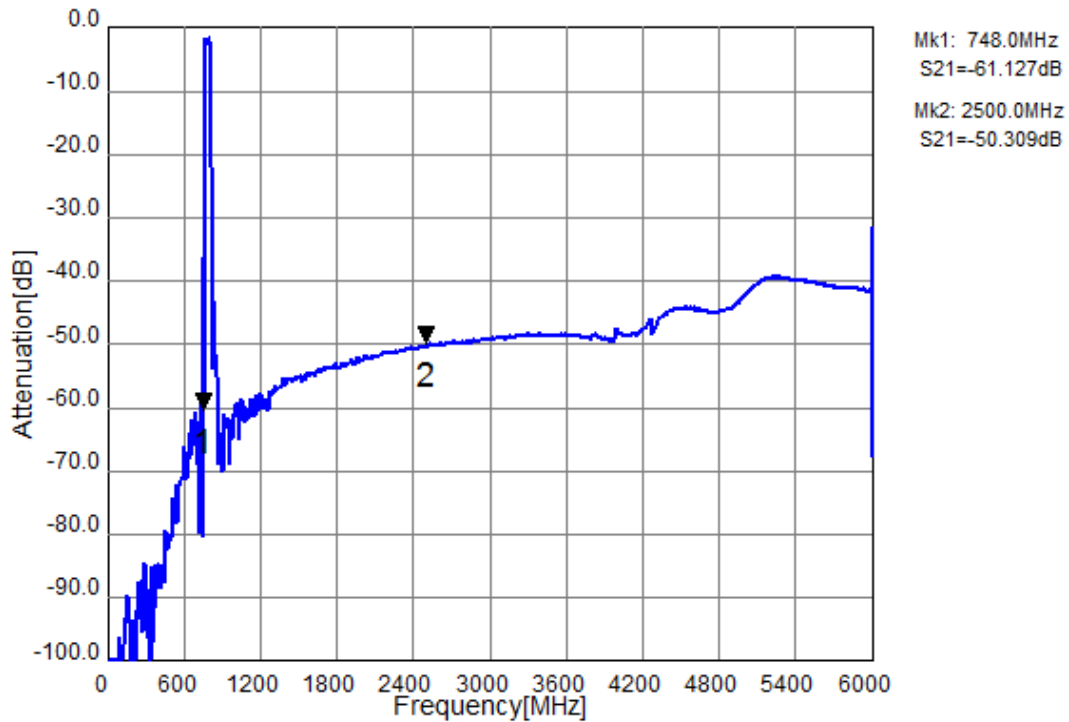

**Figure 3-6. Electrical Characteristics**



MSL1

\* Pb Free Part

Customer Name	Standard	TAIYO YUDEN Mobile Technology Co.,Ltd.	
System	Band 28 Block B Duplexer	Date	Apr. 4, 2014
Part Number	D5PF788M0M3Y9	Version 3.2ccB	Final

### Tx to Rx (Wide span)

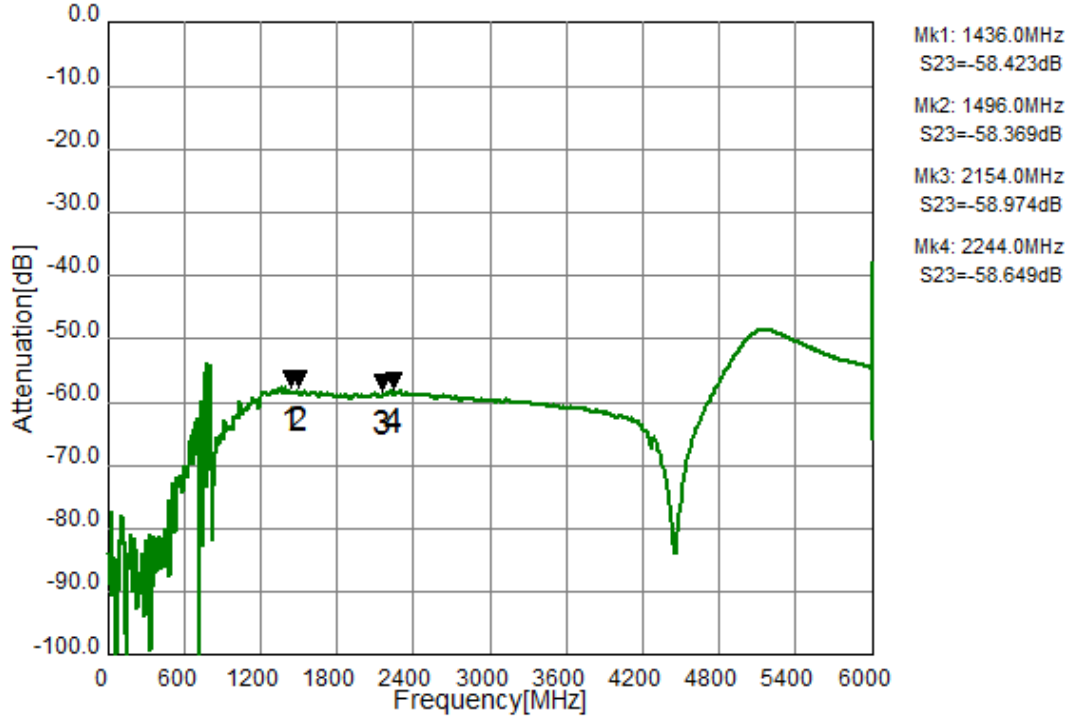

**Figure 3-7. Electrical Characteristics**



MSL1

\* Pb Free Part

Customer Name	Standard	TAIYO YUDEN Mobile Technology Co.,Ltd.	
System	Band 28 Block B Duplexer	Date	Apr. 4, 2014
Part Number	D5PF788M0M3Y9	Version 3.2ccB	Final

## Ordering Code

Ordering Code	Packing	Reel size	Status
D5PF788M0M3Y9-Z	Tape & Reel	3,000 pcs.	MP
D5PF788M0M3Y9-ZA	Tape & Reel	less than 3,000 pcs.	MP
D5PF788M0M3Y9-Y	Tape & Reel	15,000 pcs.	MP
D5PF788M0M3Y9-YA	Tape & Reel	less than 15,000 pcs.	MP
D5PF788M0M3Y9-Q	Bulk	few pcs.	MP

\*Minimum order quantity (MOQ) is assigned for each inquiry, Please contact to Sales Representatives..

\*MP : Mass Production

## Notice

All of the contents specified herein are subject to change without notice due to technical improvements, etc.

Please contact Taiyo Yuden Co., Ltd. for further details of product specifications.

Please conduct validation and verification of products in actual condition of mounting and operating environment before commercial shipment of the equipment.

This product is for general electronics equipment such as Audio-Visual equipment, household electronics, office supplies, information services and telecommunications; therefore, in case this product is used for any medical equipment, space equipment, nuclear equipment or disaster prevention equipment, please contact Taiyo Yuden in advance.

In case this product is used for general electronics equipment or circuits which require high safety and high reliability, thoroughly evaluate on safety and add a protection circuit if necessary.