

Applications

- Small Cell Base Station
- Microcell Base Station Driver
- Active Antenna
- General Purpose Applications

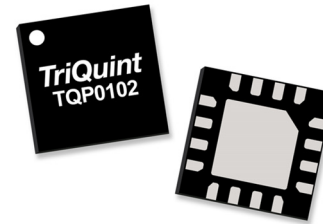

16 Pin 3x3mm QFN

Product Features

- Operating Frequency Range: DC to 4 GHz
- Output Power (P_{SAT}): 5 W
- Drain Efficiency: 68%
- Linear Gain: 19 dB
- Package Dimensions: 3 x 3 x 0.85 mm

Functional Block Diagram

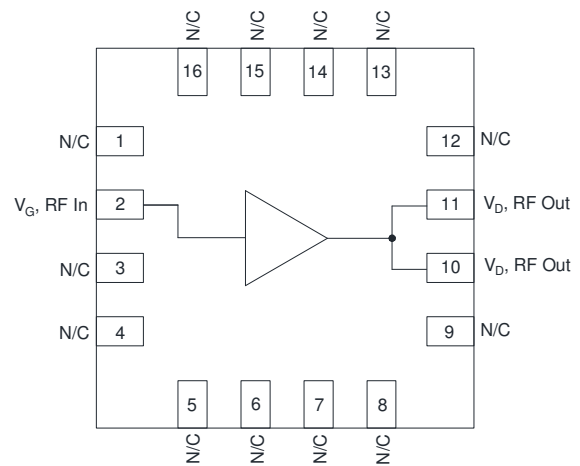

General Description

The TQP0102 is a wide band over-molded QFN discrete GaN power amplifier. The device is a single stage unmatched power amplifier transistor.

The TQP0102 can be used in Doherty architecture for the final stage of a base station power amplifier for small cell applications. The TQP0102 can also be used in microcell and active antenna applications.

The wide bandwidth of the TQP0102 makes it suitable for many different applications from DC to 4 GHz. TQP0102 can deliver P_{SAT} of 5 W at 28 to 32 V operation.

Lead-free and ROHS compliant.

Pin Configuration

Pin No.	Label
1, 3-9, 12-16	N/C
2	RF IN, V_G
10-11	RF OUT, V_D
Backside Paddle	RF/DC GND

Ordering Information

Part No.	ECCN	Description
TQP0102	EAR99	5 W, DC to 4 GHz, GaN PA
TQP0102-PCB	EAR99	2.5-2.7 GHz Evaluation Board

Absolute Maximum Ratings

Parameter	Rating
Gate Voltage (V_G)	-6 V
Drain Voltage (V_D)	+40 V
Peak RF Input Power	29 dBm
VSWR Mismatch, P1dB Pulse (20% duty cycle, 100 μ s width), T = 25°C	10:1
Storage Temperature	-65 to +150°C

Operation of this device outside the parameter ranges given above may cause permanent damage.

Recommended Operating Conditions

Parameter	Min	Typ	Max	Units
Operating Temperature	-40		+105	°C
Gate Voltage (V_G)		-2.9		V
Drain Voltage (V_D)		32		V
Quiescent Current (I_{CQ})		25		mA
T_{CH} for >10 ⁶ hours MTTF			225	°C

Electrical performance is measured under conditions noted in the electrical specifications table. Specifications are not guaranteed over all recommended operating conditions.

Electrical Specifications

Test conditions unless otherwise noted: $V_G = -2.67$ V, $V_D = 32$ V, $I_{CQ} = 25$ mA, T = 25°C, 2.6 GHz single-ended application circuit

Parameter	Conditions	Min	Typ	Max	Units
Frequency Range		DC		4000	MHz
Quiescent Current		20	25	30	mA
Linear Gain	$P_{OUT} = 25$ dBm, Pulsed (10% duty cycle, 100 μ s width)	17	19		dB
P3dB	Pulsed (10% duty cycle, 100 μ s width)	36.5	37		dBm
Drain Efficiency	P3dB	60	65		%
Input Return Loss	Measured in EVB		10		dB

Thermal Information

Parameter	Conditions	Value	Units
Thermal Resistance at Average Power (θ_{JC})	$T_C = 85^\circ\text{C}$, $T_{CH} = 114.1^\circ\text{C}$, CW: $P_{DISS} = 1.59\text{ W}$, $P_{OUT} = 0.35\text{ W}$	18.3	$^\circ\text{C/W}$
Thermal Resistance at Saturated Power (θ_{JC})	$T_C = 85^\circ\text{C}$, $T_{CH} = 135.1^\circ\text{C}$, CW: $P_{DISS} = 2.65\text{ W}$, $P_{OUT} = 5.59\text{ W}$	18.9	$^\circ\text{C/W}$

Notes:

1. Thermal resistance measured to package backside.

Median Lifetime

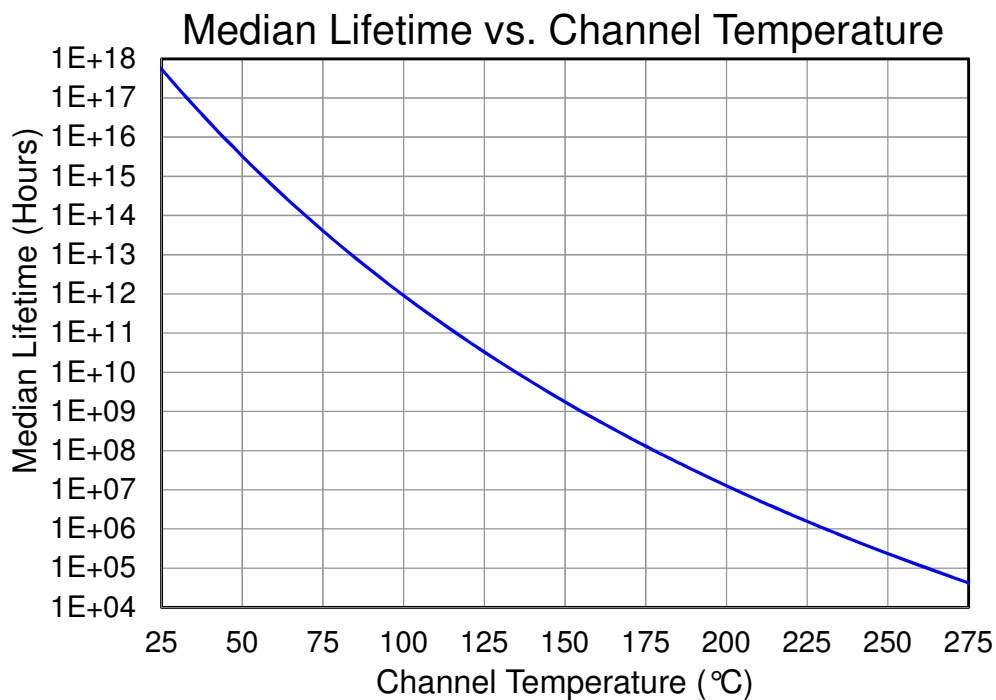

Evaluation Board Layout

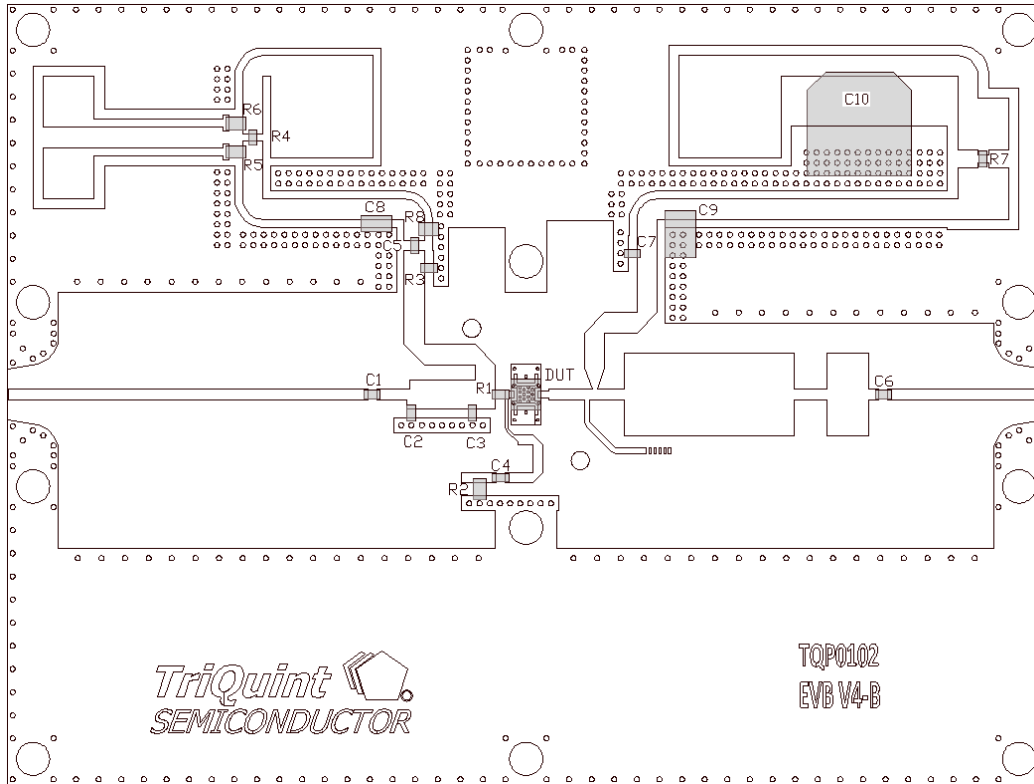

Bill of Materials

Reference Des.	Value	Description	Manuf.	Part Number
C1, C4, C5, C6, C7	22 pF	Capacitor, 0603	ATC	600S220BT250XT
C2, C3	0.7 pF	Capacitor, 0.5 pF, 0603	ATC	600S005BT250XT
C8	10 μ F	Capacitor, 6.3 V, 0612	TDK	C1632X5R0J106M130AC
C9	1 μ F	Capacitor, 1812	AVX	18121C105KAT2A
C10	220 μ F	Capacitor, 10x10 mm, 50 V	United Chem Con	EMVY500ADA221MJA0G
R1	2.5 Ω	Resistor, 2.5 Ω , 0603	Venkel	CR0603
R2	75 Ω	Resistor, 75 Ω , 0805	Venkel	CR0805
R3	10 Ω	Resistor, 1/10 W 1% 0603	Venkel	ERJ-3EKF10R0V
R8	1 k Ω	Resistor, 0805	Venkel	RES 1k OHM 0805
R3, R4	10 Ω	Resistor, 1/10 W 1% 0603	Venkel	ERJ-3EKF10R0V
R5, R6			DNP	
R7			DNP	

Performance Plots

Test conditions unless otherwise noted: $V_D = 32\text{ V}$, $I_{CO} = 25\text{ mA}$, $T = 25^\circ\text{C}$, 2.6 GHz single-ended application circuit

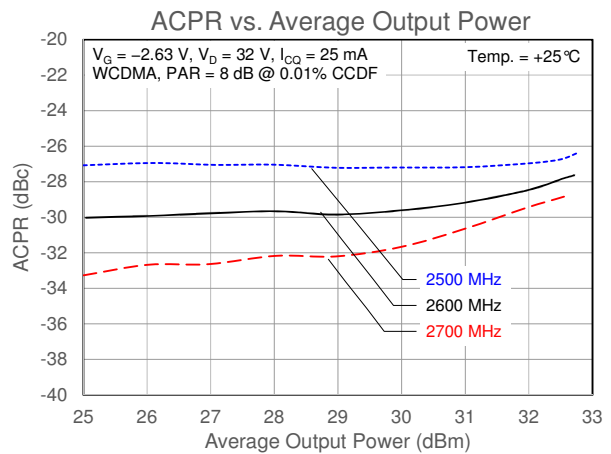
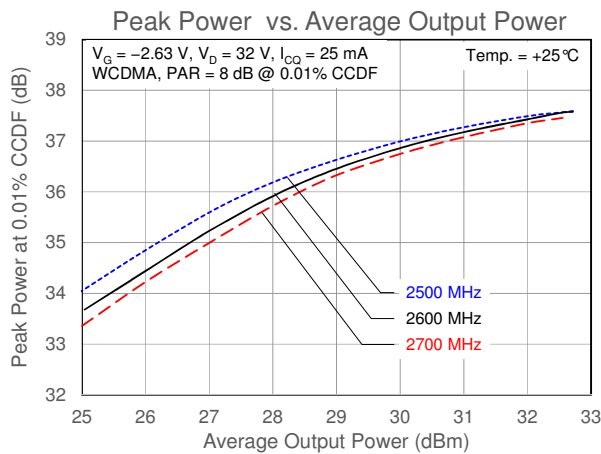
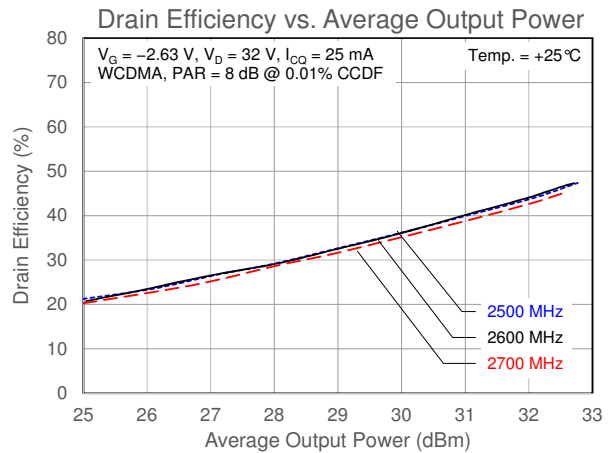
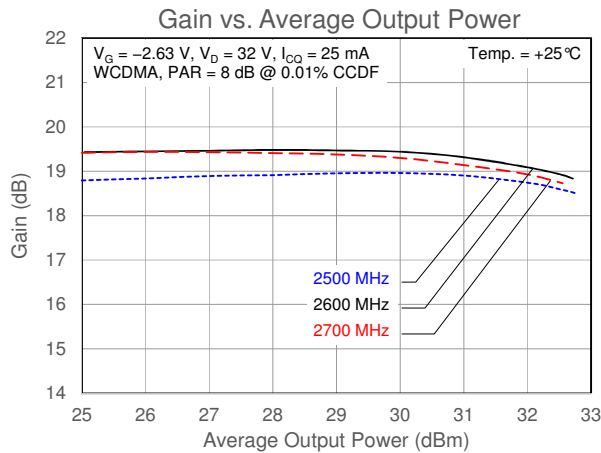
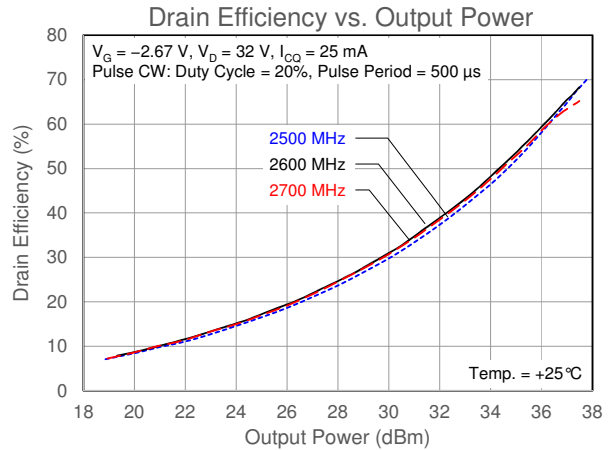
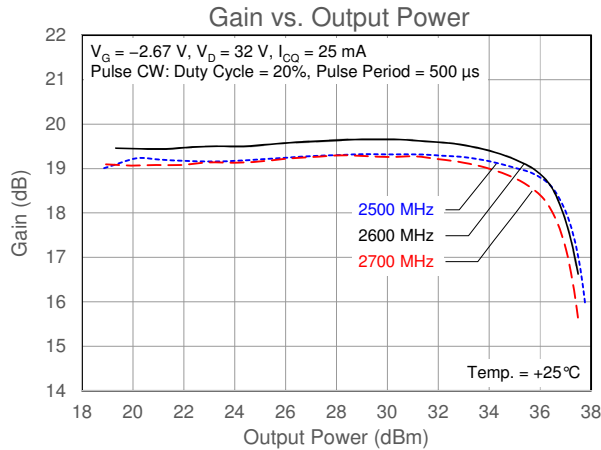

Performance Plots

Test conditions unless otherwise noted: $V_D = 32\text{ V}$, $I_{CQ} = 25\text{ mA}$, $T = 25^\circ\text{C}$, 2.6 GHz single-ended application circuit

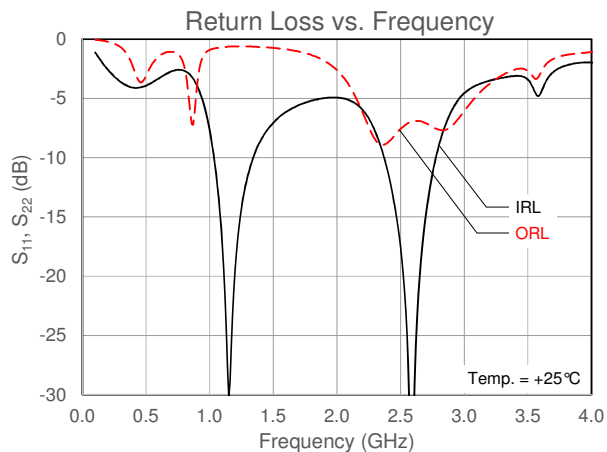
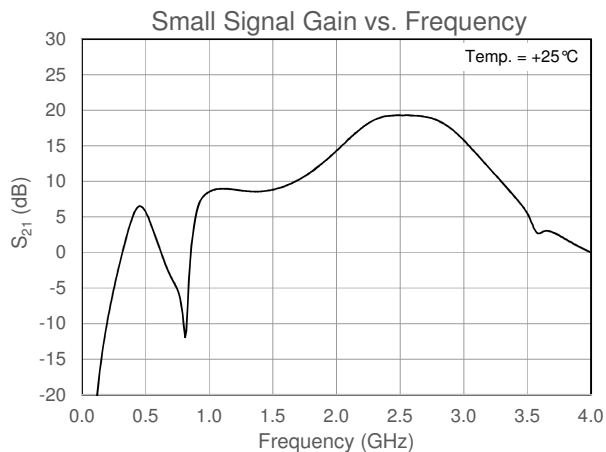

Load Pull Plots

Test conditions unless otherwise noted: $V_D = 32$ V, $I_{CQ} = 25$ mA, $T = 25^\circ\text{C}$, Pulse CW (duty cycle = 20%, pulse period = 500 μs)

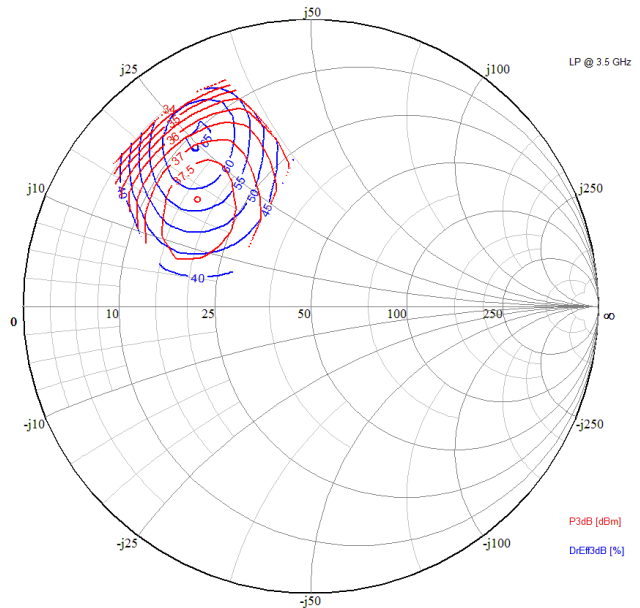
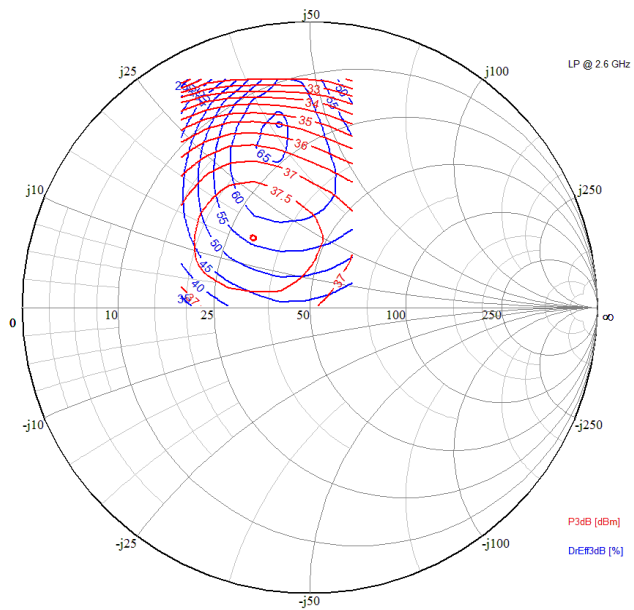
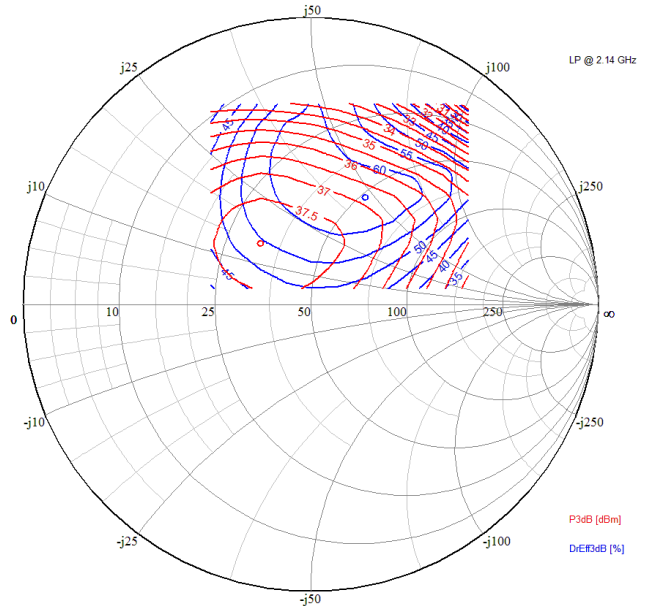
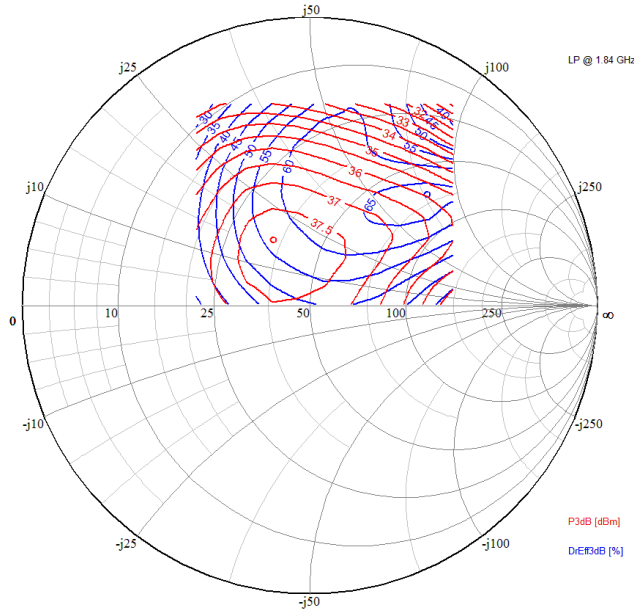

Pin Configuration and Description

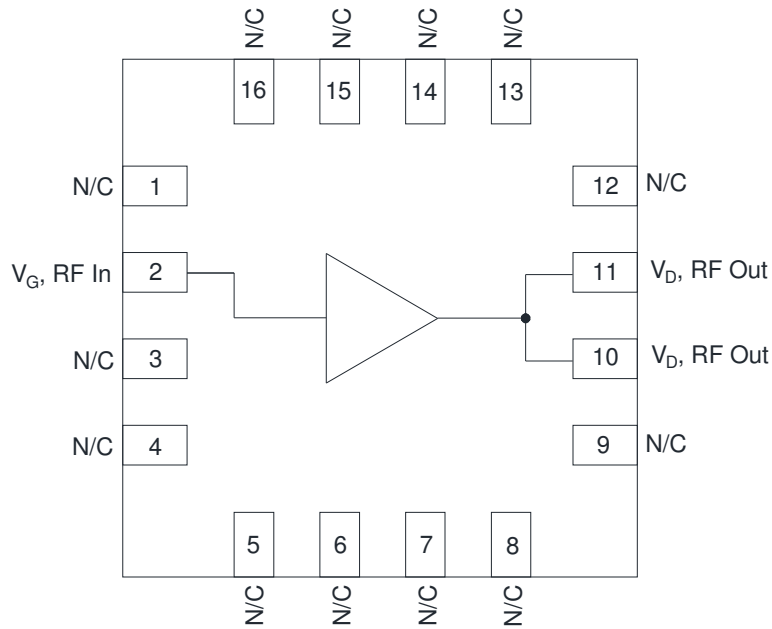

Pin No.	Label	Description
1, 3, 4, 5, 6, 7, 8, 9, 12, 13, 14, 15, 16	N/C	No Connection
2	RF IN, V_G	RF Input, Gate Bias
10, 11	RF OUT, V_D	RF Output, Drain Bias
Backside Paddle	RF/DC GND	RF/DC Ground

Package Marking and Dimensions

Marking: Part ID – 0102
 Year/Workweek – YYWW
 "M" + Lot Number – MZZZ

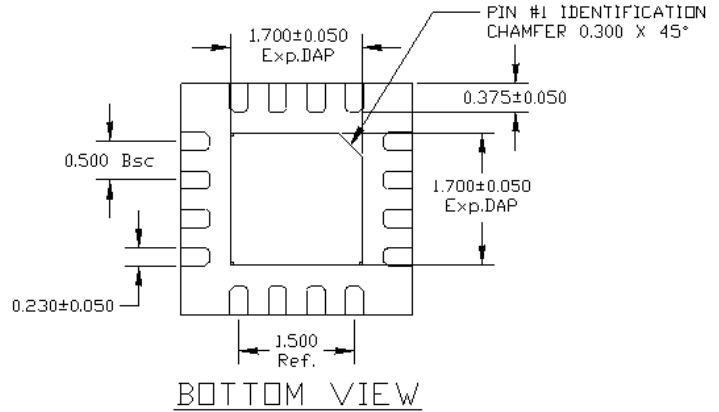
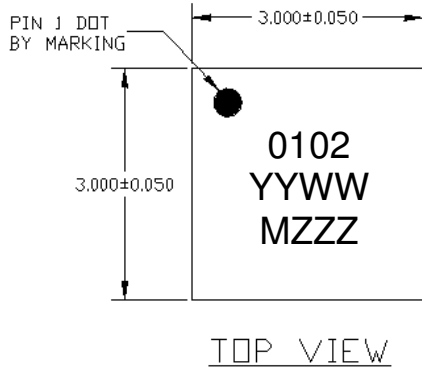

A		QFN
MAX.		0.900
NOM.		0.650
MIN.		0.800

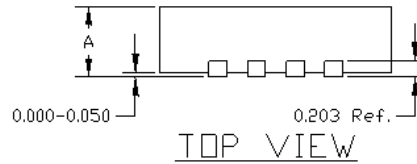

Notes:
 1. All dimensions are in millimeters. Angles are in degrees.

PCB Mounting Pattern

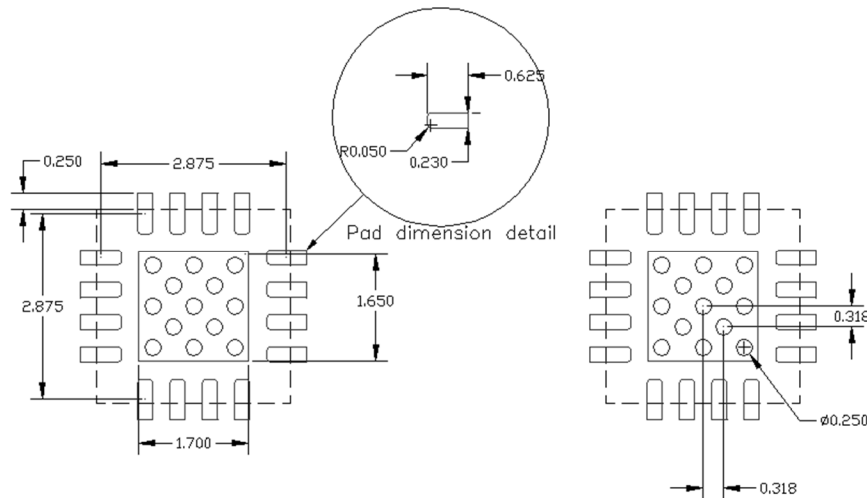

Notes:
 1. All dimensions are in millimeters. Angles are in degrees.

Product Compliance Information

ESD Sensitivity Ratings



Caution! ESD-Sensitive Device

ESD Rating: Class 1A
Value: Passes \geq 250 V
Test: Human Body Model (HBM)
Standard: JEDEC Standard JS-001-2012

ESD Rating: Class C3
Value: Passes \geq 1000 V
Test: Charged Device Model (CDM)
Standard: JEDEC Standard JESD22-C101F

MSL Rating

MSL Rating: Level 3
Test: 260°C convection reflow
Standard: JEDEC Standard IPC/JEDEC J-STD-020D.1

ECCN

US Department of Commerce EAR99

Solderability

Compatible with both lead-free (260°C maximum reflow temperature) and tin/lead (245°C maximum reflow temperature) soldering processes.

Contact plating: NiPdAu

RoHS Compliance

This part is compliant with EU 2002/95/EC RoHS directive (Restrictions on the Use of Certain Hazardous Substances in Electrical and Electronic Equipment).

This product also has the following attributes:

- Lead Free
- Halogen Free (Chlorine, Bromine)
- Antimony Free
- TBBP-A (C₁₅H₁₂Br₄O₂) Free
- PFOS Free
- SVHC Free

Contact Information

For the latest specifications, additional product information, worldwide sales and distribution locations, and information about TriQuint:

Web: www.triquint.com
Email: info-sales@triquint.com

Tel: +1.972.994.8465
Fax: +1.972.994.8504

For technical questions and application information: Email: btsapplications@tqs.com

Important Notice

The information contained herein is believed to be reliable. TriQuint makes no warranties regarding the information contained herein. TriQuint assumes no responsibility or liability whatsoever for any of the information contained herein. TriQuint assumes no responsibility or liability whatsoever for the use of the information contained herein. The information contained herein is provided "AS IS, WHERE IS" and with all faults, and the entire risk associated with such information is entirely with the user. All information contained herein is subject to change without notice. Customers should obtain and verify the latest relevant information before placing orders for TriQuint products. The information contained herein or any use of such information does not grant, explicitly or implicitly, to any party any patent rights, licenses, or any other intellectual property rights, whether with regard to such information itself or anything described by such information.

TriQuint products are not warranted or authorized for use as critical components in medical, life-saving, or life-sustaining applications, or other applications where a failure would reasonably be expected to cause severe personal injury or death.