

LAYOUT FOR P.C.B

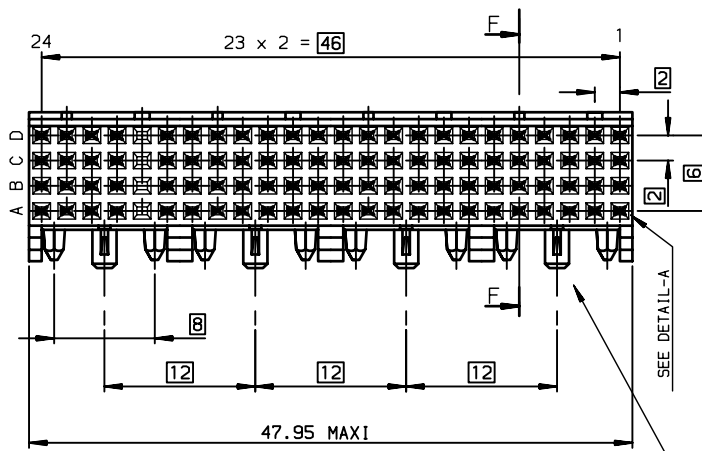

DETAIL OF PRESS-IN PEGS

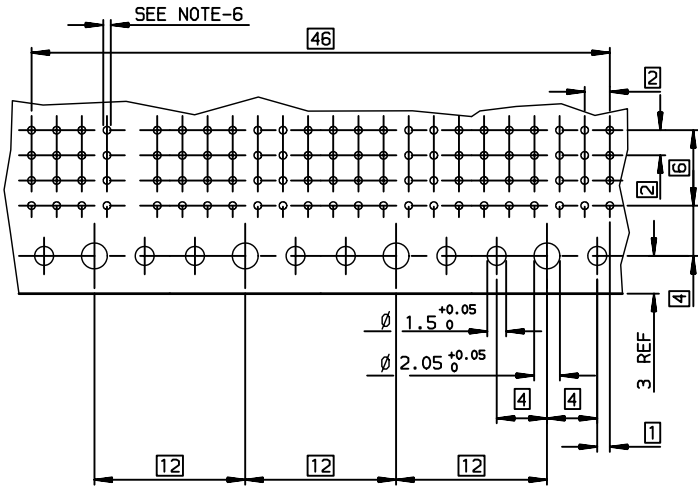
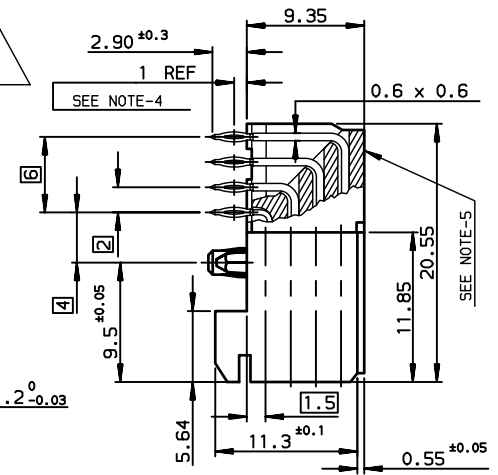
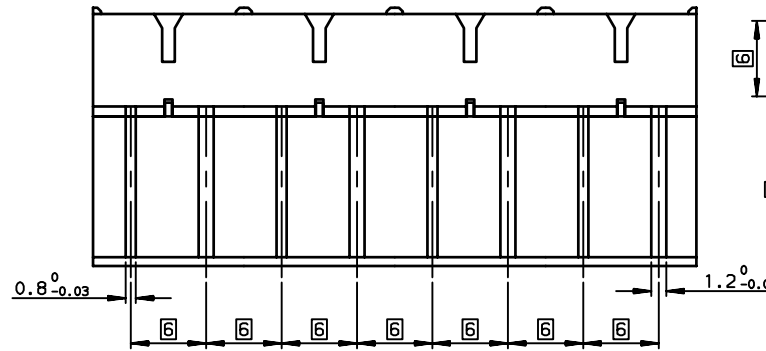
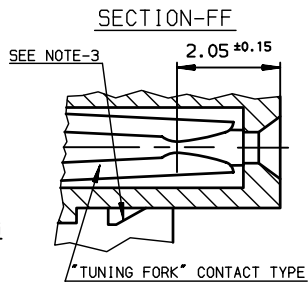
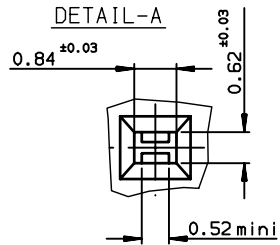
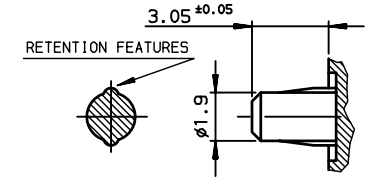

TIN LEAD PART NUMBER

Part number **HM1F43FDP270H6**

LEAD FREE PART NUMBER

Part number **HM1F43FDP270H6LF**

NOTE-1: PRESS-IN RETENTION PEG

NOTE-2: CONNECTORS WITH PCB-2.4mm ARE COMPATIBLE WITH WIDE AND NARROW BODIES

NOTE-3: PLUG FOR CODING KEY FIXING

NOTE-4: EYE OF THE NEEDLE PRESS-FIT CTS TYPE

NOTE-5: FLAT ROCK INSERTION TOOLING IN PCB, SEE DRW REF:C-8626-1003

NOTE-6: METALIZED HOLE DEFINITION,SEE GS-12-447

NOTE-7: STANDARD PACKAGING IS IN TUBE ,BUT IF SUFFIX "P" IS ADDED IN P/N ,PACKAGING IS IN TRAYS ,BUT CONNECTOR MARKING IS WITHOUT "P"
Example: HM1FxxxxxxxH6PLF, marking: HM1FxxxxxxxH6LF

SPECIFIC DATAS

EMPTY CAVITIES

- A: 20
- B: 20
- C: 20
- D: 20

rev	ecn no	dr	date
A	-	-	1998/05/06
B	LS05-004	MLE	2005/02/19
C	LS06-0095	LGO	2006/07/14
D	LS06-0159	MLE	2006/10/31
E	LS07-0266	MLE	2007/11/08
-	-	-	-
-	-	-	-

GENERAL CHARACTERISTICS AND ROHS INFORMATIONS:

SEE GS-12-447

European Views

www.fciconnect.com		surface ISO 1302 ✓	tolerance std ISO 406 ISO 1101	projection mm
TOLERANCES UNLESS OTHERWISE SPECIFIED				
Dr	ETIEMBRE	1998/05/06	0.X	±0.1
Eng	LENOIR	1998/05/06	0.XX	±0.1
Chr	LEGARE	1998/05/06	0.XXX	±0.1
Appr	LEGARE	1998/05/06	size A3 Scale 2.5	
Product family			METRAL Spec ref -	
title		METRAL FEMALE 4 ROW 92 CTS		
catalog no		RIGHT ANGLE PRESS-FIT/PRESS-IN PEG		
dwg no		C-8626-0900		
customer		sheet 1 of 1		