

MZ OPTICAL MODULATOR DRIVER, DC - 20 GHz



Typical Applications

The HMC870LC5 is ideal for:

- 10 Gbps NRZ MZ & Low V_{π} Modulator Driver
- 10 Gbps RZ Transmission
- 40 Gbps DQPSK
- Broadband Gain Block for Test & Measurement Equipment
- Military & Space

Features

- Wide Supply Range from 3.3V to 7V
- Adjustable Output Amplitude: 2.5 to 8 Vp-p
- Low Additive RMS Jitter, <300 fs
- Low DC Power Consumption
1W for $V_{out} = 8$ Vp-p at $V_{dd} = 7V$
- Cross Point Adjustment
- 32 Lead 5x5mm SMT Package: 25mm²

Functional Diagram

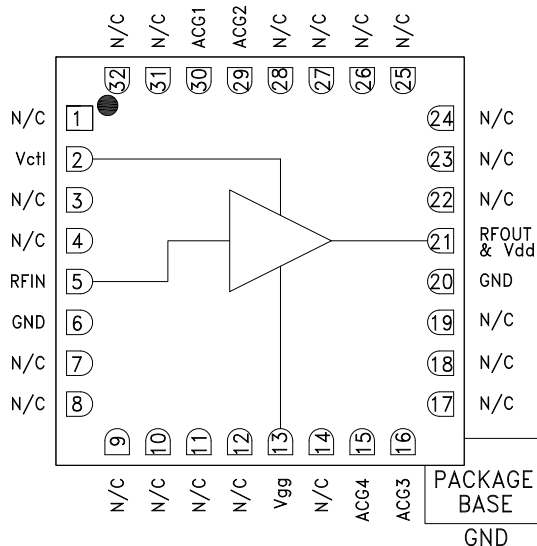

General Description

The HMC870LC5 is a GaAs MMIC pHEMT Distributed Driver Amplifier packaged in a leadless 5x5 mm surface mount package which operates between DC and 20 GHz. The amplifier provides 17 dB of gain, 8Vp-p saturated output swing and features output swing cross point adjustment. Gain flatness is excellent at ± 0.5 dB as well as very low additive RMS jitter of 300 fs for 10 Gbps operation. HMC870LC5 provides Metro and Long Haul designers with scalable power dissipation for varying output drive requirements. (<0.4W at $V_{out} = 3.6$ Vp-p and <1W at $V_{out} = 8.5$ Vp-p) The HMC870LC5 has a very wide supply (V_{dd}) operating range from +3.3V to +7V, and the RF I/Os are internally matched to 50 Ohms.

Electrical Specifications, $T_A = +25^\circ C$, $V_{dd} = 7V$, $V_{ctl} = 1V$, $I_{dd} = 165mA^*$

| Parameter | Conditions | Min. | Typ. | Max. | Units |
|--------------------------------------|-------------------------|------|----------|-------|----------------|
| Gain | Frequency = 1 - 8 GHz | 14 | 17.5 | | dB |
| | Frequency = 8 - 16 GHz | 13 | 16.5 | | dB |
| | Frequency = 16 - 20 GHz | 12 | 16 | | dB |
| Small Signal Bandwidth | 3-dB cutoff | | 20 | | GHz |
| Input Return Loss | Frequency = 1 - 10 GHz | | 20 | | dB |
| | Frequency = 10 - 20 GHz | | 15 | | dB |
| Output Return Loss | Frequency = 1 - 10 GHz | | 20 | | dB |
| | Frequency = 10 - 20 GHz | | 15 | | dB |
| Gain Variation over Temperature | Frequency = 1 - 10 GHz | | 0.015 | 0.02 | dB/ $^\circ C$ |
| | Frequency = 10 - 20 GHz | | 0.032 | 0.045 | dB/ $^\circ C$ |
| Group Delay Variation | Frequency = 1 - 12 GHz | | ± 15 | | ps |
| Saturated Output Power (P_{sat}) | Frequency = 1 - 12 GHz | | 24 | | dBm |
| | Frequency = 12 - 20 GHz | | 23 | | dBm |

* Adjust V_{gg} between -2V to 0V to achieve $I_{dd} = 165$ mA typical.



MZ OPTICAL MODULATOR DRIVER, DC - 20 GHz

Electrical Specifications, $T_A = +25^\circ\text{C}$, $V_{dd} = 7\text{V}$, $V_{ctl} = 1\text{V}$, $I_{dd} = 165\text{mA}^*$ Continued

| Parameter | Conditions | Min. | Typ. | Max. | Units |
|--|-------------------------|------|------|------|-------|
| Output Power for 1 dB Compression (P1dB) | Frequency = 1 - 12 GHz | 19 | 22 | | dBm |
| | Frequency = 12 - 20 GHz | 18 | 21 | | dBm |
| Rise Time [1] | 20% - 80% | | 20 | | ps |
| Fall Time [1] | 20% - 80% | | 20 | | ps |
| Additive RMS Jitter [2] | | | | 300 | fs |
| Supply Current (I _{dd}) (V _{gg} = -0.6V Typ.) | | | 165 | | mA |
| Bias Current Adjust (V _{gg}) | | -2 | | 0 | V |
| Output Voltage Adjust (V _{ctl}) | | 0 | | 2 | V |

[1] Data input = 22.5 Gbps NRZ PRBS 2²³-1 pattern, 1.2 V_{p-p}.

[2] RMS jitter is calculated with 22.5 Gbps 10101... pattern.

* Adjust V_{gg} between -2V to 0V to achieve I_{dd} = 165 mA typical.

Electrical Specifications, $T_A = +25^\circ\text{C}$, $V_{dd} = 5\text{V}$, $V_{ctl} = 1\text{V}$, $I_{dd} = 140\text{mA}^*$

| Parameter | Conditions | Min. | Typ. | Max. | Units |
|--|-------------------------|------|-------|-------|-------|
| Gain | Frequency = 1 - 8 GHz | 14 | 17.5 | | dB |
| | Frequency = 8 - 16 GHz | 13.5 | 17.0 | | dB |
| | Frequency = 16 - 20 GHz | 12 | 16.5 | | dB |
| Small Signal Bandwidth | 3-dB cutoff | | 20 | | GHz |
| Input Return Loss | Frequency = 1 - 10 GHz | | 20 | | dB |
| | Frequency = 10 - 20 GHz | | 15 | | dB |
| Output Return Loss | Frequency = 1 - 10 GHz | | 15 | | dB |
| | Frequency = 10 - 20 GHz | | 10 | | dB |
| Gain Variation over Temperature | Frequency = 1 - 10 GHz | | 0.016 | 0.02 | dB/°C |
| | Frequency = 10 - 20 GHz | | 0.029 | 0.045 | dB/°C |
| Group Delay Variation | Frequency = 1 - 12 GHz | | ±15 | | deg |
| Saturated Output Power (P _{sat}) | Frequency = 1 - 12 GHz | | 22.5 | | dBm |
| | Frequency = 12 - 20 GHz | | 22 | | dBm |
| Output Power for 1 dB Compression (P1dB) | Frequency = 1 - 12 GHz | 18 | 20.5 | | dBm |
| | Frequency = 12 - 20 GHz | 17 | 20 | | dBm |
| Rise Time [1] | 20% - 80% | | 20 | | ps |
| Fall Time [1] | 20% - 80% | | 20 | | ps |
| Additive RMS Jitter [2] | | | | 300 | fs |
| Supply Current (I _{dd}) (V _{gg} = -0.6V Typ.) | | | 140 | | mA |
| Bias Current Adjust (V _{gg}) | | -2 | | 0 | V |
| Output Voltage Adjust (V _{ctl}) | | 0 | | 2 | V |

[1] Data input = 22.5 Gbps NRZ PRBS 2²³-1 pattern, 1.2 V_{p-p}.

[2] RMS jitter is calculated with 22.5 Gbps 10101... pattern.

* Adjust V_{gg} between -2V to 0V to achieve I_{dd} = 140 mA typical.



**MZ OPTICAL MODULATOR
DRIVER, DC - 20 GHz**

Gain & Return Loss @ Vdd = 7V

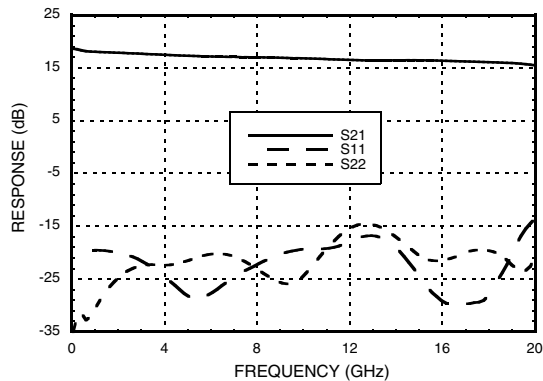

Gain & Return Loss @ Vdd = 5V

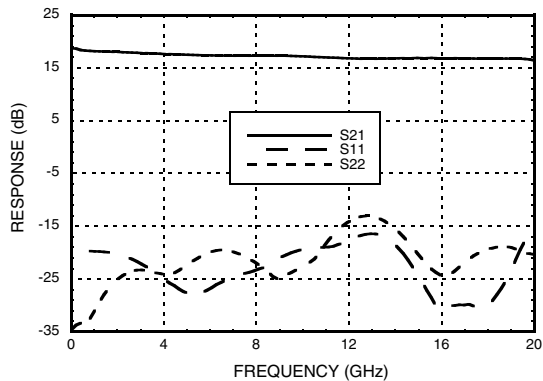

Gain & Return Loss @ Vdd = 3.3V

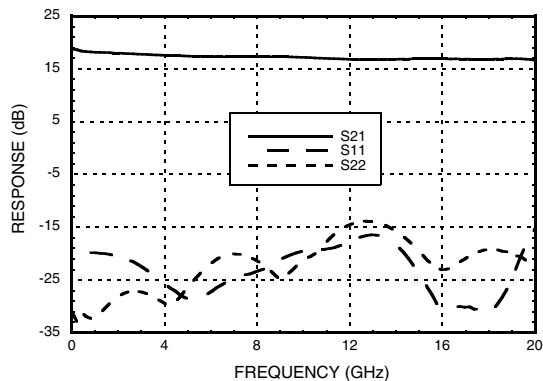

Gain vs. Temperature @ Vdd = 7V

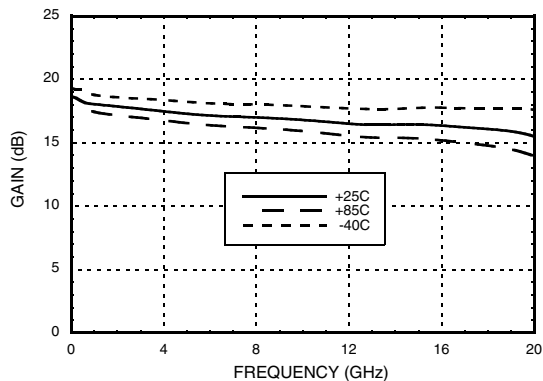

Gain vs. Temperature @ Vdd = 5V

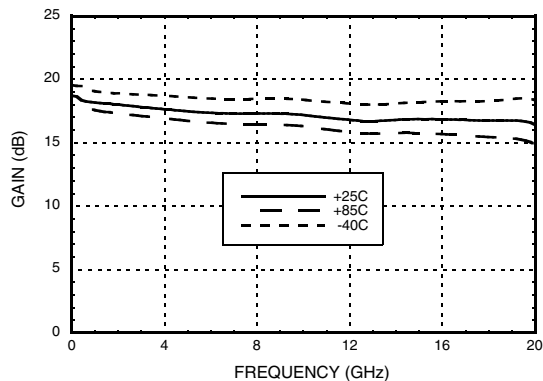

Gain vs. Temperature @ Vdd = 3.3V

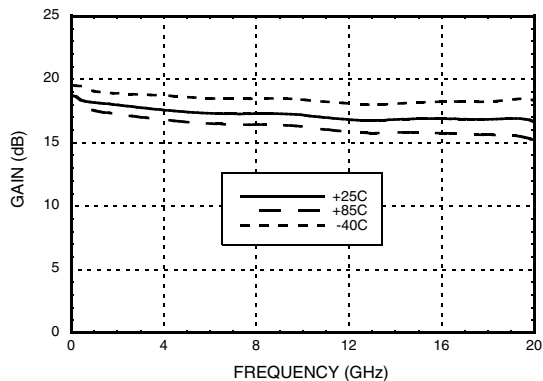

Information furnished by Analog Devices is believed to be accurate and reliable. However, no responsibility is assumed by Analog Devices for its use, nor for any infringements of patents or other rights of third parties that may result from its use. Specifications subject to change without notice. No license is granted by implication or otherwise under any patent or patent rights of Analog Devices. Trademarks and registered trademarks are the property of their respective owners.

For price, delivery, and to place orders: Analog Devices, Inc., One Technology Way, P.O. Box 9106, Norwood, MA 02062-9106 Phone: 781-329-4700 • Order online at www.analog.com Application Support: Phone: 1-800-ANALOG-D



MZ OPTICAL MODULATOR DRIVER, DC - 20 GHz

P1dB vs. Temperature @ Vdd = 7V

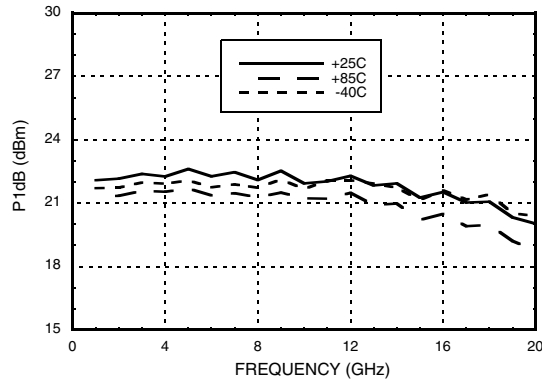

Psat vs. Temperature @ Vdd = 7V

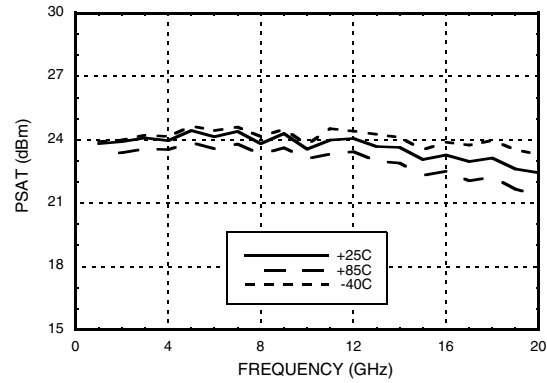

Output Power vs. Input Power @ 10 GHz, Vdd = 7V

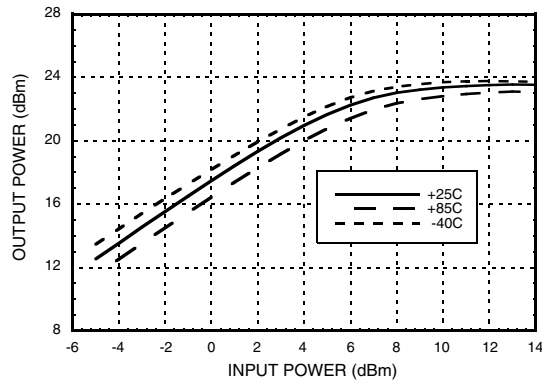

Output Power vs. Input Power @ 10 GHz, Vdd = 5V

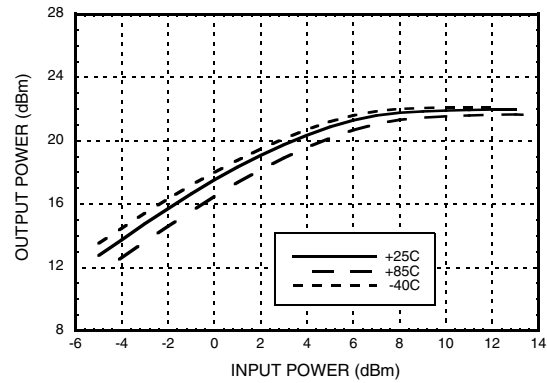

Output Power vs. Input Power @ 10 GHz, Vdd = 3.3V

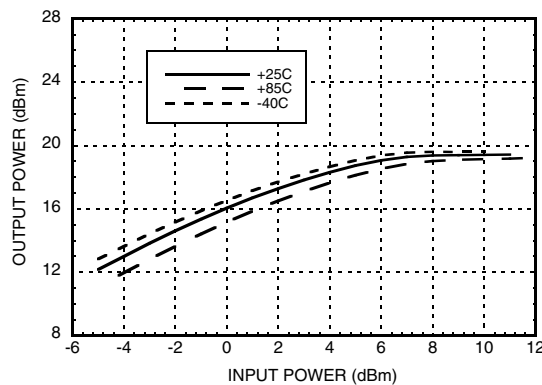

Peak-to-Peak Output Voltage vs. Vdd @ 11.25 Gbps [1]

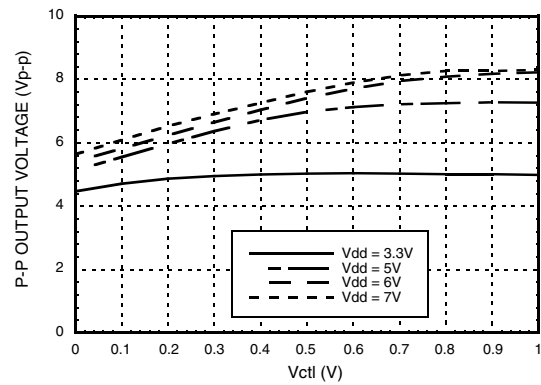

[1] Data input = 11.25 Gbps NRZ PRBS 2²³-1 pattern, 1.2 Vp-p.

**MZ OPTICAL MODULATOR
DRIVER, DC - 20 GHz**



Peak-to-Peak Output Voltage vs. Vdd @ 22.5 Gbps [1]

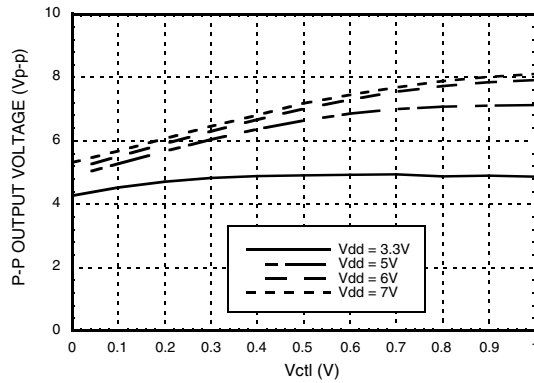

Rise Time vs. Vdd @ 22.5 Gbps [1]



Fall Time vs. Vdd @ 22.5 Gbps [1]

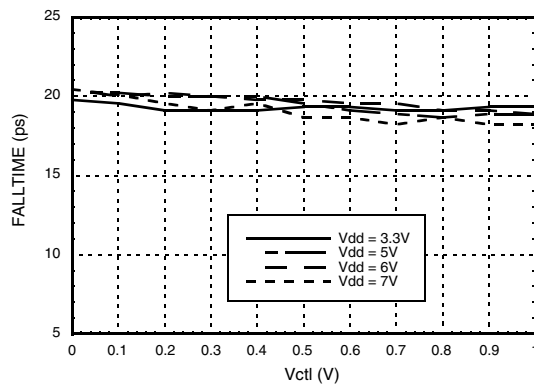

RMS Jitter vs. Vdd @ 22.5 Gbps [2]



Peak-to-Peak Jitter vs. Vdd @ 11.25 Gbps [3][4]

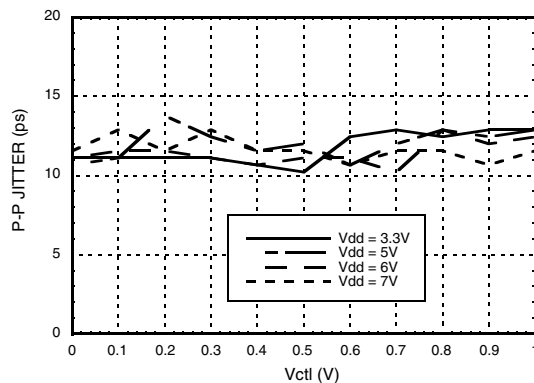

Peak-to-Peak Jitter vs. Vdd @ 22.5 Gbps [1][4]



[1] Data input = 22.5 Gbps NRZ PRBS 2²³-1 pattern, 1.2 Vp-p.

[2] RMS jitter is measured with 22.5 Gbps 10101... pattern.

[3] Data input = 11.25 Gbps NRZ PRBS 2²³-1 pattern, 1.2 Vp-p.

[4] Source jitter was not de-embedded.



**MZ OPTICAL MODULATOR
DRIVER, DC - 20 GHz**

Supply Current vs. Vdd @ 22.5 Gbps [1]

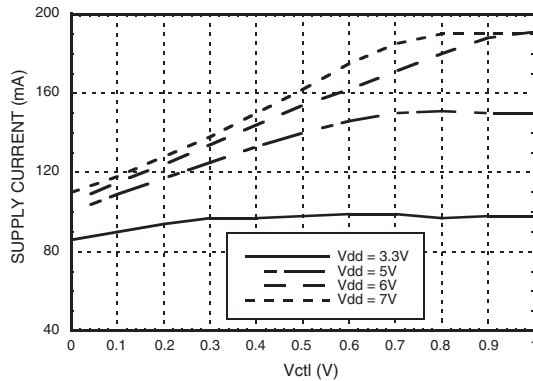

[1] Data Input = 22.5 Gbps NRZ PRBS 223-1 pattern, 1.2 Vp-p

Noise Figure vs. Temperature @ Vdd = 7V



11.25 Gbps NRZ Output Eye Diagram



| | Measurements | | | Units |
|---------------|--------------|-------|-------|-------|
| | Current | Min | Max | |
| Eye Amplitude | 3.6 | 3.6 | 3.6 | V |
| Rise Time | 20 | 20 | 20 | ps |
| Fall Time | 21.33 | 20.67 | 22 | ps |
| Jitter RMS | 1.893 | 1.87 | 2.072 | ps |

Time scale: 30.0 ps/div
Amplitude scale: 762 mV/div

Vdd = 3.3V, Vin: 11.25 Gbps NRZ PRBS 2³¹-1, 0.5 Vp-p
Vout: 3.6Vp-p
Vctl = 1V

11.25 Gbps NRZ Output Eye Diagram



| | Measurements | | | Units |
|---------------|--------------|-------|-------|-------|
| | Current | Min | Max | |
| Eye Amplitude | 7.47 | 7.47 | 7.47 | V |
| SNR | 17.97 | 17.88 | 18.12 | V/V |

Time scale: 30.0 ps/div
Amplitude scale: 1.17 V/div

Vdd = 5V, Vin: 11.25Gbps NRZ PRBS 2³¹-1, 1.2V p-p,
Vout: 7.5Vp-p
Vctl = 1V

MZ OPTICAL MODULATOR DRIVER, DC - 20 GHz



11.25 Gbps NRZ Output Eye Diagram (Continued)

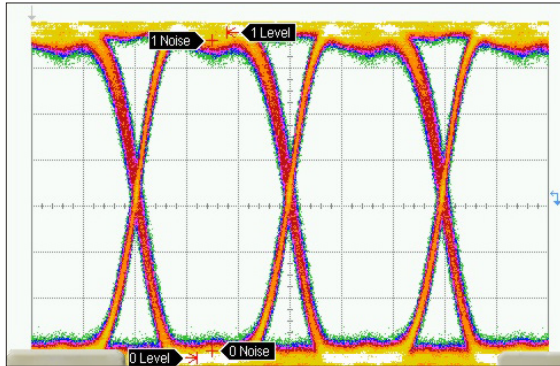

| | Measurements | | | Units |
|---------------|--------------|-------|-------|-------|
| | Current | Min | Max | |
| Eye Amplitude | 8.26 | 8.26 | 8.27 | V |
| SNR | 22.35 | 22.26 | 22.51 | V/V |

Time scale: 30.0 ps/div
Amplitude scale: 1.17 V/div

Vdd = 7V, Vin: 11.25Gbps NRZ PRBS 2³¹-1, 1.2V p-p,
Vout: 8.3Vp-p
Vctl = 1V

22.5 Gbps NRZ Output Eye Diagram

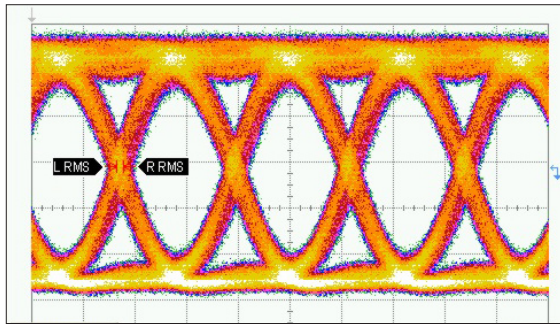

| | Measurements | | | Units |
|---------------|--------------|-------|-------|-------|
| | Current | Min | Max | |
| Eye Amplitude | 3.53 | 3.53 | 3.54 | V |
| Rise Time | 18.22 | 17.33 | 18.22 | ps |
| Fall Time | 20.44 | 19.56 | 20.89 | ps |
| Jitter RMS | 2.417 | 2.187 | 2.422 | ps |

Time scale: 20.0 ps/div
Amplitude scale: 762 mV/div

Vdd = 3.3V, Vin: 22.5Gbps NRZ PRBS 2³¹-1, 0.5V p-p,
Vout: 3.5Vp-p
Vctl = 1V

22.5 Gbps NRZ Output Eye Diagram

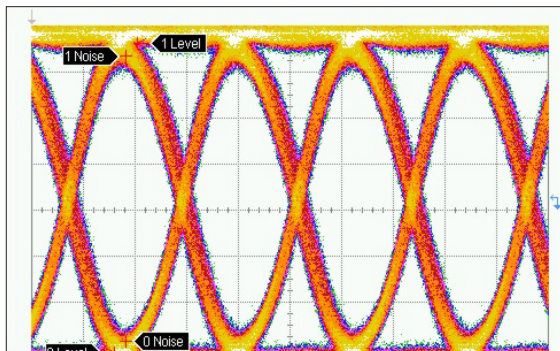

| | Measurements | | | Units |
|---------------|--------------|-------|-------|-------|
| | Current | Min | Max | |
| Eye Amplitude | 7.85 | 7.84 | 7.85 | V |
| SNR | 13.74 | 13.69 | 14.07 | V/V |

Time scale: 20.0 ps/div
Amplitude scale: 1.17 V/div

Vdd = 7V, Vin: 22.5Gbps NRZ PRBS 2³¹-1, 1.2 V p-p,
Vout: 7.9Vp-p
Vctl = 1V

Information furnished by Analog Devices is believed to be accurate and reliable. However, no responsibility is assumed by Analog Devices for its use, nor for any infringements of patents or other rights of third parties that may result from its use. Specifications subject to change without notice. No license is granted by implication or otherwise under any patent or patent rights of Analog Devices. Trademarks and registered trademarks are the property of their respective owners.

For price, delivery, and to place orders: Analog Devices, Inc., One Technology Way, P.O. Box 9106, Norwood, MA 02062-9106
Phone: 781-329-4700 • Order online at www.analog.com
Application Support: Phone: 1-800-ANALOG-D

MZ OPTICAL MODULATOR DRIVER, DC - 20 GHz



11.25 Gbps RZ Output Eye Diagram

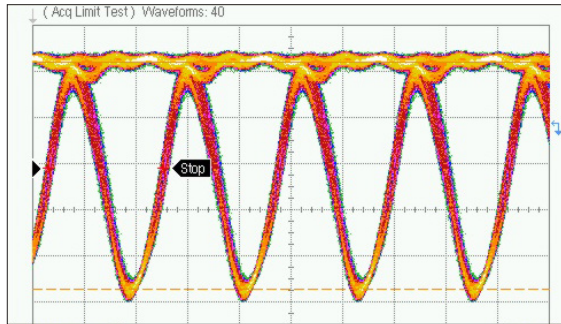

| Measurements | | |
|--------------|---------|-------|
| | Current | Units |
| Jitter RMS | 1.93 | ps |
| Bit Rate | 11.2 | Gb/s |

Time scale: 40.0 ps/div
Amplitude scale: 1.22 V/div

Vdd = 3.3V, Vin: 11.25Gbps RZ PRBS 2³¹-1, 0.3V p-p,
Vout: 2.9Vp-p
Vctl = 1V

11.25 Gbps RZ Output Eye Diagram

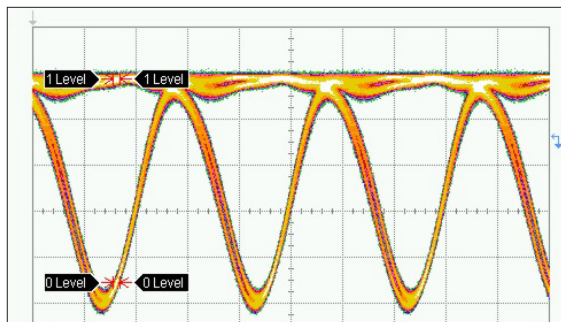

| Measurements | | | | |
|---------------|---------|-------|-------|-------|
| | Current | Min | Max | Units |
| Duty Cycle | 51.5 | 50.4 | 57.1 | % |
| SNR | 20.85 | 13.35 | 20.96 | V/V |
| Jitter RMS | 1.753 | 1.689 | 1.795 | ps |
| Eye Amplitude | 2.85 | 2.37 | 2.86 | V |

Time scale: 30.0 ps/div
Amplitude scale: 647 mV/div

Vdd = 5V, Vin: 11.25Gbps RZ PRBS 2³¹-1, 1.2V p-p,
Vout: 6Vp-p
Vctl = 1V

Absolute Maximum Ratings

| | |
|---|---------------------|
| Drain Bias Voltage (Vdd) | +9V |
| Gate Bias Voltage (Vgg) | -2V to 0V |
| Control Bias Voltage (Vctl) | (Vdd -7) to Vdd (V) |
| RF Input Power (RFIN)(Vdd = +7 Vdc) | +23 dBm |
| Channel Temperature | 175 °C |
| Continuous Pdiss (T = 85 °C) (derate 24 mW/°C above 85 °C) | 1.5 W |
| Thermal Resistance (channel to ground paddle) | 59.4 °C/W |
| Storage Temperature | -65 to +150 °C |
| Operating Temperature | -40 to +85 °C |
| ESD Sensitivity (HBM) | Class 1A |

Typical Supply Current vs. Vdd*

| Vdd (V) | Idd (mA)* | Power Dissipation (W) |
|---------|-----------|-----------------------|
| +3.3 | 100 | 0.33 |
| +5.0 | 140 | 0.70 |
| +6.0 | 160 | 0.96 |
| +7.0 | 165 | 1.115 |

* Adjust Vgg between -2V to 0V to achieve Idd shown.



ELECTROSTATIC SENSITIVE DEVICE
OBSERVE HANDLING PRECAUTIONS



MZ OPTICAL MODULATOR DRIVER, DC - 20 GHz

Outline Drawing

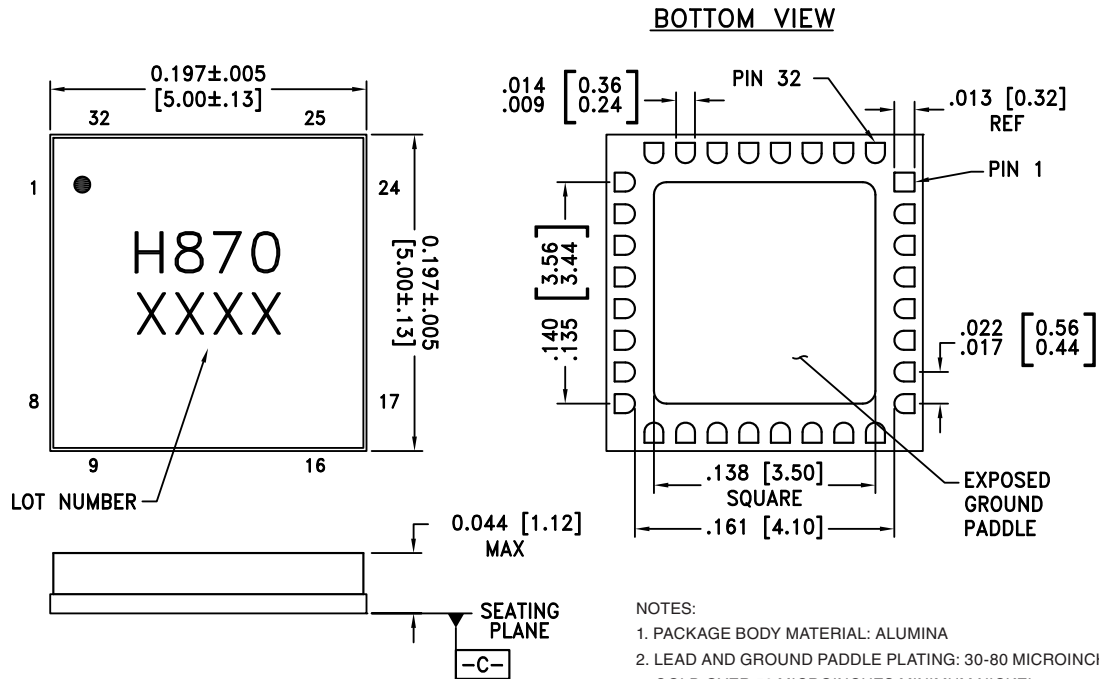

- NOTES:
1. PACKAGE BODY MATERIAL: ALUMINA
 2. LEAD AND GROUND PADDLE PLATING: 30-80 MICROINCHES GOLD OVER 50 MICROINCHES MINIMUM NICKEL.
 3. DIMENSIONS ARE IN INCHES [MILLIMETERS].
 4. LEAD SPACING TOLERANCE IS NON-CUMULATIVE.
 5. PACKAGE WARP SHALL NOT EXCEED 0.05mm DATUM [-C-]
 6. ALL GROUND LEADS AND GROUND PADDLE MUST BE SOLDERED TO PCB RF GROUND.

Package Information

| Part Number | Package Body Material | Lead Finish | MSL Rating | Package Marking ^[2] |
|-------------|-----------------------|------------------|---------------------|--------------------------------|
| HMC870LC5 | Alumina, White | Gold over Nickel | MSL3 ^[1] | H870 XXXX |



[1] Max peak reflow temperature of 260 °C

[2] 4-Digit lot number XXXX

MZ OPTICAL MODULATOR DRIVER, DC - 20 GHz

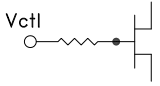
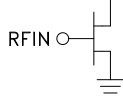

Pin Descriptions

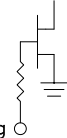
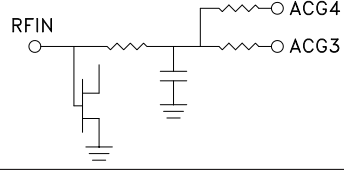
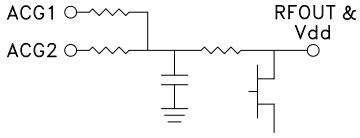
| Pin Number | Function | Description | Interface Schematic |
|---|-------------|--|---|
| 1, 3, 4, 7 - 12, 14, 17 - 19, 22 - 28, 31, 32 | N/C | The pins are not connected internally; however, all data shown herein was measured with these pins connected to RF/DC ground externally. | |
| 2 | Vctl | Output voltage swing adjustment. +1V should be applied to Vctl for nominal operation. |  |
| 5 | RFIN | This pin is DC coupled and matched to 50 Ohms. |  |
| 6, 20 | GND | RF/DC Ground. These pins and the package base must be connected to RF/DC ground. |  |
| 13 | Vgg | Gate Control for amplifier. |  |
| 15 | ACG4 | Low frequency termination. Attach bypass capacitor per application circuit herein. |  |
| 16 | ACG3 | | |
| 21 | RFOUT & Vdd | RF output for amplifier. Connect the DC bias (Vdd) network to provide drain current (Idd). See application circuit herein. |  |
| 29 | ACG2 | | |
| 30 | ACG1 | | |



**MZ OPTICAL MODULATOR
DRIVER, DC - 20 GHz**

Application Circuit

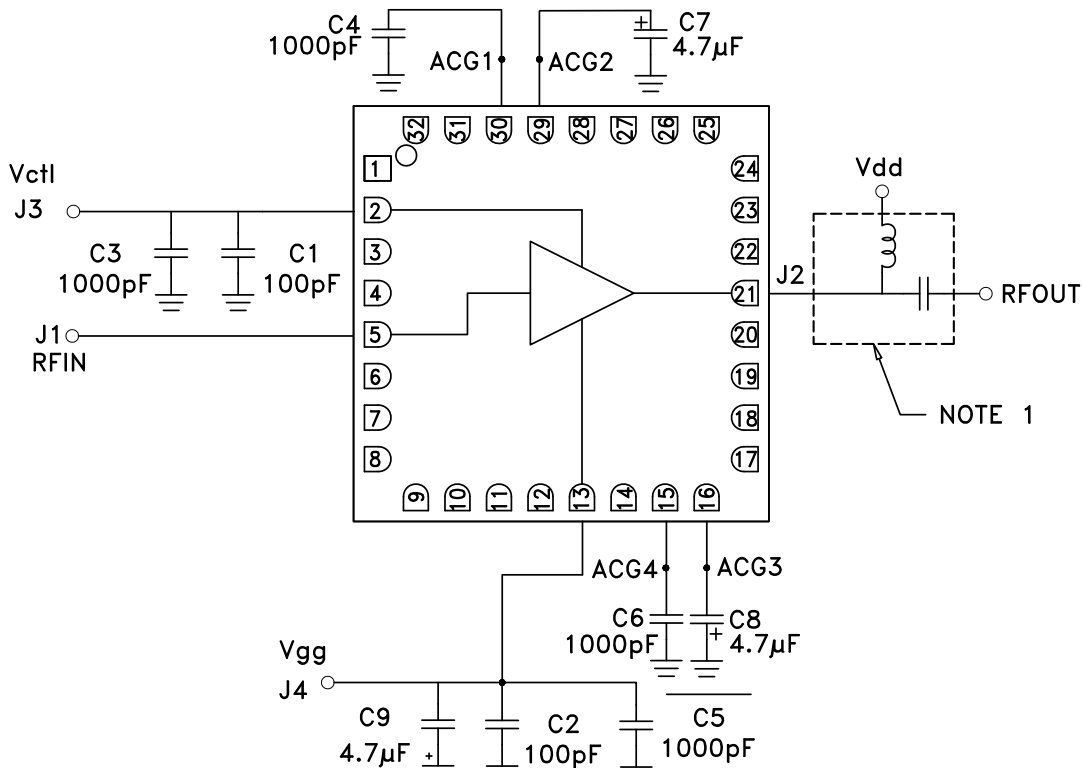

NOTE 1: Drain Bias (Vdd) must be applied through a broadband bias tee or external bias network.

Information furnished by Analog Devices is believed to be accurate and reliable. However, no responsibility is assumed by Analog Devices for its use, nor for any infringements of patents or other rights of third parties that may result from its use. Specifications subject to change without notice. No license is granted by implication or otherwise under any patent or patent rights of Analog Devices. Trademarks and registered trademarks are the property of their respective owners.

For price, delivery, and to place orders: Analog Devices, Inc., One Technology Way, P.O. Box 9106, Norwood, MA 02062-9106 Phone: 781-329-4700 • Order online at www.analog.com Application Support: Phone: 1-800-ANALOG-D



Evaluation PCB

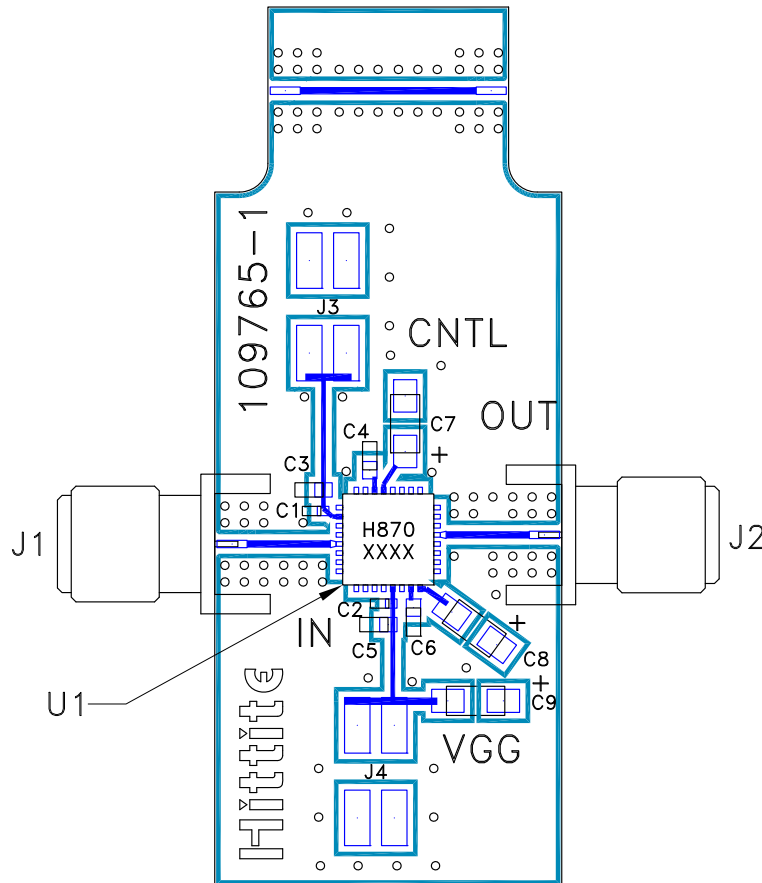

List of Materials for Evaluation PCB 108347 [1]

| Item | Description |
|---------|------------------------------|
| J1 - J2 | PCB Mount SMA Connector |
| J3 - J4 | 2mm Molex Header |
| C1, C2 | 100 pF Capacitor, 0402 Pkg. |
| C3 - C6 | 1000 pF Capacitor, 0603 Pkg. |
| C7 - C9 | 4.7 μF Capacitor, Tantalum |
| U1 | HMC870LC5, Modulator Driver |
| PCB [2] | 109765 Evaluation PCB |

[1] Reference this number when ordering complete evaluation PCB

[2] Circuit Board Material: Arlon 25FR or Rogers 4350

The circuit board used in the application should use RF circuit design techniques. Signal lines should have 50 Ohm impedance while the package ground leads and package bottom should be connected directly to the ground plane similar to that shown. A sufficient number of via holes should be used to connect the top and bottom ground planes. The evaluation board should be mounted to an appropriate heat sink. The evaluation circuit board shown is available from Hittite upon request.

**MZ OPTICAL MODULATOR
DRIVER, DC - 20 GHz****Device Operation**

These devices are susceptible to damage from Electrostatic Discharge. Proper precautions should be observed during handling, assembly and test.

The input to this device should be AC-coupled. To provide the typical 8Vp-p output voltage swing, a 1.2Vp-p AC-coupled input voltage swing is required.

Device Power Up Instructions

1. Ground the device
 2. Set V_{gg} to -2V (no drain current)
 3. Set V_{ctl} to +1V (no drain current)
 4. Set V_{dd} to +5V (no drain current)
 5. Adjust V_{gg} for I_{dd} = 140mA
- V_{gg} may be varied between -1V and 0V to provide the desired eye crossing point percentage (i.e. 50% crosspoint) and a limited cross point control capability.
 - V_{dd} may be increased to +7V if required to achieve greater output voltage swing.
 - V_{ctl} may be adjusted between +2V and +0V to vary the output voltage swing.

Device Power Down Instructions

1. Reverse the sequence identified above in steps 1 through 4.

**MZ OPTICAL MODULATOR
DRIVER, DC - 20 GHz**