

FEATURES

- Charge pump with automatic gain selection of 1×, 1.5×, and 2× for maximum efficiency**
- 92% peak efficiency**
- 9 independent and programmable LED drivers**
- Each driver is capable of 25 mA (full scale)**
- Each driver has 7 bits (128 levels) of nonlinear current settings**
- Standby mode for <math><1 \mu\text{A}</math> current consumption**
- 16 programmable fade-in and fade-out times (0.0 sec to 1.75 sec) with choice of square or cubic rates**
- Automated and customizable LED blinking**
- Unique heartbeat mode for programmable double pulse lighting effects on 4 channels (D6 to D9)**
- PWM input for implementing content adjustable brightness control (cABC)**
- I²C compatible interface for all programming**
- Dedicated reset pin and built-in power on reset (POR)**
- Short circuit, overvoltage, and overtemperature protection**
- Internal soft start to limit inrush currents**
- Input to output isolation during faults or shutdown**
- Operates down to $V_{\text{IN}} = 2.5 \text{ V}$, with undervoltage lockout (UVLO) at 1.9 V**
- Small lead frame chip scale package (LFCSP)**

GENERAL DESCRIPTION

The ADP8866 combines a programmable backlight LED charge pump driver with automatic blinking functions. Nine LED drivers can be independently programmed at currents up to 25 mA. The current level, fade time, and blinking rate can be programmed once and executed autonomously on a loop. Separate fade-in and fade-out times can be set for the backlight LEDs.

APPLICATIONS

- Mobile display backlighting
- Mobile phone keypad backlighting
- LED indication and status lights
- Automated LED blinking

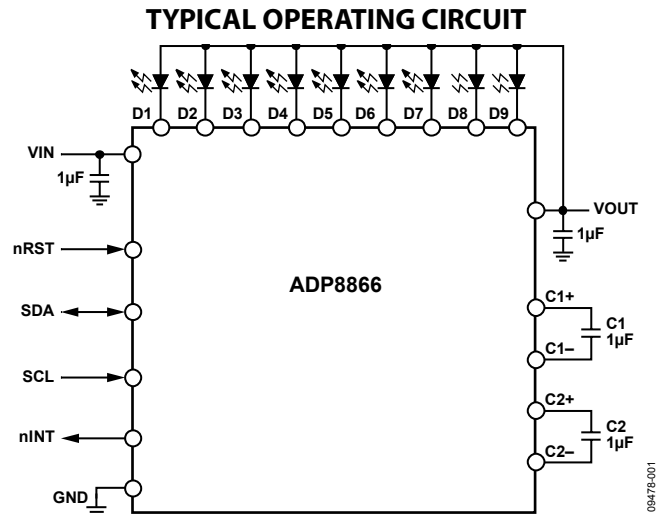

Figure 1.

Driving all of this is a two-capacitor charge pump with gains of 1×, 1.5×, and 2×. This setup is capable of driving a maximum I_{OUT} of 240 mA from a supply of 2.5 V to 5.5 V. A full suite of safety features including short-circuit, overvoltage, and over-temperature protection allows easy implementation of a safe and robust design. Additionally, input inrush currents are limited via an integrated soft start combined with controlled input to output isolation.

TABLE OF CONTENTS

Features	1	Automated Fade-in and Fade-Out	14
Applications	1	CABC Fade Disable	15
Typical Operating Circuit	1	Independent Sink Control (ISC)	15
General Description	1	Advanced Blinking Controls	16
Revision History	2	Short-Circuit Protection (SCP) Mode	17
Specifications	3	Overvoltage Protection (OVP)	17
Absolute Maximum Ratings	5	Thermal Shutdown (TSD)/Overtemperature Protection	17
Maximum Temperature Ranges	5	Interrupts	19
Thermal Resistance	5	Backlight Off Interrupt	19
ESD Caution	5	Independent Sink Off Interrupt	19
Pin Configurations and Function Descriptions	6	Applications Information	20
Typical Performance Characteristics	7	Layout Guidelines	20
Theory of Operation	11	I ² C Programming and Digital Control	21
Power Stage	12	Register Descriptions	22
Operating Modes	13	Backlight Register Descriptions	29
LED Groups	14	Independent Sink Register Descriptions	34
Output Current Settings	14	Outline Dimensions	50
Output Current Range Selection	14	Ordering Guide	50
PWM Dimming	14		

REVISION HISTORY

11/2017—Rev. A to Rev. B

Changed CP-20-10 to CP-20-8	Throughout
Updated Outline Dimensions	50
Changes to Ordering Guide	50

1/2014—Rev. 0 to Rev. A

Changes to Figure 40 and Figure 41	21
--	----

3/2011—Revision 0: Initial Version

SPECIFICATIONS

$V_{IN} = 3.6\text{ V}$, $SCL = 2.7\text{ V}$, $SDA = 2.7\text{ V}$, $nINT = \text{open}$, $nRST = 2.7\text{ V}$, $V_{D1:D9} = 0.4\text{ V}$, $C1 = 1\text{ }\mu\text{F}$, $C2 = 1\text{ }\mu\text{F}$, $C_{OUT} = 1\text{ }\mu\text{F}$, typical values are at $T_j = 25^\circ\text{C}$ and are not guaranteed. Minimum and maximum limits are guaranteed from $T_j = -40^\circ\text{C}$ to $+105^\circ\text{C}$, unless otherwise noted.

Table 1.

Parameter	Symbol	Test Conditions/Comments	Min	Typ	Max	Unit
SUPPLY						
Input Voltage						
Operating Range	V_{IN}		2.5		5.5	V
Startup Level	$V_{IN(START)}$	V_{IN} increasing		1.98	2.25	V
Low Level	$V_{IN(STOP)}$	V_{IN} decreasing	1.75	1.90		V
$V_{IN(START)}$ Hysteresis	$V_{IN(HYS)}$	After startup		80		mV
UVLO Noise Filter	t_{UVLO}			10		μs
Quiescent Current	I_Q					
During Standby	$I_{Q(STBY)}$	$V_{IN} = 3.6\text{ V}$, Bit nSTBY = 0, SCL = SDA = 0 V		0.25	1.0	μA
Current Consumption	$I_{Q(OFF)}$	$V_{IN} = 3.6\text{ V}$, Bit nSTBY = 1, $I_{OUT} = 0\text{ mA}$ Measured during blinking off time		245	325	μA
During Blinking Off Time						
Switching	$I_{Q(ACTIVE)}$	$V_{IN} = 3.6\text{ V}$, Bit nSTBY = 1, $I_{OUT} = 0\text{ mA}$ Gain = 1.0X Gain = 1.5X Gain = 2.0X		1.2 3.7 4.3	2.0 5.4 6.2	mA mA mA
OSCILLATOR						
Switching Frequency	f_{SW}	Charge pump gain = 2X	0.8	1	1.2	MHz
Duty Cycle	D			50		%
OUTPUT CURRENT CONTROL						
Maximum Drive Current	$I_{D1:D9(MAX)}$	$V_{D1:D9} = 0.4\text{ V}$	23.0	25.0	27.0	mA
$T_j = 25^\circ\text{C}$						
$T_j = -40^\circ\text{C}$ to $+85^\circ\text{C}$			22.5		27.5	mA
LED Current Source Matching	I_{MATCH}					
All Current Sinks	I_{MATCH9}	$V_{D1:D9} = 0.4\text{ V}$		1.4		%
D1 to D5 Current Sinks	I_{MATCH5}	$V_{D1:D5} = 0.4\text{ V}$		1.1		%
Leakage Current on LED Pins	$I_{D1:D9(LKG)}$	$V_{IN} = 5.5\text{ V}$, $V_{D1:D9} = 2.5\text{ V}$, Bit nSTBY = 1			0.5	μA
Equivalent Output Resistance	R_{OUT}					
Gain = 1X		$V_{IN} = 3.6\text{ V}$, $I_{OUT} = 100\text{ mA}$		0.5		Ω
Gain = 1.5X		$V_{IN} = 3.1\text{ V}$, $I_{OUT} = 100\text{ mA}$		3.0		Ω
Gain = 2X		$V_{IN} = 2.5\text{ V}$, $I_{OUT} = 100\text{ mA}$		3.8		Ω
Regulated Output Voltage	$V_{OUT(REG)}$	$V_{IN} = 3\text{ V}$, gain = 2X, $I_{OUT} = 10\text{ mA}$	4.4	4.9	5.2	V
AUTOMATIC GAIN SELECTION						
Minimum Voltage						
Gain Increases	$V_{HR(UP)}$	Decrease V_{DX} until the gain switches up	145	200	240	mV
Minimum Current Sink	$V_{HR(MIN)}$	$I_{DX} = I_{DX(MAX)} \times 95\%$			210	mV
Headroom Voltage						
Gain Delay	t_{GAIN}	The delay after gain has changed and before gain is allowed to change again		100		μs
FAULT PROTECTION						
Startup Charging Current	I_{SS}	$V_{IN} = 3.6\text{ V}$, $V_{OUT} = 0.8 \times V_{IN}$	3.5	7	11	mA
Source						
Output Voltage Threshold	V_{OUT}					
Exit Soft Start	$V_{OUT(START)}$	V_{OUT} rising		$0.92 \times V_{IN}$		V
Short-Circuit Protection	$V_{OUT(SC)}$	V_{OUT} falling		$0.55 \times V_{IN}$		V
Output Overvoltage Protection	V_{OVP}					
Activation Level				5.7	6.0	V
OVP Recovery Hysteresis				500		mV

Parameter	Symbol	Test Conditions/Comments	Min	Typ	Max	Unit
Thermal Shutdown Threshold	TSD	Increasing temperature		150		°C
Thermal Shutdown Hysteresis	TSD _(HYS)			20		°C
Isolation from Input to Output During Fault	I _{OUTLKG}	V _{IN} = 5.5 V, V _{OUT} = 0 V, Bit nSTBY = 0			1	μA
Time to Validate a Fault	t _{FAULT}			2		μs
I²C INTERFACE						
V _{DDIO} Voltage Operating Range	V _{DDIO}				5.5	V
Logic Low Input	V _{IL}	V _{IN} = 2.5 V			0.5	V
Logic High Input	V _{IH}	V _{IN} = 5.5 V	1.55			V
I²C TIMING SPECIFICATIONS						
Delay from Reset Deassertion to I ² C Access	t _{RESET}	Guaranteed by design			20	μs
SCL Clock Frequency	f _{SCL}				400	kHz
SCL High Time	t _{HIGH}		0.6			μs
SCL Low Time	t _{LOW}		1.3			μs
Setup Time						
Data	t _{SU, DAT}		100			ns
Repeated Start	t _{SU, STA}		0.6			μs
Stop Condition	t _{SU, STO}		0.6			μs
Hold Time						
Data	t _{HD, DAT}		0		0.9	μs
Start/Repeated Start	t _{HD, STA}		0.6			μs
Bus Free Time (Stop and Start Conditions)	t _{BUF}		1.3			μs
Rise Time (SCL and SDA)	t _R		20 + 0.1 × C _B		300	ns
Fall Time (SCL and SDA)	t _F		20 + 0.1 × C _B		300	ns
Pulse Width of Suppressed Spike	t _{SP}		0		50	ns
Capacitive Load Per Bus Line	C _B				400	pF

Timing Diagram

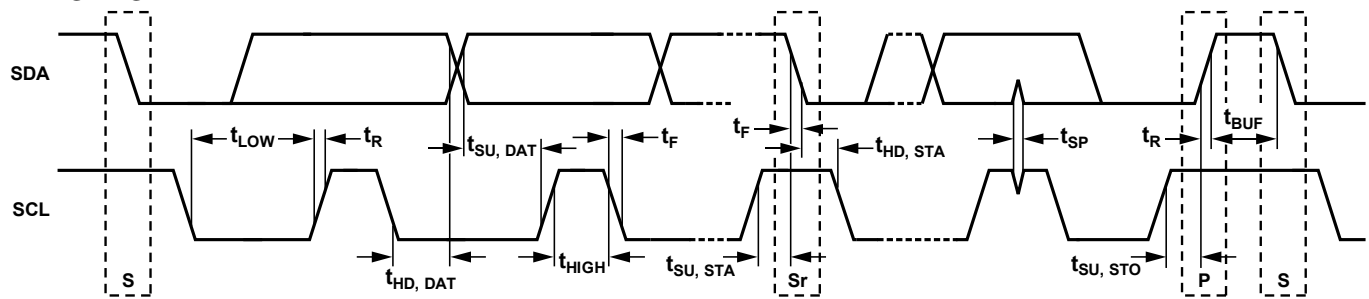

S = START CONDITION
 Sr = REPEATED START CONDITION
 P = STOP CONDITION

Figure 2. I²C Interface Timing Diagram

09475-002

ABSOLUTE MAXIMUM RATINGS

Table 2.

Parameter	Rating
VIN, VOUT to GND	−0.3 V to +6 V
D1, D2, D3, D4, D5, D6, D7, D8, and D9 to GND	−0.3 V to +6 V
nINT, nRST, SCL, and SDA to GND	−0.3 V to +6 V
Output Short-Circuit Duration	Indefinite
Operating Ambient Temperature Range	−40°C to +85°C ¹
Operating Junction Temperature Range	−40°C to +125°C
Storage Temperature Range	−65°C to +150°C
Soldering Conditions	JEDEC J-STD-020
ESD (Electrostatic Discharge)	
Human Body Model (HBM)	±2.0 kV
Charged Device Model (CDM)	±1.5 kV

¹ The maximum operating junction temperature ($T_{J(MAX)}$) supersedes the maximum operating ambient temperature ($T_{A(MAX)}$). See the Maximum Temperature Ranges section for more information.

Stresses at or above those listed under Absolute Maximum Ratings may cause permanent damage to the product. This is a stress rating only; functional operation of the product at these or any other conditions above those indicated in the operational section of this specification is not implied. Operation beyond the maximum operating conditions for extended periods may affect product reliability.

Absolute maximum ratings apply individually only, not in combination. Unless otherwise specified, all voltages are referenced to GND.

MAXIMUM TEMPERATURE RANGES

The maximum operating junction temperature ($T_{J(MAX)}$) supersedes the maximum operating ambient temperature ($T_{A(MAX)}$). Therefore, in situations where the ADP8866 is exposed to poor thermal resistance and a high power dissipation (P_D), the maximum ambient temperature may need to be derated. In these cases, the ambient temperature maximum can be calculated with the following equation:

$$T_{A(MAX)} = T_{J(MAX)} - (\theta_{JA} \times P_{D(MAX)})$$

THERMAL RESISTANCE

The θ_{JA} (junction to air) and θ_{JC} (junction to case) are determined according to JESD51-9 on a 4-layer printed circuit board (PCB) with natural convection cooling. The exposed pad must be soldered to GND.

Table 3. Thermal Resistance

Package Type	θ_{JA}	θ_{JC}	Unit
LFCSFP	38.6	3.56	°C/W

ESD CAUTION



ESD (electrostatic discharge) sensitive device. Charged devices and circuit boards can discharge without detection. Although this product features patented or proprietary protection circuitry, damage may occur on devices subjected to high energy ESD. Therefore, proper ESD precautions should be taken to avoid performance degradation or loss of functionality.

PIN CONFIGURATIONS AND FUNCTION DESCRIPTIONS

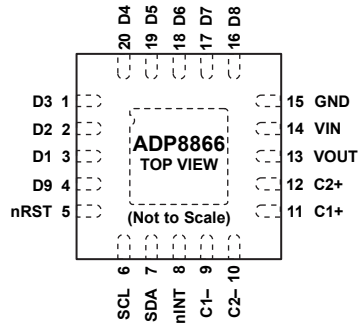

NOTES
1. CONNECT THE EXPOSED PADDLE TO GND.

09478-003

Figure 3. LFCSP Pin Configuration

Table 4. Pin Function Descriptions

Pin No.	Mnemonic	Description
14	VIN	Battery Voltage 2.5 V to 5.5 V.
3	D1	LED Sink 1 Output.
2	D2	LED Sink 2 Output.
1	D3	LED Sink 3 Output.
20	D4	LED Sink 4 Output.
19	D5	LED Sink 5 Output.
18	D6	LED Sink 6 Output.
17	D7	LED Sink 7 Output.
16	D8	LED Sink 8 Output.
4	D9	LED Sink 9 Output.
13	VOUT	Charge Pump Output.
11	C1+	Charge Pump C1+.
9	C1-	Charge Pump C1-.
12	C2+	Charge Pump C2+.
10	C2-	Charge Pump C2-.
15	GND	Ground. Connect the exposed paddle to GND.
8	nINT	Processor Interrupt (Active Low). Requires an external pull-up resistor. If this pin is not used, it can be left floating. Alternatively, this pin can be set as the PWM input for implementing cABC dimming (see the PWM Dimming section).
5	nRST	Hardware Reset Input (Active Low). This bit resets the device to the default conditions. If not used, this pin must be tied above $V_{IH(MAX)}$.
7	SDA	I ² C Serial Data Input. Requires an external pull-up resistor.
6	SCL	I ² C Clock Input. Requires an external pull-up resistor.

TYPICAL PERFORMANCE CHARACTERISTICS

V_{IN} = 3.6 V, SCL = 2.7 V, SDA = 2.7 V, nRST = 2.7 V, V_{D11:D9} = 0.4 V, I_{OUT} = 0 mA, C_{IN} = 1 μF, C1 = 1 μF, C2 = 1 μF, C_{OUT} = 1 μF, T_A = 25°C, unless otherwise noted.

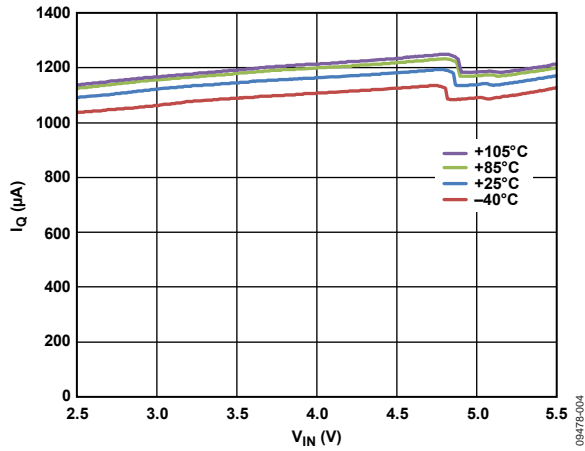

Figure 4. Typical Operating Current, G = 1×

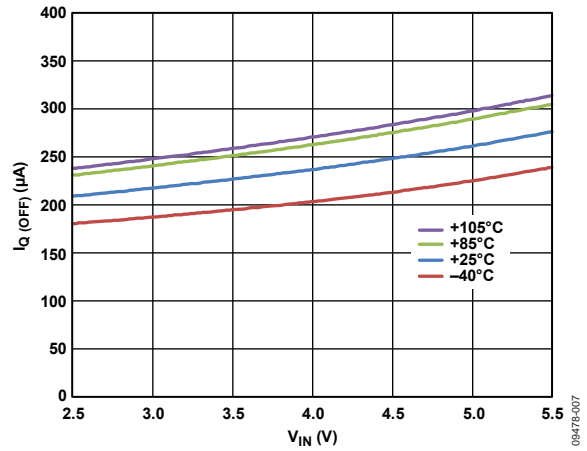

Figure 7. Typical Off Time Current (I_{q(OFF)})

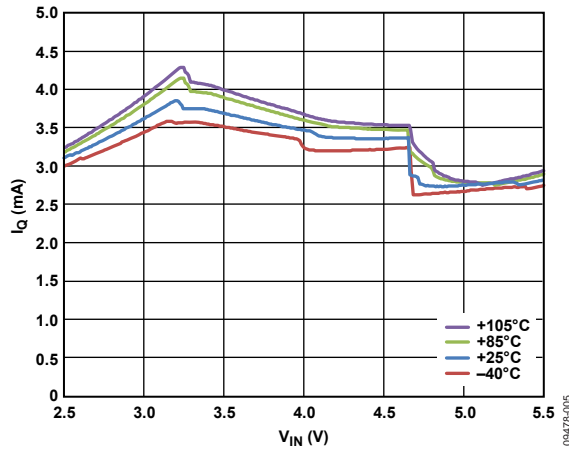

Figure 5. Typical Operating Current, G = 1.5×

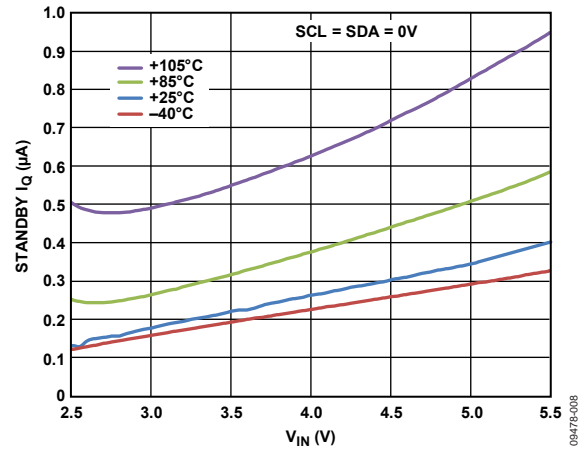

Figure 8. Typical Standby I_q

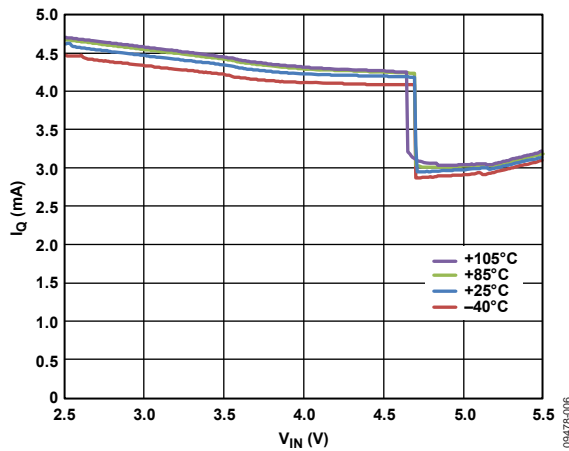

Figure 6. Typical Operating Current, G = 2×

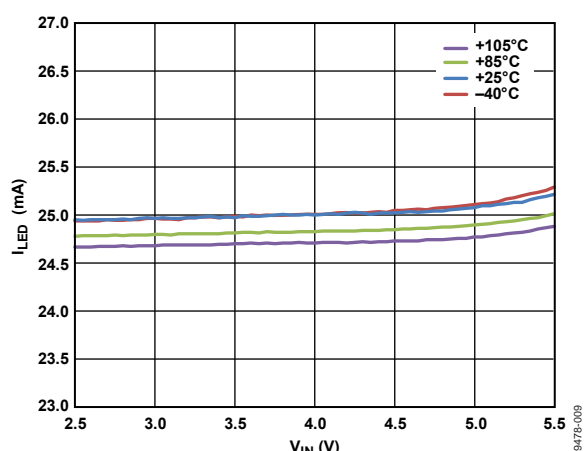

Figure 9. Typical Diode Current vs. V_{IN}

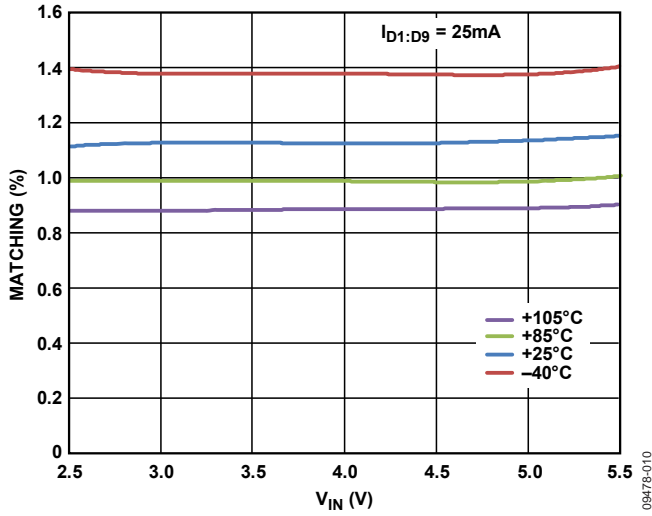

Figure 10. Typical Diode Matching vs. V_{IN}

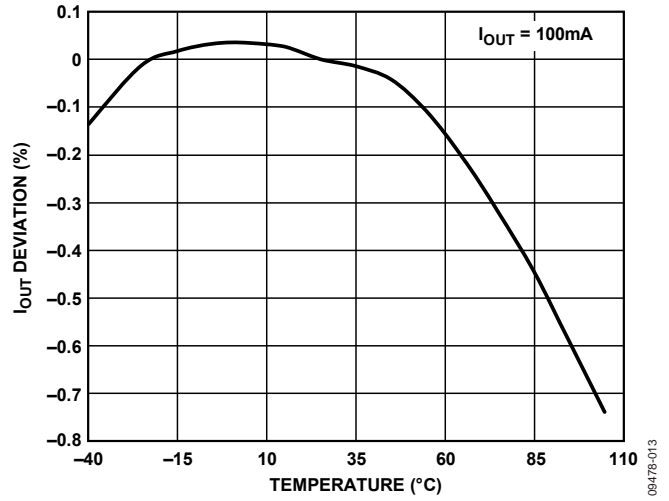

Figure 13. Typical Change in Diode Current vs. Temperature

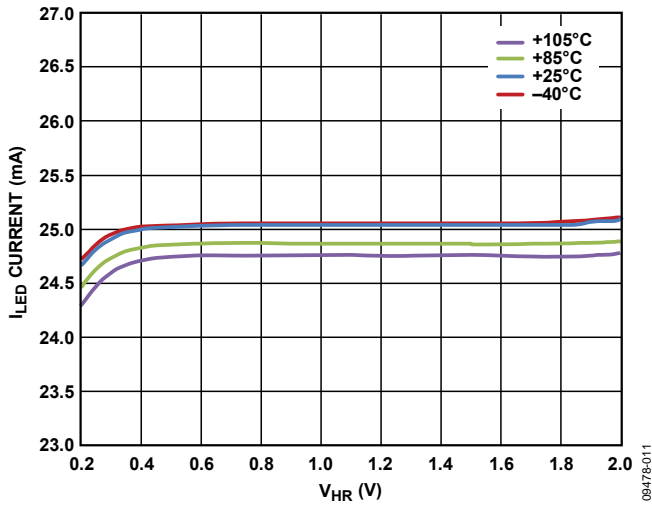

Figure 11. Typical Diode Matching vs. Current Sink Headroom Voltage (V_{HR})

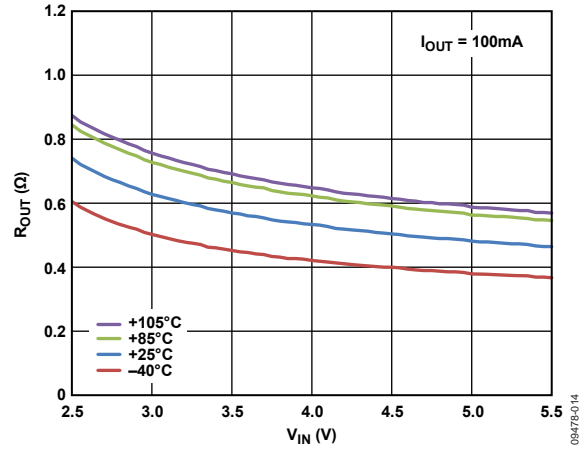

Figure 14. Typical R_{OUT} ($G = 1\times$) vs. V_{IN}

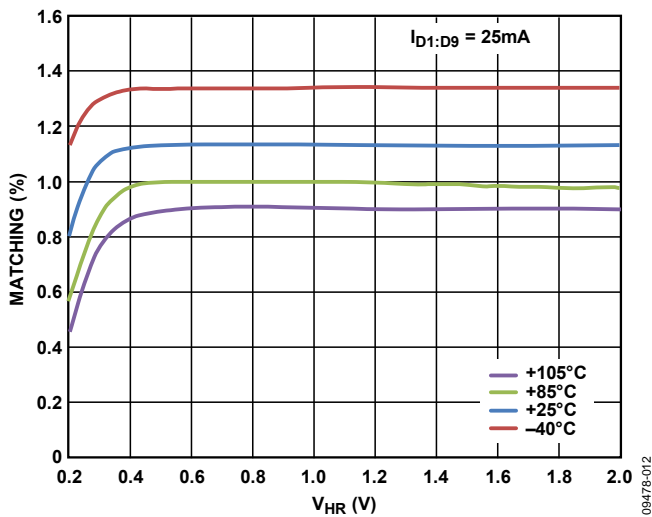

Figure 12. Typical Diode Current vs. Current Sink Headroom Voltage (V_{HR})

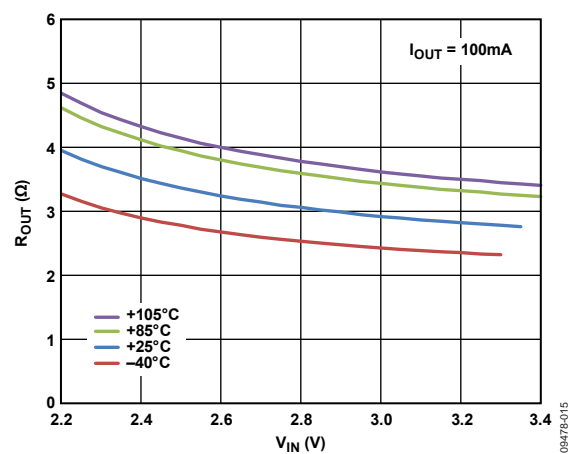

Figure 15. Typical R_{OUT} ($G = 1.5\times$) vs. V_{IN}

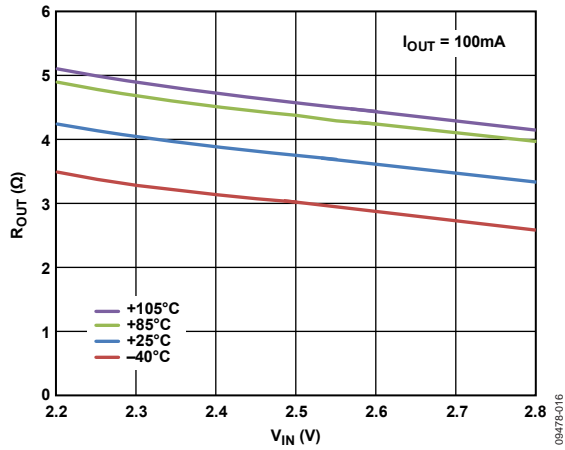

Figure 16. Typical R_{OUT} ($G = 2\times$) vs. V_{IN}

09478-016

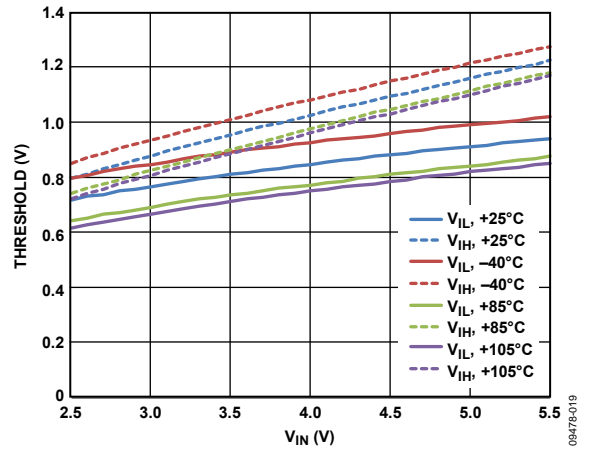

Figure 19. Typical I^2C Thresholds, V_{IH} and V_{IL}

09478-019

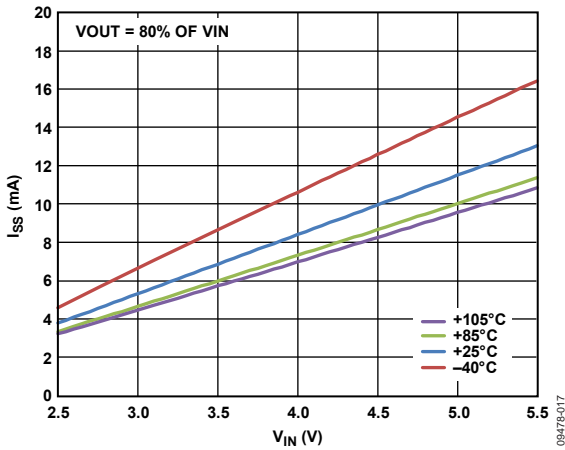

Figure 17. Typical Output Soft Start Current, I_{SS}

09478-017

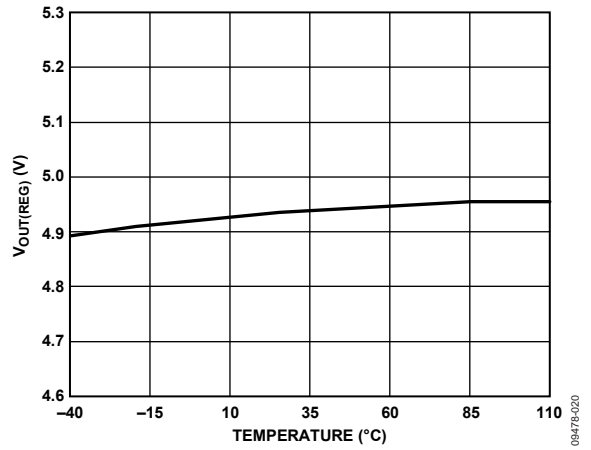

Figure 20. Typical Regulated Output Voltage ($V_{OUT(REG)}$)

09478-020

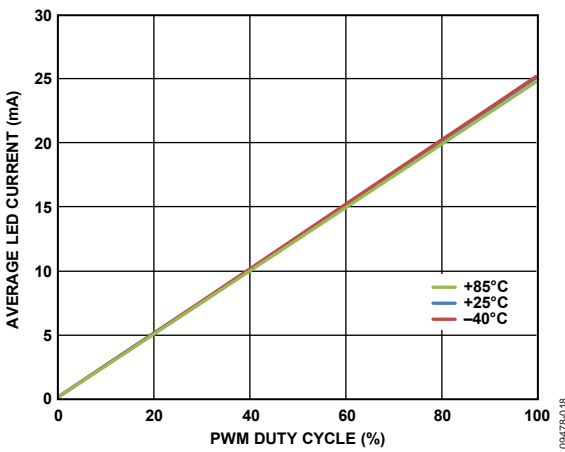

Figure 18. Typical Average I_{OUT} vs. PWM Duty ($f_{PWM} = 300$ Hz)

09478-018

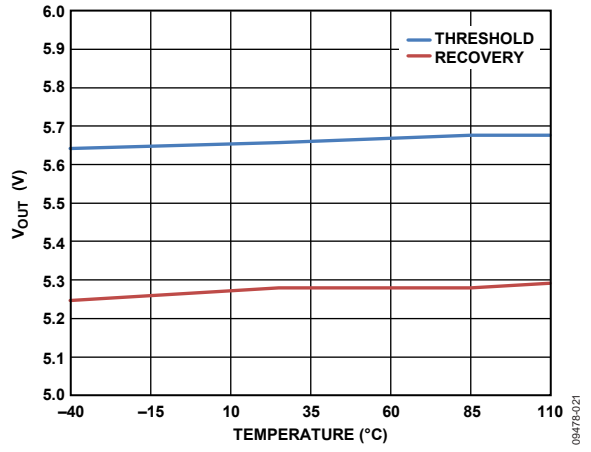

Figure 21. Typical Overvoltage Protection (OVP) Threshold

09478-021

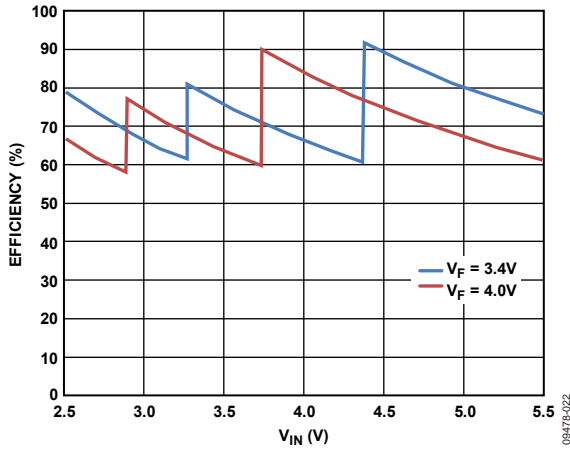

Figure 22. Typical Efficiency (Each LED Set to 25 mA)

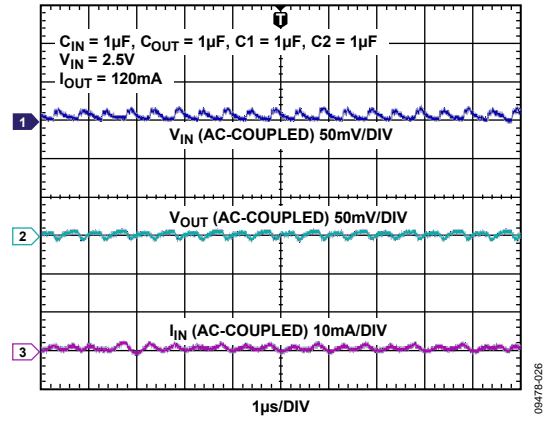

Figure 25. Typical Operating Waveforms, G = 2x

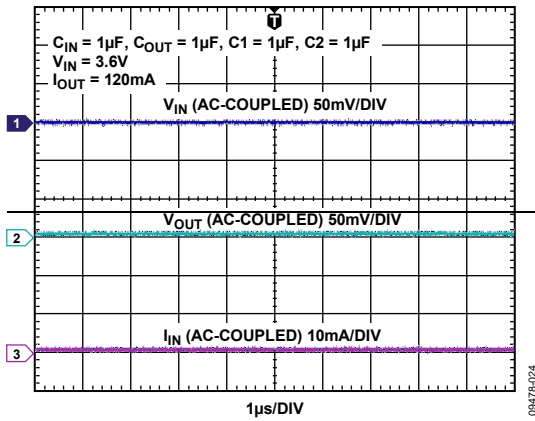

Figure 23. Typical Operating Waveforms, G = 1x

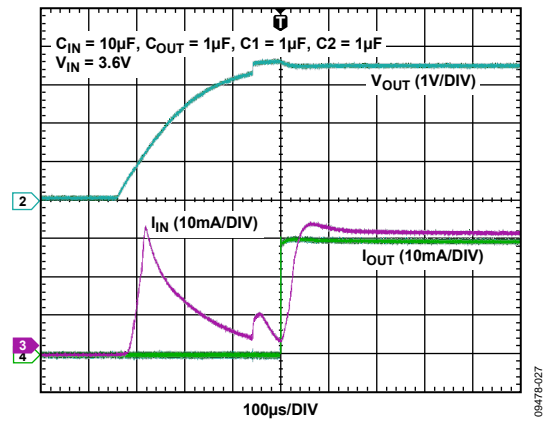

Figure 26. Typical Startup Waveforms

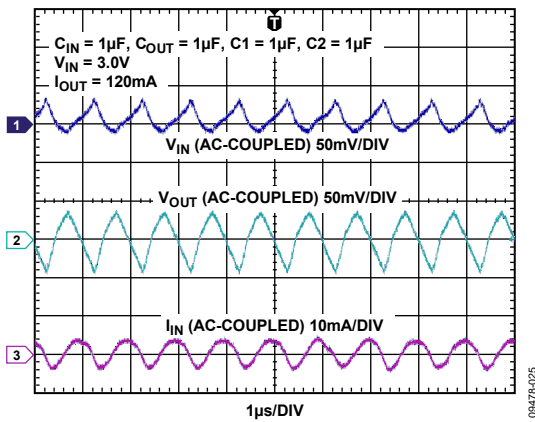

Figure 24. Typical Operating Waveforms, G = 1.5x

THEORY OF OPERATION

The ADP8866 combines a programmable backlight LED charge pump driver with automatic blinking functions. Nine LED drivers can be independently programmed at currents up to 25 mA. The current level, fade time, and blinking rate can be programmed once and executed autonomously on a loop. Separate fade-in and fade-out times can be set for the backlight LEDs.

Driving all of this is a two capacitor charge pump with gains of 1x, 1.5x, and 2x. This setup is capable of driving a maximum I_{OUT} of 240 mA from a supply of 2.5 V to 5.5 V. A full suite of safety features including short-circuit, overvoltage, and over-temperature protection allows easy implementation of a safe and robust design. Additionally, input inrush currents are limited via an integrated soft start combined with controlled input to output isolation.

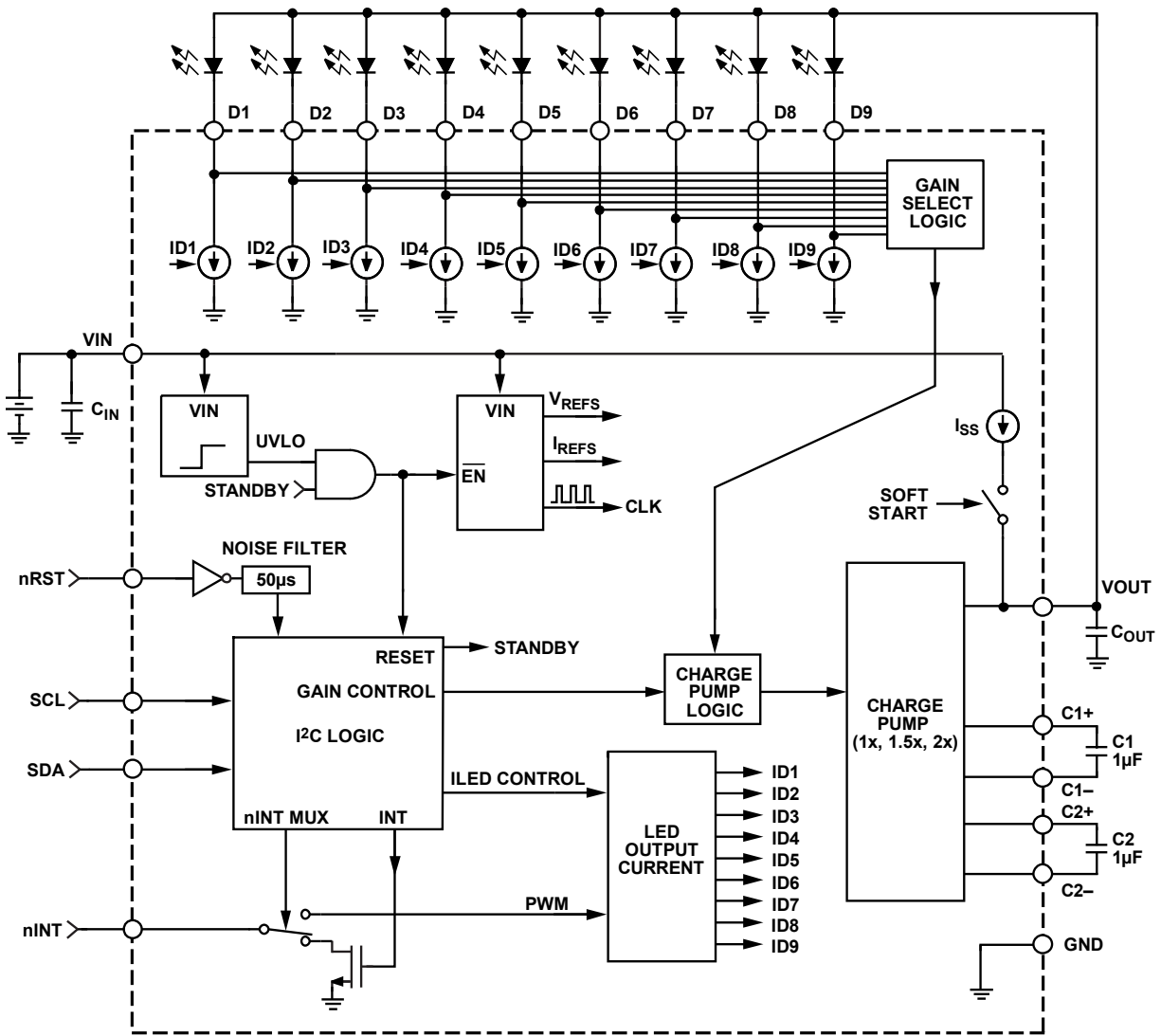

Figure 27. Detailed Block Diagram

09478-028

POWER STAGE

Typical white LEDs require up to 4 V to drive them. Therefore, some form of boosting is required to cover the typical Li Ion battery voltage variation. The ADP8866 accomplishes this with a high efficiency charge pump capable of producing a maximum I_{OUT} of 240 mA over the entire input voltage range of 2.5 V to 5.5 V. Charge pumps use the basic principle that a capacitor stores charge based on the voltage applied to it, as shown in the following equation:

$$Q = C \times V \tag{1}$$

By charging the capacitors in different configurations, the charge and, therefore, the gain can be optimized to deliver the voltage required to power the LEDs. Because a fixed charging and discharging combination must be used, only certain multiples of gain are available. The ADP8866 is capable of automatically optimizing the gain (G) from 1×, 1.5×, and 2×. These gains are accomplished with two capacitors and an internal switching network.

In G = 1× mode, the switches are configured to pass VIN directly to VOUT. In this mode, several switches are connected in parallel to minimize the resistive drop from input to output. In G = 1.5× and G = 2× modes, the switches alternatively charge from the battery and discharge into the output. For G = 1.5×,

the capacitors are charged from VIN in series and are discharged to VOUT in parallel. For G = 2×, the capacitors are charged from VIN in parallel and are discharged to VOUT in parallel. In certain fault modes, the switches are opened and the output is physically isolated from the input.

Automatic Gain Selection

Each LED that is driven requires a current source. The voltage on this current source must be greater than a minimum headroom voltage (V_{HR(MIN)}) in Table 1) to maintain accurate current regulation. The gain is automatically selected based on the minimum voltage (V_{DX}) at all of the current sources. At startup, the device is placed into G = 1× mode and the output charges to VIN. If any V_{DX} level is less than the required headroom, the gain is increased to the next step (G = 1.5×). A 100 μs delay is allowed for the output to stabilize prior to the next gain switching decision. If there remains insufficient current sink headroom, the gain is increased again to 2×. Conversely, to optimize efficiency, it is not desirable for the output voltage to be too high. Therefore, the gain reduces when the headroom voltage is too great. This point (labeled V_{D(MAX)} in Figure 28) is internally calculated to ensure that the lower gain still results in ample headroom for all the current sinks. The entire cycle is illustrated in Figure 28.

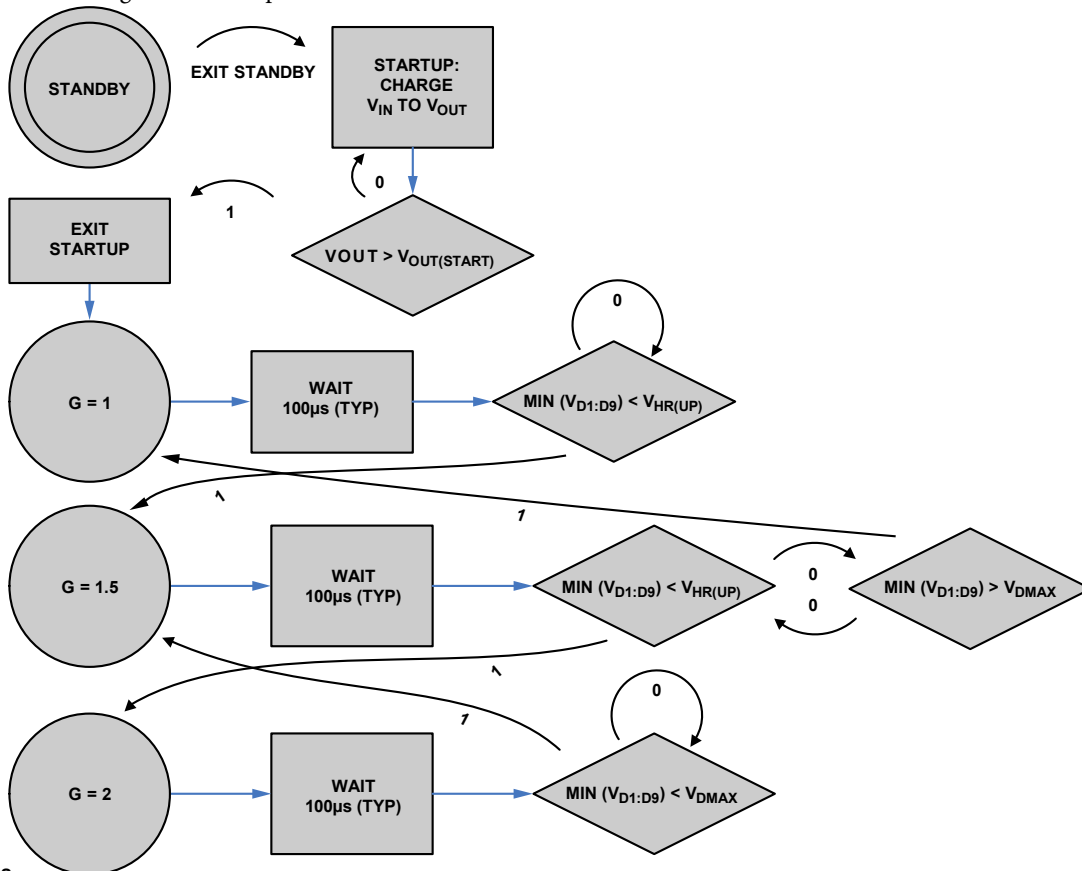

NOTES
1. V_{D(MAX)} IS THE CALCULATED GAIN DOWN TRANSITION POINT.

09478-029

Figure 28. State Diagram for Automatic Gain Selection

Note that the gain selection criteria applies only to active current sources. If a current source has been deactivated through an I²C command (that is, only five LEDs are used for an application), the voltages on the deactivated current sources are ignored.

Soft Start Feature

At startup (either from UVLO activation or fault/standby recovery), the output is first charged by I_{SS} (7.0 mA typical) until it reaches about 92% of V_{IN}. This soft start feature reduces the inrush current that is otherwise present when the output capacitance is initially charged to V_{IN}. When this point is reached, the controller enters 1× mode. If the output voltage is not sufficient, the automatic gain selection determines the optimal point as defined in the Automatic Gain Selection section.

OPERATING MODES

There are four different operating modes: active, standby, shutdown, and reset.

Active Mode

In active mode, all circuits are powered up and in a fully operational state. This mode is entered when nSTBY (in Register MDCR) is set to 1.

Standby Mode

Standby mode disables all circuitry except for the I²C receivers. Current consumption is reduced to less than 1 μA. This mode is entered when nSTBY is set to 0 or when the nRST pin is held

low for more than 100 μs (maximum). When standby is exited, a soft start sequence is performed.

Shutdown Mode

Shutdown mode disables all circuitry, including the I²C receivers. Shutdown occurs when V_{IN} is below the undervoltage thresholds. When V_{IN} rises above V_{IN(START)} (2.0 V typical), all registers are reset and the part is placed into standby mode.

Reset Mode

In reset mode, all registers are set to their default values and the part is placed into standby. There are two ways to reset the part: power on reset (POR) and the nRST pin. POR is activated any-time that the part exits shutdown mode. After a POR sequence is complete, the part automatically enters standby mode.

After startup, the part can be reset by pulling the nRST pin low. As long as the nRST pin is low, the part is held in a standby state but no I²C commands are acknowledged (all registers are kept at their default values). After releasing the nRST pin, all registers remain at their default values, and the part remains in standby; however, the part does accept I²C commands.

The nRST pin has a 50 μs (typical) noise filter to prevent inadvertent activation of the reset function. The nRST pin must be held low for this entire time to activate reset.

The operating modes function according to the timing diagram in Figure 29.

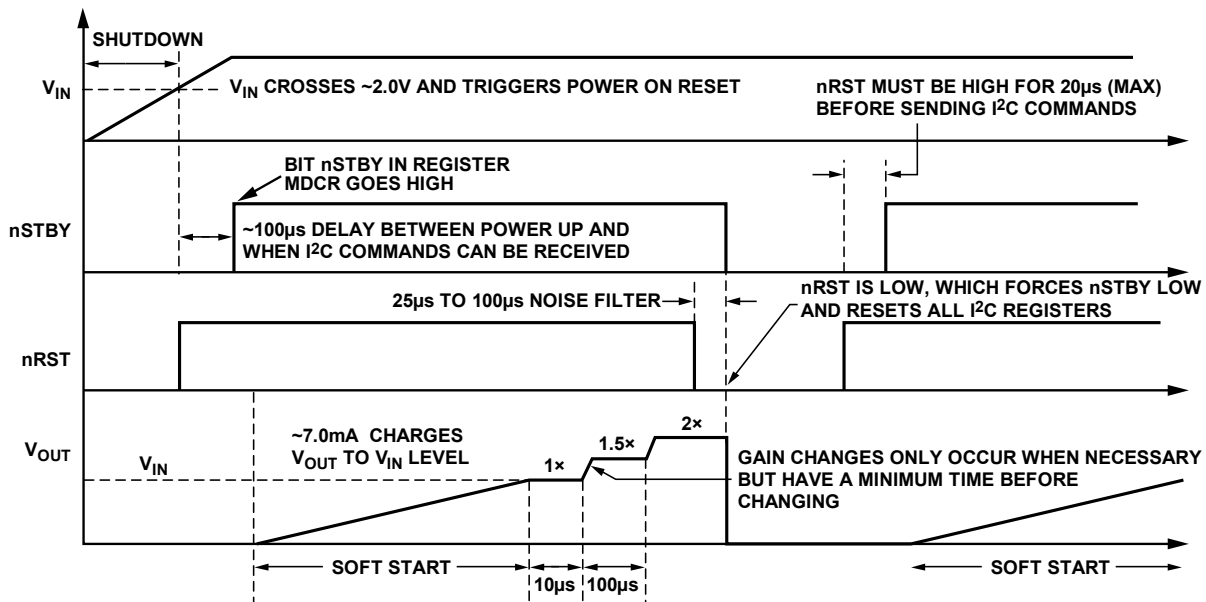

Figure 29. Typical Timing Diagram

09478-030

LED GROUPS

The nine LED channels can be separated into two groups: backlight (BL) and independent sinks (ISC). The group select is done in Register 0x09 and Register 0x0A, with the default being that all LEDs are part of the backlight.

Each group has its own fade-in and fade-out times (Register 0x12 for backlight and Register 0x22 for ISCs). Each group also has its own master enable located in Register 0x01. However, this master enable is overwritten if any of the SCx_EN bits (Register 0x1A and Register 0x1B) in a group are set high. This allows complete independent control of each LED channel in both groups.

OUTPUT CURRENT SETTINGS

The current setting is determined by a 7-bit code programmed by the user into diode current control registers (Register 0x13 for the backlight and Register 0x23 to Register 0x2B for the independent sinks). The 7-bit resolution allows the user to set the backlight to one of 128 different levels between 0 mA and 25 mA. The ADP8866 implements a square law algorithm to achieve a nonlinear relationship between input code and backlight current. The LED output current (in milliamperes) is determined by the following equation:

$$LED_Current(mA) = \left(Code \times \frac{\sqrt{Full - Scale Current}}{127} \right)^2 \quad (2)$$

where:

Code is the input code programmed by the user.

Full-Scale Current is the maximum sink current allowed per LED.

OUTPUT CURRENT RANGE SELECTION

The default maximum current range of each sink of the ADP8866 is 25.0 mA (typical). However, the ADP8866 also allows the user to select an alternative maximum current range to be applied to one or more LEDs. This alternate current range still has 128 codes for its current setting. This provides improved resolution when operating at reduced maximum currents. One of up to 60 alternate current ranges can be selected. An example of some of the available current ranges is shown below. For the complete list, see Table 23.

Table 5. Example Current Range Options in Register 0x07

LEVEL_SET Code	Range
000010	25.00 mA
001100	12.50 mA
010110	8.33 mA
100000	6.25 mA
101010	5.00 mA

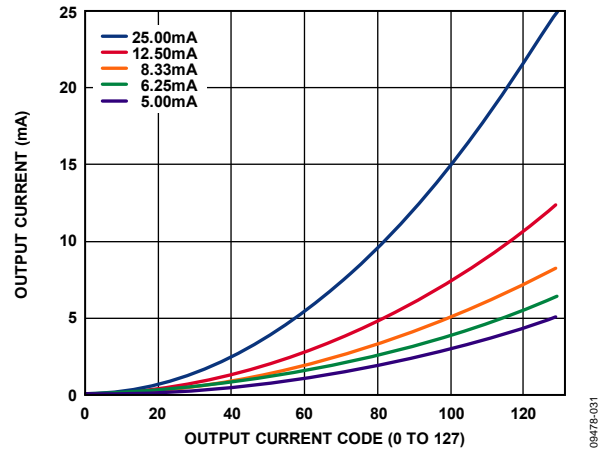

Figure 30. Output Code Effect on Various LEVEL_SET Ranges

The LEDs that receive this alternate current range are determined by the DxLVL bits in Register 0x07 and Register 0x08.

PWM DIMMING

Setting the LEVEL_SET code to 111111 (binary) allows the ADP8866 to dim its LEDs based on a PWM signal applied to the nINT pin. The LED output current is pulse width modulated with the signal applied to the nINT pin. The typical waveform and timing are shown in Figure 29. Due to the inherent delays and rise/fall times of this system, the best accuracy of the average output current is obtained with PWM frequencies below 1 kHz.

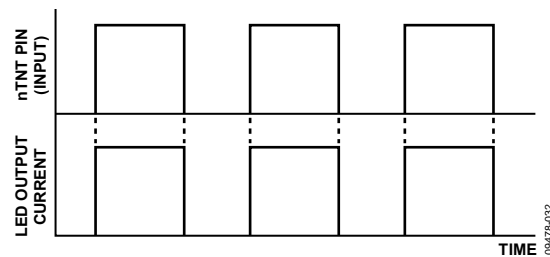

Figure 31. PWM Input Waveform and Resultant LED Current

In this mode, the nINT pin functions as an input. It no longer provides notification of the INT_STAT register.

AUTOMATED FADE-IN AND FADE-OUT

The LED drivers are easily configured for automated fade-in and fade-out. Sixteen fade-in and fade-out rates can be selected via the I²C interface. Fade-in and fade-out rates range from 0.0 sec to 1.75 sec (per full-scale current). Separate fade times are assigned to the backlight LEDs and the ISC LEDs (see the LED Groups section). The BLOFF_INT bit in Register 0x02 can be used to flag the interrupt pin when an automated backlight fade-out has occurred.

The fade profile is based on the transfer law selected (square, Cubic 10, or Cubic 11) and the delta between the actual current and the target current. Smaller changes in current reduce the fade time. For square law fades, the fade time is given by

$$\text{Fade Time} = \text{Fade Rate} \times (\text{Code}/127) \tag{4}$$

where the *Fade Rate* is shown in Table 6.

Table 6. Available Fade-In and Fade-Out Times

Code	Fade Rate (Seconds per 128 Codes)
0000	0.0
0001	0.05
0010	0.10
0011	0.15
0100	0.20
0101	0.25
0110	0.30
0111	0.35
1000	0.40
1001	0.45
1010	0.50
1011	0.75
1100	1.0
1101	1.25
1110	1.50
1111	1.75

The Cubic 10 and Cubic 11 laws also use the square backlight currents in Equation 3; however, the time between each step is varied to produce a steeper slope at higher currents and a shallower slope at lighter currents (see Figure 32).

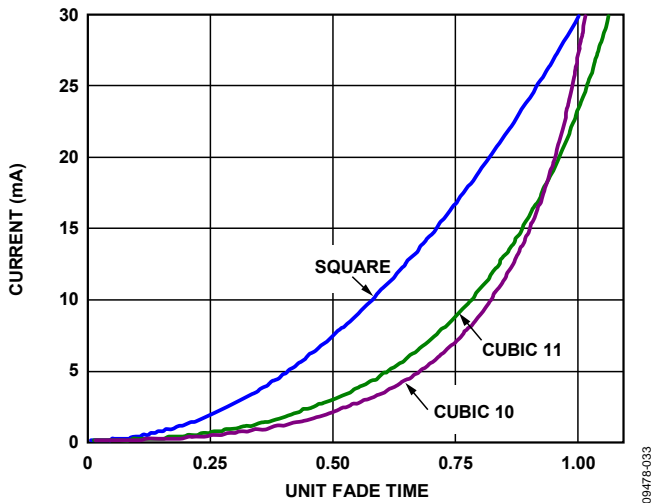

Figure 32. Comparison of the Dimming Transfers Law 25 mA Scale Shown

CABC FADE DISABLE

The fade settings applied to the backlight in Register 0x12 are also used when the BLMX (Register 0x13) current is changed. This provides a smooth transition to new backlight current levels.

However, in some modes of operation, this feature is not desired. For example, during cABC (content adjustable

brightness control) operation, the BLMX register is updated as often as 60 times per second. And the changes to BLMX must be implemented as soon as possible. Therefore, the ADP8866 has a unique mode that allows the backlight to have very fast changes after the initial ramp in and ramp out. This mode is entered when CABCFADE in Register 0x10 is set high.

In this mode, the backlight fades in when BL_EN and nSTBY in Register 0x01 are set high, and it fades out when BL_EN or nSTBY is set low. However, after the fade-in is complete, any changes to the BLMX register result in near instantaneous changes to the backlight current. The situation is illustrated in Figure 33.

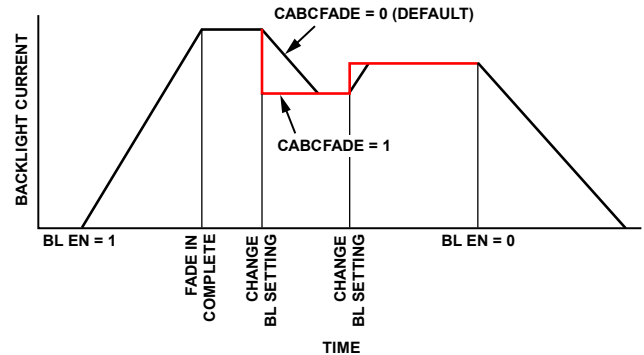

Figure 33. Effect of the CABCFADE Bit

INDEPENDENT SINK CONTROL (ISC)

Each of the nine LEDs can be configured (in Register 0x10 and Register 0x11) to operate as either part of the backlight or an independent sink current (ISC). Each ISC can be enabled independently and has its own current level. All ISCs share the same fade-in rates, fade-out rates, and fade law.

The ISCs have additional timers to facilitate blinking functions. A shared on timer (SCON), used in conjunction with the off timers of each ISC (SC1OFF, SC2OFF, SC3OFF, SC4OFF, SC5OFF, SC6OFF, and SC7OFF; see Register 0x1C through Register 0x21) allow the LED current sinks to be configured in various blinking modes. The on and off times are listed in the Register Descriptions section. Blink mode is activated by setting the off timers to any setting other than disabled.

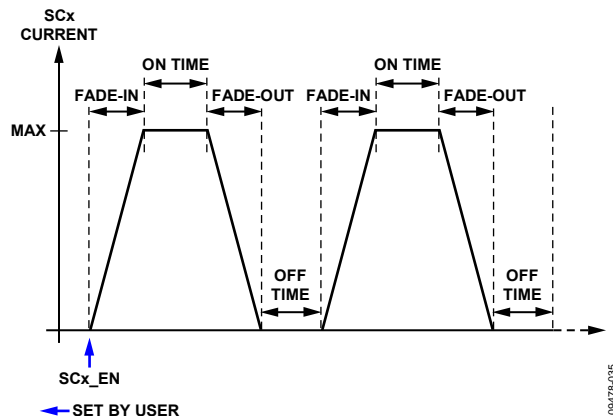

Figure 34. LEDx Blink Mode with Fading

Program all fade-in and fade-out timers before enabling any of the LED current sinks. If ISC_x is on during a blink cycle and SC_x_EN in Register 0x1B is cleared, it turns off (or fades to off if fade-out is enabled). If ISC_x is off during a blink cycle and SC_x_EN is cleared, it stays off.

ADVANCED BLINKING CONTROLS

Diode D1 to Diode D5 have basic blinking controls, while Channel D6 to Channel D9 have much more advanced capabilities. These advanced features include

- Programmable delays: Register 0x3C to Register 0x3F set the individual delays for D6 to D9. Delays are activated when the individual diode is enabled. Delay times range from 0 sec to 1.270 sec in 10 ms increments.

- Additional off time selections: D6 to D9 off times that range from 0 sec to 12.5 sec in 100 ms increments (Register 0x1E to Register 0x21). The off times can also be set to off, which turns the channel off at the completion of the blink cycle. The LED turns on again when the enable signal is toggled.
- Heartbeat mode: This mode allows a double pulse to be issued in a fully automated and customizable loop. Register 0x2C through Register 0x35 control the heartbeat effect. Up to four channels (D6 to D9) can be configured to operate in the heartbeat mode. The approximate shape of the heartbeat is shown in Figure 35:

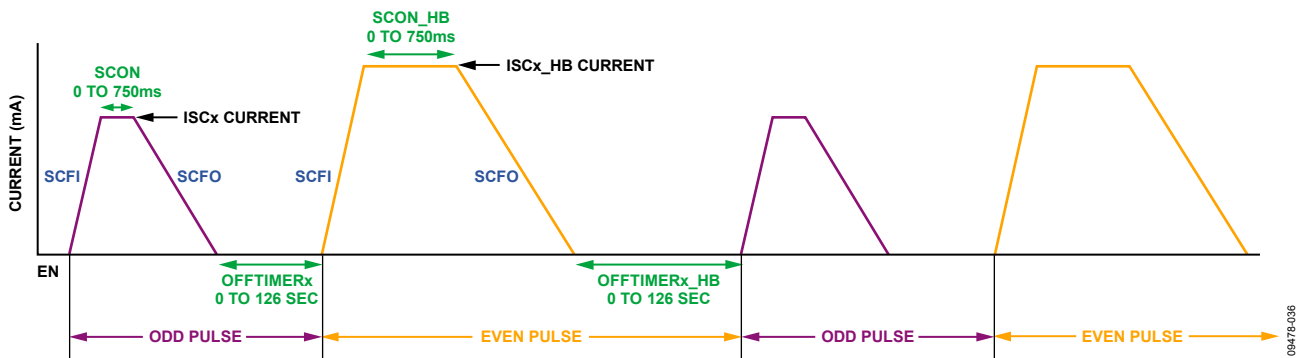

Figure 35. Customizable Heartbeat Pulse

SHORT-CIRCUIT PROTECTION (SCP) MODE

The ADP8866 can protect against short circuits on the output (V_{OUT}). Short-circuit protection (SCP) is activated at the point when $V_{OUT} < 55\%$ of V_{IN} . Note that this SCP sensing is disabled during startup and restart attempts (fault recovery). SCP sensing is reenabled 4 ms (typical) after activation. During a short-circuit fault, the device enters a low current consumption state and an interrupt flag is set. The device can be restarted at any time after receiving a short-circuit fault by simply rewriting $nSTBY = 1$ in Register 0x01. It then repeats another complete soft start sequence. Note that the value of the output capacitance (C_{OUT}) should be small enough to allow V_{OUT} to reach approximately 55% (typical) of V_{IN} within the 4 ms (typical) time. If C_{OUT} is too large, the device inadvertently enters short-circuit protection.

OVERVOLTAGE PROTECTION (OVP)

Overvoltage protection is implemented on the VOUT pin. There are two types of overvoltage events: normal (no fault) and abnormal.

Normal (No Fault) Overvoltage

In this case, the VOUT pin voltage approaches $V_{OUT(REG)}$ (4.9 V typical) during normal operation. This is not caused by a fault or load change but is simply a consequence of the input voltage times the gain reaching the clamped output voltage $V_{OUT(REG)}$. To prevent this, the ADP8866 detects when the output voltage rises to $V_{OUT(REG)}$. It then increases the effective R_{OUT} of the gain stage to reduce the voltage that is delivered. This effectively regulates V_{OUT} to $V_{OUT(REG)}$; however, there is a limit to the effect that this system can have on regulating V_{OUT} . It is designed only for normal operation and is not intended to protect against faults or sudden load changes. During this mode, no interrupt is set, and the operation is transparent to the LEDs and overall application.

The automatic gain selection equations take into account the additional drop within R_{OUT} to maintain optimum efficiency.

Abnormal (Fault/Sudden Load Change) Overvoltage

Because of the open loop behavior of the charge pump, as well as how the gain transitions are computed, a sudden load change or fault can abnormally force V_{OUT} beyond 6 V. If the event happens slowly enough, the system first tries to regulate the output to 4.9 V as in a normal overvoltage scenario. However, if this is not sufficient, or if the event happens too quickly, the ADP8866 enters overvoltage protection mode when V_{OUT} exceeds the OVP threshold (typically 5.7 V). In this mode, only the charge pump is disabled to prevent V_{OUT} from rising too high. The current sources and all other device functionality remain intact. When the output voltage falls by about 500 mV (to 5.2 V typical), the charge pump resumes operation. If the fault or load step recurs, the process may repeat. An interrupt flag is set at each OVP instance.

THERMAL SHUTDOWN (TSD)/OVERTEMPERATURE PROTECTION

If the die temperature of the ADP8866 rises above a safety limit (150°C typical), the controllers enter TSD protection mode. In this mode, most of the internal functions are shut down, the part enters standby, and the TSD_INT interrupt is set (see Register 0x02). When the die temperature decreases below ~130°C, the part is allowed to be restarted. To restart the part, simply remove it from standby. No interrupt is generated when the die temperature falls below 130°C. However, if the software clears the pending TSD_INT interrupt and the temperature remains above 130°C, another interrupt is generated.

The complete state machine for these faults (SCP, OVP, and TSD) is shown in Figure 36.

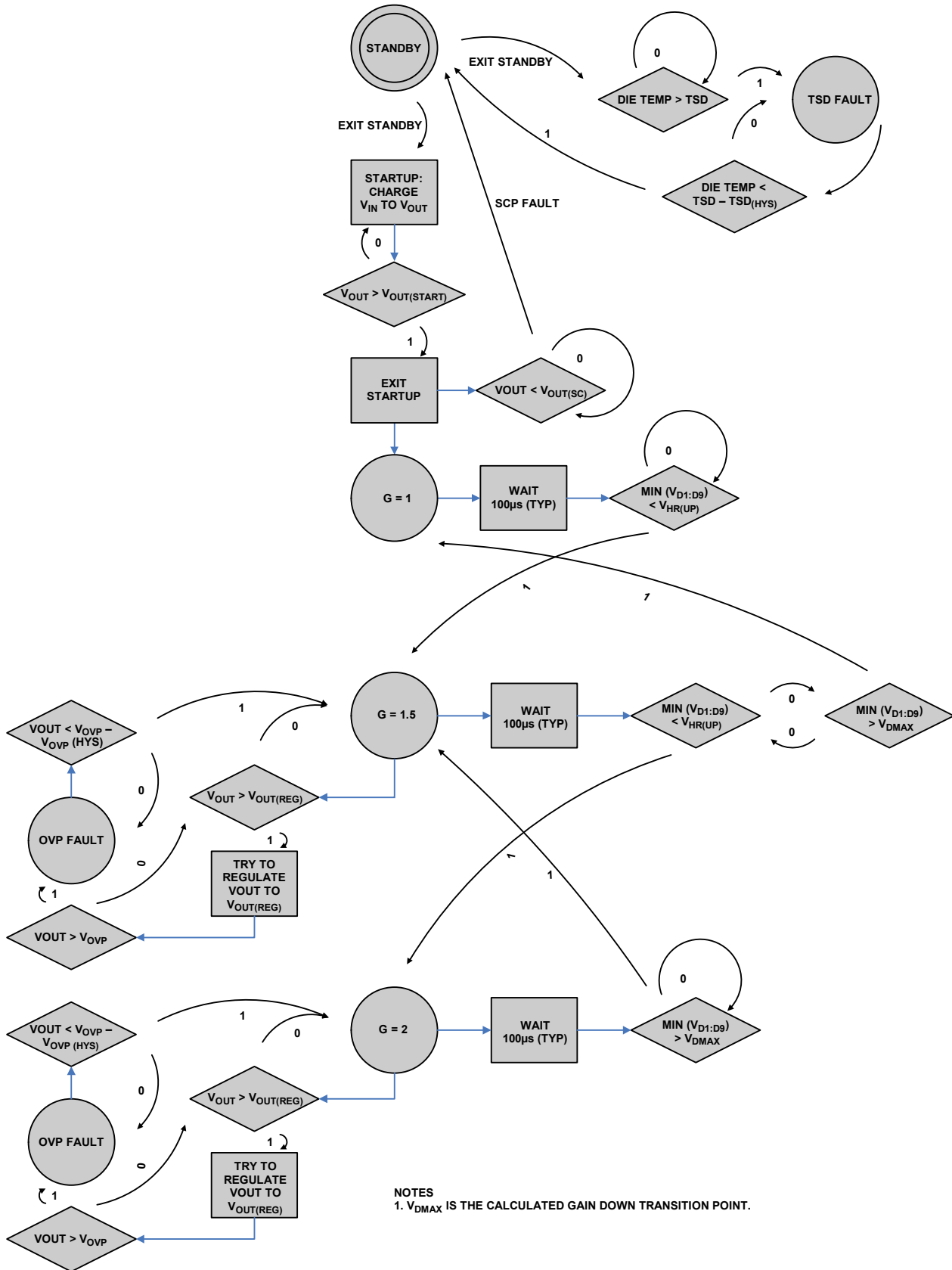

Figure 36. Fault State Machine

INTERRUPTS

There are four interrupt sources available on the ADP8866.

- Independent sink off: when all independent sinks that are assigned with the DxOFFINT bits high in Register 0x04 and Register 0x05 have faded to off, this interrupt (ISCOFF_INT, Register 0x02) is set.
- Backlight off: at the end of each automated backlight fade-out, this interrupt (BLOFF_INT, Register 0x02) is set.
- Overvoltage protection: OVP_INT (see Register 0x02) is generated when the output voltage exceeds 5.7 V (typical).
- Thermal shutdown circuit: an interrupt (TSD_INT, Register 0x02) is generated when entering overtemperature protection.
- Short-circuit detection: SHORT_INT (see Register 0x02) is generated when the device enters short-circuit protection mode.

The interrupt (if any) that appears on the nINT pin is determined by the bits mapped in Register INT_EN, 0x03. To clear an interrupt, write a 1 to the interrupt in the INT_STAT register, 0x02, or reset the part.

BACKLIGHT OFF INTERRUPT

The backlight off interrupt (BLOFF_INT) is set when the backlight completes a fade-out. This feature is useful to synchronize the backlight turn off with the LCD display driver.

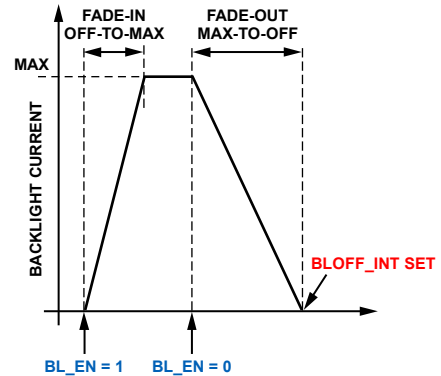

Figure 37. Backlight Off Interrupt Timing Diagram

INDEPENDENT SINK OFF INTERRUPT

The independent sink off interrupt (ISCOFF_INT) is generated when all the independent sinks assigned in Register 0x04 and Register 0x05 have faded to off. This can happen during a blinking profile (where SCxOFF does not equal disabled) or when an ISC is disabled. Note that even with fade-out set to 0, an ISCOFF_INT is still set.

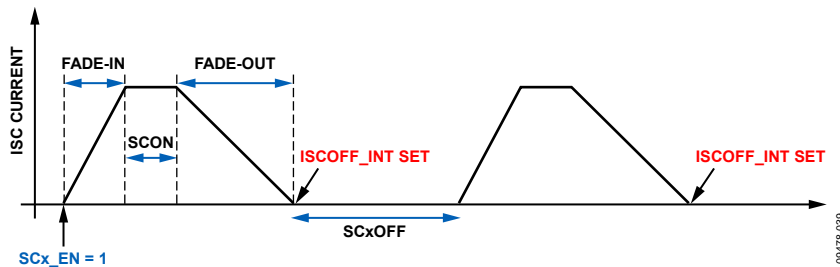

Figure 38. Independent Sink Off Interrupt Timing Diagram

APPLICATIONS INFORMATION

The ADP8866 allows the charge pump to operate efficiently with a minimum of external components. Specifically, the user must select an input capacitor (C_{IN}), output capacitor (C_{OUT}), and two charge pump fly capacitors ($C1$ and $C2$). C_{IN} should be 1 μ F or greater. The value must be high enough to produce a stable input voltage signal at the minimum input voltage and maximum output load. A 1 μ F capacitor for C_{OUT} is recommended. Larger values are permissible, but care must be exercised to ensure that V_{OUT} charges above 55% (typical) of V_{IN} within 4 ms (typical). See the Short-Circuit Protection (SCP) Mode section for more detail.

For best practice, it is recommended that the two charge pump fly capacitors be 1 μ F; larger values are not recommended and smaller values may reduce the ability of the charge pump to deliver maximum current. For optimal efficiency, the charge pump fly capacitors should have low equivalent series resistance (ESR). Low ESR X5R or X7R capacitors are recommended for all four components. Minimum voltage ratings should adhere to the guidelines in Table 7:

Table 7. Capacitor Stress in Each Charge Pump Gain State

Capacitor	Gain = 1 \times	Gain = 1.5 \times	Gain = 2 \times
C_{IN} (Input Capacitor)	V_{IN}	V_{IN}	V_{IN}
C_{OUT} (Output Capacitor)	V_{IN}	$V_{IN} \times 1.5$ (Max of 5.5 V)	$V_{IN} \times 2.0$ (Max of 5.5 V)
$C1$ (Charge Pump Capacitor)	None	$V_{IN} \div 2$	V_{IN}
$C2$ (Charge Pump Capacitor)	None	$V_{IN} \div 2$	V_{IN}

Any color LED can be used provided that the V_f (forward voltage) is less than 4.3 V. However, using lower V_f LEDs reduces the input power consumption by allowing the charge pump to operate at lower gain states.

The equivalent model for a charge pump is shown in Figure 39.

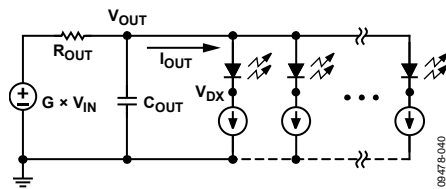

Figure 39. Charge Pump Equivalent Circuit Model

The input voltage is multiplied by the gain (G) and delivered to the output through an effective charge pump resistance (R_{OUT}). The output current flows through R_{OUT} and produces an IR drop, which yields

$$V_{OUT} = G \times V_{IN} - I_{OUT} \times R_{OUT}(G) \quad (6)$$

The R_{OUT} term is a combination of the $R_{DS(ON)}$ resistance for the switches used in the charge pump and a small resistance that accounts for the effective dynamic charge pump resistance. The R_{OUT} level changes based upon the gain (the configuration of the

switches). Typical R_{OUT} values are given in Table 1 and Figure 14 and Figure 16.

V_{OUT} is also equal to the largest V_f of the LEDs used plus the voltage drop across the regulating current source. This gives

$$V_{OUT} = V_{f(MAX)} + V_{DX} \quad (7)$$

Combining Equation 6 and Equation 7 gives

$$V_{IN} = (V_{f(MAX)} + V_{DX} + I_{OUT} \times R_{OUT}(G))/G \quad (8)$$

This equation is useful for calculating approximate bounds for the charge pump design.

Determining the Transition Point of the Charge Pump

Consider the following design example where:

$$V_{f(MAX)} = 3.7 \text{ V}$$

$$I_{OUT} = 140 \text{ mA (7 LEDs at 20 mA each)}$$

$$R_{OUT}(G = 1.5\times) = 3 \Omega \text{ (obtained from Figure 12)}$$

At the point of a gain transition, $V_{DX} = V_{HR(UP)}$. Table 1 gives the typical value of $V_{HR(UP)}$ as 0.2 V. Therefore, the input voltage level when the gain transitions from 1.5 \times to 2 \times is

$$V_{IN} = (3.7 \text{ V} + 0.2 \text{ V} + 140 \text{ mA} \times 3 \Omega)/1.5 = 2.88 \text{ V}$$

LAYOUT GUIDELINES

- For optimal noise immunity, place the C_{IN} and C_{OUT} capacitors as close to their respective pins as possible. These capacitors should share a short ground trace. If the LEDs are a significant distance from the V_{OUT} pin, another capacitor on V_{OUT} , placed closer to the LEDs, is advisable.
- For optimal efficiency, place the charge pump fly capacitors as close to the part as possible.
- The ground pin should be connected at the ground for the input and output capacitors. The LFCSP exposed pad must be soldered at the board to the GND pin.
- Unused diode pins [D1:D9] can be connected to ground or V_{OUT} or remain floating. However, the unused diode current sinks must be removed from the charge pump gain calculation by setting the appropriate $DxPWR$ bits high in Register 0x09 and Register 0x0A.
- If the interrupt pin ($nINT$) is not used, connect it to ground or leave it floating. Never connect it to a voltage supply, except through a $\geq 1 \text{ k}\Omega$ series resistor.
- The ADP8866 has an integrated noise filter on the $nRST$ pin. Under normal conditions, it is not necessary to filter the reset line. However, if exposed to an unusually noisy signal, it is beneficial to add a small RC filter or bypass capacitor on this pin. If the $nRST$ pin is not used, it must be pulled well above the $V_{IH(MAX)}$ level (see Table 1). Do not allow the $nRST$ pin to float.

I²C PROGRAMMING AND DIGITAL CONTROL

The ADP8866 provides full software programmability to facilitate its adoption in various product architectures. The I²C address is 0100111x (x = 0 during write, x = 1 during read). Therefore, the write address is 0x4E, and the read address is 0x4F.

Notes on the general behavior of registers:

- All registers are set to default values on reset or in case of a UVLO event.

- All registers are read/write unless otherwise specified
- Unused bits are read-as-zero.

Table 8 through Table 103 provide register and bit descriptions. The reset value for all bits in the bit map tables is all 0s, except in Table 9 (see Table 9 for its unique reset value). Wherever the acronym N/A appears in the tables, it means not applicable.

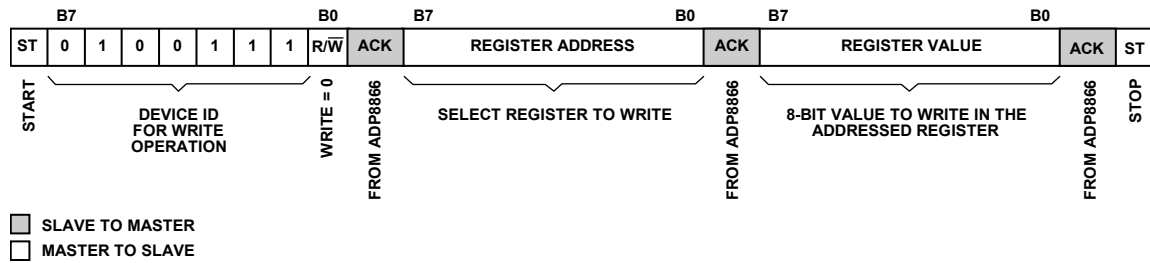

Figure 40. I²C Write Sequence

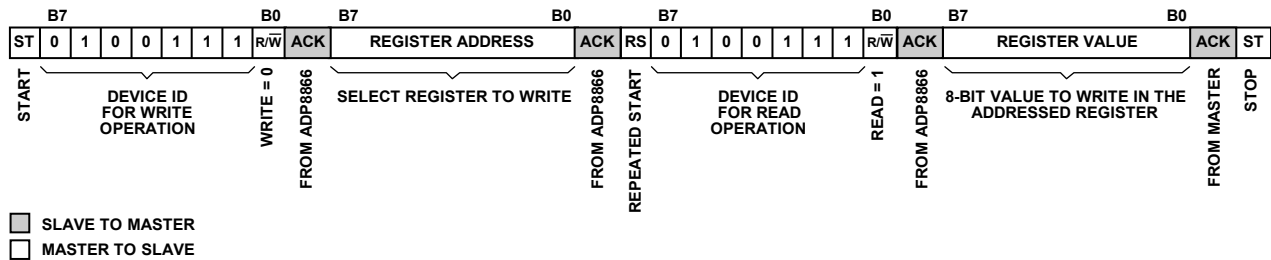

Figure 41. I²C Read Sequence

REGISTER DESCRIPTIONS

Table 8. Register Map

Address	Name	Bit 7	Bit 6	Bit 5	Bit 4	Bit 3	Bit 2	Bit 1	Bit 0	
0x00	MFDVID	Manufacture ID				Device ID				
0x01	MDCR	Reserved	INT_CFG	NSTBY	ALT_GSEL	GDWN_DIS	SIS_EN	Reserved	BL_EN	
0x02	INT_STAT	Reserved	ISCOFF_INT	BLOFF_INT	SHORT_INT	TSD_INT	OVP_INT	Reserved	Reserved	
0x03	INT_EN	Reserved	ISCOFF_IEN	BLOFF_IEN	SHORT_IEN	TSD_IEN	OVP_IEN	Reserved	Reserved	
0x04	ISCOFF_SEL1	Reserved							D9OFFINT	
0x05	ISCOFF_SEL2	D8OFFINT	D7OFFINT	D6OFFINT	D5OFFINT	D4OFFINT	D3OFFINT	D2OFFINT	D1OFFINT	
0x06	GAIN_SEL	Reserved					1.5X_LIMIT	G_FORCE		
0x07	LVL_SEL1	Reserved	D9LVL	LEVEL_SET						
0x08	LVL_SEL2	D8LVL	D7LVL	D6LVL	D5LVL	D4LVL	D3LVL	D2LVL	D1LVL	
0x09	PWR_SEL1	Reserved							D9PWR	
0x0A	PWR_SEL2	D8PWR	D7PWR	D6PWR	D5PWR	D4PWR	D3PWR	D2PWR	D1PWR	
0x0B to 0x0F	Reserved	Reserved								
0x10	CFGR	Reserved			D9SEL	CABCFADE	BL_LAW		Reserved	
0x11	BLSEL	D8SEL	D7SEL	D6SEL	D5SEL	D4SEL	D3SEL	D2SEL	D1SEL	
0x12	BLFR	BL_FO				BL_FI				
0x13	BLMX	Reserved	BL_MC							
0x14 to 0x19	Reserved	Reserved								
0x1A	ISCC1	Reserved					SC9_EN	SC_LAW		
0x1B	ISCC2	SC8_EN	SC7_EN	SC6_EN	SC5_EN	SC4_EN	SC3_EN	SC2_EN	SC1_EN	
0x1C	ISCT1	SCON				Reserved			SC5OFF	
0x1D	ISCT2	SC4OFF		SC3OFF		SC2OFF		SC1OFF		
0x1E	OFFTIMER6	Reserved	SC6OFF							
0x1F	OFFTIMER7	Reserved	SC7OFF							
0x20	OFFTIMER8	Reserved	SC8OFF							
0x21	OFFTIMER9	Reserved	SC9OFF							
0x22	ISCF	SCFO				SCFI				
0x23	ISC1	Reserved	SCD1							
0x24	ISC2	Reserved	SCD2							
0x25	ISC3	Reserved	SCD3							
0x26	ISC4	Reserved	SCD4							
0x27	ISC5	Reserved	SCD5							
0x28	ISC6	Reserved	SCD6							
0x29	ISC7	Reserved	SCD7							
0x2A	ISC8	Reserved	SCD8							
0x2B	ISC9	Reserved	SCD9							
0x2C	HB_SEL	Reserved				D9HB_EN	D8HB_EN	D7HB_EN	D6HB_EN	
0x2D	ISC6_HB	Reserved	SCD6_HB							
0x2E	ISC7_HB	Reserved	SCD7_HB							
0x2F	ISC8_HB	Reserved	SCD8_HB							
0x30	ISC9_HB	Reserved	SCD9_HB							
0x31	OFFTIMER6_HB	Reserved	SC6OFF_HB							
0x32	OFFTIMER7_HB	Reserved	SC7OFF_HB							
0x33	OFFTIMER8_HB	Reserved	SC8OFF_HB							
0x34	OFFTIMER9_HB	Reserved	SC9OFF_HB							
0x35	ISCT_HB	Reserved				SCON_HB				
0x36 to 0x3B	Reserved	Reserved								
0x3C	DELAY6	Reserved	DELAY6							
0x3D	DELAY7	Reserved	DELAY7							
0x3E	DELAY8	Reserved	DELAY8							
0x3F	DELAY9	Reserved	DELAY9							

Manufacturer and Device ID (MFDVID)—Register 0x00

Multiple device revisions are tracked by the device ID field. This is a read-only register.

Table 9. MFDVID Manufacturer and Device ID Bit Map

Bit 7	Bit 6	Bit 5	Bit 4	Bit 3	Bit 2	Bit 1	Bit 0
Manufacture ID				Device ID			
0	1	0	1	0	0	1	1

Mode Control Register (MDCR)—Register 0x01**Table 10. MDCR Bit Map**

Bit 7	Bit 6	Bit 5	Bit 4	Bit 3	Bit 2	Bit 1	Bit 0
Reserved	INT_CFG	NSTBY	ALT_GSEL	GDWN_DIS	SIS_EN	Reserved	BL_EN

Table 11.

Bit Name	Bit No.	Description
N/A	7	Reserved.
INT_CFG	6	Interrupt configuration. 1 = processor interrupt deasserts for 50 μ s and reasserts with pending events. 0 = processor interrupt remains asserted if the host tries to clear the interrupt while there is a pending event.
NSTBY	5	1 = device is in normal mode. 0 = device is in standby, only I ² C is enabled.
ALT_GSEL	4	1 = charge pump gain is automatically set to 1 \times every time that the BLMX (Register 0x13) is written to. 0 = writing to BLMX (Register 13) has no unique effect on the charge pump gain.
GDWN_DIS	3	1 = the charge pump does not switch down in gain until all LEDs are off. The charge pump switches up in gain as needed. This feature is useful if the ADP8866 charge pump is used to drive an external load. 0 = the charge pump automatically switches up and down in gain. This provides optimal efficiency but is not suitable for driving external loads (other than those connected to the ADP8866 diode drivers).
SIS_EN	2	Master enable for independent sinks. 1 = enables all LED current sinks designated as independent sinks. This bit has no effect if any of the SCx_EN bits that are part of the independent sinks group in Register 0x1A and Register 0x1B are set. 0 = disables all sinks designated as independent sinks. This bit has no effect if any of the SCx_EN bits that are part of the independent sinks group in Register 0x1A and Register 0x1B are set.
N/A	1	Reserved.
BL_EN	0	Master enable for backlight sinks. 1 = enables all LED current sinks designated as backlight. 0 = disables all sinks designated as backlight.

Interrupt Status Register (INT_STAT)—Register 0x02

Table 12. INT_STAT Bit Map

Bit 7	Bit 6	Bit 5	Bit 4	Bit 3	Bit 2	Bit 1	Bit 0
Reserved	ISCOFF_INT	BLOFF_INT	SHORT_INT	TSD_INT	OVP_INT	Reserved	

Table 13.

Bit Name	Bit No.	Description ¹
N/A	7	Reserved.
ISCOFF_INT	6	Independent sink off. 1 = indicates that the controller has ramped all the independent sinks designated in Register 0x04 and Register 0x05 to off. 0 = the controller has not ramped all designated independent sinks to off.
BLOFF_INT	5	Backlight off. 1 = indicates that the controller has faded the backlight sinks to off. 0 = the controller has not completed fading the backlight sinks to off.
SHORT_INT	4	Short-circuit error. 1 = a short-circuit or overload condition on VOUT or current sinks was detected. 0 = no short-circuit or overload condition was detected.
TSD_INT	3	Thermal shutdown. 1 = device temperature is too high and has been shut down. 0 = no overtemperature condition was detected.
OVP_INT	2	Overvoltage interrupt. 1 = charge-pump output voltage has exceeded V_{OVP} . 0 = charge-pump output voltage has not exceeded V_{OVP} .
N/A	[1:0]	Reserved.

¹ Interrupt bits are cleared by writing a 1 to the flag; writing a 0 or reading the flag has no effect.

Interrupt Enable (INT_EN)—Register 0x03

Table 14. INT_EN Bit Map

Bit 7	Bit 6	Bit 5	Bit 4	Bit 3	Bit 2	Bit 1	Bit 0
Reserved	ISCOFF_IEN	BLOFF_IEN	SHORT_IEN	TSD_IEN	OVP_IEN	Reserved	

Table 15.

Bit Name	Bit No.	Description
N/A	7	Reserved.
ISCOFF_IEN	6	Automated ISC off indicator. 1 = the automated independent sink off indicator is enabled. 0 = the automated independent sink off indicator is disabled.
BLOFF_IEN	5	Automated backlight off indicator. 1 = the automated backlight off indicator is enabled. 0 = the automated backlight off indicator is disabled. When this bit is set, an INT is generated anytime that a backlight fade-out is over. This occurs after an automated fade-out or after the completion of a backlight dimming profile. This is useful to synchronize the complete turn off for the backlights with other devices in the application.
SHORT_IEN	4	Short-circuit interrupt enabled. When the SHORT_INT status bit is set after an error condition, an interrupt is raised to the host if the SHORT_IEN flag is enabled. 1 = the short-circuit interrupt is enabled. 0 = the short-circuit interrupt is disabled (SHORT_INT flag is still asserted).
TSD_IEN	3	Thermal shutdown interrupt enabled. When the TSD_INT status bit is set after an error condition, an interrupt is raised to the host if the TSD_IEN flag is enabled. 1 = the thermal shutdown interrupt is enabled. 0 = the thermal shutdown interrupt is disabled (TSD_INT flag is still asserted).

Bit Name	Bit No.	Description
OVP_IEN	2	Overvoltage interrupt enabled. When the OVP_INT status bit is set after an error condition, an interrupt is raised to the host if the OVP_IEN flag is enabled. 1 = the overvoltage interrupt is enabled. 0 = the overvoltage interrupt is disabled (OVP_INT flag is still asserted).
N/A	[1:0]	Reserved.

Independent Sink Interrupt Selection 1 (ISCOFF_SEL1)—Register 0x04

Table 16. ISCOFF_SEL1 Bit Map

Bit 7	Bit 6	Bit 5	Bit 4	Bit 3	Bit 2	Bit 1	Bit 0
Reserved							D9OFFINT

Table 17.

Bit Name	Bit No.	Description
N/A	[7:1]	Reserved.
D9OFFINT	0	Include Diode 9 in the ISCOFF_INT flag. 1 = Diode 9 is in the group which triggers an ISCOFF_INT. When Diode 9 and all other LEDs with DxOFFINT are set high and go from on to off, ISCOFF_INT is set. 0 = Diode 9 is not in the group which triggers an ISCOFF_INT when all diodes in that group are off.

Independent Sink Interrupt Selection 2 (ISCOFF_SEL2)—Register 0x05

Table 18. ISCOFF_SEL2 Bit Map

Bit 7	Bit 6	Bit 5	Bit 4	Bit 3	Bit 2	Bit 1	Bit 0
D8OFFINT	D7OFFINT	D6OFFINT	D5OFFINT	D4OFFINT	D3OFFINT	D2OFFINT	D1OFFINT

Table 19.

Bit Name	Bit No.	Description
D8OFFINT	7	Include Diode 8 in the ISCOFF_INT flag. 1 = Diode 8 is in the group that triggers an ISCOFF_INT. When Diode 8 and all other LEDs with DxOFFINT are set high and goes from on to off, ISCOFF_INT is set. 0 = Diode 8 is not in the group that triggers an ISCOFF_INT when all diodes in that group are off.
D7OFFINT	6	Include Diode 7 in the ISCOFF_INT flag. 1 = Diode 7 is in the group that triggers an ISCOFF_INT. When Diode 7 and all other LEDs with DxOFFINT are set high and goes from on to off, ISCOFF_INT is set. 0 = Diode 7 is not in the group that triggers an ISCOFF_INT when all diodes in that group are off.
D6OFFINT	5	Include Diode 6 in the ISCOFF_INT flag. 1 = Diode 6 is in the group that triggers an ISCOFF_INT. When Diode 6 and all other LEDs with DxOFFINT are set high and goes from on to off, ISCOFF_INT is set. 0 = Diode 6 is not in the group that triggers an ISCOFF_INT when all diodes in that group are off.
D5OFFINT	4	Include Diode 5 in the ISCOFF_INT flag. 1 = Diode 5 is in the group that triggers an ISCOFF_INT. When Diode 5 and all other LEDs with DxOFFINT are set high and goes from on to off, ISCOFF_INT is set. 0 = Diode 5 is not in the group that triggers an ISCOFF_INT when all diodes in that group are off.
D4OFFINT	3	Include Diode 4 in the ISCOFF_INT flag. 1 = Diode 4 is in the group that triggers an ISCOFF_INT. When Diode 4 and all other LEDs with DxOFFINT are set high and goes from on to off, ISCOFF_INT is set. 0 = Diode 4 is not in the group that triggers an ISCOFF_INT when all diodes in that group are off.
D3OFFINT	2	Include Diode 3 in the ISCOFF_INT flag. 1 = Diode 3 is in the group that triggers an ISCOFF_INT. When Diode 3 and all other LEDs with DxOFFINT are set high and goes from on to off, ISCOFF_INT is set. 0 = Diode 3 is not in the group that triggers an ISCOFF_INT when all diodes in that group are off.

Bit Name	Bit No.	Description
D2OFFINT	1	Include Diode 2 in the ISCOFF_INT flag. 1 = Diode 2 is in the group that triggers an ISCOFF_INT. When Diode 2 and all other LEDs with DxOFFINT are set high and goes from on to off, ISCOFF_INT is set. 0 = Diode 2 is not in the group that triggers an ISCOFF_INT when all diodes in that group are off.
D1OFFINT	0	Include Diode 1 in the ISCOFF_INT flag. 1 = Diode 1 is in the group that triggers an ISCOFF_INT. When Diode 1 and all other LEDs with DxOFFINT are set high and goes from on to off, ISCOFF_INT is set. 0 = Diode 1 is not in the group that triggers an ISCOFF_INT when all diodes in that group are off.

Charge Pump Gain Selection (GAIN_SEL)—Register 0x06

Table 20. GAIN_SEL Bit Map

Bit 7	Bit 6	Bit 5	Bit 4	Bit 3	Bit 2	Bit 1	Bit 0
Reserved					1.5X_LIMIT	G_FORCE	

Table 21.

Bit Name	Bit No.	Description
N/A	7:3	Reserved.
1.5X_LIMIT	2	1 = gain is allowed to transition up from 1× to 1.5×. The gain is never allowed to enter 2× mode. 0 = gain is allowed to transition up from 1× to 1.5× to 2× as needed.
G_FORCE	[1:0]	Selects desired gain state. 00 = auto gain select. 01 = gain is locked into 1× mode. 10 = gain is locked into 1.5× mode. 11 = gain is locked into 2× mode (if 1.5X_LIMIT = 1, gain is locked into 1.5×)

Output Level Selection 1 (LVL_SEL1)—Register 0x07

Table 22. LVL_SEL1 Bit Map

Bit 7	Bit 6	Bit 5	Bit 4	Bit 3	Bit 2	Bit 1	Bit 0
Reserved	D9LVL	LEVEL_SET					

Table 23.

Bit Name	Bit No.	Description																								
N/A	7	Reserved.																								
D9LVL	6	Diode 9 level select. 1 = control with the LEVEL_SET bits. 0 = normal mode (25 mA full-scale current).																								
LEVEL_SET	[5:0]	Output level selection. Sets the mode of operation for all DxLVL bits that are set high.																								
		<table border="1"> <thead> <tr> <th>Code</th> <th>N</th> <th>Maximum Current Range</th> </tr> </thead> <tbody> <tr> <td>000000</td> <td>0.8</td> <td>25 mA ÷ N = 31.3 mA</td> </tr> <tr> <td>000001</td> <td>0.9</td> <td>25 mA ÷ N = 27.8 mA</td> </tr> <tr> <td>000010</td> <td>1.0</td> <td>25 mA ÷ N = 25.0 mA</td> </tr> <tr> <td>000011</td> <td>1.1</td> <td>25 mA ÷ N = 22.7 mA</td> </tr> <tr> <td>...</td> <td>...</td> <td>...</td> </tr> <tr> <td>111110</td> <td>7.0</td> <td>25 mA ÷ N = 3.6 mA</td> </tr> <tr> <td>111111</td> <td>1.0</td> <td>PWM current. In this mode, the INT pin functions as a PWM input and directly drives the selected outputs.</td> </tr> </tbody> </table>	Code	N	Maximum Current Range	000000	0.8	25 mA ÷ N = 31.3 mA	000001	0.9	25 mA ÷ N = 27.8 mA	000010	1.0	25 mA ÷ N = 25.0 mA	000011	1.1	25 mA ÷ N = 22.7 mA	111110	7.0	25 mA ÷ N = 3.6 mA	111111	1.0	PWM current. In this mode, the INT pin functions as a PWM input and directly drives the selected outputs.
		Code	N	Maximum Current Range																						
		000000	0.8	25 mA ÷ N = 31.3 mA																						
		000001	0.9	25 mA ÷ N = 27.8 mA																						
		000010	1.0	25 mA ÷ N = 25.0 mA																						
		000011	1.1	25 mA ÷ N = 22.7 mA																						
...																								
111110	7.0	25 mA ÷ N = 3.6 mA																								
111111	1.0	PWM current. In this mode, the INT pin functions as a PWM input and directly drives the selected outputs.																								

Table 24.

Code	N	Maximum Current Range (mA)	Code	N	Maximum Current Range (mA)
000000	0.8	31.3	100000	4	6.25
000001	0.9	27.8	100001	4.1	6.10
000010	1	25.0	100010	4.2	5.95
000011	1.1	22.7	100011	4.3	5.81
000100	1.2	20.8	100100	4.4	5.68
000101	1.3	19.2	100101	4.5	5.56
000110	1.4	17.9	100110	4.6	5.43
000111	1.5	16.7	100111	4.7	5.32
001000	1.6	15.6	101000	4.8	5.21
001001	1.7	14.7	101001	4.9	5.10
001010	1.8	13.9	101010	5	5.00
001011	1.9	13.2	101011	5.1	4.90
001100	2	12.5	101100	5.2	4.81
001101	2.1	11.9	101101	5.3	4.72
001110	2.2	11.4	101110	5.4	4.63
001111	2.3	10.9	101111	5.5	4.55
010000	2.4	10.4	110000	5.6	4.46
010001	2.5	10.0	110001	5.7	4.39
010010	2.6	9.62	110010	5.8	4.31
010011	2.7	9.26	110011	5.9	4.24
010100	2.8	8.93	110100	6	4.17
010101	2.9	8.62	110101	6.1	4.10
010110	3	8.33	110110	6.2	4.03
010111	3.1	8.06	110111	6.3	3.97
011000	3.2	7.81	111000	6.4	3.91
011001	3.3	7.58	111001	6.5	3.85
011010	3.4	7.35	111010	6.6	3.79
011011	3.5	7.14	111011	6.7	3.73
011100	3.6	6.94	111100	6.8	3.68
011101	3.7	6.76	111101	6.9	3.62
011110	3.8	6.58	111110	7.0	3.57
011111	3.9	6.41	111111	1.0	PWM current

Output Level Selection 2 (LVL_SEL2)—Register 0x08

Table 25. LVL_SEL2 Bit Map

Bit 7	Bit 6	Bit 5	Bit 4	Bit 3	Bit 2	Bit 1	Bit 0
D8LVL	D7LVL	D6LVL	D5LVL	D4LVL	D3LVL	D2LVL	D1LVL

Table 26.

Bit Name	Bit No.	Description
D8LVL	7	Diode 8 level select. 1 = control with the LEVEL_SET bits. 0 = normal mode (25 mA full-scale current).
D7LVL	6	Diode 7 level select. 1 = control with the LEVEL_SET bits. 0 = normal mode (25 mA full-scale current).
D6LVL	5	Diode 6 level select. 1 = control with the LEVEL_SET bits. 0 = normal mode (25 mA full-scale current).

Bit Name	Bit No.	Description
D5LVL	4	Diode 5 level select. 1 = control with the LEVEL_SET bits. 0 = normal mode (25 mA full-scale current).
D4LVL	3	Diode 4 level select. 1 = control with the LEVEL_SET bits. 0 = normal mode (25 mA full-scale current).
D3LVL	2	Diode 3 level select. 1 = control with the LEVEL_SET bits. 0 = normal mode (25 mA full-scale current).
D2LVL	1	Diode 2 level select. 1 = control with the LEVEL_SET bits. 0 = normal mode (25 mA full-scale current).
D1LVL	0	Diode 1 level select. 1 = control with the LEVEL_SET bits. 0 = normal mode (25 mA full-scale current).

LED Power Source Selection 1 (PWR_SEL1)—Register 0x09

Table 27. PWR_SEL1 Bit Map

Bit 7	Bit 6	Bit 5	Bit 4	Bit 3	Bit 2	Bit 1	Bit 0
Reserved							D9PWR

Table 28.

Bit Name	Bit No.	Description
N/A	[7:1]	Reserved.
D9PWR	0	Diode 9 LED power source select. 1 = the LED is powered from the battery or other power source. 0 = the LED is powered from the charge pump.

LED Power Source Selection 2 (PWR_SEL2)—Register 0x0A

Table 29. PWR_SEL2 Bit Map

Bit 7	Bit 6	Bit 5	Bit 4	Bit 3	Bit 2	Bit 1	Bit 0
D8PWR	D7PWR	D6PWR	D5PWR	D4PWR	D3PWR	D2PWR	D1PWR

Table 30.

Bit Name	Bit No.	Description
D8PWR	7	Diode 8 LED power source select. 1 = the LED is powered from the battery or other power source. 0 = the LED is powered from the charge pump.
D7PWR	6	Diode 7 LED power source select. 1 = the LED is powered from the battery or other power source. 0 = the LED is powered from the charge pump.
D6PWR	5	Diode 6 LED power source select. 1 = the LED is powered from the battery or other power source. 0 = the LED is powered from the charge pump.
D5PWR	4	Diode 5 LED power source select. 1 = the LED is powered from the battery or other power source. 0 = the LED is powered from the charge pump.
D4PWR	3	Diode 4 LED power source select. 1 = the LED is powered from the battery or other power source. 0 = the LED is powered from the charge pump.

Bit Name	Bit No.	Description
D3PWR	2	Diode 3 LED power source select. 1 = the LED is powered from the battery or other power source. 0 = the LED is powered from the charge pump.
D2PWR	1	Diode 2 LED power source select. 1 = the LED is powered from the battery or other power source. 0 = the LED is powered from the charge pump.
D1PWR	0	Diode 1 LED power source select. 1 = the LED is powered from the battery or other power source. 0 = the LED is powered from the charge pump.

BACKLIGHT REGISTER DESCRIPTIONS

Configuration Register (CFGR)—Register 0x10

Table 31. CFGR Bit Map

Bit 7	Bit 6	Bit 5	Bit 4	Bit 3	Bit 2	Bit 1	Bit 0
Reserved			D9SEL	CABCFADE	BL_LAW		Reserved

Table 32.

Bit Name	Bit No.	Description
N/A	[7:5]	Reserved.
D9SEL	4	Diode 9 backlight select. 1 = selects LED9 as part of the independent sinks group. 0 = selects LED9 as part of the backlight group.
CABCFADE	3	Selects how the backlight current responds to changes in its I ² C setpoint after the backlight is enabled and the fade-in is complete. 1 = any changes to the backlight current setting (Register 0x13) result in a near instant transition to the new current level. This is useful when rapid changes to the backlight current are required, such as during cABC control. 0 = any changes to the backlight current setting (Register 0x13) result in a fade to the new current level. The fade time is determined by the fade rate (set in Register 0x12) and the delta between the old and new current level.
BL_LAW	[2:1]	Backlight transfer law. 00 = square law DAC, linear time steps. 01 = square law DAC, linear time steps. 10 = square law DAC, nonlinear time steps (Cubic 10). 11 = square law DAC, nonlinear time steps (Cubic 11).
N/A	0	Reserved.

Backlight Select (BLSEL)—Register 0x11

Table 33. BLSEL Bit Map

Bit 7	Bit 6	Bit 5	Bit 4	Bit 3	Bit 2	Bit 1	Bit 0
D8SEL	D7SEL	D6SEL	D5SEL	D4SEL	D3SEL	D2SEL	D1SEL

Table 34.

Bit Name	Bit No.	Description
D8SEL	7	Diode 8 backlight select. 1 = selects LED8 as part of the independent sinks group. 0 = selects LED8 as part of the backlight group.
D7SEL	6	Diode 7 backlight select. 1 = selects LED7 as part of the independent sinks group. 0 = selects LED7 as part of the backlight group.
D6SEL	5	Diode 6 backlight select. 1 = selects LED6 as part of the independent sinks group. 0 = selects LED6 as part of the backlight group.

Bit Name	Bit No.	Description
D5SEL	4	Diode 5 backlight select. 1 = selects LED5 as part of the independent sinks group. 0 = selects LED5 as part of the backlight group.
D4SEL	3	Diode 4 backlight select. 1 = selects LED4 as part of the independent sinks group. 0 = selects LED4 as part of the backlight group.
D3SEL	2	Diode 3 backlight select. 1 = selects LED3 as part of the independent sinks group. 0 = selects LED3 as part of the backlight group.
D2SEL	1	Diode 2 backlight select. 1 = selects LED2 as part of the independent sinks group. 0 = selects LED2 as part of the backlight group.
D1SEL	0	Diode 1 backlight select. 1 = selects LED1 as part of the independent sinks group. 0 = selects LED1 as part of the backlight group.

Backlight Fade (BLFR)—Register 0x12

Table 35. BLFR Bit Map

Bit 7	Bit 6	Bit 5	Bit 4	Bit 3	Bit 2	Bit 1	Bit 0
BL_FO				BL_FI			

Table 36.

Bit Name	Bit No.	Description
BL_FO	[7:4]	Backlight fade-out rate. The backlight fades from its current value to the off value. The times listed for BL_FO are for a full-scale fade-out. Fades between closer current values reduce the fade time. See the Automated Fade-in and Fade-Out section for more information. 0000 = 0.0 sec (fade-out disabled). 0001 = 0.05 sec. 0010 = 0.10 sec. 0011 = 0.15 sec. 0100 = 0.20 sec. 0101 = 0.25 sec. 0110 = 0.30 sec. 0111 = 0.35 sec. 1000 = 0.40 sec. 1001 = 0.45 sec. 1010 = 0.50 sec. 1011 = 0.75 sec. 1100 = 1.00 sec. 1101 = 1.25 sec. 1110 = 1.50 sec. 1111 = 1.75 sec.
BL_FI	[3:0]	Backlight fade-in rate. The backlight fades from 0 to its programmed value when the backlight is turned on. The times listed for BL_FI are for a full-scale fade-in. Fades between closer current values reduce the fade time. See the Automated Fade-in and Fade-Out section for more information. 0000 = 0.0 sec (fade-in disabled). 0001 = 0.05 sec. 0010 = 0.10 sec. 0011 = 0.15 sec. ... 1111 = 1.75 sec.

Backlight Maximum Current Register (BLMX)—Register 0x13

Table 37. BLMX Bit Map

Bit 7	Bit 6	Bit 5	Bit 4	Bit 3	Bit 2	Bit 1	Bit 0
Reserved	BL_MC						

Table 38.

Bit Name	Bit No.	Description																																										
N/A	7	Reserved.																																										
BL_MC	[6:0]	Backlight maximum current. The backlight maximum current can be set according to the square law function. All values scale with the setting of LEVEL_SET. See Table 39 for a complete list of values.																																										
		<table border="1"> <thead> <tr> <th>DAC Code</th> <th>Current (mA) (Full Scale = 25 mA) LEVEL_SET = 000010</th> <th>Current (mA) (Full Scale = 12.5 mA) LEVEL_SET = 001100</th> <th>Current (mA) (Full Scale = 8.25 mA) LEVEL_SET = 010110</th> <th>Current (mA) (Full Scale = 6.25 mA) LEVEL_SET = 100000</th> <th>Current (mA) (Full Scale = 5.0 mA) LEVEL_SET = 101010</th> </tr> </thead> <tbody> <tr> <td>0x00</td> <td>0.0</td> <td>0.0</td> <td>0.0</td> <td>0.0</td> <td>0.0</td> </tr> <tr> <td>0x01</td> <td>0.0016</td> <td>0.0008</td> <td>0.0005</td> <td>0.0004</td> <td>0.0003</td> </tr> <tr> <td>0x02</td> <td>0.0062</td> <td>0.0031</td> <td>0.0021</td> <td>0.0016</td> <td>0.0012</td> </tr> <tr> <td>0x03</td> <td>0.014</td> <td>0.0070</td> <td>0.0047</td> <td>0.0035</td> <td>0.0028</td> </tr> <tr> <td>...</td> <td>...</td> <td>...</td> <td>...</td> <td>...</td> <td>...</td> </tr> <tr> <td>0x7F</td> <td>25.0</td> <td>12.5</td> <td>8.33</td> <td>6.25</td> <td>5.0</td> </tr> </tbody> </table>	DAC Code	Current (mA) (Full Scale = 25 mA) LEVEL_SET = 000010	Current (mA) (Full Scale = 12.5 mA) LEVEL_SET = 001100	Current (mA) (Full Scale = 8.25 mA) LEVEL_SET = 010110	Current (mA) (Full Scale = 6.25 mA) LEVEL_SET = 100000	Current (mA) (Full Scale = 5.0 mA) LEVEL_SET = 101010	0x00	0.0	0.0	0.0	0.0	0.0	0x01	0.0016	0.0008	0.0005	0.0004	0.0003	0x02	0.0062	0.0031	0.0021	0.0016	0.0012	0x03	0.014	0.0070	0.0047	0.0035	0.0028	0x7F	25.0	12.5	8.33	6.25	5.0
		DAC Code	Current (mA) (Full Scale = 25 mA) LEVEL_SET = 000010	Current (mA) (Full Scale = 12.5 mA) LEVEL_SET = 001100	Current (mA) (Full Scale = 8.25 mA) LEVEL_SET = 010110	Current (mA) (Full Scale = 6.25 mA) LEVEL_SET = 100000	Current (mA) (Full Scale = 5.0 mA) LEVEL_SET = 101010																																					
		0x00	0.0	0.0	0.0	0.0	0.0																																					
		0x01	0.0016	0.0008	0.0005	0.0004	0.0003																																					
		0x02	0.0062	0.0031	0.0021	0.0016	0.0012																																					
		0x03	0.014	0.0070	0.0047	0.0035	0.0028																																					
...																																							
0x7F	25.0	12.5	8.33	6.25	5.0																																							

Table 39. Diode Output Currents per DAC Code

DAC Code	Current (mA) (Full Scale = 25 mA) LEVEL_SET = 000010	Current (mA) (Full Scale = 12.5 mA) LEVEL_SET = 001100	Current (mA) (Full Scale = 8.25 mA) LEVEL_SET = 010110	Current (mA) (Full Scale = 6.25 mA) LEVEL_SET = 100000	Current (mA) (Full Scale = 5.0 mA) LEVEL_SET = 101010
0x00	0.0	0.0	0.0	0.0	0.0
0x01	0.0016	0.0008	0.0005	0.0004	0.0003
0x02	0.0062	0.0031	0.0021	0.0016	0.0012
0x03	0.014	0.0070	0.0047	0.0035	0.0028
0x04	0.025	0.012	0.0083	0.0062	0.0050
0x05	0.039	0.019	0.013	0.010	0.0078
0x06	0.056	0.028	0.019	0.014	0.011
0x07	0.076	0.038	0.025	0.019	0.015
0x08	0.099	0.050	0.033	0.025	0.020
0x09	0.126	0.063	0.042	0.031	0.025
0x0A	0.155	0.078	0.052	0.039	0.031
0x0B	0.188	0.094	0.063	0.047	0.038
0x0C	0.223	0.112	0.074	0.056	0.045
0x0D	0.262	0.131	0.087	0.065	0.052
0x0E	0.304	0.152	0.101	0.076	0.061
0x0F	0.349	0.174	0.116	0.087	0.070
0x10	0.397	0.198	0.132	0.099	0.079
0x11	0.448	0.224	0.149	0.112	0.090
0x12	0.502	0.251	0.167	0.126	0.100
0x13	0.560	0.280	0.187	0.140	0.112
0x14	0.620	0.310	0.207	0.155	0.124
0x15	0.684	0.342	0.228	0.171	0.137
0x16	0.750	0.375	0.250	0.188	0.150
0x17	0.820	0.410	0.273	0.205	0.164
0x18	0.893	0.446	0.298	0.223	0.179
0x19	0.969	0.484	0.323	0.242	0.194
0x1A	1.05	0.524	0.349	0.262	0.210
0x1B	1.13	0.565	0.377	0.282	0.226
0x1C	1.22	0.608	0.405	0.304	0.243

DAC Code	Current (mA) (Full Scale = 25 mA) LEVEL_SET = 000010	Current (mA) (Full Scale = 12.5 mA) LEVEL_SET = 001100	Current (mA) (Full Scale = 8.25 mA) LEVEL_SET = 010110	Current (mA) (Full Scale = 6.25 mA) LEVEL_SET = 100000	Current (mA) (Full Scale = 5.0 mA) LEVEL_SET = 101010
0x1D	1.30	0.652	0.435	0.326	0.261
0x1E	1.40	0.698	0.465	0.349	0.279
0x1F	1.49	0.745	0.497	0.372	0.298
0x20	1.59	0.794	0.529	0.397	0.317
0x21	1.69	0.844	0.563	0.422	0.338
0x22	1.79	0.896	0.597	0.448	0.358
0x23	1.90	0.949	0.633	0.475	0.380
0x24	2.01	1.00	0.670	0.502	0.402
0x25	2.12	1.06	0.707	0.530	0.424
0x26	2.24	1.12	0.746	0.560	0.448
0x27	2.36	1.18	0.786	0.589	0.472
0x28	2.48	1.24	0.827	0.620	0.496
0x29	2.61	1.30	0.869	0.651	0.521
0x2A	2.73	1.37	0.911	0.684	0.547
0x2B	2.87	1.43	0.955	0.716	0.573
0x2C	3.00	1.50	1.00	0.750	0.600
0x2D	3.14	1.57	1.05	0.785	0.628
0x2E	3.28	1.64	1.09	0.820	0.656
0x2F	3.42	1.71	1.14	0.856	0.685
0x30	3.57	1.79	1.19	0.893	0.714
0x31	3.72	1.86	1.24	0.930	0.744
0x32	3.88	1.94	1.29	0.969	0.775
0x33	4.03	2.02	1.34	1.01	0.806
0x34	4.19	2.10	1.40	1.05	0.838
0x35	4.35	2.18	1.45	1.09	0.871
0x36	4.52	2.26	1.51	1.13	0.904
0x37	4.69	2.34	1.56	1.17	0.938
0x38	4.86	2.43	1.62	1.22	0.972
0x39	5.04	2.52	1.68	1.26	1.01
0x3A	5.21	2.61	1.74	1.30	1.04
0x3B	5.40	2.70	1.80	1.35	1.08
0x3C	5.58	2.79	1.86	1.40	1.12
0x3D	5.77	2.88	1.92	1.44	1.15
0x3E	5.96	2.98	1.99	1.49	1.19
0x3F	6.15	3.08	2.05	1.54	1.23
0x40	6.35	3.17	2.12	1.59	1.27
0x41	6.55	3.27	2.18	1.64	1.31
0x42	6.75	3.38	2.25	1.69	1.35
0x43	6.96	3.48	2.32	1.74	1.39
0x44	7.17	3.58	2.39	1.79	1.43
0x45	7.38	3.69	2.46	1.84	1.48
0x46	7.60	3.80	2.53	1.90	1.52
0x47	7.81	3.91	2.60	1.95	1.56
0x48	8.04	4.02	2.68	2.01	1.61
0x49	8.26	4.13	2.75	2.06	1.65
0x4A	8.49	4.24	2.83	2.12	1.70
0x4B	8.72	4.36	2.91	2.18	1.74
0x4C	8.95	4.48	2.98	2.24	1.79
0x4D	9.19	4.59	3.06	2.30	1.84
0x4E	9.43	4.72	3.14	2.36	1.89
0x4F	9.67	4.84	3.22	2.42	1.93

DAC Code	Current (mA) (Full Scale = 25 mA) LEVEL_SET = 000010	Current (mA) (Full Scale = 12.5 mA) LEVEL_SET = 001100	Current (mA) (Full Scale = 8.25 mA) LEVEL_SET = 010110	Current (mA) (Full Scale = 6.25 mA) LEVEL_SET = 100000	Current (mA) (Full Scale = 5.0 mA) LEVEL_SET = 101010
0x50	9.92	4.96	3.31	2.48	1.98
0x51	10.2	5.08	3.39	2.54	2.03
0x52	10.4	5.21	3.47	2.61	2.08
0x53	10.7	5.34	3.56	2.67	2.14
0x54	10.9	5.47	3.65	2.73	2.19
0x55	11.2	5.60	3.73	2.80	2.24
0x56	11.5	5.73	3.82	2.87	2.29
0x57	11.7	5.87	3.91	2.93	2.35
0x58	12.0	6.00	4.00	3.00	2.40
0x59	12.3	6.14	4.09	3.07	2.46
0x5A	12.6	6.28	4.19	3.14	2.51
0x5B	12.8	6.42	4.28	3.21	2.57
0x5C	13.1	6.56	4.37	3.28	2.62
0x5D	13.4	6.70	4.47	3.35	2.68
0x5E	13.7	6.85	4.57	3.42	2.74
0x5F	14.0	6.99	4.66	3.50	2.80
0x60	14.3	7.14	4.76	3.57	2.86
0x61	14.6	7.29	4.86	3.65	2.92
0x62	14.9	7.44	4.96	3.72	2.98
0x63	15.2	7.60	5.06	3.80	3.04
0x64	15.5	7.75	5.17	3.88	3.10
0x65	15.8	7.91	5.27	3.95	3.16
0x66	16.1	8.06	5.38	4.03	3.23
0x67	16.4	8.22	5.48	4.11	3.29
0x68	16.8	8.38	5.59	4.19	3.35
0x69	17.1	8.54	5.70	4.27	3.42
0x6A	17.4	8.71	5.81	4.35	3.48
0x6B	17.7	8.87	5.92	4.44	3.55
0x6C	18.1	9.04	6.03	4.52	3.62
0x6D	18.4	9.21	6.14	4.60	3.68
0x6E	18.8	9.38	6.25	4.69	3.75
0x6F	19.1	9.55	6.37	4.77	3.82
0x70	19.4	9.72	6.48	4.86	3.89
0x71	19.8	9.90	6.60	4.95	3.96
0x72	20.1	10.1	6.71	5.04	4.03
0x73	20.5	10.2	6.83	5.12	4.10
0x74	20.9	10.4	6.95	5.21	4.17
0x75	21.2	10.6	7.07	5.30	4.24
0x76	21.6	10.8	7.19	5.40	4.32
0x77	21.9	11.0	7.32	5.49	4.39
0x78	22.3	11.2	7.44	5.58	4.46
0x79	22.7	11.3	7.56	5.67	4.54
0x7A	23.1	11.5	7.69	5.77	4.61
0x7B	23.4	11.7	7.82	5.86	4.69
0x7C	23.8	11.9	7.94	5.96	4.77
0x7D	24.2	12.1	8.07	6.05	4.84
0x7E	24.6	12.3	8.20	6.15	4.92
0x7F	25.0	12.5	8.33	6.25	5.00

INDEPENDENT SINK REGISTER DESCRIPTIONS***Independent Sink Current Control Register 1 (ISCC1)—Register 0x1A***

Table 40. ISCLAW Bit Map

Bit 7	Bit 6	Bit 5	Bit 4	Bit 3	Bit 2	Bit 1	Bit 0
Reserved					SC9_EN	SC_LAW	

Table 41.

Bit Name	Bit No.	Description
N/A	7:3	Reserved.
SC9_EN	2	This enable acts on LED9. 1 = SC9 is turned on. 0 = SC9 is turned off.
SC_LAW	1:0	SC fade transfer law. 00 = square law DAC, linear time steps. 01 = square law DAC, linear time steps. 10 = square law DAC, nonlinear time steps (Cubic 10). 11 = square law DAC, nonlinear time steps (Cubic 11).

Independent Sink Current Control Register 2 (ISCC2)—Register 0x1B

Table 42. ISCC Bit Map

Bit 7	Bit 6	Bit 5	Bit 4	Bit 3	Bit 2	Bit 1	Bit 0
SC8_EN	SC7_EN	SC6_EN	SC5_EN	SC4_EN	SC3_EN	SC2_EN	SC1_EN

Table 43.

Bit Name	Bit No.	Description
SC8_EN	7	This enable acts on LED8. 1 = SC8 is turned on. 0 = SC8 is turned off.
SC7_EN	6	This enable acts on LED7. 1 = SC7 is turned on. 0 = SC7 is turned off.
SC6_EN	5	This enable acts on LED6. 1 = SC6 is turned on. 0 = SC6 is turned off.
SC5_EN	4	This enable acts on LED5. 1 = SC5 is turned on. 0 = SC5 is turned off.
SC4_EN	3	This enable acts on LED4. 1 = SC4 is turned on. 0 = SC4 is turned off.
SC3_EN	2	This enable acts on LED3. 1 = SC3 is turned on. 0 = SC3 is turned off.
SC2_EN	1	This enable acts on LED2. 1 = SC2 is turned on. 0 = SC2 is turned off.
SC1_EN	0	This enable acts on LED1. 1 = SC1 is turned on. 0 = SC1 is turned off.

Independent Sink Current Time (ISCT1)—Register 0x1C

Table 44. ISCT1 Bit Map

Bit 7	Bit 6	Bit 5	Bit 4	Bit 3	Bit 2	Bit 1	Bit 0
SCON				Reserved		SC5OFF	

Table 45.

Bit Name	Bit No.	Description
SCON	[7:4]	SC on time. If the SCxOFF time is not disabled, then when the independent current sink is enabled (Register 0x1A and Register 0x1B), it remains on for the on time selected (per the following list) and then turns off. 0000 = 0.00 sec ¹ . 0001 = 0.05 sec. 0010 = 0.10 sec. 0011 = 0.15 sec. 0100 = 0.20 sec. 0101 = 0.25 sec. 0110 = 0.30 sec. 0111 = 0.35 sec. 1000 = 0.40 sec. 1001 = 0.45 sec. 1010 = 0.50 sec. 1011 = 0.55 sec. 1100 = 0.60 sec. 1101 = 0.65 sec. 1110 = 0.70 sec. 1111 = 0.75 sec.
N/A	[3:2]	Reserved.
SC5OFF	[1:0]	SC5 off time. When the SC off time is disabled, the SC remains on while enabled. When the SC off time is set to any other value, the ISC turns off for the off time (per the following listed times) and then turns on according to the SCON setting. 00 = off time disabled ² . 01 = 0.6 sec. 10 = 1.2 sec. 11 = 1.8 sec.

¹ If SCON is set to 0 sec, then after the ISC completes a ramp up, it immediately starts to ramp back down again (if SCxOFF is not disabled). SCON should not be set to 0 if the fade-in time is also 0 seconds.

² An independent sink remains on continuously when it is enabled and SCxOFF is disabled.

Independent Sink Current Time (ISCT2)—Register 0x1D

Table 46. ISCT2 Bit Map

Bit 7	Bit 6	Bit 5	Bit 4	Bit 3	Bit 2	Bit 1	Bit 0
SC4OFF		SC3OFF		SC2OFF		SC1OFF	

Table 47.

Designation	Bit	Description ¹
SC4OFF	[7:6]	SC4 off time. When the SC off time is disabled, the SC remains on while enabled. When the SC off time is set to any other value, the ISC turns off for the off time (per the following listed times) and then turns on according to the SCON setting. 00 = off time disabled. 01 = 0.6 sec. 10 = 1.2 sec. 11 = 1.8 sec.
SC3OFF	[5:4]	SC3 off time. When the SC off time is disabled, the SC remains on while enabled. When the SC off time is set to any other value, the ISC turns off for the off time (per the following listed times) and then turns on according to the SCON setting. 00 = off time disabled. 01 = 0.6 sec. 10 = 1.2 sec. 11 = 1.8 sec.
SC2OFF	[3:2]	SC2 off time. When the SC off time is disabled, the SC remains on while enabled. When the SC off time is set to any other value, the ISC turns off for the off time (per the following listed times) and then turns on according to the SCON setting. 00 = off time disabled. 01 = 0.6 sec. 10 = 1.2 sec. 11 = 1.8 sec.
SC1OFF	[1:0]	SC1 off time. When the SC off time is disabled, the SC remains on while enabled. When the SC off time is set to any other value, the ISC turns off for the off time (per the following listed times) and then turns on according to the SCON setting. 00 = off time disabled. 01 = 0.6 sec. 10 = 1.2 sec. 11 = 1.8 sec.

¹ An independent sink remains on continuously when it is enabled and SCxOFF is 00 (disabled).

Independent Sink 6 Off Timer (OFFTIMER6)—Register 0x1E

Table 48. OFFTIMER6 Bit Map

Bit 7	Bit 6	Bit 5	Bit 4	Bit 3	Bit 2	Bit 1	Bit 0
Reserved	SC6OFF						

Table 49.

Bit Name	Bit No.	Description
N/A	7	Reserved.
SC6OFF	[6:0]	SC6 off time. When the SC off time is disabled, the SC remains on while enabled. When the SC off time is set to any other value, the ISC turns off for the off time (per the following listed times) and then turns on according to the SCON setting. 0000 = disabled ¹ . 0000001 = 0.0 sec ² . 0000010 = 0.1 sec. 0000011 = 0.2 sec. ... 1111110 = 12.5 sec. 1111111 = off ³ .

¹ An independent sink remains on continuously when it is enabled and SCxOFF is 00 (disabled).

² Setting SCxOFF to 0 seconds is not recommended if the SCFO fade-out time is also set to 0 seconds.

³ Setting SCxOFF to off causes the LED to be held off indefinitely. This is useful for setting up a blink sequence that runs once and then goes to off.

Independent Sink 7 Off Timer (OFFTIMER7)—Register 0x1F**Table 50. OFFTIMER7 Bit Map**

Bit 7	Bit 6	Bit 5	Bit 4	Bit 3	Bit 2	Bit 1	Bit 0
Reserved	SC7OFF						

Table 51.

Bit Name	Bit No.	Description
N/A	7	Reserved.
SC7OFF	[6:0]	<p>SC7 off time. When the SC off time is disabled, the SC remains on while enabled. When the SC off time is set to any other value, the ISC turns off for the off time (per the following listed times) and then turns on according to the SCON setting.</p> <p>0000 = disabled¹. 0000001 = 0.0 sec². 0000010 = 0.1 sec. 0000011 = 0.2 sec. ... 1111110 = 12.5 sec. 1111111 = off³.</p>

¹ An independent sink remains on continuously when it is enabled and SCxOFF is 00 (disabled).² Setting SCxOFF to 0 seconds is not recommended if the SCFO fade-out time is also set to 0 seconds.³ Setting SCxOFF to off causes the LED to be held off indefinitely. This is useful for setting up a blink sequence that runs once and then goes to off.**Independent Sink 8 Off Timer (OFFTIMER8)—Register 0x20****Table 52. OFFTIMER8 Bit Map**

Bit 7	Bit 6	Bit 5	Bit 4	Bit 3	Bit 2	Bit 1	Bit 0
Reserved	SC8OFF						

Table 53.

Bit Name	Bit No.	Description
N/A	7	Reserved
SC8OFF	[6:0]	<p>SC8 off time. When the SC off time is disabled, the SC remains on while enabled. When the SC off time is set to any other value, the ISC turns off for the off time (per the following listed times) and then turns on according to the SCON setting.</p> <p>0000 = disabled¹. 0000001 = 0.0 sec². 0000010 = 0.1 sec. 0000011 = 0.2 sec. ... 1111110 = 12.5 sec. 1111111 = off³.</p>

¹ An independent sink remains on continuously when it is enabled and SCxOFF is 00 (disabled).² Setting SCxOFF to 0 seconds is not recommended if the SCFO fade-out time is also set to 0 seconds.³ Setting SCxOFF to off causes the LED to be held off indefinitely. This is useful for setting up a blink sequence that runs once and then goes to off.

Independent Sink 9 Off Timer (OFFTIMER9)—Register 0x21

Table 54. OFFTIMER9 Bit Map

Bit 7	Bit 6	Bit 5	Bit 4	Bit 3	Bit 2	Bit 1	Bit 0
Reserved	SC9OFF						

Table 55.

Bit Name	Bit No.	Description
N/A	7	Reserved.
SC9OFF	[6:0]	<p>SC9 off time. When the SC off time is disabled, the SC remains on while enabled. When the SC off time is set to any other value, the ISC turns off for the off time (per the following listed times) and then turns on according to the SCON setting.</p> <p>0000 = disabled¹. 0000001 = 0.0 sec². 0000010 = 0.1 sec. 0000011 = 0.2 sec. ... 1111110 = 12.5 sec. 1111111 = off³.</p>

¹ An independent sink remains on continuously when it is enabled and SCxOFF is 00 (disabled).² Setting SCxOFF to 0 seconds is not recommended if the SCFO fade-out time is also set to 0 seconds.³ Setting SCxOFF to off causes the LED to be held off indefinitely. This is useful for setting up a blink sequence that runs once and then goes to off.**Independent Sink Current Fade (ISCF)—Register 0x22**

Table 56. ISCF Bit Map

Bit 7	Bit 6	Bit 5	Bit 4	Bit 3	Bit 2	Bit 1	Bit 0
SCFO				SCFI			

Table 57.

Bit Name	Bit No.	Description
SCFO	[7:4]	<p>Sink current fade-out time. Note that the fade time given is from full scale to zero (the actual full-scale value is affected by the LEVEL_SET bits). Binary code fade-out times are as follows:</p> <p>0000 = disabled. 0001 = 0.05 sec. 0010 = 0.10 sec. 0011 = 0.15 sec. 0100 = 0.20 sec. 0101 = 0.25 sec. 0110 = 0.30 sec. 0111 = 0.35 sec. 1000 = 0.40 sec. 1001 = 0.45 sec. 1010 = 0.50 sec. 1011 = 0.75 sec. 1100 = 1.00 sec. 1101 = 1.25 sec. 1110 = 1.50 sec. 1111 = 1.75 sec.</p>

Bit Name	Bit No.	Description
SCFI	[3:0]	Sink current fade-in time. Note that the fade time given is from zero to full scale (the actual full-scale value is affected by the LEVEL_SET bits). Binary code fade-out times are as follows: 0000 = disabled. 0001 = 0.05 sec. 0010 = 0.10 sec. 0011 = 0.15 sec. 0100 = 0.20 sec. ... 1111 = 1.75 sec.

Sink Current Register LED1(ISC1)—Register 0x23

Table 58. ISC1 Bit Map

Bit 7	Bit 6	Bit 5	Bit 4	Bit 3	Bit 2	Bit 1	Bit 0
Reserved	SCD1						

Table 59.

Bit Name	Bit No.	Description																																										
N/A	7	Reserved.																																										
SCD1	[6:0]	Sink current. All values scale with the setting of LEVEL_SET. See Table 39 for a complete list of values.																																										
		<table border="1"> <thead> <tr> <th>DAC Code</th> <th>Current (mA) (Full Scale = 25 mA) LEVEL_SET = 000010</th> <th>Current (mA) (Full Scale = 12.5 mA) LEVEL_SET = 001100</th> <th>Current (mA) (Full Scale = 8.25 mA) LEVEL_SET = 010110</th> <th>Current (mA) (Full Scale = 6.25 mA) LEVEL_SET = 100000</th> <th>Current (mA) (Full Scale = 5.0 mA) LEVEL_SET = 101010</th> </tr> </thead> <tbody> <tr> <td>0x00</td> <td>0.0</td> <td>0.0</td> <td>0.0</td> <td>0.0</td> <td>0.0</td> </tr> <tr> <td>0x01</td> <td>0.0016</td> <td>0.0008</td> <td>0.0005</td> <td>0.0004</td> <td>0.0003</td> </tr> <tr> <td>0x02</td> <td>0.0062</td> <td>0.0031</td> <td>0.0021</td> <td>0.0016</td> <td>0.0012</td> </tr> <tr> <td>0x03</td> <td>0.014</td> <td>0.0070</td> <td>0.0047</td> <td>0.0035</td> <td>0.0028</td> </tr> <tr> <td>...</td> <td>...</td> <td>...</td> <td>...</td> <td>...</td> <td>...</td> </tr> <tr> <td>0x7F</td> <td>25.0</td> <td>12.5</td> <td>8.33</td> <td>6.25</td> <td>5.0</td> </tr> </tbody> </table>	DAC Code	Current (mA) (Full Scale = 25 mA) LEVEL_SET = 000010	Current (mA) (Full Scale = 12.5 mA) LEVEL_SET = 001100	Current (mA) (Full Scale = 8.25 mA) LEVEL_SET = 010110	Current (mA) (Full Scale = 6.25 mA) LEVEL_SET = 100000	Current (mA) (Full Scale = 5.0 mA) LEVEL_SET = 101010	0x00	0.0	0.0	0.0	0.0	0.0	0x01	0.0016	0.0008	0.0005	0.0004	0.0003	0x02	0.0062	0.0031	0.0021	0.0016	0.0012	0x03	0.014	0.0070	0.0047	0.0035	0.0028	0x7F	25.0	12.5	8.33	6.25	5.0
DAC Code	Current (mA) (Full Scale = 25 mA) LEVEL_SET = 000010	Current (mA) (Full Scale = 12.5 mA) LEVEL_SET = 001100	Current (mA) (Full Scale = 8.25 mA) LEVEL_SET = 010110	Current (mA) (Full Scale = 6.25 mA) LEVEL_SET = 100000	Current (mA) (Full Scale = 5.0 mA) LEVEL_SET = 101010																																							
0x00	0.0	0.0	0.0	0.0	0.0																																							
0x01	0.0016	0.0008	0.0005	0.0004	0.0003																																							
0x02	0.0062	0.0031	0.0021	0.0016	0.0012																																							
0x03	0.014	0.0070	0.0047	0.0035	0.0028																																							
...																																							
0x7F	25.0	12.5	8.33	6.25	5.0																																							

Sink Current Register LED2 (ISC2)—Register 0x24

Table 60. ISC2 Bit Map

Bit 7	Bit 6	Bit 5	Bit 4	Bit 3	Bit 2	Bit 1	Bit 0
Reserved	SCD2						

Table 61.

Bit Name	Bit No.	Description																																										
N/A	7	Reserved.																																										
SCD2	[6:0]	Sink current. All values scale with the setting of LEVEL_SET. See Table 39 for a complete list of values.																																										
		<table border="1"> <thead> <tr> <th>DAC Code</th> <th>Current (mA) (Full Scale = 25 mA) LEVEL_SET = 000010</th> <th>Current (mA) (Full Scale = 12.5 mA) LEVEL_SET=001100</th> <th>Current (mA) (Full Scale = 8.25 mA) LEVEL_SET=010110</th> <th>Current (mA) (Full Scale = 6.25 mA) LEVEL_SET=100000</th> <th>Current (mA) (Full Scale = 5.0 mA) LEVEL_SET = 101010</th> </tr> </thead> <tbody> <tr> <td>0x00</td> <td>0.0</td> <td>0.0</td> <td>0.0</td> <td>0.0</td> <td>0.0</td> </tr> <tr> <td>0x01</td> <td>0.0016</td> <td>0.0008</td> <td>0.0005</td> <td>0.0004</td> <td>0.0003</td> </tr> <tr> <td>0x02</td> <td>0.0062</td> <td>0.0031</td> <td>0.0021</td> <td>0.0016</td> <td>0.0012</td> </tr> <tr> <td>0x03</td> <td>0.014</td> <td>0.0070</td> <td>0.0047</td> <td>0.0035</td> <td>0.0028</td> </tr> <tr> <td>...</td> <td>...</td> <td>...</td> <td>...</td> <td>...</td> <td>...</td> </tr> <tr> <td>0x7F</td> <td>25.0</td> <td>12.5</td> <td>8.33</td> <td>6.25</td> <td>5.0</td> </tr> </tbody> </table>	DAC Code	Current (mA) (Full Scale = 25 mA) LEVEL_SET = 000010	Current (mA) (Full Scale = 12.5 mA) LEVEL_SET=001100	Current (mA) (Full Scale = 8.25 mA) LEVEL_SET=010110	Current (mA) (Full Scale = 6.25 mA) LEVEL_SET=100000	Current (mA) (Full Scale = 5.0 mA) LEVEL_SET = 101010	0x00	0.0	0.0	0.0	0.0	0.0	0x01	0.0016	0.0008	0.0005	0.0004	0.0003	0x02	0.0062	0.0031	0.0021	0.0016	0.0012	0x03	0.014	0.0070	0.0047	0.0035	0.0028	0x7F	25.0	12.5	8.33	6.25	5.0
DAC Code	Current (mA) (Full Scale = 25 mA) LEVEL_SET = 000010	Current (mA) (Full Scale = 12.5 mA) LEVEL_SET=001100	Current (mA) (Full Scale = 8.25 mA) LEVEL_SET=010110	Current (mA) (Full Scale = 6.25 mA) LEVEL_SET=100000	Current (mA) (Full Scale = 5.0 mA) LEVEL_SET = 101010																																							
0x00	0.0	0.0	0.0	0.0	0.0																																							
0x01	0.0016	0.0008	0.0005	0.0004	0.0003																																							
0x02	0.0062	0.0031	0.0021	0.0016	0.0012																																							
0x03	0.014	0.0070	0.0047	0.0035	0.0028																																							
...																																							
0x7F	25.0	12.5	8.33	6.25	5.0																																							

Sink Current Register LED3 (ISC3)—Register 0x25

Table 62. ISC3 Bit Map

Bit 7	Bit 6	Bit 5	Bit 4	Bit 3	Bit 2	Bit 1	Bit 0
Reserved	SCD3						

Table 63.

Bit Name	Bit No.	Description					
N/A	7	Reserved.					
SCD3	[6:0]	Sink current. All values scale with the setting of LEVEL_SET. See Table 39 for a complete list of values.					
		DAC Code	Current (mA) (Full Scale = 25 mA) LEVEL_SET = 000010	Current (mA) (Full Scale = 12.5 mA) LEVEL_SET = 001100	Current (mA) (Full Scale = 8.25 mA) LEVEL_SET = 010110	Current (mA) (Full Scale = 6.25 mA) LEVEL_SET = 100000	Current (mA) (Full Scale = 5.0 mA) LEVEL_SET = 101010
		0x00	0.0	0.0	0.0	0.0	0.0
		0x01	0.0016	0.0008	0.0005	0.0004	0.0003
		0x02	0.0062	0.0031	0.0021	0.0016	0.0012
		0x03	0.014	0.0070	0.0047	0.0035	0.0028
	
0x7F	25.0	12.5	8.33	6.25	5.0		

Sink Current Register LED4 (ISC4)—Register 0x26

Table 64. ISC4 Bit Map

Bit 7	Bit 6	Bit 5	Bit 4	Bit 3	Bit 2	Bit 1	Bit 0
Reserved	SCD4						

Table 65.

Bit Name	Bit No.	Description					
N/A	7	Reserved.					
SCD4	[6:0]	Sink current. All values scale with the setting of LEVEL_SET. See Table 39 for a complete list of values.					
		DAC Code	Current (mA) (Full Scale = 25 mA) LEVEL_SET = 000010	Current (mA) (Full Scale = 12.5 mA) LEVEL_SET = 001100	Current (mA) (Full Scale = 8.25 mA) LEVEL_SET = 010110	Current (mA) (Full Scale = 6.25 mA) LEVEL_SET = 100000	Current (mA) (Full Scale = 5.0 mA) LEVEL_SET = 101010
		0x00	0.0	0.0	0.0	0.0	0.0
		0x01	0.0016	0.0008	0.0005	0.0004	0.0003
		0x02	0.0062	0.0031	0.0021	0.0016	0.0012
		0x03	0.014	0.0070	0.0047	0.0035	0.0028
	
0x7F	25.0	12.5	8.33	6.25	5.0		

Sink Current Register LED5 (ISC5)—Register 0x27

Table 66. ISC5 Bit Map

Bit 7	Bit 6	Bit 5	Bit 4	Bit 3	Bit 2	Bit 1	Bit 0
Reserved	SCD5						

Table 67.

Bit Name	Bit No.	Description																																										
N/A	7	Reserved.																																										
SCD5	[6:0]	Sink current. All values scale with the setting of LEVEL_SET. See Table 39 for a complete list of values.																																										
		<table border="1"> <thead> <tr> <th>DAC Code</th> <th>Current (mA) (Full Scale = 25 mA) LEVEL_SET = 000010</th> <th>Current (mA) (Full Scale = 12.5 mA) LEVEL_SET = 001100</th> <th>Current (mA) (Full Scale = 8.25 mA) LEVEL_SET = 010110</th> <th>Current (mA) (Full Scale = 6.25 mA) LEVEL_SET = 100000</th> <th>Current (mA) (Full Scale = 5.0 mA) LEVEL_SET = 101010</th> </tr> </thead> <tbody> <tr> <td>0x00</td> <td>0.0</td> <td>0.0</td> <td>0.0</td> <td>0.0</td> <td>0.0</td> </tr> <tr> <td>0x01</td> <td>0.0016</td> <td>0.0008</td> <td>0.0005</td> <td>0.0004</td> <td>0.0003</td> </tr> <tr> <td>0x02</td> <td>0.0062</td> <td>0.0031</td> <td>0.0021</td> <td>0.0016</td> <td>0.0012</td> </tr> <tr> <td>0x03</td> <td>0.014</td> <td>0.0070</td> <td>0.0047</td> <td>0.0035</td> <td>0.0028</td> </tr> <tr> <td>...</td> <td>...</td> <td>...</td> <td>...</td> <td>...</td> <td>...</td> </tr> <tr> <td>0x7F</td> <td>25.0</td> <td>12.5</td> <td>8.33</td> <td>6.25</td> <td>5.0</td> </tr> </tbody> </table>	DAC Code	Current (mA) (Full Scale = 25 mA) LEVEL_SET = 000010	Current (mA) (Full Scale = 12.5 mA) LEVEL_SET = 001100	Current (mA) (Full Scale = 8.25 mA) LEVEL_SET = 010110	Current (mA) (Full Scale = 6.25 mA) LEVEL_SET = 100000	Current (mA) (Full Scale = 5.0 mA) LEVEL_SET = 101010	0x00	0.0	0.0	0.0	0.0	0.0	0x01	0.0016	0.0008	0.0005	0.0004	0.0003	0x02	0.0062	0.0031	0.0021	0.0016	0.0012	0x03	0.014	0.0070	0.0047	0.0035	0.0028	0x7F	25.0	12.5	8.33	6.25	5.0
		DAC Code	Current (mA) (Full Scale = 25 mA) LEVEL_SET = 000010	Current (mA) (Full Scale = 12.5 mA) LEVEL_SET = 001100	Current (mA) (Full Scale = 8.25 mA) LEVEL_SET = 010110	Current (mA) (Full Scale = 6.25 mA) LEVEL_SET = 100000	Current (mA) (Full Scale = 5.0 mA) LEVEL_SET = 101010																																					
		0x00	0.0	0.0	0.0	0.0	0.0																																					
		0x01	0.0016	0.0008	0.0005	0.0004	0.0003																																					
		0x02	0.0062	0.0031	0.0021	0.0016	0.0012																																					
		0x03	0.014	0.0070	0.0047	0.0035	0.0028																																					
...																																							
0x7F	25.0	12.5	8.33	6.25	5.0																																							

Sink Current Register LED6 (ISC6)—Register 0x28

Table 68. ISC6 Bit Map

Bit 7	Bit 6	Bit 5	Bit 4	Bit 3	Bit 2	Bit 1	Bit 0
Reserved	SCD6						

Table 69.

Bit Name	Bit No.	Description																																										
N/A	7	Reserved.																																										
SCD6	[6:0]	Sink current. All values scale with the setting of LEVEL_SET. See Table 39 for a complete list of values.																																										
		<table border="1"> <thead> <tr> <th>DAC Code</th> <th>Current (mA) (Full Scale = 25 mA) LEVEL_SET = 000010</th> <th>Current (mA) (Full Scale = 12.5 mA) LEVEL_SET = 001100</th> <th>Current (mA) (Full Scale = 8.25 mA) LEVEL_SET = 010110</th> <th>Current (mA) (Full Scale = 6.25 mA) LEVEL_SET = 100000</th> <th>Current (mA) (Full Scale = 5.0 mA) LEVEL_SET = 101010</th> </tr> </thead> <tbody> <tr> <td>0x00</td> <td>0.0</td> <td>0.0</td> <td>0.0</td> <td>0.0</td> <td>0.0</td> </tr> <tr> <td>0x01</td> <td>0.0016</td> <td>0.0008</td> <td>0.0005</td> <td>0.0004</td> <td>0.0003</td> </tr> <tr> <td>0x02</td> <td>0.0062</td> <td>0.0031</td> <td>0.0021</td> <td>0.0016</td> <td>0.0012</td> </tr> <tr> <td>0x03</td> <td>0.014</td> <td>0.0070</td> <td>0.0047</td> <td>0.0035</td> <td>0.0028</td> </tr> <tr> <td>...</td> <td>...</td> <td>...</td> <td>...</td> <td>...</td> <td>...</td> </tr> <tr> <td>0x7F</td> <td>25.0</td> <td>12.5</td> <td>8.33</td> <td>6.25</td> <td>5.0</td> </tr> </tbody> </table>	DAC Code	Current (mA) (Full Scale = 25 mA) LEVEL_SET = 000010	Current (mA) (Full Scale = 12.5 mA) LEVEL_SET = 001100	Current (mA) (Full Scale = 8.25 mA) LEVEL_SET = 010110	Current (mA) (Full Scale = 6.25 mA) LEVEL_SET = 100000	Current (mA) (Full Scale = 5.0 mA) LEVEL_SET = 101010	0x00	0.0	0.0	0.0	0.0	0.0	0x01	0.0016	0.0008	0.0005	0.0004	0.0003	0x02	0.0062	0.0031	0.0021	0.0016	0.0012	0x03	0.014	0.0070	0.0047	0.0035	0.0028	0x7F	25.0	12.5	8.33	6.25	5.0
		DAC Code	Current (mA) (Full Scale = 25 mA) LEVEL_SET = 000010	Current (mA) (Full Scale = 12.5 mA) LEVEL_SET = 001100	Current (mA) (Full Scale = 8.25 mA) LEVEL_SET = 010110	Current (mA) (Full Scale = 6.25 mA) LEVEL_SET = 100000	Current (mA) (Full Scale = 5.0 mA) LEVEL_SET = 101010																																					
		0x00	0.0	0.0	0.0	0.0	0.0																																					
		0x01	0.0016	0.0008	0.0005	0.0004	0.0003																																					
		0x02	0.0062	0.0031	0.0021	0.0016	0.0012																																					
		0x03	0.014	0.0070	0.0047	0.0035	0.0028																																					
...																																							
0x7F	25.0	12.5	8.33	6.25	5.0																																							

Sink Current Register LED7 (ISC7)—Register 0x29

Table 70. ISC7 Bit Map

Bit 7	Bit 6	Bit 5	Bit 4	Bit 3	Bit 2	Bit 1	Bit 0
Reserved	SCD7						

Table 71.

Bit Name	Bit No.	Description																																										
N/A	7	Reserved.																																										
SCD7	[6:0]	Sink current. All values scale with the setting of LEVEL_SET. See Table 39 for a complete list of values.																																										
		<table border="1"> <thead> <tr> <th>DAC Code</th> <th>Current (mA) (Full Scale = 25 mA) LEVEL_SET = 000010</th> <th>Current (mA) (Full Scale = 12.5 mA) LEVEL_SET = 001100</th> <th>Current (mA) (Full Scale = 8.25 mA) LEVEL_SET = 010110</th> <th>Current (mA) (Full Scale = 6.25 mA) LEVEL_SET = 100000</th> <th>Current (mA) (Full Scale = 5.0 mA) LEVEL_SET = 101010</th> </tr> </thead> <tbody> <tr> <td>0x00</td> <td>0.0</td> <td>0.0</td> <td>0.0</td> <td>0.0</td> <td>0.0</td> </tr> <tr> <td>0x01</td> <td>0.0016</td> <td>0.0008</td> <td>0.0005</td> <td>0.0004</td> <td>0.0003</td> </tr> <tr> <td>0x02</td> <td>0.0062</td> <td>0.0031</td> <td>0.0021</td> <td>0.0016</td> <td>0.0012</td> </tr> <tr> <td>0x03</td> <td>0.014</td> <td>0.0070</td> <td>0.0047</td> <td>0.0035</td> <td>0.0028</td> </tr> <tr> <td>...</td> <td>...</td> <td>...</td> <td>...</td> <td>...</td> <td>...</td> </tr> <tr> <td>0x7F</td> <td>25.0</td> <td>12.5</td> <td>8.33</td> <td>6.25</td> <td>5.0</td> </tr> </tbody> </table>	DAC Code	Current (mA) (Full Scale = 25 mA) LEVEL_SET = 000010	Current (mA) (Full Scale = 12.5 mA) LEVEL_SET = 001100	Current (mA) (Full Scale = 8.25 mA) LEVEL_SET = 010110	Current (mA) (Full Scale = 6.25 mA) LEVEL_SET = 100000	Current (mA) (Full Scale = 5.0 mA) LEVEL_SET = 101010	0x00	0.0	0.0	0.0	0.0	0.0	0x01	0.0016	0.0008	0.0005	0.0004	0.0003	0x02	0.0062	0.0031	0.0021	0.0016	0.0012	0x03	0.014	0.0070	0.0047	0.0035	0.0028	0x7F	25.0	12.5	8.33	6.25	5.0
		DAC Code	Current (mA) (Full Scale = 25 mA) LEVEL_SET = 000010	Current (mA) (Full Scale = 12.5 mA) LEVEL_SET = 001100	Current (mA) (Full Scale = 8.25 mA) LEVEL_SET = 010110	Current (mA) (Full Scale = 6.25 mA) LEVEL_SET = 100000	Current (mA) (Full Scale = 5.0 mA) LEVEL_SET = 101010																																					
		0x00	0.0	0.0	0.0	0.0	0.0																																					
		0x01	0.0016	0.0008	0.0005	0.0004	0.0003																																					
		0x02	0.0062	0.0031	0.0021	0.0016	0.0012																																					
		0x03	0.014	0.0070	0.0047	0.0035	0.0028																																					
...																																							
0x7F	25.0	12.5	8.33	6.25	5.0																																							

Sink Current Register LED8 (ISC8)—Register 0x2A

Table 72. ISC8 Bit Map

Bit 7	Bit 6	Bit 5	Bit 4	Bit 3	Bit 2	Bit 1	Bit 0
Reserved	SCD8						

Table 73.

Bit Name	Bit No.	Description																																										
N/A	7	Reserved.																																										
SCD8	[6:0]	Sink current. All values scale with the setting of LEVEL_SET. See Table 39 for a complete list of values.																																										
		<table border="1"> <thead> <tr> <th>DAC Code</th> <th>Current (mA) (Full Scale = 25 mA) LEVEL_SET = 000010</th> <th>Current (mA) (Full Scale = 12.5 mA) LEVEL_SET = 001100</th> <th>Current (mA) (Full Scale = 8.25 mA) LEVEL_SET = 010110</th> <th>Current (mA) (Full Scale = 6.25 mA) LEVEL_SET = 100000</th> <th>Current (mA) (Full Scale = 5.0 mA) LEVEL_SET = 101010</th> </tr> </thead> <tbody> <tr> <td>0x00</td> <td>0.0</td> <td>0.0</td> <td>0.0</td> <td>0.0</td> <td>0.0</td> </tr> <tr> <td>0x01</td> <td>0.0016</td> <td>0.0008</td> <td>0.0005</td> <td>0.0004</td> <td>0.0003</td> </tr> <tr> <td>0x02</td> <td>0.0062</td> <td>0.0031</td> <td>0.0021</td> <td>0.0016</td> <td>0.0012</td> </tr> <tr> <td>0x03</td> <td>0.014</td> <td>0.0070</td> <td>0.0047</td> <td>0.0035</td> <td>0.0028</td> </tr> <tr> <td>...</td> <td>...</td> <td>...</td> <td>...</td> <td>...</td> <td>...</td> </tr> <tr> <td>0x7F</td> <td>25.0</td> <td>12.5</td> <td>8.33</td> <td>6.25</td> <td>5.0</td> </tr> </tbody> </table>	DAC Code	Current (mA) (Full Scale = 25 mA) LEVEL_SET = 000010	Current (mA) (Full Scale = 12.5 mA) LEVEL_SET = 001100	Current (mA) (Full Scale = 8.25 mA) LEVEL_SET = 010110	Current (mA) (Full Scale = 6.25 mA) LEVEL_SET = 100000	Current (mA) (Full Scale = 5.0 mA) LEVEL_SET = 101010	0x00	0.0	0.0	0.0	0.0	0.0	0x01	0.0016	0.0008	0.0005	0.0004	0.0003	0x02	0.0062	0.0031	0.0021	0.0016	0.0012	0x03	0.014	0.0070	0.0047	0.0035	0.0028	0x7F	25.0	12.5	8.33	6.25	5.0
		DAC Code	Current (mA) (Full Scale = 25 mA) LEVEL_SET = 000010	Current (mA) (Full Scale = 12.5 mA) LEVEL_SET = 001100	Current (mA) (Full Scale = 8.25 mA) LEVEL_SET = 010110	Current (mA) (Full Scale = 6.25 mA) LEVEL_SET = 100000	Current (mA) (Full Scale = 5.0 mA) LEVEL_SET = 101010																																					
		0x00	0.0	0.0	0.0	0.0	0.0																																					
		0x01	0.0016	0.0008	0.0005	0.0004	0.0003																																					
		0x02	0.0062	0.0031	0.0021	0.0016	0.0012																																					
		0x03	0.014	0.0070	0.0047	0.0035	0.0028																																					
...																																							
0x7F	25.0	12.5	8.33	6.25	5.0																																							

Sink Current Register LED9 (ISC9)—Register 0x2B

Table 74. ISC9 Bit Map

Bit 7	Bit 6	Bit 5	Bit 4	Bit 3	Bit 2	Bit 1	Bit 0
Reserved	SCD9						

Table 75.

Bit Name	Bit No.	Description																																										
N/A	7	Reserved.																																										
SCD9	[6:0]	Sink current. All values scale with the setting of LEVEL_SET. See Table 39 for a complete list of values.																																										
		<table border="1"> <thead> <tr> <th>DAC Code</th> <th>Current (mA) (Full Scale = 25 mA) LEVEL_SET = 000010</th> <th>Current (mA) (Full Scale = 12.5 mA) LEVEL_SET = 001100</th> <th>Current (mA) (Full Scale = 8.25 mA) LEVEL_SET = 010110</th> <th>Current (mA) (Full Scale = 6.25 mA) LEVEL_SET = 100000</th> <th>Current (mA) (Full Scale = 5.0 mA) LEVEL_SET = 101010</th> </tr> </thead> <tbody> <tr> <td>0x00</td> <td>0.0</td> <td>0.0</td> <td>0.0</td> <td>0.0</td> <td>0.0</td> </tr> <tr> <td>0x01</td> <td>0.0016</td> <td>0.0008</td> <td>0.0005</td> <td>0.0004</td> <td>0.0003</td> </tr> <tr> <td>0x02</td> <td>0.0062</td> <td>0.0031</td> <td>0.0021</td> <td>0.0016</td> <td>0.0012</td> </tr> <tr> <td>0x03</td> <td>0.014</td> <td>0.0070</td> <td>0.0047</td> <td>0.0035</td> <td>0.0028</td> </tr> <tr> <td>...</td> <td>...</td> <td>...</td> <td>...</td> <td>...</td> <td>...</td> </tr> <tr> <td>0x7F</td> <td>25.0</td> <td>12.5</td> <td>8.33</td> <td>6.25</td> <td>5.0</td> </tr> </tbody> </table>	DAC Code	Current (mA) (Full Scale = 25 mA) LEVEL_SET = 000010	Current (mA) (Full Scale = 12.5 mA) LEVEL_SET = 001100	Current (mA) (Full Scale = 8.25 mA) LEVEL_SET = 010110	Current (mA) (Full Scale = 6.25 mA) LEVEL_SET = 100000	Current (mA) (Full Scale = 5.0 mA) LEVEL_SET = 101010	0x00	0.0	0.0	0.0	0.0	0.0	0x01	0.0016	0.0008	0.0005	0.0004	0.0003	0x02	0.0062	0.0031	0.0021	0.0016	0.0012	0x03	0.014	0.0070	0.0047	0.0035	0.0028	0x7F	25.0	12.5	8.33	6.25	5.0
		DAC Code	Current (mA) (Full Scale = 25 mA) LEVEL_SET = 000010	Current (mA) (Full Scale = 12.5 mA) LEVEL_SET = 001100	Current (mA) (Full Scale = 8.25 mA) LEVEL_SET = 010110	Current (mA) (Full Scale = 6.25 mA) LEVEL_SET = 100000	Current (mA) (Full Scale = 5.0 mA) LEVEL_SET = 101010																																					
		0x00	0.0	0.0	0.0	0.0	0.0																																					
		0x01	0.0016	0.0008	0.0005	0.0004	0.0003																																					
		0x02	0.0062	0.0031	0.0021	0.0016	0.0012																																					
		0x03	0.014	0.0070	0.0047	0.0035	0.0028																																					
...																																							
0x7F	25.0	12.5	8.33	6.25	5.0																																							

Heartbeat Enable Selection (HB_SEL)—Register 0x2C

Table 76. HB_SEL Bit Map

Bit 7	Bit 6	Bit 5	Bit 4	Bit 3	Bit 2	Bit 1	Bit 0
Reserved				D9HB_EN	D8HB_EN	D7HB_EN	D6HB_EN

Table 77.

Bit Name	Bit No.	Description
N/A	[7:4]	Reserved.
D9HB_EN	3	Diode 9 heartbeat enable. 1 = heartbeat for this channel is enabled (all HB registers apply to every even numbered pulse). 0 = heartbeat for this channel is disabled (all HB registers are ignored).
D8HB_EN	2	Diode 8 heartbeat enable. 1 = heartbeat for this channel is enabled (all HB registers apply to every even numbered pulse). 0 = heartbeat for this channel is disabled (all HB registers are ignored).
D7HB_EN	1	Diode 7 heartbeat enable. 1 = heartbeat for this channel is enabled (all HB registers apply to every even numbered pulse). 0 = heartbeat for this channel is disabled (all HB registers are ignored).
D6HB_EN	0	Diode 6 heartbeat enable. 1 = heartbeat for this channel is enabled (all HB registers apply to every even numbered pulse). 0 = heartbeat for this channel is disabled (all HB registers are ignored).

Independent Sink Current LED6—Even Heartbeat Pulses (ISC6_HB)—Register 0x2D

Table 78. ISC6_HB Bit Map

Bit 7	Bit 6	Bit 5	Bit 4	Bit 3	Bit 2	Bit 1	Bit 0
Reserved	SCD6_HB						

Table 79.

Bit Name	Bit No.	Description																																										
N/A	7	Reserved.																																										
SCD6_HB	[6:0]	Sink current for the even numbered pulses when heartbeat mode for this channel is enabled. Use the following DAC code schedule. See Table 39 for a complete list of values.																																										
		<table border="1"> <thead> <tr> <th>DAC Code</th> <th>Current (mA) (Full Scale = 25 mA) LEVEL_SET = 000010</th> <th>Current (mA) (Full Scale = 12.5 mA) LEVEL_SET = 001100</th> <th>Current (mA) (Full Scale = 8.25 mA) LEVEL_SET = 010110</th> <th>Current (mA) (Full Scale = 6.25 mA) LEVEL_SET = 100000</th> <th>Current (mA) (Full Scale = 5.0 mA) LEVEL_SET = 101010</th> </tr> </thead> <tbody> <tr> <td>0x00</td> <td>0.0</td> <td>0.0</td> <td>0.0</td> <td>0.0</td> <td>0.0</td> </tr> <tr> <td>0x01</td> <td>0.0016</td> <td>0.0008</td> <td>0.0005</td> <td>0.0004</td> <td>0.0003</td> </tr> <tr> <td>0x02</td> <td>0.0062</td> <td>0.0031</td> <td>0.0021</td> <td>0.0016</td> <td>0.0012</td> </tr> <tr> <td>0x03</td> <td>0.014</td> <td>0.0070</td> <td>0.0047</td> <td>0.0035</td> <td>0.0028</td> </tr> <tr> <td>...</td> <td>...</td> <td>...</td> <td>...</td> <td>...</td> <td>...</td> </tr> <tr> <td>0x7F</td> <td>25.0</td> <td>12.5</td> <td>8.33</td> <td>6.25</td> <td>5.0</td> </tr> </tbody> </table>	DAC Code	Current (mA) (Full Scale = 25 mA) LEVEL_SET = 000010	Current (mA) (Full Scale = 12.5 mA) LEVEL_SET = 001100	Current (mA) (Full Scale = 8.25 mA) LEVEL_SET = 010110	Current (mA) (Full Scale = 6.25 mA) LEVEL_SET = 100000	Current (mA) (Full Scale = 5.0 mA) LEVEL_SET = 101010	0x00	0.0	0.0	0.0	0.0	0.0	0x01	0.0016	0.0008	0.0005	0.0004	0.0003	0x02	0.0062	0.0031	0.0021	0.0016	0.0012	0x03	0.014	0.0070	0.0047	0.0035	0.0028	0x7F	25.0	12.5	8.33	6.25	5.0
DAC Code	Current (mA) (Full Scale = 25 mA) LEVEL_SET = 000010	Current (mA) (Full Scale = 12.5 mA) LEVEL_SET = 001100	Current (mA) (Full Scale = 8.25 mA) LEVEL_SET = 010110	Current (mA) (Full Scale = 6.25 mA) LEVEL_SET = 100000	Current (mA) (Full Scale = 5.0 mA) LEVEL_SET = 101010																																							
0x00	0.0	0.0	0.0	0.0	0.0																																							
0x01	0.0016	0.0008	0.0005	0.0004	0.0003																																							
0x02	0.0062	0.0031	0.0021	0.0016	0.0012																																							
0x03	0.014	0.0070	0.0047	0.0035	0.0028																																							
...																																							
0x7F	25.0	12.5	8.33	6.25	5.0																																							

Independent Sink Current LED7—Even Heartbeat Pulses (ISC7_HB)—Register 0x2E

Table 80. ISC7_HB Bit Map

Bit 7	Bit 6	Bit 5	Bit 4	Bit 3	Bit 2	Bit 1	Bit 0
Reserved	SCD7_HB						

Table 81.

Bit Name	Bit No.	Description																																										
N/A	7	Reserved.																																										
SCD7_HB	[6:0]	Sink current for the even numbered pulses when heartbeat mode for this channel is enabled. Use the following DAC code schedule. See Table 39 for a complete list of values.																																										
		<table border="1"> <thead> <tr> <th>DAC Code</th> <th>Current (mA) (Full Scale = 25 mA) LEVEL_SET = 000010</th> <th>Current (mA) (Full Scale = 12.5 mA) LEVEL_SET = 001100</th> <th>Current (mA) (Full Scale = 8.25 mA) LEVEL_SET = 010110</th> <th>Current (mA) (Full Scale = 6.25 mA) LEVEL_SET = 100000</th> <th>Current (mA) (Full Scale = 5.0 mA) LEVEL_SET = 101010</th> </tr> </thead> <tbody> <tr> <td>0x00</td> <td>0.0</td> <td>0.0</td> <td>0.0</td> <td>0.0</td> <td>0.0</td> </tr> <tr> <td>0x01</td> <td>0.0016</td> <td>0.0008</td> <td>0.0005</td> <td>0.0004</td> <td>0.0003</td> </tr> <tr> <td>0x02</td> <td>0.0062</td> <td>0.0031</td> <td>0.0021</td> <td>0.0016</td> <td>0.0012</td> </tr> <tr> <td>0x03</td> <td>0.014</td> <td>0.0070</td> <td>0.0047</td> <td>0.0035</td> <td>0.0028</td> </tr> <tr> <td>...</td> <td>...</td> <td>...</td> <td>...</td> <td>...</td> <td>...</td> </tr> <tr> <td>0x7F</td> <td>25.0</td> <td>12.5</td> <td>8.33</td> <td>6.25</td> <td>5.0</td> </tr> </tbody> </table>	DAC Code	Current (mA) (Full Scale = 25 mA) LEVEL_SET = 000010	Current (mA) (Full Scale = 12.5 mA) LEVEL_SET = 001100	Current (mA) (Full Scale = 8.25 mA) LEVEL_SET = 010110	Current (mA) (Full Scale = 6.25 mA) LEVEL_SET = 100000	Current (mA) (Full Scale = 5.0 mA) LEVEL_SET = 101010	0x00	0.0	0.0	0.0	0.0	0.0	0x01	0.0016	0.0008	0.0005	0.0004	0.0003	0x02	0.0062	0.0031	0.0021	0.0016	0.0012	0x03	0.014	0.0070	0.0047	0.0035	0.0028	0x7F	25.0	12.5	8.33	6.25	5.0
DAC Code	Current (mA) (Full Scale = 25 mA) LEVEL_SET = 000010	Current (mA) (Full Scale = 12.5 mA) LEVEL_SET = 001100	Current (mA) (Full Scale = 8.25 mA) LEVEL_SET = 010110	Current (mA) (Full Scale = 6.25 mA) LEVEL_SET = 100000	Current (mA) (Full Scale = 5.0 mA) LEVEL_SET = 101010																																							
0x00	0.0	0.0	0.0	0.0	0.0																																							
0x01	0.0016	0.0008	0.0005	0.0004	0.0003																																							
0x02	0.0062	0.0031	0.0021	0.0016	0.0012																																							
0x03	0.014	0.0070	0.0047	0.0035	0.0028																																							
...																																							
0x7F	25.0	12.5	8.33	6.25	5.0																																							

Independent Sink Current LED8—Even Heartbeat Pulses (ISC8_HB)—Register 0x2F

Table 82. ISC8_HB Bit Map

Bit 7	Bit 6	Bit 5	Bit 4	Bit 3	Bit 2	Bit 1	Bit 0
Reserved	SCD8_HB						

Table 83.

Bit Name	Bit No.	Description																																										
N/A	7	Reserved.																																										
SCD8_HB	[6:0]	Sink current for the even numbered pulses when heartbeat mode for this channel is enabled. Use the following DAC code schedule. See Table 39 for a complete list of values.																																										
		<table border="1"> <thead> <tr> <th>DAC Code</th> <th>Current (mA) (Full Scale = 25 mA) LEVEL_SET = 000010</th> <th>Current (mA) (Full Scale = 12.5 mA) LEVEL_SET = 001100</th> <th>Current (mA) (Full Scale = 8.25 mA) LEVEL_SET = 010110</th> <th>Current (mA) (Full Scale = 6.25 mA) LEVEL_SET = 100000</th> <th>Current (mA) (Full Scale = 5.0 mA) LEVEL_SET = 101010</th> </tr> </thead> <tbody> <tr> <td>0x00</td> <td>0.0</td> <td>0.0</td> <td>0.0</td> <td>0.0</td> <td>0.0</td> </tr> <tr> <td>0x01</td> <td>0.0016</td> <td>0.0008</td> <td>0.0005</td> <td>0.0004</td> <td>0.0003</td> </tr> <tr> <td>0x02</td> <td>0.0062</td> <td>0.0031</td> <td>0.0021</td> <td>0.0016</td> <td>0.0012</td> </tr> <tr> <td>0x03</td> <td>0.014</td> <td>0.0070</td> <td>0.0047</td> <td>0.0035</td> <td>0.0028</td> </tr> <tr> <td>...</td> <td>...</td> <td>...</td> <td>...</td> <td>...</td> <td>...</td> </tr> <tr> <td>0x7F</td> <td>25.0</td> <td>12.5</td> <td>8.33</td> <td>6.25</td> <td>5.0</td> </tr> </tbody> </table>	DAC Code	Current (mA) (Full Scale = 25 mA) LEVEL_SET = 000010	Current (mA) (Full Scale = 12.5 mA) LEVEL_SET = 001100	Current (mA) (Full Scale = 8.25 mA) LEVEL_SET = 010110	Current (mA) (Full Scale = 6.25 mA) LEVEL_SET = 100000	Current (mA) (Full Scale = 5.0 mA) LEVEL_SET = 101010	0x00	0.0	0.0	0.0	0.0	0.0	0x01	0.0016	0.0008	0.0005	0.0004	0.0003	0x02	0.0062	0.0031	0.0021	0.0016	0.0012	0x03	0.014	0.0070	0.0047	0.0035	0.0028	0x7F	25.0	12.5	8.33	6.25	5.0
DAC Code	Current (mA) (Full Scale = 25 mA) LEVEL_SET = 000010	Current (mA) (Full Scale = 12.5 mA) LEVEL_SET = 001100	Current (mA) (Full Scale = 8.25 mA) LEVEL_SET = 010110	Current (mA) (Full Scale = 6.25 mA) LEVEL_SET = 100000	Current (mA) (Full Scale = 5.0 mA) LEVEL_SET = 101010																																							
0x00	0.0	0.0	0.0	0.0	0.0																																							
0x01	0.0016	0.0008	0.0005	0.0004	0.0003																																							
0x02	0.0062	0.0031	0.0021	0.0016	0.0012																																							
0x03	0.014	0.0070	0.0047	0.0035	0.0028																																							
...																																							
0x7F	25.0	12.5	8.33	6.25	5.0																																							

Independent Sink Current LED9—Even Heartbeat Pulses (ISC9_HB)—Register 0x30

Table 84. ISC9_HB Bit Map

Bit 7	Bit 6	Bit 5	Bit 4	Bit 3	Bit 2	Bit 1	Bit 0
Reserved	SCD9_HB						

Table 85.

Bit Name	Bit No.	Description																																										
N/A	7	Reserved.																																										
SCD9_HB	[6:0]	Sink current for the even numbered pulses when heartbeat mode for this channel is enabled. Use the following DAC code schedule. See Table 39 for a complete list of values.																																										
		<table border="1"> <thead> <tr> <th>DAC Code</th> <th>Current (mA) (Full Scale = 25 mA) LEVEL_SET = 000010</th> <th>Current (mA) (Full Scale = 12.5 mA) LEVEL_SET = 001100</th> <th>Current (mA) (Full Scale = 8.25 mA) LEVEL_SET = 010110</th> <th>Current (mA) (Full Scale = 6.25 mA) LEVEL_SET = 100000</th> <th>Current (mA) (Full Scale = 5.0 mA) LEVEL_SET = 101010</th> </tr> </thead> <tbody> <tr> <td>0x00</td> <td>0.0</td> <td>0.0</td> <td>0.0</td> <td>0.0</td> <td>0.0</td> </tr> <tr> <td>0x01</td> <td>0.0016</td> <td>0.0008</td> <td>0.0005</td> <td>0.0004</td> <td>0.0003</td> </tr> <tr> <td>0x02</td> <td>0.0062</td> <td>0.0031</td> <td>0.0021</td> <td>0.0016</td> <td>0.0012</td> </tr> <tr> <td>0x03</td> <td>0.014</td> <td>0.0070</td> <td>0.0047</td> <td>0.0035</td> <td>0.0028</td> </tr> <tr> <td>...</td> <td>...</td> <td>...</td> <td>...</td> <td>...</td> <td>...</td> </tr> <tr> <td>0x7F</td> <td>25.0</td> <td>12.5</td> <td>8.33</td> <td>6.25</td> <td>5.0</td> </tr> </tbody> </table>	DAC Code	Current (mA) (Full Scale = 25 mA) LEVEL_SET = 000010	Current (mA) (Full Scale = 12.5 mA) LEVEL_SET = 001100	Current (mA) (Full Scale = 8.25 mA) LEVEL_SET = 010110	Current (mA) (Full Scale = 6.25 mA) LEVEL_SET = 100000	Current (mA) (Full Scale = 5.0 mA) LEVEL_SET = 101010	0x00	0.0	0.0	0.0	0.0	0.0	0x01	0.0016	0.0008	0.0005	0.0004	0.0003	0x02	0.0062	0.0031	0.0021	0.0016	0.0012	0x03	0.014	0.0070	0.0047	0.0035	0.0028	0x7F	25.0	12.5	8.33	6.25	5.0
DAC Code	Current (mA) (Full Scale = 25 mA) LEVEL_SET = 000010	Current (mA) (Full Scale = 12.5 mA) LEVEL_SET = 001100	Current (mA) (Full Scale = 8.25 mA) LEVEL_SET = 010110	Current (mA) (Full Scale = 6.25 mA) LEVEL_SET = 100000	Current (mA) (Full Scale = 5.0 mA) LEVEL_SET = 101010																																							
0x00	0.0	0.0	0.0	0.0	0.0																																							
0x01	0.0016	0.0008	0.0005	0.0004	0.0003																																							
0x02	0.0062	0.0031	0.0021	0.0016	0.0012																																							
0x03	0.014	0.0070	0.0047	0.0035	0.0028																																							
...																																							
0x7F	25.0	12.5	8.33	6.25	5.0																																							

Independent Sink 6 Off Timer—Even Heartbeat Pulses (OFFTIMER6_HB)—Register 0x31

Table 86. OFFTIMER6_HB Bit Map

Bit 7	Bit 6	Bit 5	Bit 4	Bit 3	Bit 2	Bit 1	Bit 0
Reserved	SC6OFF_HB						

Table 87.

Bit Name	Bit No.	Description
N/A	7	Reserved.
SC6OFF_HB	[6:0]	<p>SC6 off time for the even numbered pulses when heartbeat mode for this channel is enabled. When the SC6OFF_HB time is disabled, SC6 goes immediately from the even numbered on time to the odd numbered on time. When the SC off time is set to any other value, the ISC turns off for the off time (per the following listed times) and then turns on according to the SCON6_HB setting.</p> <p>0000 = disabled¹. 0000001 = 0.0 sec². 0000010 = 0.1 sec. 0000011 = 0.2 sec. ... 1111110 = 12.5 sec. 1111111 = off³.</p>

¹ A disabled setting leaves the LED on. This is useful for setting up a blink sequence that runs once and then stays on.² Setting SCxOFF_HB to 0 seconds is not recommended if the SCFO_HB fade-out time is also set to 0 seconds.³ Setting SCxOFF to off causes the LED to be held off indefinitely. This is useful for setting up a blink sequence that runs once and then goes to off.**Independent Sink 7 Off Timer—Even Heartbeat Pulses (OFFTIMER7_HB)—Register 0x32**

Table 88. OFFTIMER7_HB Bit Map

Bit 7	Bit 6	Bit 5	Bit 4	Bit 3	Bit 2	Bit 1	Bit 0
Reserved	SC7OFF_HB						

Table 89.

Bit Name	Bit No.	Description
N/A	7	Reserved.
SC7OFF_HB	[6:0]	<p>SC7 off time for the even numbered pulses when heartbeat mode for this channel is enabled. When the SC7OFF_HB time is disabled, SC7 goes immediately from the even numbered on time to the odd numbered on time. When the SC off time is set to any other value, the ISC turns off for the off time (per the following listed times) and then turns on according to the SCON7_HB setting.</p> <p>0000 = disabled¹. 0000001 = 0.0 sec². 0000010 = 0.1 sec. 0000011 = 0.2 sec. ... 1111110 = 12.5 sec. 1111111 = off³.</p>

¹ A disabled setting leaves the LED on. This is useful for setting up a blink sequence that runs once and then stays on.

² Setting SCxOFF_HB to 0 seconds is not recommended if the SCFO_HB fade-out time is also set to 0 seconds.

³ Setting SCxOFF to off causes the LED to be held off indefinitely. This is useful for setting up a blink sequence that runs once and then goes to off.

Independent Sink 8 Off Timer—Even Heartbeat Pulses (OFFTIMER8_HB)—Register 0x33

Table 90. OFFTIMER8_HB Bit Map

Bit 7	Bit 6	Bit 5	Bit 4	Bit 3	Bit 2	Bit 1	Bit 0
Reserved	SC8OFF_HB						

Table 91.

Bit Name	Bit No.	Description
N/A	7	Reserved.
SC8OFF_HB	[6:0]	<p>SC8 off time for the even numbered pulses when heartbeat mode for this channel is enabled. When the SC8OFF_HB time is disabled, SC8 goes immediately from the even numbered on time to the odd numbered on time. When the SC off time is set to any other value, the ISC turns off for the off time (per the following listed times) and then turns on according to the SCON8_HB setting.</p> <p>0000 = disabled¹. 0000001 = 0.0 sec². 0000010 = 0.1 sec. 0000011 = 0.2 sec. ... 1111110 = 12.5 sec. 1111111 = off³.</p>

¹ A disabled setting leaves the LED on. This is useful for setting up a blink sequence that runs once and then stays on.

² Setting SCxOFF_HB to 0 seconds is not recommended if the SCFO_HB fade-out time is also set to 0 seconds.

³ Setting SCxOFF to off causes the LED to be held off indefinitely. This is useful for setting up a blink sequence that runs once and then goes to off.

Independent Sink 9 Off Timer—Even Heartbeat Pulses (OFFTIMER9_HB)—Register 0x34

Table 92. OFFTIMER9_HB Bit Map

Bit 7	Bit 6	Bit 5	Bit 4	Bit 3	Bit 2	Bit 1	Bit 0
Reserved	SC9OFF_HB						

Table 93.

Bit Name	Bit No.	Description
N/A	7	Reserved.
SC9OFF_HB	[6:0]	SC9 off time for the even numbered pulses when heartbeat mode for this channel is enabled. When the SC9OFF_HB time is disabled, SC9 goes immediately from the even numbered on time to the odd numbered on time. When the SC off time is set to any other value, the ISC turns off for the off time (per the following listed times) and then turns on according to the SCON9_HB setting. 0000 = disabled ¹ . 0000001 = 0.0 sec ² . 0000010 = 0.1 sec. 0000011 = 0.2 sec. ... 1111110 = 12.5 sec. 1111111 = off ³ .

¹ A disabled setting leaves the LED on. This is useful for setting up a blink sequence that runs once and then stays on.

² Setting SCxOFF_HB to 0 seconds is not recommended if the SCFO_HB fade-out time is also set to 0 seconds.

³ Setting SCxOFF to off causes the LED to be held off indefinitely. This is useful for setting up a blink sequence that runs once and then goes to off.

Heartbeat On Time (ISCT_HB)—Register 0x35

Table 94. ISCTHB1 Bit Map

Bit 7	Bit 6	Bit 5	Bit 4	Bit 3	Bit 2	Bit 1	Bit 0
Reserved				SCON_HB			

Table 95.

Bit Name	Bit No.	Description
N/A	[7:4]	Reserved.
SCON_HB	[3:0]	On time for D6 to D9 even numbered pulses, when heartbeat is enabled for those channels. 0000 = 0.00 sec. 0001 = 0.05 sec. 0010 = 0.10 sec. 0011 = 0.15 sec. 0100 = 0.20 sec. 0101 = 0.25 sec. 0110 = 0.30 sec. 0111 = 0.35 sec. 1000 = 0.40 sec. 1001 = 0.45 sec. 1010 = 0.50 sec. 1011 = 0.55 sec. 1100 = 0.60 sec. 1101 = 0.65 sec. 1110 = 0.70 sec. 1111 = 0.75 sec.

Enable Delay Time for SC6 (DELAY6)—Register 0x3C

Table 96. DELAY6 Bit Map

Bit 7	Bit 6	Bit 5	Bit 4	Bit 3	Bit 2	Bit 1	Bit 0
Reserved	DELAY6						

Table 97.

Bit Name	Bit No.	Description
N/A	7	Reserved.
DELAY6	[6:0]	Enable delay time for SC6. When SC6 is enabled, the ADP8866 automatically waits the specified time before starting the SC6 fade-in. 0000 = 0 ms (no delay when SC6 enable is exercised). 0000001 = 10 ms. 0000010 = 20 ms. 0000011 = 30 ms. ... 1111111 = 1270 ms.

Enable Delay Time for SC7 (DELAY7)—Register 0x3D

Table 98. DELAY7 Bit Map

Bit 7	Bit 6	Bit 5	Bit 4	Bit 3	Bit 2	Bit 1	Bit 0
Reserved	DELAY7						

Table 99.

Bit Name	Bit No.	Description
N/A	7	Reserved.
DELAY7	[6:0]	Enable delay time for SC7. When SC7 is enabled, the ADP8866 automatically waits the specified time before starting the SC7 fade-in. 0000 = 0 ms (no delay when SC7 enable is exercised). 0000001 = 10 ms. 0000010 = 20 ms. 0000011 = 30 ms. ... 1111111 = 1270 ms.

Enable DelayTime for SC8 (DELAY8)—Register 0x3E

Table 100. DELAY8 Bit Map

Bit 7	Bit 6	Bit 5	Bit 4	Bit 3	Bit 2	Bit 1	Bit 0
Reserved	DELAY8						

Table 101.

Bit Name	Bit No.	Description
N/A	7	Reserved.
DELAY8	[6:0]	Enable delay time for SC8. When SC8 is enabled, the ADP8866 automatically waits the specified time before starting the SC8 fade-in. 0000 = 0 ms (no delay when SC8 enable is exercised). 0000001 = 10 ms. 0000010 = 20 ms. 0000011 = 30 ms. ... 1111111 = 1270 ms.

Enable Delay Time for SC9 (DELAY9)—Register 0x3F

Table 102. DELAY9 Bit Map

Bit 7	Bit 6	Bit 5	Bit 4	Bit 3	Bit 2	Bit 1	Bit 0
Reserved	DELAY9						

Table 103.

Bit Name	Bit No.	Description
N/A	7	Reserved.
DELAY9	[6:0]	Enable delay time for SC9. When SC9 is enabled, the ADP8866 automatically waits the specified time before starting the SC9 fade-in. 0000 = 0 ms (no delay when SC9 enable is exercised). 0000001 = 10 ms. 0000010 = 20 ms. 0000011 = 30 ms. ... 1111111 = 1270 ms.

OUTLINE DIMENSIONS

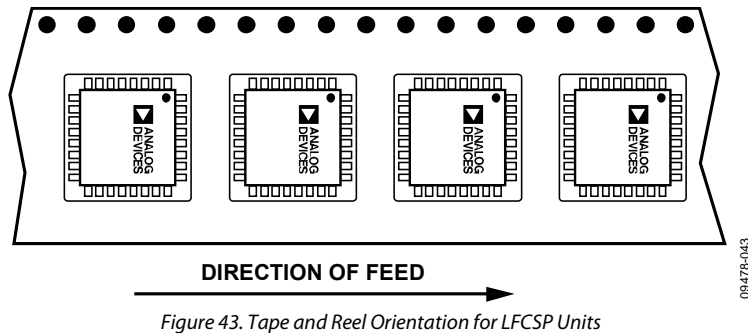
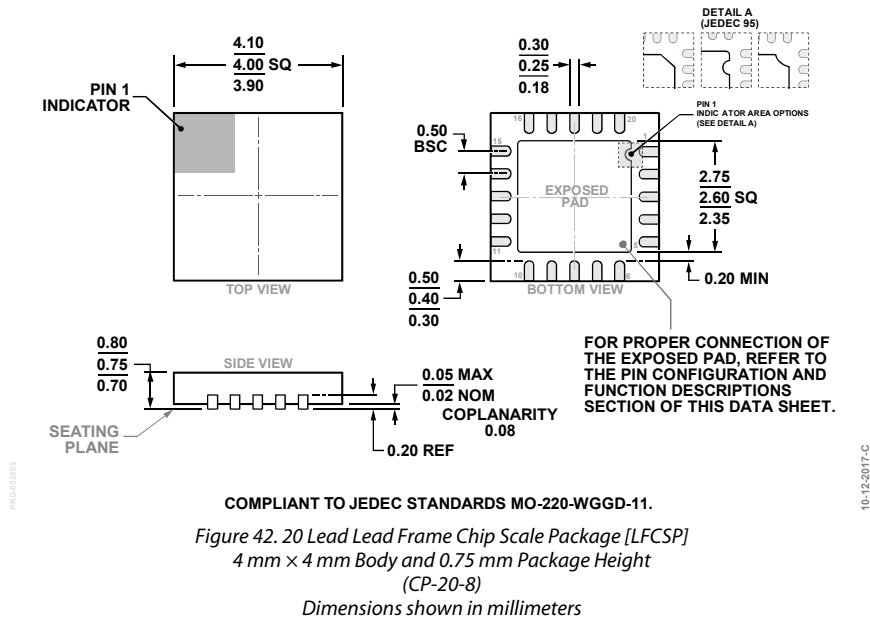

Figure 43. Tape and Reel Orientation for LFCSP Units

ORDERING GUIDE

Model ¹	Temperature Range	Package Description	Package Option
ADP8866ACPZ-R7	-40°C to +105°C	20-Lead LFCSP, 7" Tape and Reel	CP-20-8

¹ Z = RoHS Compliant Part.

NOTES

NOTES

I²C refers to a communications protocol originally developed by Philips Semiconductors (now NXP Semiconductors).