



PART NAME

PRINTED CIRCUIT BOARD

PART No.

EXN-23400-PCB EXN-23401-PCB
EXN-23402-PCB

REV. DATE

10-13-15

DRAWING FOR REFERENCE

WE RESERVE THE RIGHT TO MAKE CHANGES TO OUR STANDARD PRODUCTS. PLEASE CONSULT WITH BUD INDUSTRIES PRIOR TO USING THIS DRAWING FOR DESIGN PURPOSE.

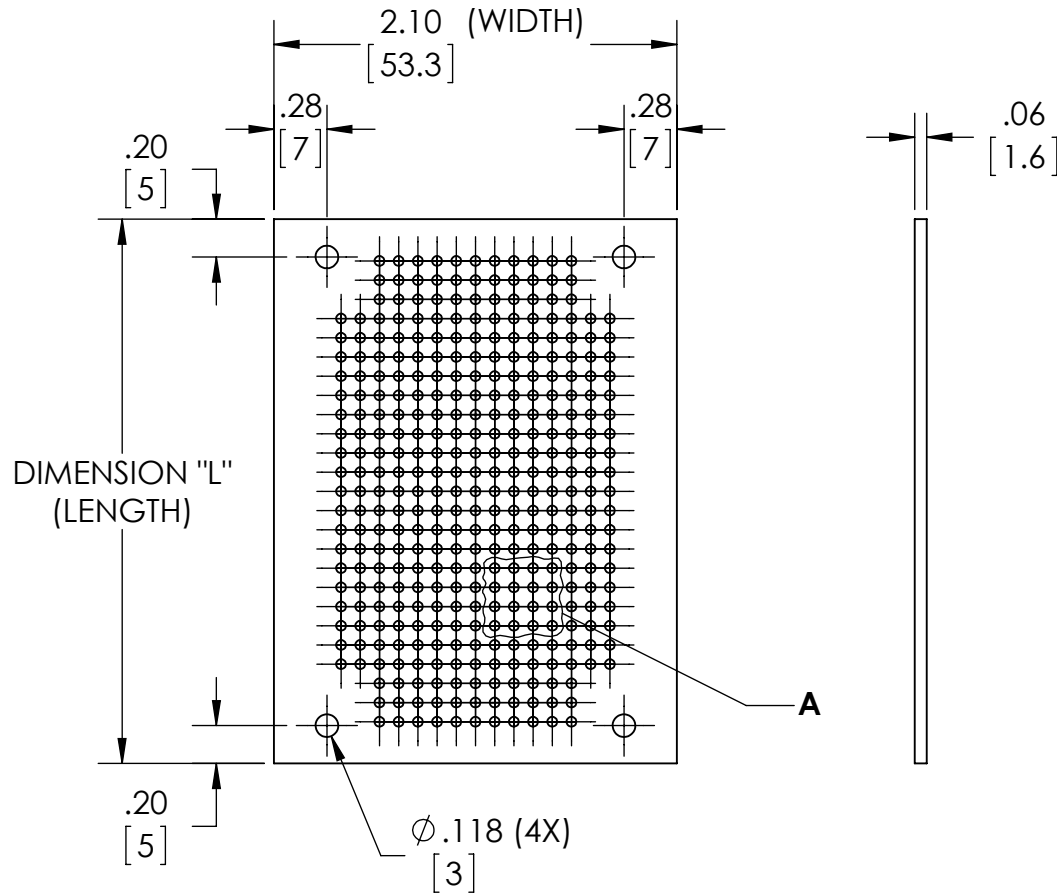

MATERIAL: GREEN SILICON
DIMENSIONS IN INCH[MM]

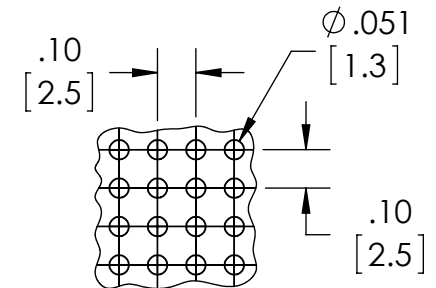

DETAIL A
SCALE 2 : 1

CIRCUIT BOARD PART NUMBER	DIMENSION "L" CIRCUIT BOARD LENGTH	FITS EXN-SERIES ENCLOSURES WITH ALUMINUM END PANELS:	FITS EXN-SERIES ENCLOSURES WITH PLASTIC END PANELS:
EXN-23400-PCB	1.26 [32]	EXN-23350-GD, -SV, -RD, -BL, -BK	EXN-23350-GDP, -SVP, -RDP, -BLP, -BKP
EXN-23401-PCB	2.83 [72]	EXN-23351-GD, -SV, -RD, -BL, -BK	EXN-23351-GDP, -SVP, -RDP, -BLP, -BKP
EXN-23402-PCB	4.41 [112]	EXN-23352-GD, -SV, -RD, -BL, -BK	EXN-23352-GDP, -SVP, -RDP, -BLP, -BKP