



Is Now Part of



**ON Semiconductor®**

To learn more about ON Semiconductor, please visit our website at  
[www.onsemi.com](http://www.onsemi.com)

Please note: As part of the Fairchild Semiconductor integration, some of the Fairchild orderable part numbers will need to change in order to meet ON Semiconductor's system requirements. Since the ON Semiconductor product management systems do not have the ability to manage part nomenclature that utilizes an underscore (\_), the underscore (\_) in the Fairchild part numbers will be changed to a dash (-). This document may contain device numbers with an underscore (\_). Please check the ON Semiconductor website to verify the updated device numbers. The most current and up-to-date ordering information can be found at [www.onsemi.com](http://www.onsemi.com). Please email any questions regarding the system integration to [Fairchild\\_questions@onsemi.com](mailto:Fairchild_questions@onsemi.com).

ON Semiconductor and the ON Semiconductor logo are trademarks of Semiconductor Components Industries, LLC dba ON Semiconductor or its subsidiaries in the United States and/or other countries. ON Semiconductor owns the rights to a number of patents, trademarks, copyrights, trade secrets, and other intellectual property. A listing of ON Semiconductor's product/patent coverage may be accessed at [www.onsemi.com/site/pdf/Patent-Marking.pdf](http://www.onsemi.com/site/pdf/Patent-Marking.pdf). ON Semiconductor reserves the right to make changes without further notice to any products herein. ON Semiconductor makes no warranty, representation or guarantee regarding the suitability of its products for any particular purpose, nor does ON Semiconductor assume any liability arising out of the application or use of any product or circuit, and specifically disclaims any and all liability, including without limitation special, consequential or incidental damages. Buyer is responsible for its products and applications using ON Semiconductor products, including compliance with all laws, regulations and safety requirements or standards, regardless of any support or applications information provided by ON Semiconductor. "Typical" parameters which may be provided in ON Semiconductor data sheets and/or specifications can and do vary in different applications and actual performance may vary over time. All operating parameters, including "Typicals" must be validated for each customer application by customer's technical experts. ON Semiconductor does not convey any license under its patent rights nor the rights of others. ON Semiconductor products are not designed, intended, or authorized for use as a critical component in life support systems or any FDA Class 3 medical devices or medical devices with a same or similar classification in a foreign jurisdiction or any devices intended for implantation in the human body. Should Buyer purchase or use ON Semiconductor products for any such unintended or unauthorized application, Buyer shall indemnify and hold ON Semiconductor and its officers, employees, subsidiaries, affiliates, and distributors harmless against all claims, costs, damages, and expenses, and reasonable attorney fees arising out of, directly or indirectly, any claim of personal injury or death associated with such unintended or unauthorized use, even if such claim alleges that ON Semiconductor was negligent regarding the design or manufacture of the part. ON Semiconductor is an Equal Opportunity/Affirmative Action Employer. This literature is subject to all applicable copyright laws and is not for resale in any manner.



January 2016

# FJ15603D NPN Silicon Transistor

## Applications

- High Voltage and High Speed Power Switch Application
- Electronic Ballast Application

## Features

- Wide Safe Operating Area
- Small Variance in Storage Time
- Built-in Free Wheeling Diode

Equivalent Circuit

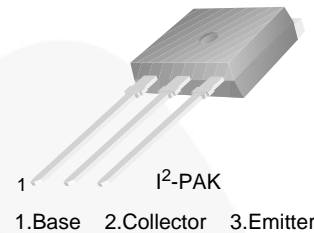
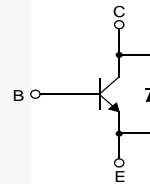

## Ordering Information

Part Number	Marking	Package	Packing Method
FJ15603DTU	J5603D	TO-262 3L (I2PAK)	Rail

## Absolute Maximum Ratings

Stresses exceeding the absolute maximum ratings may damage the device. The device may not function or be operable above the recommended operating conditions and stressing the parts to these levels is not recommended. In addition, extended exposure to stresses above the recommended operating conditions may affect device reliability. The absolute maximum ratings are stress ratings only. Values are at  $T_A = 25^\circ\text{C}$  unless otherwise noted.

Symbol	Parameter	Value	Unit
$V_{CBO}$	Collector-Base Voltage	1600	V
$V_{CEO}$	Collector-Emitter Voltage	800	V
$V_{EBO}$	Emitter-Base Voltage	12	V
$I_C$	Collector Current (DC)	3	A
$I_{CP}$	Collector Current (Pulse) <sup>(1)</sup>	6	A
$I_B$	Base Current (DC)	2	A
$I_{BP}$	Base Current (Pulse) <sup>(1)</sup>	4	A
$P_C$	Power Dissipation ( $T_C = 25^\circ\text{C}$ )	100	W
$T_J$	Junction Temperature	150	$^\circ\text{C}$
$T_{STG}$	Storage Junction Temperature Range	-65 to +150	$^\circ\text{C}$
EAS	Avalanche Energy ( $T_J = 25^\circ\text{C}$ , 8 mH)	3.5	mJ

### Notes:

1. Pulse test: pulse width = 5 ms, duty cycle  $\leq 10\%$

### Thermal Characteristics<sup>(2)</sup>

Values are at  $T_A = 25^\circ\text{C}$  unless otherwise noted.

Symbol	Parameter	Rating	Unit
$R_{\theta JC}$	Thermal Resistance, Junction-to-Case	1.25	$^\circ\text{C/W}$
$R_{\theta JA}$	Thermal Resistance, Junction-to-Ambient	80	$^\circ\text{C/W}$

**Note:**

2. Device mounted on minimum pad size.

### Electrical Characteristics<sup>(3)</sup>

Values are at  $T_A = 25^\circ\text{C}$  unless otherwise noted.

Symbol	Parameter	Conditions	Min.	Typ.	Max.	Unit	
$BV_{CBO}$	Collector-Base Breakdown Voltage	$I_C = 0.5\text{ mA}, I_E = 0$	1600	1689		V	
$BV_{CEO}$	Collector-Emitter Breakdown Voltage	$I_C = 5\text{ mA}, I_B = 0$	800	870		V	
$BV_{EBO}$	Emitter-Base Breakdown Voltage	$I_E = 0.5\text{ mA}, I_C = 0$	12.0	14.8		V	
$I_{CES}$	Collector Cut-Off Current	$V_{CE} = 1600\text{ V}, V_{BE} = 0$	$T_C = 25^\circ\text{C}$	0.01	100	$\mu\text{A}$	
			$T_C = 125^\circ\text{C}$		1000		
$I_{CEO}$	Collector Cut-Off Current	$V_{CE} = 800\text{ V}, I_B = 0$	$T_C = 25^\circ\text{C}$	0.01	100	$\mu\text{A}$	
			$T_C = 125^\circ\text{C}$		1000		
$I_{EBO}$	Emitter Cut-Off Current	$V_{EB} = 12\text{ V}, I_C = 0$		0.05	500	$\mu\text{A}$	
$h_{FE}$	DC Current Gain	$V_{CE} = 3\text{ V}, I_C = 0.4\text{ A}$	$T_C = 25^\circ\text{C}$	20	29	35	
			$T_C = 125^\circ\text{C}$	6	15		
		$V_{CE} = 10\text{ V}, I_C = 5\text{ mA}$	$T_C = 25^\circ\text{C}$	20	43		
			$T_C = 125^\circ\text{C}$	20	46		
$V_{CE(sat)}$	Collector-Emitter Saturation Voltage	$I_C = 250\text{ mA}, I_B = 25\text{ mA}$		0.50	1.25	V	
		$I_C = 500\text{ mA}, I_B = 50\text{ mA}$		1.50	2.50		
		$I_C = 1\text{ A}, I_B = 0.2\text{ A}$		1.20	2.50		
$V_{BE(sat)}$	Base-Emitter Saturation Voltage	$I_C = 500\text{ mA}, I_B = 50\text{ mA}$	$T_C = 25^\circ\text{C}$	0.74	1.20	V	
			$T_C = 125^\circ\text{C}$	0.61	1.10		
		$I_C = 2\text{ A}, I_B = 0.4\text{ A}$	$T_C = 25^\circ\text{C}$	0.85	1.20		
			$T_C = 125^\circ\text{C}$	0.74	1.10		
$C_{ib}$	Input Capacitance	$V_{EB} = 10\text{ V}, I_C = 0, f = 1\text{ MHz}$		745	1000	pF	
$C_{ob}$	Output Capacitance	$V_{CB} = 10\text{ V}, I_E = 0, f = 1\text{ MHz}$		56	500	pF	
$f_T$	Current Gain Bandwidth Product	$I_C = 0.1\text{ A}, V_{CE} = 10\text{ V}$		5		MHz	
$V_F$	Diode Forward Voltage	$I_F = 0.4\text{ A}$		0.76	1.20	V	
		$I_F = 1\text{ A}$		0.83	1.50		

**Note:**

3. Pulse test: pulse width = 20  $\mu\text{s}$ , duty cycle  $\leq 10\%$ .

**Electrical Characteristics** (Continued)Values are at  $T_A = 25^\circ\text{C}$  unless otherwise noted.

Symbol	Parameter	Conditions	Min.	Typ.	Max.	Unit
RESISTIVE LOAD SWITCHING (D.C. $\leq$ 10%, Pulse Width = 20 $\mu\text{s}$ )						
$t_{\text{ON}}$	Turn-On Time	$I_C = 0.3\text{ A}$ , $I_{B1} = 50\text{ mA}$ , $I_{B2} = 150\text{ mA}$ , $V_{CC} = 125\text{ V}$ , $R_L = 416\ \Omega$		400	600	ns
$t_{\text{STG}}$	Storage Time		1.9	2.1	2.3	$\mu\text{s}$
$t_F$	Fall Time			310	1000	ns
$t_{\text{ON}}$	Turn-On Time	$I_C = 0.5\text{ A}$ , $I_{B1} = 50\text{ mA}$ , $I_{B2} = 250\text{ mA}$ , $V_{CC} = 125\text{ V}$ , $R_L = 250\ \Omega$		600	1100	ns
$t_{\text{STG}}$	Storage Time			1.3	1.5	$\mu\text{s}$
$t_F$	Fall Time			180	350	ns
INDUCTIVE LOAD SWITCHING ( $V_{CC} = 15\text{ V}$ )						
$t_{\text{STG}}$	Storage Time	$I_C = 0.3\text{ A}$ , $I_{B1} = 50\text{ mA}$ , $I_{B2} = 150\text{ mA}$ , $V_Z = 300\text{ V}$ , $L_C = 200\text{ H}$	0.8		1.2	$\mu\text{s}$
$t_F$	Fall Time			170	250	ns
$t_C$	Cross-Over Time			180	250	ns
$t_{\text{STG}}$	Storage Time	$I_C = 0.5\text{ A}$ , $I_{B1} = 50\text{ mA}$ , $I_{B2} = 250\text{ mA}$ , $V_Z = 300\text{ V}$ , $L_C = 200\text{ H}$	0.8		1.2	$\mu\text{s}$
$t_F$	Fall Time			140	175	ns
$t_C$	Cross-Over Time			170	200	ns

## Typical Performance Characteristics

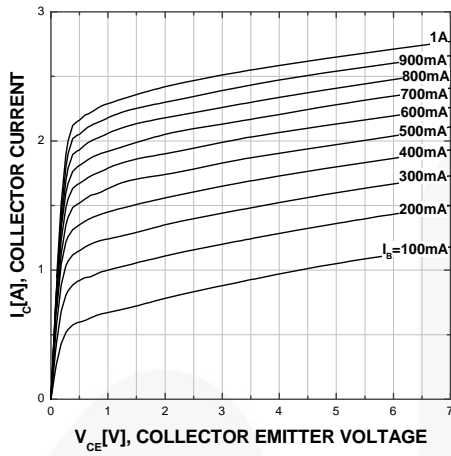

Figure 1. Static Characteristic

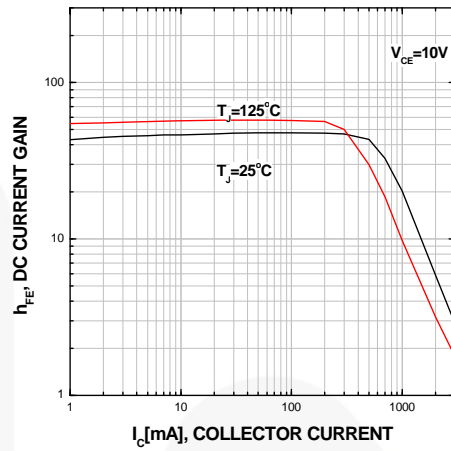

Figure 2. DC Current Gain

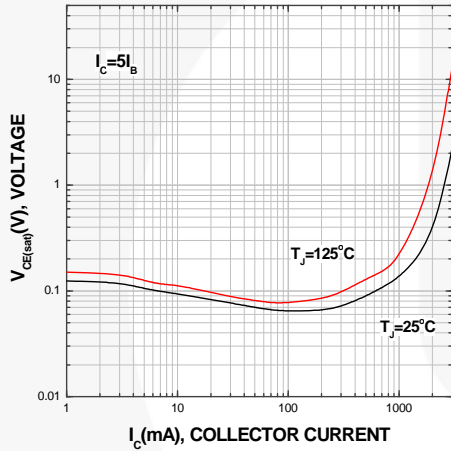

Figure 3. Collector-Emitter Saturation Voltage

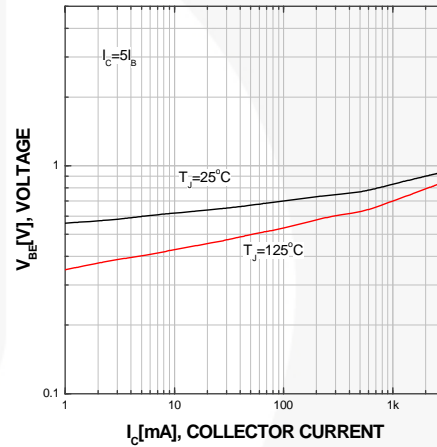

Figure 4. Base-Emitter Saturation Voltage

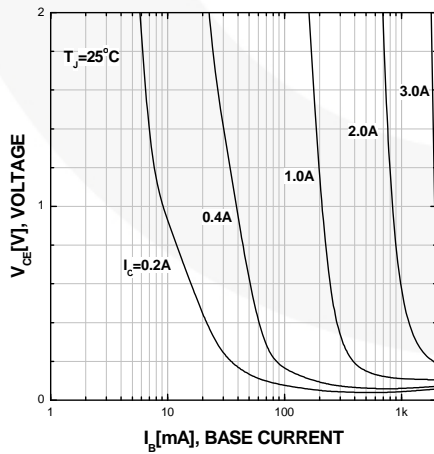

Figure 5. Typical Collector Saturation Voltage

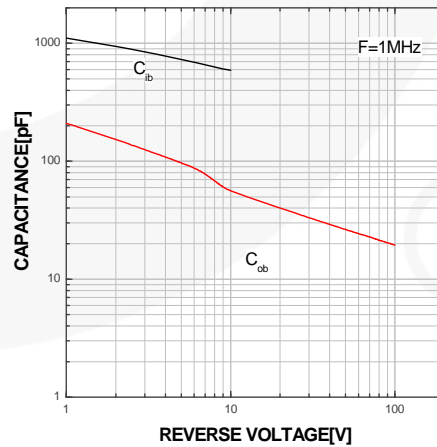

Figure 6. Capacitance

Typical Performance Characteristics (Continued)

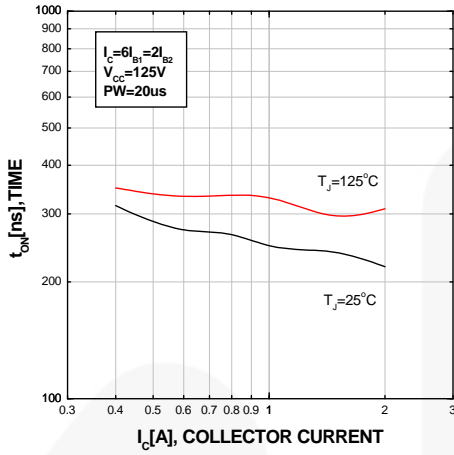

Figure 7. Resistive Switching Time,  $t_{on}$

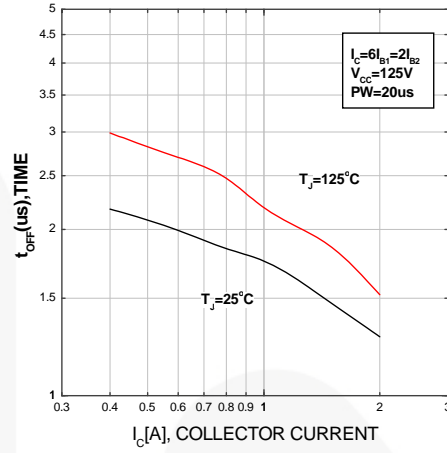

Figure 8. Resistive Switching Time,  $t_{off}$

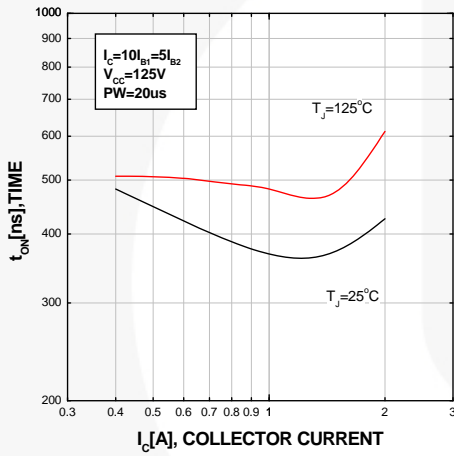

Figure 9. Resistive Switching Time,  $t_{on}$

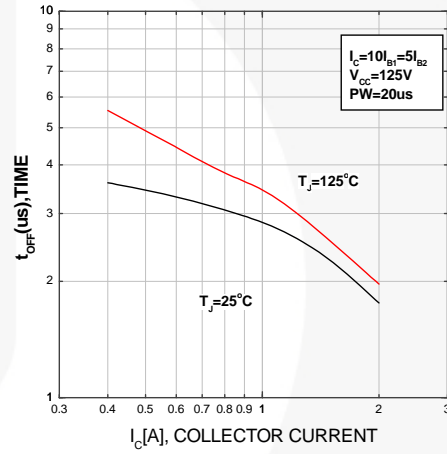

Figure 10. Resistive Switching Time,  $t_{off}$

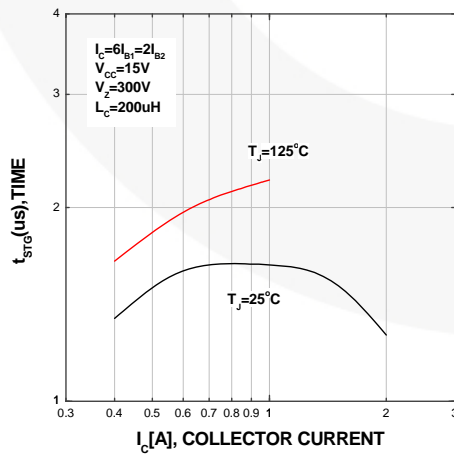

Figure 11. Inductive Switching Time,  $t_{STG}$

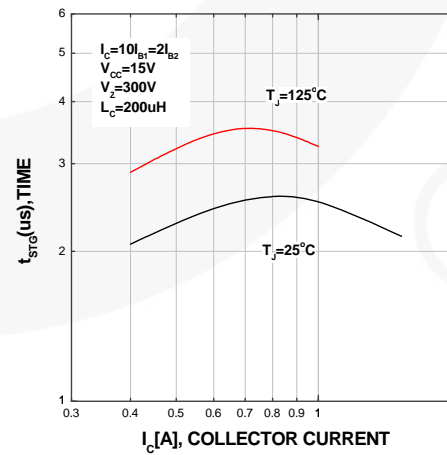

Figure 12. Inductive Switching Time,  $t_{STG}$

Typical Performance Characteristics (Continued)

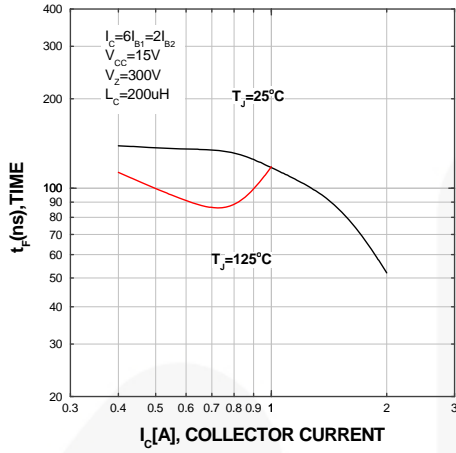

Figure 13. Inductive Switching Time,  $t_f$

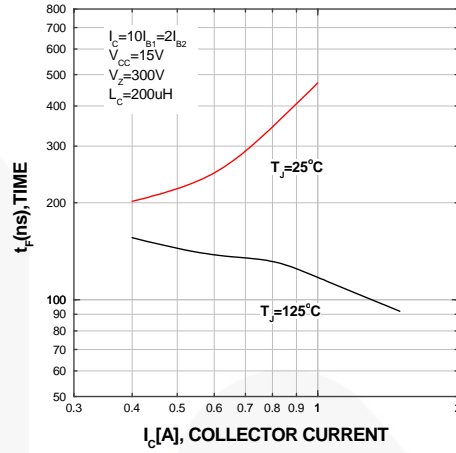

Figure 14. Inductive Switching Time,  $t_f$

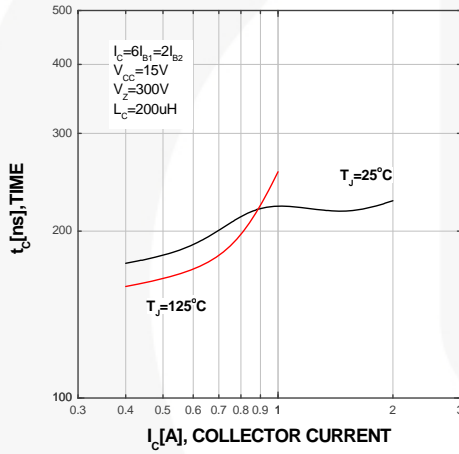

Figure 15. Inductive Switching Time,  $t_c$

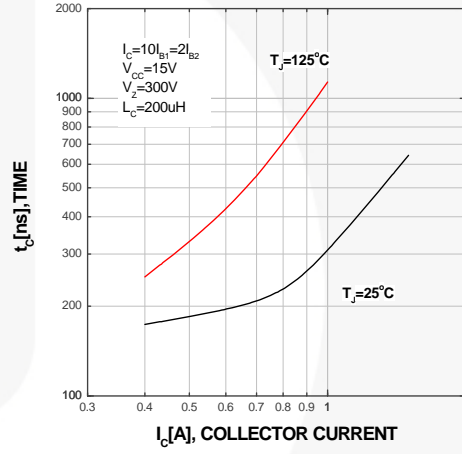

Figure 16. Inductive Switching Time,  $t_c$

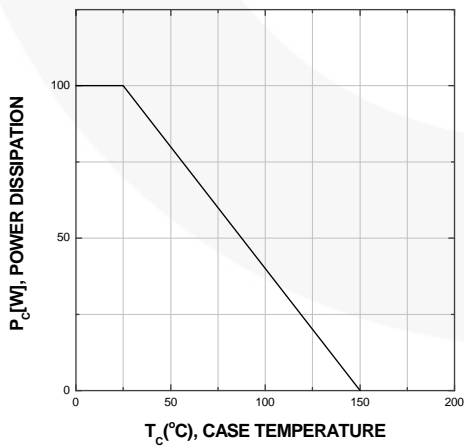
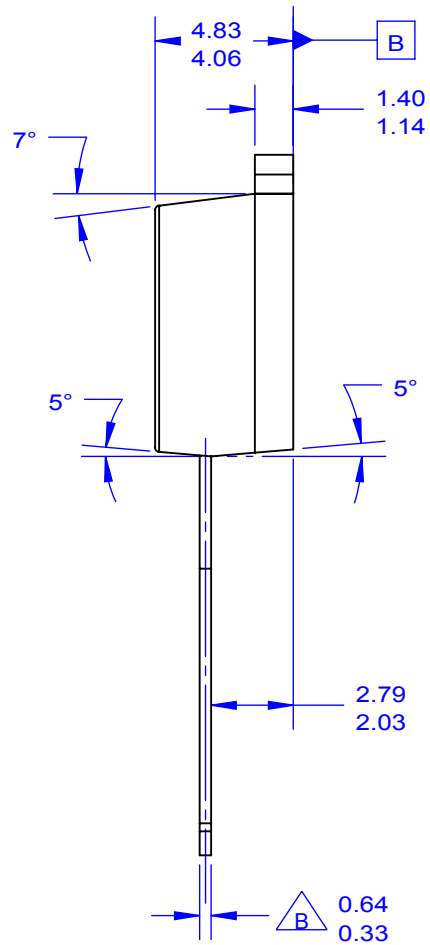
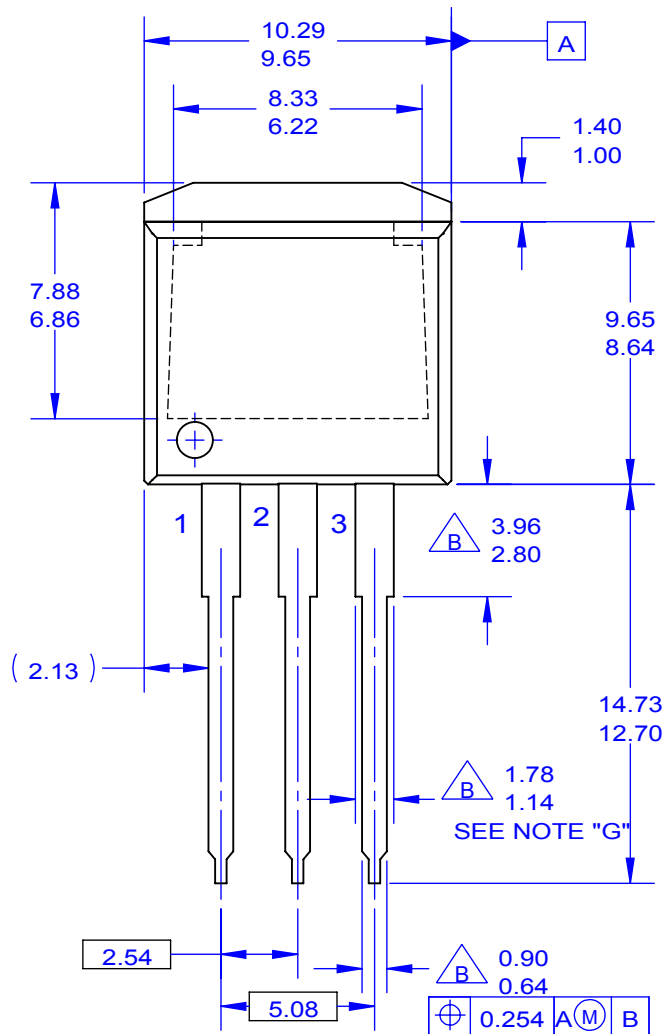

Figure 17. Power Derating



NOTES:

- A. EXCEPT WHERE NOTED CONFORMS TO TO262 JEDEC VARIATION AA.
- B. DOES NOT COMPLY JEDEC STD. VALUE.
- C. ALL DIMENSIONS ARE IN MILLIMETERS.
- D. DIMENSIONS ARE EXCLUSIVE OF BURRS, MOLD FLASH AND TIE BAR PROTRUSIONS.
- E. DIMENSION AND TOLERANCE AS PER ANSI Y14.5-1994.
- F. LOCATION OF PIN HOLE MAY VARY (LOWER LEFT CORNER, LOWER CENTER AND CENTER OF PACKAGE)
- G. MAXIMUM WIDTH FOR F102 DEVICE = 1.35 MAX.
- H. DRAWING FILE NAME: TO262A03REV6





ON Semiconductor and  are trademarks of Semiconductor Components Industries, LLC dba ON Semiconductor or its subsidiaries in the United States and/or other countries. ON Semiconductor owns the rights to a number of patents, trademarks, copyrights, trade secrets, and other intellectual property. A listing of ON Semiconductor's product/patent coverage may be accessed at [www.onsemi.com/site/pdf/Patent-Marking.pdf](http://www.onsemi.com/site/pdf/Patent-Marking.pdf). ON Semiconductor reserves the right to make changes without further notice to any products herein. ON Semiconductor makes no warranty, representation or guarantee regarding the suitability of its products for any particular purpose, nor does ON Semiconductor assume any liability arising out of the application or use of any product or circuit, and specifically disclaims any and all liability, including without limitation special, consequential or incidental damages. Buyer is responsible for its products and applications using ON Semiconductor products, including compliance with all laws, regulations and safety requirements or standards, regardless of any support or applications information provided by ON Semiconductor. "Typical" parameters which may be provided in ON Semiconductor data sheets and/or specifications can and do vary in different applications and actual performance may vary over time. All operating parameters, including "Typicals" must be validated for each customer application by customer's technical experts. ON Semiconductor does not convey any license under its patent rights nor the rights of others. ON Semiconductor products are not designed, intended, or authorized for use as a critical component in life support systems or any FDA Class 3 medical devices or medical devices with a same or similar classification in a foreign jurisdiction or any devices intended for implantation in the human body. Should Buyer purchase or use ON Semiconductor products for any such unintended or unauthorized application, Buyer shall indemnify and hold ON Semiconductor and its officers, employees, subsidiaries, affiliates, and distributors harmless against all claims, costs, damages, and expenses, and reasonable attorney fees arising out of, directly or indirectly, any claim of personal injury or death associated with such unintended or unauthorized use, even if such claim alleges that ON Semiconductor was negligent regarding the design or manufacture of the part. ON Semiconductor is an Equal Opportunity/Affirmative Action Employer. This literature is subject to all applicable copyright laws and is not for resale in any manner.

## PUBLICATION ORDERING INFORMATION

### LITERATURE FULFILLMENT:

Literature Distribution Center for ON Semiconductor  
19521 E. 32nd Pkwy, Aurora, Colorado 80011 USA  
**Phone:** 303-675-2175 or 800-344-3860 Toll Free USA/Canada  
**Fax:** 303-675-2176 or 800-344-3867 Toll Free USA/Canada  
**Email:** [orderlit@onsemi.com](mailto:orderlit@onsemi.com)

**N. American Technical Support:** 800-282-9855 Toll Free  
USA/Canada  
**Europe, Middle East and Africa Technical Support:**  
Phone: 421 33 790 2910  
**Japan Customer Focus Center**  
Phone: 81-3-5817-1050

**ON Semiconductor Website:** [www.onsemi.com](http://www.onsemi.com)  
**Order Literature:** <http://www.onsemi.com/orderlit>  
For additional information, please contact your local  
Sales Representative

# Mouser Electronics

Authorized Distributor

Click to View Pricing, Inventory, Delivery & Lifecycle Information:

[ON Semiconductor:](#)

[FJI5603DTU](#)