

Fully Integrated Switch-Mode Charger With USB Compliance and USB-OTG Support

Check for Samples: [bq24157](#)

FEATURES

- Power Up System without Battery
- Charge Faster than Linear Chargers
- High-Accuracy Voltage and Current Regulation
 - Input Current Regulation Accuracy: $\pm 5\%$ (100 mA and 500 mA)
 - Charge Voltage Regulation Accuracy: $\pm 0.5\%$ (25°C), $\pm 1\%$ (0°C to 125°C)
 - Charge Current Regulation Accuracy: $\pm 5\%$
- Input Voltage Based Dynamic Power Management (VIN DPM)
- Bad Adaptor Detection and Rejection
- Safety Limit Register for Maximum Charge Voltage and Current Limiting
- High-Efficiency Mini-USB/AC Battery Charger for Single-Cell Li-Ion and Li-Polymer Battery Packs
- 20-V Absolute Maximum Input Voltage Rating
- 6.5-V Maximum Operating Input Voltage
- Built-In Input Current Sensing and Limiting
- Integrated Power FETs for Up To 1.25-A Charge Rate
- Programmable Charge Parameters through I²C™ Compatible Interface (up to 3.4 Mbps):
 - Input Current Limit
 - VIN DPM Threshold
 - Fast-Charge/Termination Current
 - Charge Regulation Voltage (3.5 V to 4.44 V)
 - Low Charge Current Mode Enable/Disable
 - Termination Enable/Disable
- Synchronous Fixed-Frequency PWM Controller Operating at 3 MHz With 0% to 99.5% Duty Cycle
- Automatic High Impedance Mode for Low Power Consumption
- Robust Protection
 - Reverse Leakage Protection Prevents Battery Drainage
 - Thermal Regulation and Protection
 - Input/Output Overvoltage Protection
- Status Output for Charging and Faults
- USB Friendly Boot-Up Sequence
- Automatic Charging
- Boost Mode Operation for USB OTG
 - Input Voltage Range (from Battery): 3.2 V to 4.5 V
- 2.1 mm x 2 mm 20-Pin WCSP Package

APPLICATIONS

- Mobile and Smart Phones
- MP3 Players
- Handheld Devices

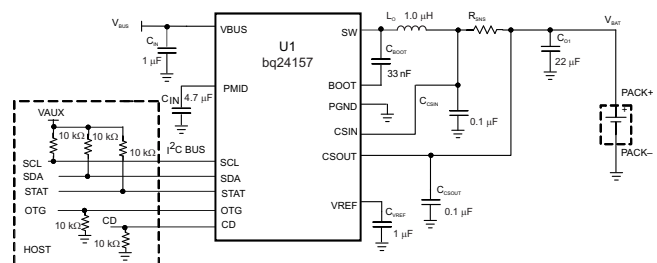
Figure 1. Typical Application Circuit

Please be aware that an important notice concerning availability, standard warranty, and use in critical applications of Texas Instruments semiconductor products and disclaimers thereto appears at the end of this data sheet.

NanoFree is a trademark of Texas Instruments.

I²C is a trademark of NXP B.V. Corporation.

PRODUCTION DATA information is current as of publication date. Products conform to specifications per the terms of the Texas Instruments standard warranty. Production processing does not necessarily include testing of all parameters.

bq24157

SLUSB80A – SEPTEMBER 2012 – REVISED MARCH 2013

www.ti.com

These devices have limited built-in ESD protection. The leads should be shorted together or the device placed in conductive foam during storage or handling to prevent electrostatic damage to the MOS gates.

DESCRIPTION

The bq24157 is a compact, flexible, high-efficiency, USB-friendly switch-mode charge management device for single-cell Li-ion and Li-polymer batteries used in a wide range of portable applications. The charge parameters can be programmed through an I²C interface. The IC integrates a synchronous PWM controller, power MOSFETs, input current sensing, high-accuracy current and voltage regulation, and charge termination, into a small WCSP package.

The IC charges the battery in three phases: conditioning, constant current and constant voltage. The input current is automatically limited to the value set by the host. Charge is terminated based on battery voltage and user-selectable minimum current level. A safety timer with reset control provides a safety backup for I²C interface. During normal operation, The IC automatically restarts the charge cycle if the battery voltage falls below an internal threshold and automatically enters sleep mode or high impedance mode when the input supply is removed. The charge status can be reported to the host using the I²C interface. During the charging process, the IC monitors its junction temperature (T_J) and reduces the charge current once T_J increases to about 125°C. To support USB OTG device, bq24157 can provide VBUS (5.05V) by boosting the battery voltage. The IC is available in 20-pin WCSP package.

DEVICE SPINS AND COMPARISONS

PART NUMBER	bq24157
VOVP (V)	6.5
D4 Pin Definition	OTG
I _{CHARGE(MAX)} at POR in default mode with R _(SNS) = 68 mΩ and OTG=High on bq24157(mA)	325
I _{CHARGE(MAX)} in HOST mode with R _(SNS) = 68 mΩ and Safety Limit Register increased from default (A)	1.25
Output regulation voltage at POR (V)	3.54
Boost Function	Yes
Input Current Limit in Default Mode	100mA (OTG=LOW); 500mA (OTG=High)
Battery Detection at Power Up	No
I2C Address	6AH
PN1 (bit4 of 03H)	1
PN0 (bit3 of 03H)	0
Safety Timer and WD Timer	Disabled
100 ms Power Up Delay	No

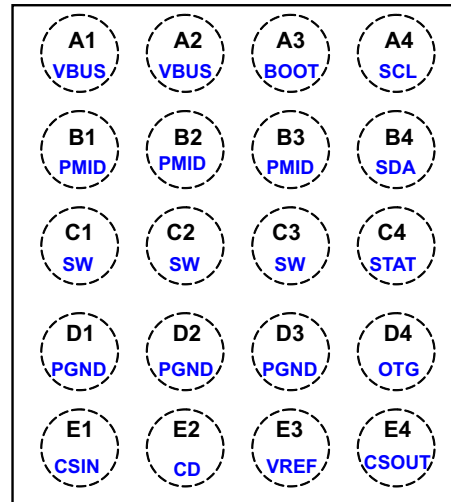
PIN LAYOUT (20-Bump YFF Package)
bq24157
(Top View)

PIN FUNCTIONS

PIN		I/O	DESCRIPTION
NAME	NO.		
CSOUT	E4	I	Battery voltage and current sense input. Bypass it with a ceramic capacitor (minimum 0.1 μ F) to PGND if there are long inductive leads to battery.
VBUS	A1, A2	I/O	Charger input voltage. Bypass it with a 1- μ F ceramic capacitor from VBUS to PGND. It also provides power to the load during boost mode.
PMID	B1, B2, B3	I/O	Connection point between reverse blocking FET and high-side switching FET. Bypass it with a minimum of 3.3- μ F capacitor from PMID to PGND.
SW	C1, C2, C3	O	Internal switch to output inductor connection.
BOOT	A3	I/O	Bootstrap capacitor connection for the high-side FET gate driver. Connect a 10-nF ceramic capacitor (voltage rating \geq 10 V) from BOOT pin to SW pin.
PGND	D1, D2, D3		Power ground
CSIN	E1	I	Charge current-sense input. Battery current is sensed across an external sense resistor. A 0.1- μ F ceramic capacitor to PGND is required.
SCL	A4	I	I ² C interface clock. Connect a 10-k Ω pullup resistor to 1.8V rail ($V_{AUX} = V_{CC_HOST}$)
SDA	B4	I/O	I ² C interface data. Connect a 10-k Ω pullup resistor to 1.8V rail ($V_{AUX} = V_{CC_HOST}$)
STAT	C4	O	Charge status pin. Pull low when charge in progress. Open drain for other conditions. During faults, a 128- μ s pulse is sent out. STAT pin can be disabled by the EN_STAT bit in control register. STAT can be used to drive a LED or communicate with a host processor.
VREF	E3	O	Internal bias regulator voltage. Connect a 1 μ F ceramic capacitor from this output to PGND. External load on VREF is not recommended.
CD	E2	I	Charge disable control pin. CD=0, charge is enabled. CD=1, charge is disabled and VBUS pin is high impedance to GND.
OTG	D4	I	Boost mode enable control or input current limiting selection pin. When OTG is in active status, the device is forced to operate in boost mode. It has higher priority over I ² C control and can be disabled using the control register. At POR while in default mode, the OTG pin is used as the input current limiting selection pin. The I ² C register is ignored at startup. When OTG=High, $I_{IN_LIMIT} = 500\text{mA}$ and when OTG = Low, $I_{IN_LIMIT} = 100\text{mA}$.

ORDERING INFORMATION⁽¹⁾

PART NUMBER	MARKING	MEDIUM	QUANTITY
bq24157YFFR	bq24157A	Tape and Reel	3000
bq24157YFFT	bq24157A	Tape and Reel	250

(1) For the most current package and ordering information, see the Package Option Addendum at the end of this document, or see the TI website at www.ti.com.

ABSOLUTE MAXIMUM RATINGS^{(1) (2)}

over operating free-air temperature range (unless otherwise noted)

		bq24157	UNIT
Supply voltage range (with respect to PGND ⁽³⁾)	VBUS; $V_{PMID} \geq V_{BUS} - 0.3\text{ V}$	-2 to 20	V
Input voltage range (with respect to PGND ⁽³⁾)	SCL, SDA, OTG, SLRST, CSIN, CSOUT, CD	-0.3 to 7	V
Output voltage range (with respect to PGND ⁽³⁾)	PMID, STAT	-0.3 to 20	V
	VREF	7	V
	SW, BOOT	-0.7 to 20	V
Voltage difference between CSIN and CSOUT inputs ($V_{(CSIN)} - V_{(CSOUT)}$)		± 7	V
Voltage difference between BOOT and SW inputs ($V_{(BOOT)} - V_{(SW)}$)		-0.3 to 7	V
Voltage difference between VBUS and PMID inputs ($V_{(VBUS)} - V_{(PMID)}$)		-7 to 0.7	V
Voltage difference between PMID and SW inputs ($V_{(PMID)} - V_{(SW)}$)		-0.7 to 20	V
Output sink	STAT	10	mA
Output Current (average)	SW	1.55 ⁽²⁾	A
T _A	Operating free-air temperature range	-30 to 85	°C
T _J	Junction temperature	-40 to 125	°C
T _{stg}	Storage temperature	-45 to 150	°C

- (1) Stresses beyond those listed under *absolute maximum ratings* may cause permanent damage to the device. These are stress ratings only, and functional operation of the device at these or any other conditions beyond those indicated under *recommended operating conditions* is not implied. Exposure to absolute-maximum-rated conditions for extended periods may affect device reliability. All voltage values are with respect to the network ground terminal unless otherwise noted.
- (2) Duty cycle for output current should be less than 50% for 10- year life time when output current is above 1.25A.
- (3) All voltages are with respect to PGND if not specified. Currents are positive into, negative out of the specified terminal, if not specified. Consult Packaging Section of the data sheet for thermal limitations and considerations of packages.

THERMAL INFORMATION

THERMAL METRIC ⁽¹⁾		bq24157	UNITS
		YFF (20 PINS)	
θ_{JA}	Junction-to-ambient thermal resistance	85	°C/W
θ_{JcTop}	Junction-to-case (top) thermal resistance	25	
θ_{JB}	Junction-to-board thermal resistance	55	
Ψ_{JT}	Junction-to-top characterization parameter	4	
Ψ_{JB}	Junction-to-board characterization parameter	50	
θ_{JcBot}	Junction-to-case (bottom) thermal resistance	n/a	

- (1) For more information about traditional and new thermal metrics, see the *IC Package Thermal Metrics* application report, [SPRA953](#).

RECOMMENDED OPERATING CONDITIONS

		MIN	NOM	MAX	UNIT
V _{BUS}	Supply voltage, bq24157	4		6 ⁽¹⁾	V
T _J	Operating junction temperature range	-40		125	°C

- (1) The inherent switching noise voltage spikes should not exceed the absolute maximum rating on either the BOOST or SW pins. A *tight* layout minimizes switching noise.

ELECTRICAL CHARACTERISTICS

Circuit of Figure 2, VBUS = 5 V, HZ_MODE = 0, OPA_MODE = 0 (CD = 0), T_J = –40°C to 125°C, T_J = 25°C for typical values (unless otherwise noted)

PARAMETER		TEST CONDITIONS	MIN	TYP	MAX	UNIT
INPUT CURRENTS						
I _(VBUS)	VBUS supply current control	VBUS > VBUS(min), PWM switching		10		mA
		VBUS > VBUS(min), PWM NOT switching			5	
		0°C < T _J < 85°C, CD=1 or HZ_MODE=1		15	23	μA
I _{lgk}	Leakage current from battery to VBUS pin	0°C < T _J < 85°C, V _(CSOUT) = 4.2 V, High Impedance mode, VBUS = 0 V			5	μA
	Battery discharge current in High Impedance mode, (CSIN, CSOUT, SW pins)	0°C < T _J < 85°C, V _(CSOUT) = 4.2 V, High Impedance mode, V = 0 V, SCL, SDA, OTG = 0 V or 1.8 V			23	μA
VOLTAGE REGULATION						
V _(OREG)	Output regulation voltage programmable range	Operating in voltage regulation, programmable	3.5		4.44	V
	Voltage regulation accuracy	T _A = 25°C	–0.5%		0.5%	
			–1%		1%	
CURRENT REGULATION (FAST CHARGE)						
I _{O(CHARGE)}	Output charge current programmable range	V _(LOWV) ≤ V _(CSOUT) < V _(OREG) , VBUS > V _(SLP) , R _(SNS) = 68 mΩ, LOW_CHG=0, Programmable	550		1250	mA
	Low charge current	V _(LOWV) ≤ V _(CSOUT) < V _(OREG) , VBUS > V _(SLP) , R _(SNS) = 68 mΩ, LOW_CHG=1, OTG=High		325	350	mA
	Regulation accuracy of the voltage across R _(SNS) (for charge current regulation) V _(IREG) = I _{O(CHARGE)} × R _(SNS)	37.4 mV ≤ V _(IREG) < 44.2mV	–3.5%		3.5%	
		44.2 mV ≤ V _(IREG)	–3%		3%	
WEAK BATTERY DETECTION						
V _(LOWV)	Weak battery voltage threshold programmable range ²⁽¹⁾	Adjustable using I ² C control	3.4		3.7	V
	Weak battery voltage accuracy		–5%		5%	
	Hysteresis for V _(LOWV)	Battery voltage falling		100		mV
	Deglintch time for weak battery threshold	Rising voltage, 2-mV over drive, t _{RISE} = 100 ns		30		ms
CD, OTG and SLRST PIN LOGIC LEVEL						
V _{IL}	Input low threshold level				0.4	V
V _{IH}	Input high threshold level		1.3			V
I _(bias)	Input bias current	Voltage on control pin is 5 V			1.0	μA
CHARGE TERMINATION DETECTION						
I _(TERM)	Termination charge current programmable range	V _(CSOUT) > V _(OREG) – V _(RCH) , VBUS > V _(SLP) , R _(SNS) = 68 mΩ, Programmable	50		400	mA
	Deglintch time for charge termination	Both rising and falling, 2-mV overdrive, t _{RISE} , t _{FALL} = 100 ns		30		ms
	Regulation accuracy for termination current across R _(SNS) V _(IREG_TERM) = I _{O(TERM)} × R _(SNS)	3.4 mV ≤ V _(IREG_TERM) ≤ 6.8 mV	–15%		15%	
		6.8 mV < V _(IREG_TERM) ≤ 17 mV	–10%		10%	
		17 mV < V _(IREG_TERM) ≤ 27.2 mV	–5.5%		5.5%	

- (1) While in 15-min mode, if a battery that is charged to a voltage higher than this voltage is inserted, the charger enters Hi-Z mode and awaits I²C commands.

ELECTRICAL CHARACTERISTICS (continued)

 Circuit of [Figure 2](#), V_{BUS} = 5 V, HZ_MODE = 0, OPA_MODE = 0 (CD = 0), T_J = –40°C to 125°C, T_J = 25°C for typical values (unless otherwise noted)

PARAMETER		TEST CONDITIONS	MIN	TYP	MAX	UNIT	
BAD ADAPTOR DETECTION							
V _{IN(min)}	Input voltage lower limit	BAD ADAPTOR DETECTION	3.6	3.8	4.0	V	
	Deglintch time for VBUS rising above V _{IN(min)}	Rising voltage, 2-mV overdrive, t _{RISE} = 100 ns		30		ms	
	Hysteresis for V _{IN(min)}	Input voltage rising	100		200	mV	
I _{SHORT}	Current source to GND	During bad adaptor detection	20	30	40	mA	
t _{INT}	Detection Interval	Input power source detection		2		s	
INPUT BASED DYNAMIC POWER MANAGEMENT							
V _{IN_DPM}	Input Voltage DPM threshold programmable range		4.2		4.76	V	
	VIN DPM threshold accuracy		–3%		1%		
INPUT CURRENT LIMITING							
I _{IN_LIMIT}	Input current limiting threshold	I _{IN} = 100 mA	T _J = 0°C – 125°C	88	93	98	mA
			T _J = –40°C – 125°C	86	93	98	
		I _{IN} = 500 mA	T _J = 0°C – 125°C	450	475	500	mA
			T _J = –40°C – 125°C	440	475	500	
VREF BIAS REGULATOR							
V _{REF}	Internal bias regulator voltage	VBUS > V _{IN(min)} or V _(CSOUT) > V _{BUS(min)} , I _(VREF) = 1 mA, C _(VREF) = 1 μF	2		6.5	V	
	V _{REF} output short current limit			30		mA	
BATTERY RECHARGE THRESHOLD							
V _(RCH)	Recharge threshold voltage	Below V _(OREG)	100	120	150	mV	
	Deglintch time	V _(CSOUT) decreasing below threshold, t _{FALL} = 100 ns, 10-mV overdrive		130		ms	
STAT OUTPUTS							
V _{OL(STAT)}	Low-level output saturation voltage, STAT pin	I _O = 10 mA, sink current			0.55	V	
	High-level leakage current for STAT	Voltage on STAT pin is 5 V			1	μA	
I²C BUS LOGIC LEVELS AND TIMING CHARACTERISTICS							
V _{OL}	Output low threshold level	I _O = 10 mA, sink current			0.4	V	
V _{IL}	Input low threshold level	V _(pull-up) = 1.8 V, SDA and SCL			0.4	V	
V _{IH}	Input high threshold level	V _(pull-up) = 1.8 V, SDA and SCL	1.2			V	
I _(BIAS)	Input bias current	V _(pull-up) = 1.8 V, SDA and SCL			1	μA	
f _(SCL)	SCL clock frequency				3.4	MHz	
BATTERY DETECTION							
I _(DETECT)	Battery detection current before charge done (sink current) ⁽²⁾	Begins after termination detected, V _(CSOUT) ≤ V _(BATREG)		–0.5		mA	
t _{DETECT}	Battery detection time			262		ms	
SLEEP COMPARATOR							
V _(SLP)	Sleep-mode entry threshold, VBUS – V _{CSOUT}	2.3 V ≤ V _(CSOUT) ≤ V _(BATREG) , V _{BUS} falling	0	40	100	mV	
V _(SLP_EXIT)	Sleep-mode exit hysteresis	2.3 V ≤ V _(CSOUT) ≤ V _(BATREG)	140	200	260	mV	
	Deglintch time for VBUS rising above V _(SLP) + V _(SLP_EXIT)	Rising voltage, 2-mV overdrive, t _{RISE} = 100 ns		30		ms	
UNDERVOLTAGE LOCKOUT (UVLO)							
UVLO	IC active threshold voltage	V _{BUS} rising - Exits UVLO	3.05	3.3	3.55	V	
UVLO _(HYS)	IC active hysteresis	V _{BUS} falling below UVLO - Enters UVLO	120	150		mV	
	Power up delay			140		ms	

(2) Bottom N-channel FET always turns on for ~30 ns and then turns off if current is too low.

ELECTRICAL CHARACTERISTICS (continued)

 Circuit of [Figure 2](#), V_{BUS} = 5 V, HZ_MODE = 0, OPA_MODE = 0 (CD = 0), T_J = –40°C to 125°C, T_J = 25°C for typical values (unless otherwise noted)

PARAMETER		TEST CONDITIONS	MIN	TYP	MAX	UNIT
PWM						
	Voltage from BOOT pin to SW pin	During charge or boost operation			6.5	V
	Internal top reverse blocking MOSFET on-resistance	I _{IN(LIMIT)} = 500 mA, Measured from VBUS to PMID		180	250	
	Internal top N-channel Switching MOSFET on-resistance	Measured from PMID to SW, V _{BOOT} – V _{SW} = 4V		120	250	mΩ
	Internal bottom N-channel MOSFET on-resistance	Measured from SW to PGND		110	210	
f _(OSC)	Oscillator frequency			3.0		MHz
	Frequency accuracy		–10%		10%	
D _(MAX)	Maximum duty cycle			99.5%		
D _(MIN)	Minimum duty cycle		0			
	Synchronous mode to non-synchronous mode transition current threshold ⁽³⁾	Low-side MOSFET cycle-by-cycle current sensing		100		mA
CHARGE MODE PROTECTION						
V _{OVP_IN_USB}	Input VBUS OVP threshold voltage	VBUS threshold to turn off converter during charge	6.3	6.5	6.7	V
V _{OVP}	Output OVP threshold voltage	V _(CSOUT) threshold over V _(OREG) to turn off charger during charge	110	117	121	%V _{OREG}
	V _(OVP) hysteresis	Lower limit for V _(CSOUT) falling from above V _(OVP)		11		
I _{LIMIT}	Cycle-by-cycle current limit for charge	Charge mode operation	1.8	2.4	3.0	A
V _{SHORT}	Trickle to fast charge threshold	V _(CSOUT) rising	2.0	2.1	2.2	V
	V _{SHORT} hysteresis	V _(CSOUT) falling below V _{SHORT}		100		mV
I _{SHORT}	Trickle charge charging current	V _(CSOUT) ≤ V _{SHORT}	20	30	40	mA
BOOST MODE OPERATION FOR V_{BUS} (OPA_MODE = 1, HZ_MODE = 0)						
V _{BUS_B}	Boost output voltage (to VBUS pin)	2.5V < V _(CSOUT) < 4.5 V		5.05		V
	Boost output voltage accuracy	Including line and load regulation	–3%		3%	
I _{BO}	Maximum output current for boost	V _{BUS_B} = 5.05 V, 2.5 V < V _(CSOUT) < 4.5 V, T _J = 0°C – 125°C	200			mA
I _{BLIMIT}	Cycle by cycle current limit for boost	V _{BUS_B} = 5.05 V, 2.5 V < V _(CSOUT) < 4.5 V		1.0		A
V _{BUSOVP}	Overvoltage protection threshold for boost (VBUS pin)	Threshold over VBUS to turn off converter during boost	5.8	6.0	6.2	V
	V _{BUSOVP} hysteresis	V _{BUS} falling from above V _{BUSOVP}		162		mV
V _{BATMAX}	Maximum battery voltage for boost (CSOUT pin)	V _(CSOUT) rising edge during boost	4.75	4.9	5.05	V
	V _{BATMAX} hysteresis	V _(CSOUT) falling from above V _{BATMAX}		200		mV
V _{BATMIN}	Minimum battery voltage for boost (CSOUT pin)	During boosting		2.5		V
		Before boost starts		2.9	3.05	V
	Boost output resistance at high-impedance mode (From VBUS to PGND)	CD = 1 or HZ_MODE = 1	217			kΩ
PROTECTION						
T _{SHTDWN}	Thermal trip			165		°C
	Thermal hysteresis			10		
T _{CF}	Thermal regulation threshold	Charge current begins to reduce		120		
t _{15M}	15 minute safety timer	15 Minute mode		12	15	m

(3) Bottom N-channel FET always turns on for ~30 ns and then turns off if current is too low.

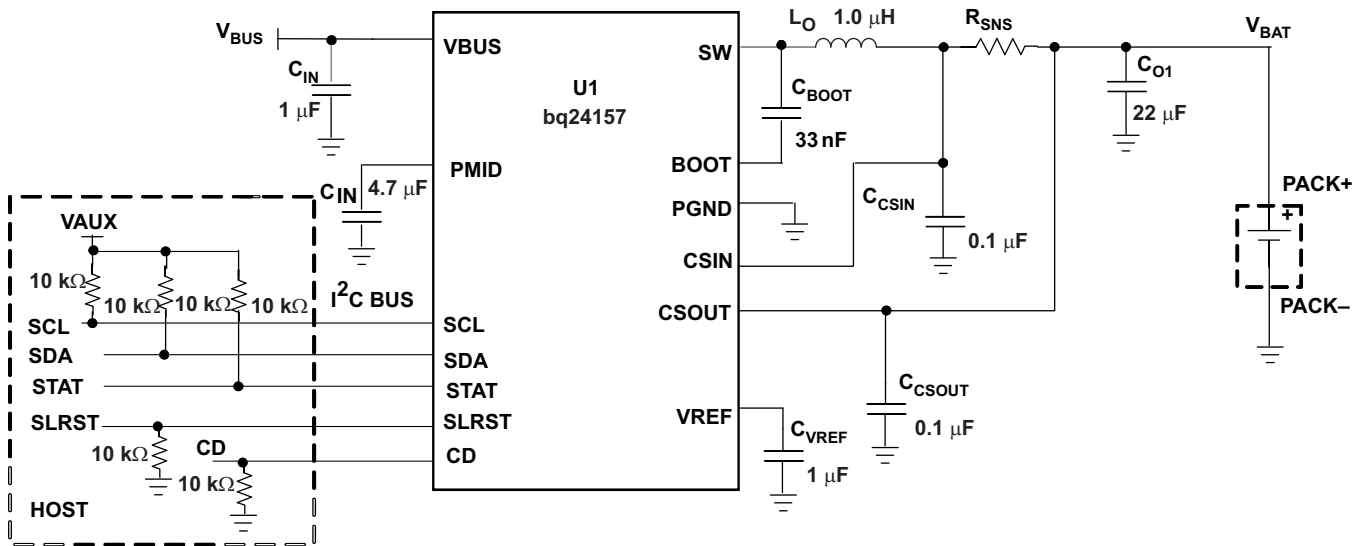
TYPICAL APPLICATION CIRCUITS
 $V_{BUS} = 5\text{ V}$, $I_{CHARGE} = 1250\text{ mA}$, $V_{BAT} = 3.5\text{ V to } 4.44\text{ V}$ (Adjustable).

Figure 2. I²C Controlled 1-Cell USB Charger Application Circuit with USB OTG Support.

TYPICAL PERFORMANCE CHARACTERISTICS

Using circuit shown in Figure 2, $T_A = 25^\circ\text{C}$, unless otherwise specified.

ADAPTER INSERTION

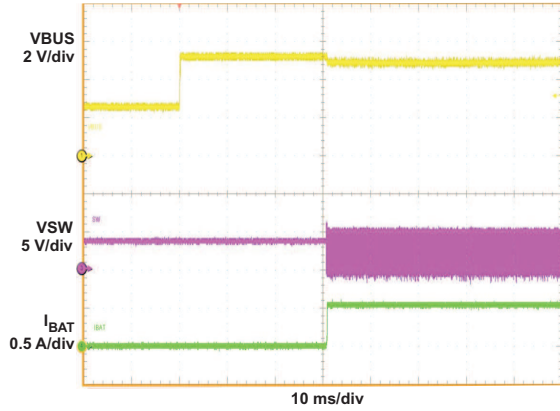

Figure 3. $V_{BUS} = 0-5\text{V}$, $I_{in_limit} = 500\text{mA}$, $V_{oreg} = 4.2\text{V}$, $V_{BAT} = 3.5\text{V}$, $I_{CHG} = 550\text{mA}$, 32S mode

CYCLE BY CYCLE CURRENT LIMITING IN CHARGE MODE

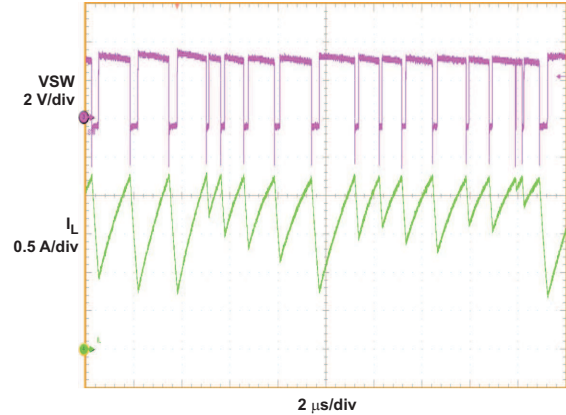

Figure 4. $V_{BUS} = 5\text{V}$, $V_{BAT} = 3.5\text{V}$ Charge Mode Overload Operation

PWM CHARGING WAVEFORMS

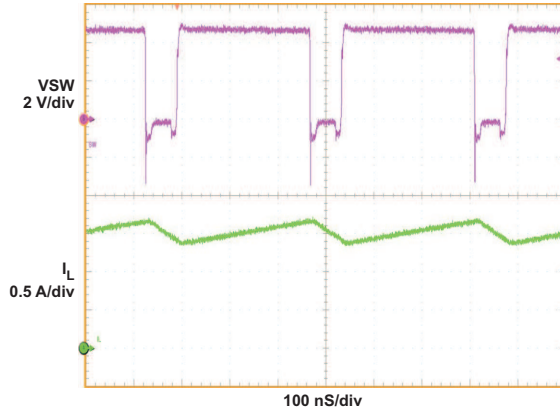

Figure 5. $V_{BUS} = 5\text{V}$, $V_{BAT} = 2.6\text{V}$, $V_{oreg} = 4.2\text{V}$, $I_{CHG} = 1550\text{mA}$

POOR SOURCE DETECTION

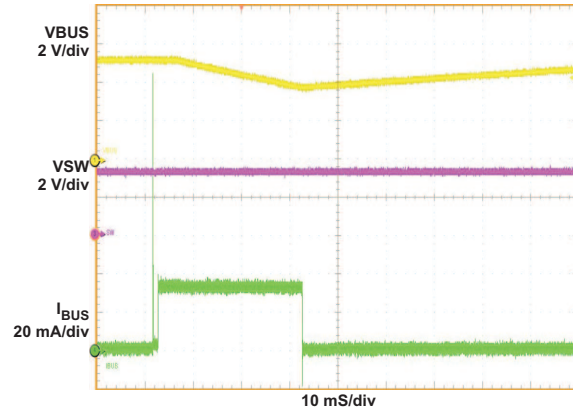

Figure 6. $V_{BUS} = 5\text{V}$ at 8 mA, $V_{BAT} = 3.2\text{V}$, $I_{in_limit} = 100\text{mA}$, $I_{CHG} = 550\text{mA}$

CHARGE CURRENT RAMP UP

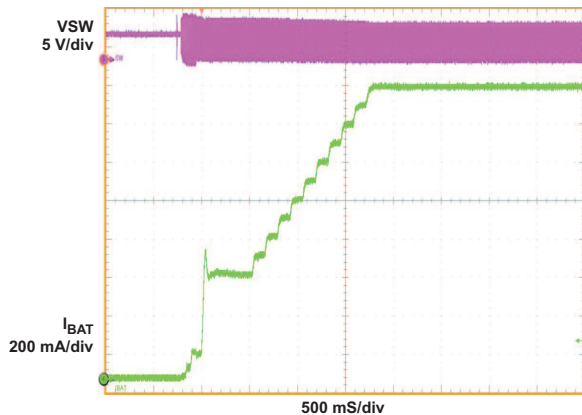

Figure 7. $V_{in} = 5\text{V}$, $V_{BAT} = 3.2\text{V}$, No Input Current Limit, $I_{CHG} = 1550\text{mA}$

INPUT CURRENT CONTROL

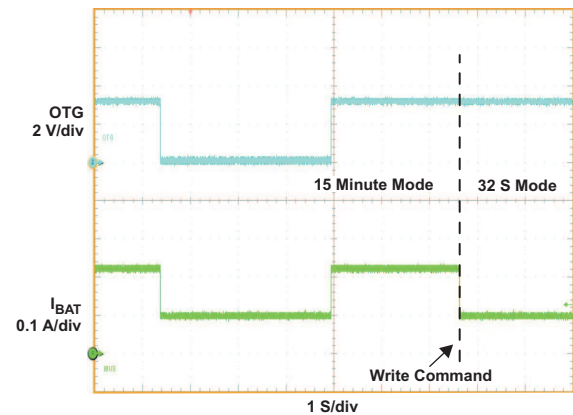

Figure 8. $V_{BUS} = 5\text{V}$, $V_{BAT} = 3.1\text{V}$, $I_{in_limit} = 100/500\text{mA}$, (OTG Control, 15 Minute Mode), $I_{in_limit} = 100\text{mA}$ ($I^2\text{C}$ Control, 32 Second Mode)

TYPICAL PERFORMANCE CHARACTERISTICS (continued)
VIN BASED DPM

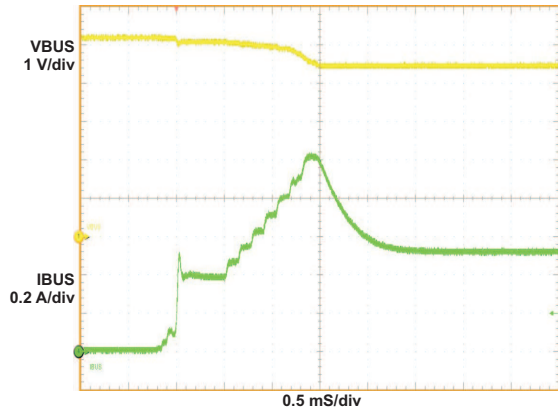

Figure 9. $V_{BUS} = 5\text{ V}$ at 500 mA , $V_{BAT} = 3.5\text{ V}$,
 $I_{CHG} = 1550\text{ mA}$,
 $V_{IN_DPM} = 4.52\text{ V}$

CHARGER EFFICIENCY

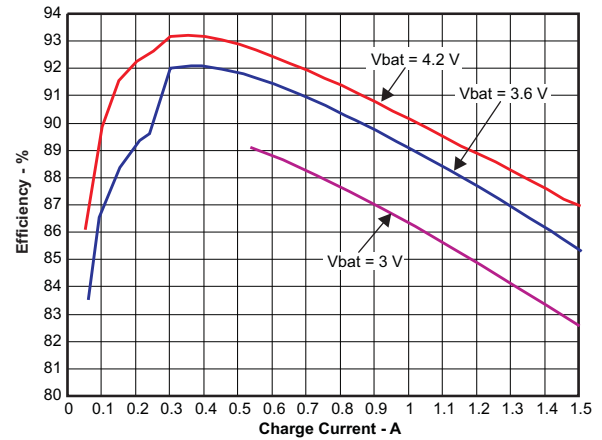

Figure 10.

BOOST WAVEFORM (PWM MODE)

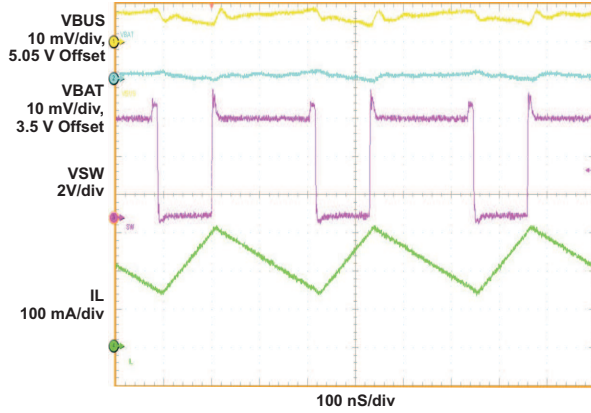

Figure 11. $V_{BUS} = 5.05\text{ V}$, $V_{BAT} = 3.5\text{ V}$, $I_{BUS} = 217\text{ mA}$

BOOST WAVEFORM (PFM MODE)

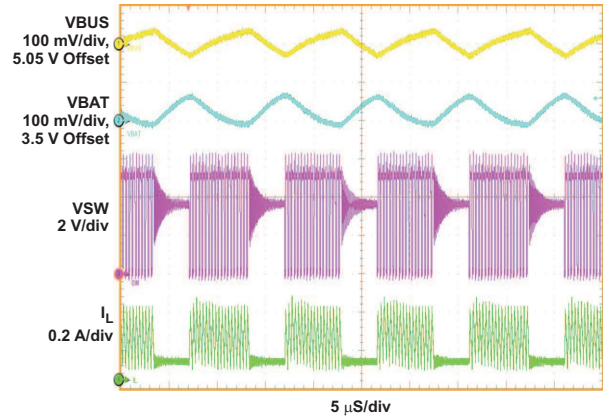

Figure 12. $V_{BUS} = 5.05\text{ V}$, $V_{BAT} = 3.5\text{ V}$, $I_{BUS} = 42\text{ mA}$

VBUS OVERLOAD WAVEFORMS (BOOST MODE)

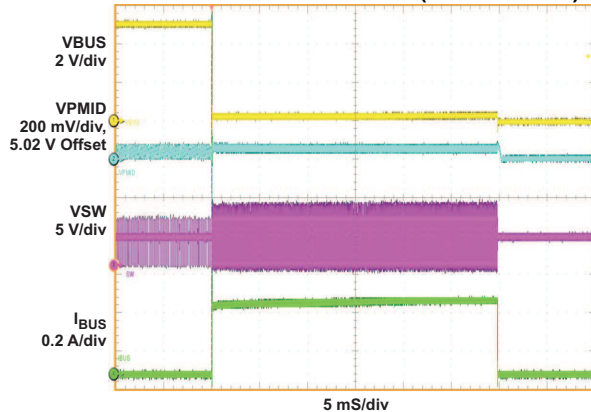

Figure 13. $V_{BUS} = 5.05\text{ V}$, $V_{BAT} = 3.5\text{ V}$, R_{LOAD} (at V_{BUS}) =
 $1\text{ k}\Omega$ to 0.5Ω

LOAD STEP UP RESPONSE (BOOST MODE)

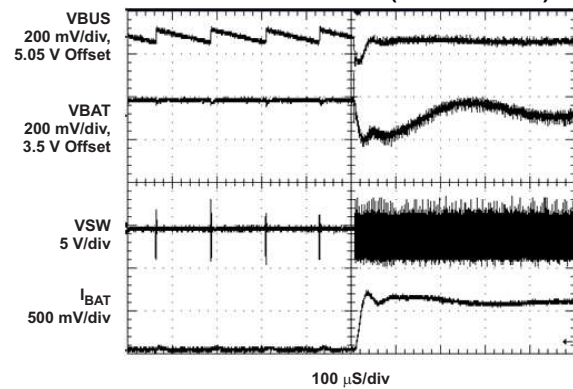

Figure 14. $V_{BUS} = 5.05$, $V_{BAT} = 3.5\text{ V}$, $I_{BUS} = 0\text{--}360\text{ mA}$

TYPICAL PERFORMANCE CHARACTERISTICS (continued)

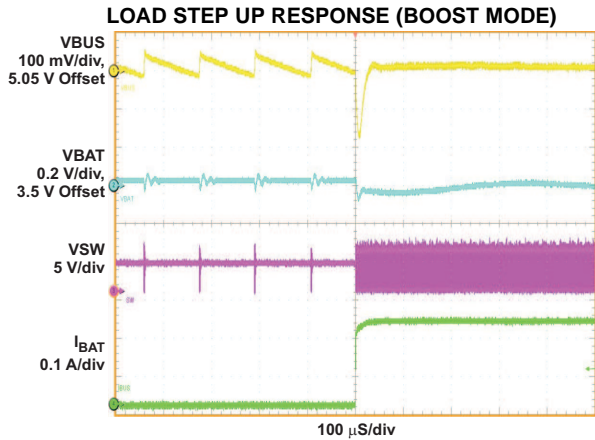

Figure 15. $V_{BUS} = 5.05\text{ V}$, $V_{BAT} = 3.5\text{ V}$, $I_{BUS} = 0\text{-}217\text{ mA}$

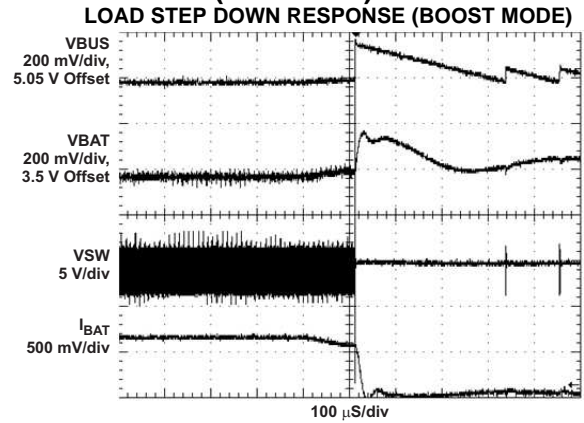

Figure 16. $V_{BUS} = 5.05$, $V_{BAT} = 3.5\text{ V}$, $I_{BUS} = 360\text{-}0\text{ mA}$

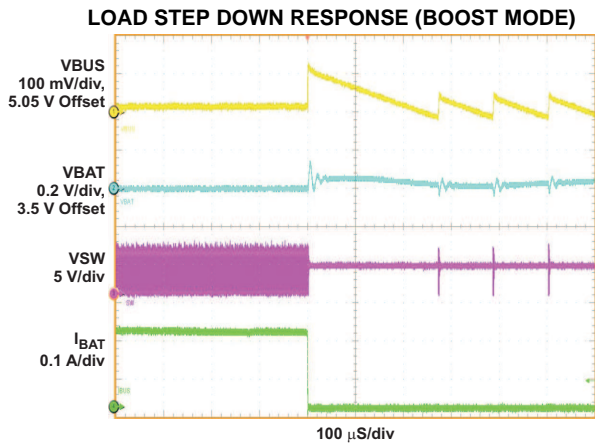

Figure 17. $V_{BUS} = 5.05\text{ V}$, $V_{BAT} = 3.5\text{ V}$, $I_{BUS} = 217\text{ mA}$

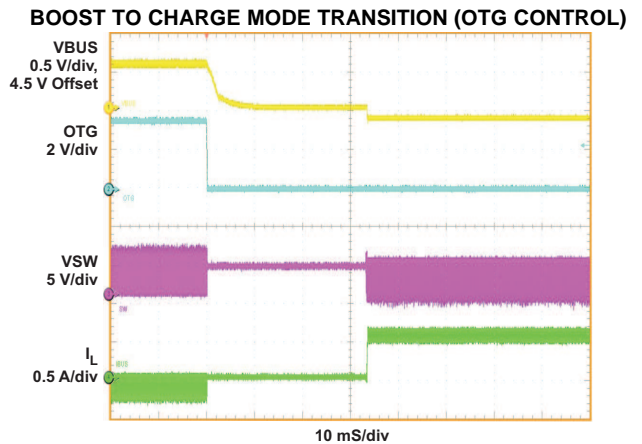

Figure 18. $V_{BUS} = 4.5\text{ V}$ (Charge Mode) / 5.1 V (Boost Mode), $V_{BAT} = 3.5\text{ V}$, $I_{IN_LIM} = 500\text{ mA}$, (32S mode)

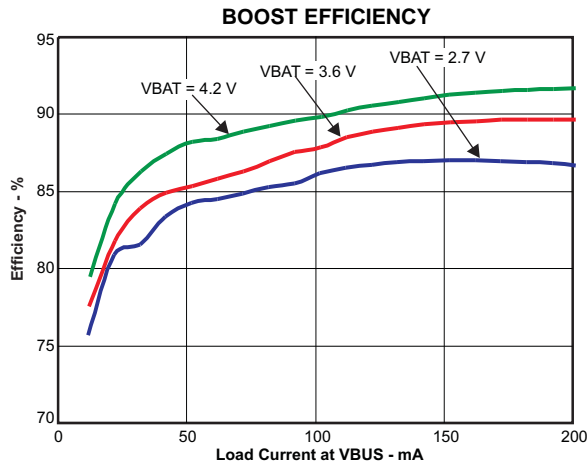

Figure 19.

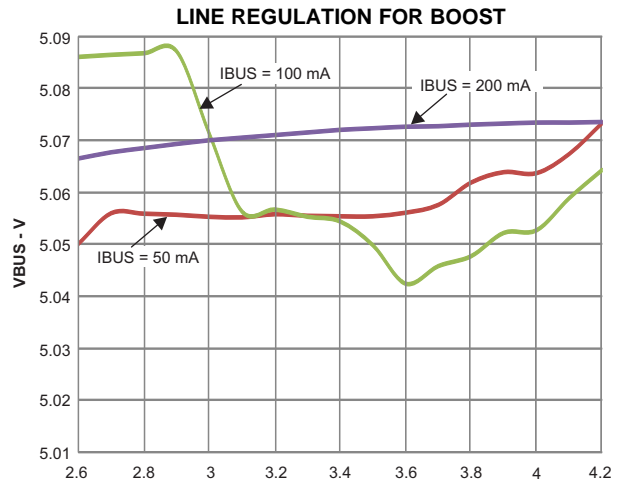

Figure 20.

TYPICAL PERFORMANCE CHARACTERISTICS (continued) LOAD REGULATION FOR BOOST

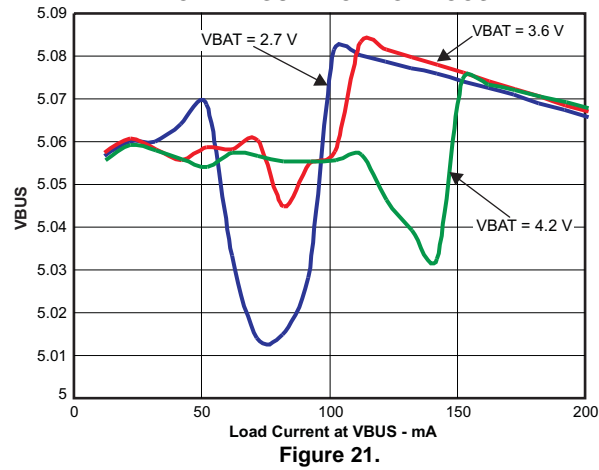

Figure 21.

FUNCTIONAL BLOCK DIAGRAM (Charge Mode)

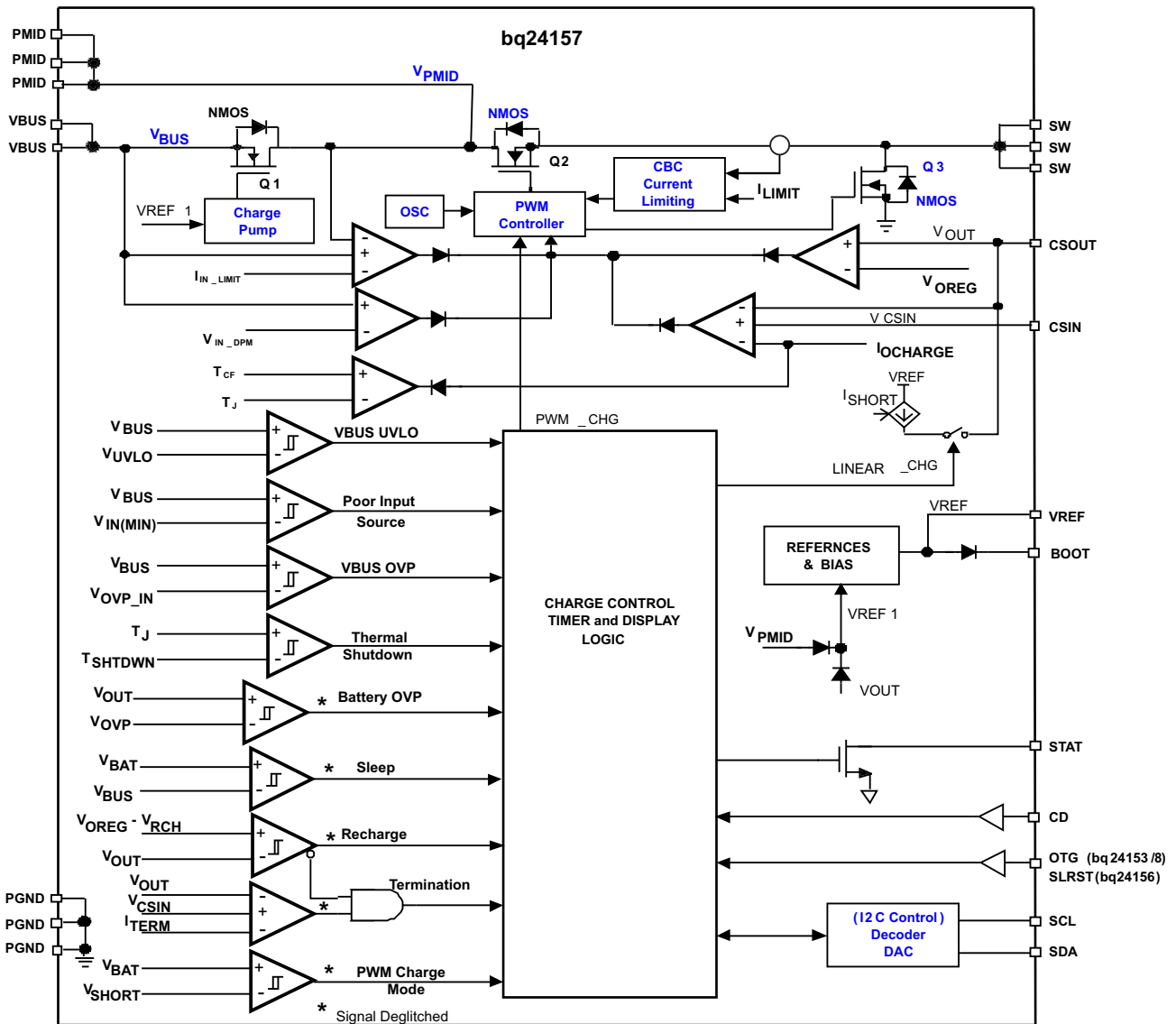

Figure 22. Function Block Diagram of bq2415x in Charge Mode

FUNCTIONAL BLOCK DIAGRAM (Boost Mode)

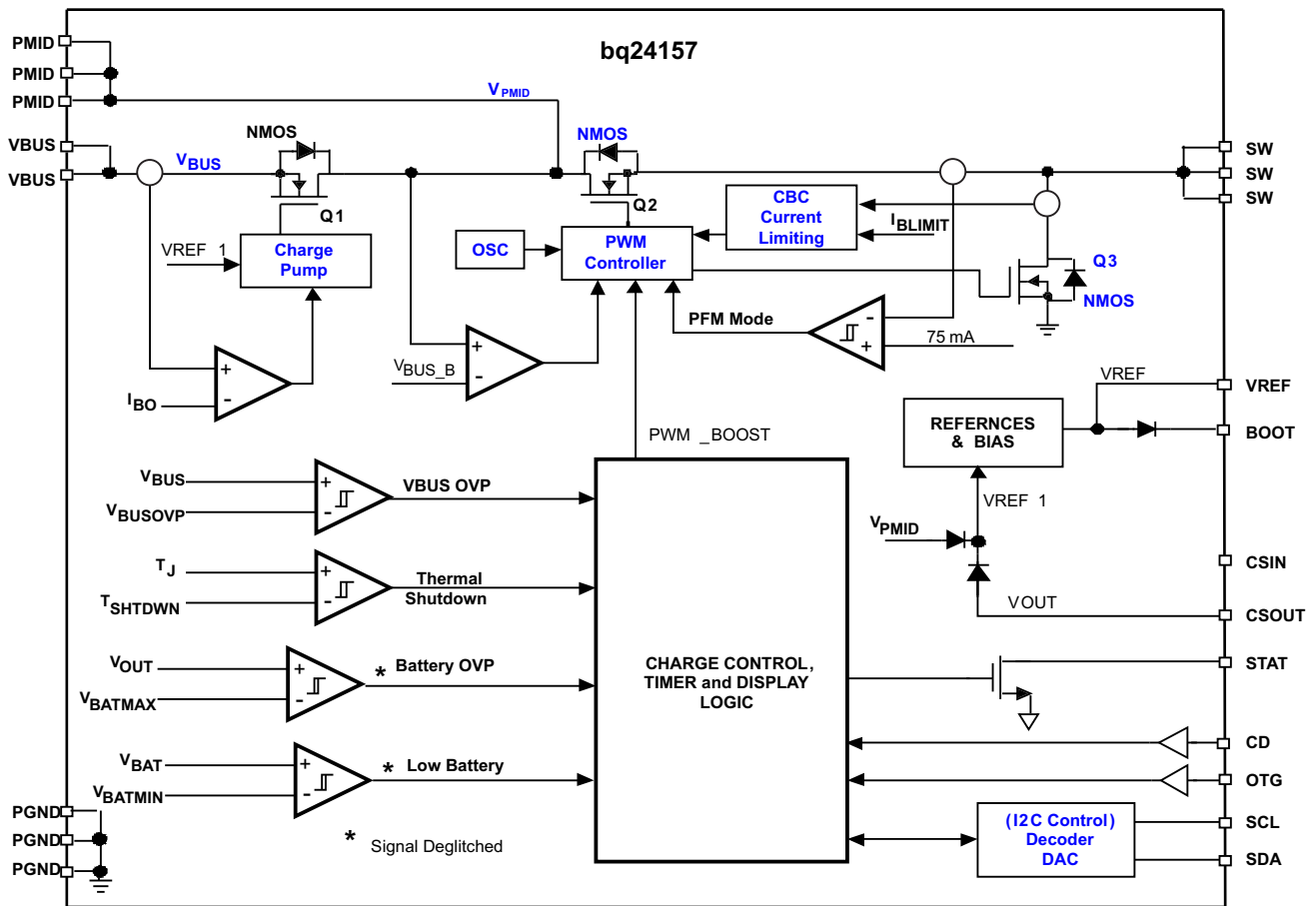

Figure 23. Function Block Diagram of bq2415x in Boost Mode

DETAILED FUNCTIONAL DESCRIPTION

For a current restricted power source, such as a USB host or hub, a high efficiency converter is critical to fully use the input power capacity for quickly charging the battery. Due to the high efficiency for a wide range of input voltages and battery voltages, the switch mode charger is a good choice for high speed charging with less power loss and better thermal management than a linear charger.

The bq24157 are highly integrated synchronous switch-mode chargers, featuring integrated FETs and small external components, targeted at extremely space-limited portable applications powered by 1-cell Li-Ion or Li-polymer battery pack. Furthermore, bq24157 also has bi-directional operation to achieve boost function for USB OTG support.

The bq24157 have three operation modes: charge mode, boost mode, and high impedance mode. In charge mode, the IC supports a precision Li-ion or Li-polymer charging system for single-cell applications. In boost mode, the IC boosts the battery voltage to VBUS for powering attached OTG devices. In high impedance mode, the IC stops charging or boosting and operates in a mode with very low current from VBUS or battery, to effectively reduce the power consumption when the portable device is in standby mode. Through I²C communication with a host, referred to as "HOST" control/mode, the IC achieves smooth transition among the different operation modes. Even when no I²C communication is available, the IC starts in default mode. During default mode operation, the charger will still charge the battery but using each register's default values.

Input Voltage Protection

Input Overvoltage Protection

The IC provides a built-in input overvoltage protection to protect the device and other components against damage if the input voltage (Voltage from VBUS to PGND) goes too high. When an input overvoltage condition is detected, the IC turns off the PWM converter, sets fault status bits, and sends out a fault pulse from the STAT pin. Once V_{BUS} drops below the input overvoltage exit threshold, the fault is cleared and charge process resumes.

Bad Adaptor Detection/Rejection

Although not shown in [Figure 24](#), at power-on-reset (POR) of VBUS, the IC performs the bad adaptor detection by applying a current sink to VBUS. If the VBUS is higher than V_{IN(MIN)} for 30ms, the adaptor is good and the charge process begins. Otherwise, if the VBUS drops below V_{IN(MIN)}, a bad adaptor is detected. Then, the IC disables the current sink, sends a send fault pulse in FAULT pin and sets the bad adaptor flag (B2 - B0 = 011 for Register 00H). After a delay of T_{INT}, the IC repeats the adaptor detection process, as shown in [Figure 25](#) and [Figure 26](#).

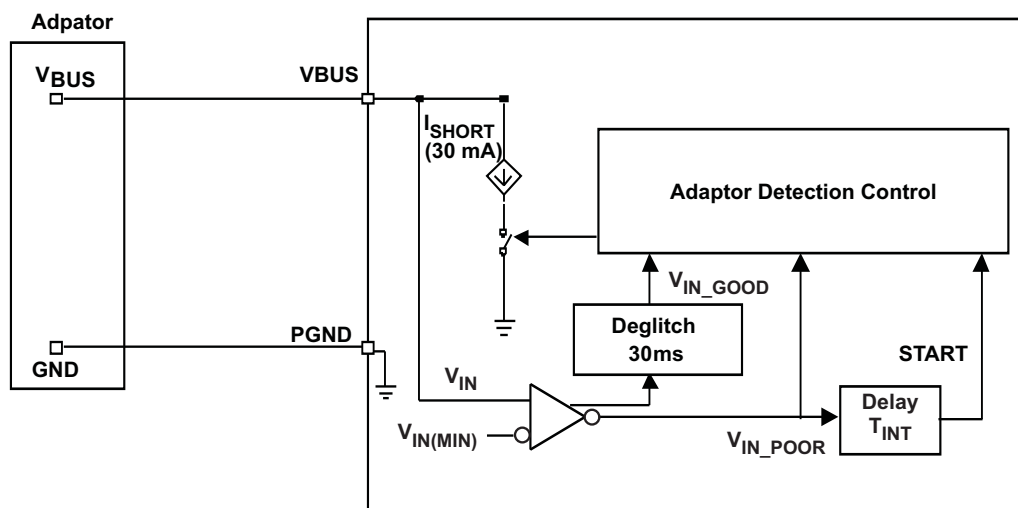

Figure 25. Bad Adaptor Detection Circuit

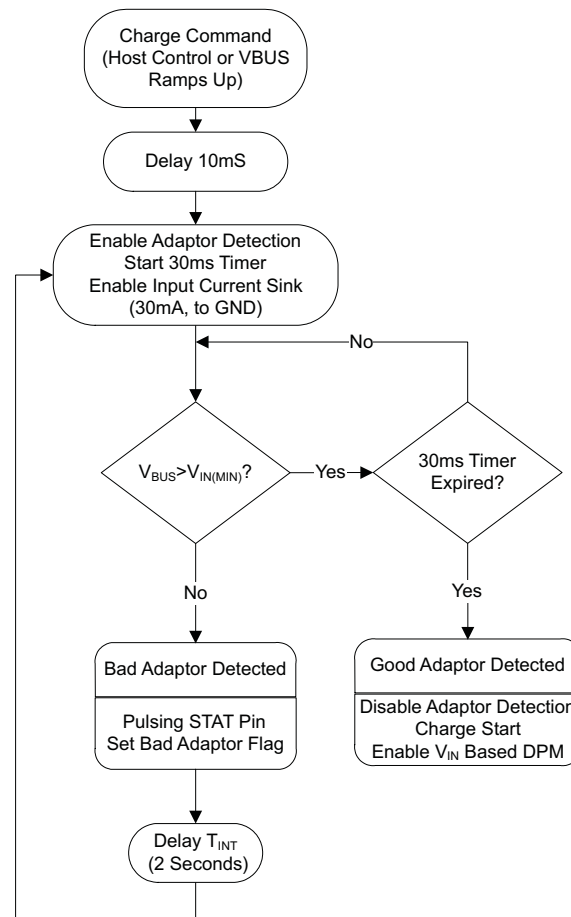

Figure 26. Bad Adaptor Detection Scheme Flow Chart

Sleep Mode

The IC enters the low-power sleep mode if the VBUS pin voltage falls below the sleep-mode entry threshold, $V_{CSOUT} + V_{SLP}$, and VBUS is higher than the bad adaptor detection threshold, $V_{IN(MIN)}$. This feature prevents draining the battery during the absence of VBUS. During sleep mode, both the reverse blocking switch Q1 and PWM are turned off.

Input Voltage Based DPM (Special Charger Voltage Threshold)

During the charging process, if the input power source is not able to support the programmed or default charging current, the VBUS voltage will decrease. Once the VBUS drops to V_{IN_DPM} (default 4.52V), the charge current begins to taper down to prevent any further drop of VBUS. When the IC enters this mode, the charge current is lower than the set value and the special charger bit is set (B4 in Register 05H). This feature makes the IC compatible with adapters having different current capabilities.

BATTERY PROTECTION

Output Overvoltage Protection

The IC provides a built-in overvoltage protection to protect the device and other components against damage if the battery voltage goes too high, as when the battery is suddenly removed. When an overvoltage condition is detected, the IC turns off the PWM converter, sets fault status bits, and sends out a fault pulse from the STAT pin. Once $V_{(CSOUT)}$ drops to the battery overvoltage exit threshold, the fault is cleared and charge process resumes.

Battery Short Protection

During the normal charging process, if the battery voltage is lower than the short-circuit threshold, V_{SHORT} , the charger operates in short circuit mode with a lower charge rate of I_{SHORT} .

Battery Detection in Host Mode

For applications with removable battery packs, the IC provides a battery absent detection scheme to reliably detect insertion or removal of battery packs.

During the normal charging process with host control, once the voltage at the CSOUT pin is above the battery recharge threshold, $V_{\text{OREG}} - V_{\text{RCH}}$, and the termination charge current is detected, the IC turns off the PWM charge and enables a discharge current, I_{DETECT} , for a period of t_{DETECT} , (262 ms typical) then checks the battery voltage. If the battery voltage is still above the recharge threshold after t_{DETECT} , the battery is present. On the other hand, if the battery voltage is below the battery recharge threshold, the battery is absent. Under this condition, the charge parameters (such as input current limit) are reset to the default values and charge resumes after a delay of T_{INT} . This function ensures that the charge parameters are reset whenever the battery is replaced.

15-MINUTE SAFETY TIMER

The bq24157 stays in 15-minute (default) mode indefinitely until I²C communication begins. When I²C communication begins, the host processor does not need to reset this 15 minutes timer while charging the battery.

USB FRIENDLY POWER UP

The default control bits set the charging current and regulation voltage low as a safety feature to avoid violating USB spec and over-charging any of the Li-Ion chemistries, while the host has lost communication. The input current limiting is described below.

INPUT CURRENT LIMITING AT POWER UP

The input current sensing circuit and control loop are integrated into the IC. When operating in default mode, the OTG pin logic level sets the input current limit to 100mA for a logic low and 500mA for a logic high. In host mode, the input current limit is set by the programmed control bits in register 01H.

CHARGE MODE OPERATION

Charge Profile

Once a good battery with voltage below the recharge threshold has been inserted and a good adapter is attached, the bq2415x enters charge mode. In charge mode, the IC has five control loops to regulate input voltage, input current, charge current, charge voltage and device junction temperature. During the charging process, all five loops are enabled and the one that is dominant takes control. The IC supports a precision Li-ion or Li-polymer charging system for single-cell applications. [Figure 27 \(a\)](#) indicates a typical charge profile without input current regulation loop. It is the traditional CC/CV charge curve, while [Figure 27\(b\)](#) shows a typical charge profile when input current limiting loop is dominant during the constant current mode. In this case, the charge current is higher than the input current so the charge process is faster than the linear chargers. The input voltage threshold for DPM loop, input current limits, charge current, termination current, and charge voltage are all programmable using I²C interface.

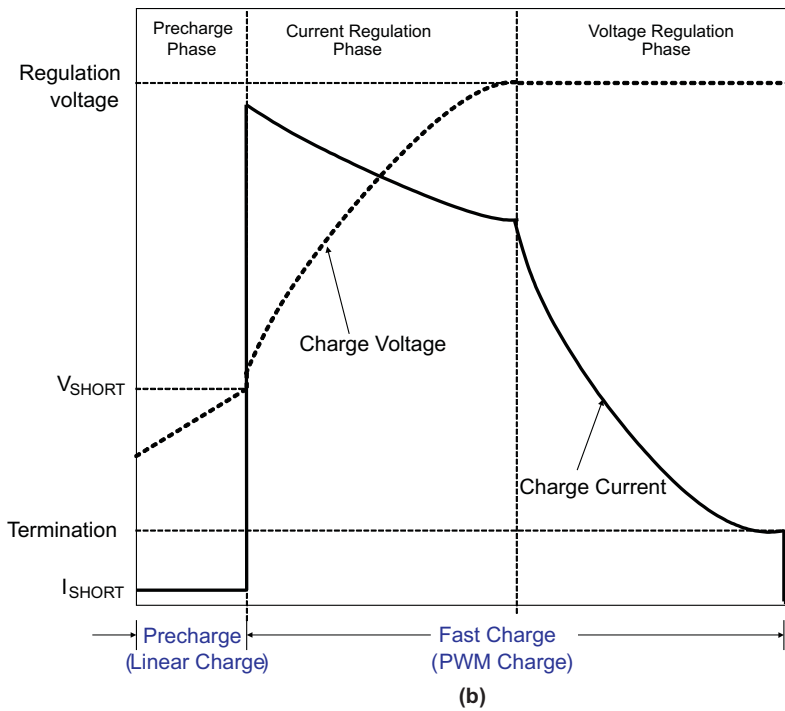
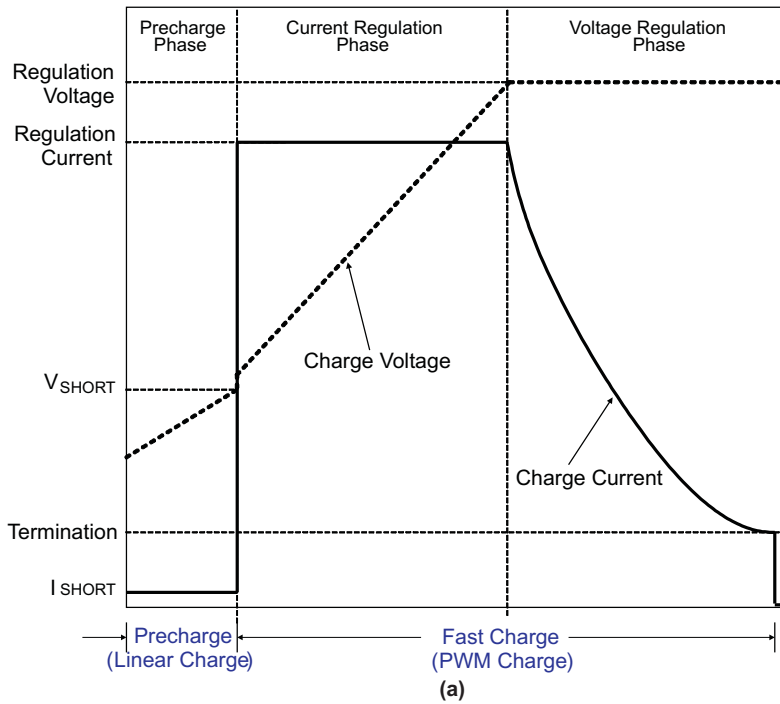

Figure 27. Typical Charging Profile for (a) without Input Current Limit, and (b) with Input Current Limit

PWM Controller in Charge Mode

The IC provides an integrated, fixed 3 MHz frequency voltage-mode controller to regulate charge current or voltage. This type of controller is used to improve line transient response, thereby, simplifying the compensation network used for both continuous and discontinuous current conduction operation. The voltage and current loops are internally compensated using a Type-III compensation scheme that provides enough phase margin for stable operation, allowing the use of small ceramic capacitors with a low ESR. The device operates between 0% to 99.5% duty cycles.

The IC has back to back common-drain N-channel FETs at the high side and one N-channel FET at low side. The input N-FET (Q1) prevents battery discharge when V_{BUS} is lower than V_{CSOUT}. The second high-side N-FET (Q2) is the switching control switch. A charge pump circuit is used to provide gate drive for Q1, while a bootstrap circuit with an external bootstrap capacitor is used to supply the gate drive voltage for Q2.

Cycle-by-cycle current limit is sensed through the FETs Q2 and Q3. The threshold for Q2 is set to a nominal 2.4-A peak current. The low-side FET (Q3) also has a current limit that decides if the PWM Controller will operate in synchronous or non-synchronous mode. This threshold is set to 100mA and it turns off the low-side N-channel FET (Q3) before the current reverses, preventing the battery from discharging. Synchronous operation is used when the current of the low-side FET is greater than 100mA to minimize power losses.

Battery Charging Process

At the beginning of precharge, while battery voltage is below the V_(SHORT) threshold, the IC applies a short-circuit current, I_(SHORT), to the battery. When the battery voltage is above V_{SHORT} and below V_{OREG}, the charge current ramps up to fast charge current, I_{CHARGE}, or a charge current that corresponds to the input current of I_{IN_LIMIT}. The slew rate for fast charge current is controlled to minimize the current and voltage over-shoot during transient. Both the input current limit, I_{IN_LIMIT}, and fast charge current, I_{CHARGE}, can be set by the host. Once the battery voltage reaches the regulation voltage, V_{OREG}, the charge current is tapered down as shown in [Figure 27](#). The voltage regulation feedback occurs by monitoring the battery-pack voltage between the CSOUT and PGND pins. In HOST mode, the regulation voltage is adjustable (3.5V to 4.44V) and is programmed through I²C interface. In 15-minute mode, the regulation voltage is fixed at 3.54V.

The IC monitors the charging current during the voltage regulation phase. If termination is enabled, during the normal charging process with HOST control, once the voltage at the CSOUT pin is above the battery recharge threshold, V_{OREG} - V_{RCH} for the 32-ms (typical) deglitch period, and the termination charge current I_{TERM} is detected, the IC turns off the PWM charge and enables a discharge current, I_{DETECT}, for a period of t_{DETECT} (262-ms typical), then checks the battery voltage. If the battery voltage is still above the recharge threshold after t_{DETECT}, the battery charging is complete. The battery detection routine is used to ensure termination did not occur because the battery was removed. After 40ms (typical) for synchronization purposes of the EOC state and the counter, the status bit and pin are updated to indicate charging has completed. The termination current level is programmable. To disable the charge current termination, the host can set the charge termination bit (I_{Term}) of charge control register to 0, refer to I²C section for detail.

A new charge cycle is initiated when one of the following conditions is detected:

- The battery voltage falls below the V_(OREG) - V_(RCH) threshold.
- V_{BUS} Power-on reset (POR), if battery voltage is below the V_(LOWV) threshold.
- \overline{CE} bit toggle or RESET bit is set (Host controlled)

Thermal Regulation and Protection

To prevent overheating of the chip during the charging process, the IC monitors the junction temperature, T_J, of the die and begins to taper down the charge current once T_J reaches the thermal regulation threshold, T_{CF}. The charge current is reduced to zero when the junction temperature increases approximately 10°C above T_{CF}. In any state, if T_J exceeds T_{SHTDWN}, the IC suspends charging. In thermal shutdown mode, PWM is turned off and all timers are frozen. Charging resumes when T_J falls below T_{SHTDWN} by approximately 10°C.

Charge Status Output, STAT Pin

The STAT pin is used to indicate operation conditions. STAT is pulled low during charging when EN_STAT bit in control register (00H) is set to “1”. Under other conditions, STAT pin behaves as a high impedance (open-drain) output. Under fault conditions, a 128-μs pulse will be sent out to notify the host. The status of STAT pin at different operation conditions is summarized in [Table 1](#). The STAT pin can be used to drive an LED or communicate to the host processor.

Table 1. STAT Pin Summary

CHARGE STATE	STAT
Charge in progress and EN_STAT=1	Low
Other normal conditions	Open-drain
Charge mode faults: Timer fault, sleep mode, VBUS or battery overvoltage, poor input source, VBUS UVLO, no battery, thermal shutdown	128- μ s pulse, then open-drain
Boost mode faults: Timer fault, over load, VBUS or battery overvoltage, low battery voltage, thermal shutdown	128- μ s pulse, then open-drain

Control Bits in Charge Mode

\overline{CE} Bit (Charge Mode)

The \overline{CE} bit in the control register is used to disable or enable the charge process. A low logic level (0) on this bit enables the charge and a high logic level (1) disables the charge.

RESET Bit

The RESET bit in the control register is used to reset all the charge parameters. Writing '1' to the RESET bit will reset all the charge parameters to default values except the safety limit register, and RESET bit is automatically cleared to zero once the charge parameters get reset. It is designed for charge parameter reset before charge starts and it is not recommended to set the RESET bit while charging or boosting are in progress.

OPA_Mode Bit

OPA_MODE is the operation mode control bit. When OPA_MODE = 0, the IC operates as a charger if HZ_MODE is set to "0", refer to [Table 2](#) for detail. When OPA_MODE=1 and HZ_MODE=0, the IC operates in boost mode.

Table 2. Operation Mode Summary

OPA_MODE	HZ_MODE	OPERATION MODE
0	0	Charge (no fault) Charge configure (fault, $V_{BUS} > UVLO$) High impedance ($V_{BUS} < UVLO$)
1	0	Boost (no faults) Any fault go to charge configure mode
X	1	High impedance

CONTROL PINS IN CHARGE MODE

CD Pin (Charge Disable)

The CD pin is used to disable the charging process. When the CD pin is low, charge is enabled. When the CD pin is high, charge is disabled and the charger enters high impedance (Hi-Z) mode.

BOOST MODE OPERATION

In host mode, when OTG pin is high (and OTG_EN bit is high thereby enabling OTG functionality) or the operation mode bit (OPA_MODE) is set to 1, the device operates in boost mode and delivers the power to VBUS from the battery. In normal boost mode converts the battery voltage to V_{BUS-B} (about 5.05V) and delivers a current as much as I_{BO} (about 200mA) to support other USB OTG devices connected to the USB connector.

PWM Controller in Boost Mode

Similar to charge mode operation, in boost mode, the IC provides an integrated, fixed 3 MHz frequency voltage-mode controller to regulate output voltage at PMID pin (V_{PMID}). The voltage control loop is internally compensated using a Type-III compensation scheme that provides enough phase margin for stable operation with a wide load range and battery voltage range.

In boost mode, the input N-FET (Q1) prevents battery discharge when VBUS pin is over loaded. Cycle-by-cycle current limit is sensed through the internal sense FET for Q3. The cycle-by-cycle current limit threshold for Q3 is set to a nominal 1.0-A peak current. Synchronous operation is used in PWM mode to minimize power losses.

Boost Start Up

To prevent the inductor saturation and limit the inrush current, a soft-start control is applied during the boost start up.

PFM Mode at Light Load

In boost mode, under light load conditions, the IC operates in pulse skipping mode (PFM mode) to reduce the power loss and improve the converter efficiency. During boosting, the PWM converter is turned off once the inductor current is less than 75mA; and the PWM is turned back on only when the voltage at PMID pin drops to about 99.5% of the rated output voltage. A unique pre-set circuit is used to make the smooth transition between PWM and PFM mode.

Protection in Boost Mode

Output Overvoltage Protection

The IC provides a built-in over-voltage protection to protect the device and other components against damage if the VBUS voltage goes too high. When an over-voltage condition is detected, the IC turns off the PWM converter, resets OPA_MODE bit to 0, sets fault status bits, and sends out a fault pulse from the STAT pin. Once VBUS drops to the normal level, the boost starts after host sets OPA_MODE to “1” or OTG pin stays in active status.

Output Overload Protection

The IC provides a built-in over-load protection to prevent the device and battery from damage when VBUS is over loaded. Once the over load condition is detected, Q1 operates in linear mode to limit the output current. If the over load condition lasts for more than 30ms, the over-load fault is detected. When an over-load condition is detected, the IC turns off the PWM converter, resets OPA_MODE bit to 0, sets fault status bits and sends out fault pulse in STAT pin. The boost will not start until the host clears the fault register.

Battery Overvoltage Protection

During boosting, when the battery voltage is above the battery over voltage threshold, V_{BATMAX} , or below the minimum battery voltage threshold, V_{BATMIN} , the IC turns off the PWM converter, resets OPA_MODE bit to 0, sets fault status bits and sends out fault pulse in STAT pin. Once the battery voltage goes above V_{BATMIN} , the boost will start after the host sets OPA_MODE to “1” or OTG pin stays in active status.

STAT Pin in Boost Mode

During normal boosting operation, the STAT pin behaves as a high impedance (open-drain) output. Under fault conditions, a 128- μ s pulse is sent out to notify the host.

HIGH IMPEDANCE (Hi-Z) MODE

In Hi-Z mode, the charger stops charging and enters a low quiescent current state to conserve power. Taking the CD pin high causes the charger to enter Hi-Z mode. When in default mode and the CD pin is low, the charger automatically enters Hi-Z mode if

1. VBUS > UVLO and a battery with $V_{BAT} > V_{LOWV}$ is inserted, or
2. VBUS falls below UVLO.

When in HOST mode and the CD is low, the charger can be placed into Hi-Z mode if the HZ-MODE control bit is set to “1” and OTG pin is not in active status.

In order to exit Hi-Z mode, the CD pin must be low, VBUS must be higher than UVLO and the HOST must write a “0” to the HZ-MODE control bit.

SERIAL INTERFACE DESCRIPTION

I²C is a 2-wire serial interface developed by Philips Semiconductor (see I²C-Bus Specification, Version 2.1, January 2000). The bus consists of a data line (SDA) and a clock line (SCL) with pull-up structures. When the bus is idle, both SDA and SCL lines are pulled high. All the I²C compatible devices connect to the I²C bus through open drain I/O pins, SDA and SCL. A master device, usually a microcontroller or a digital signal processor, controls the bus. The master is responsible for generating the SCL signal and device addresses. The master also generates specific conditions that indicate the START and STOP of data transfer. A slave device receives and/or transmits data on the bus under control of the master device.

The IC works as a slave and is compatible with the following data transfer modes, as defined in the I²C-Bus Specification: standard mode (100 kbps), fast mode (400 kbps), and high-speed mode (up to 3.4 Mbps in write mode). The interface adds flexibility to the battery charge solution, enabling most functions to be programmed to new values depending on the instantaneous application requirements. Register contents remain intact as long as supply voltage remains above 2.2 V (typical). I²C is asynchronous, which means that it runs off of SCL. The device has no noise or glitch filtering on SCL, so SCL input needs to be clean. Therefore, it is recommended that SDA changes while SCL is LOW.

The data transfer protocol for standard and fast modes is the same; therefore, they are referred to as F/S-mode in this document. The protocol for high-speed mode is different from the F/S-mode, and it is referred to as HS-mode. The bq24157B device supports 7-bit addressing only. The device 7-bit address is defined as '1101010' (6AH).

F/S Mode Protocol

The master initiates data transfer by generating a start condition. The start condition is when a high-to-low transition occurs on the SDA line while SCL is high, as shown in Figure 28. All I²C-compatible devices should recognize a start condition.

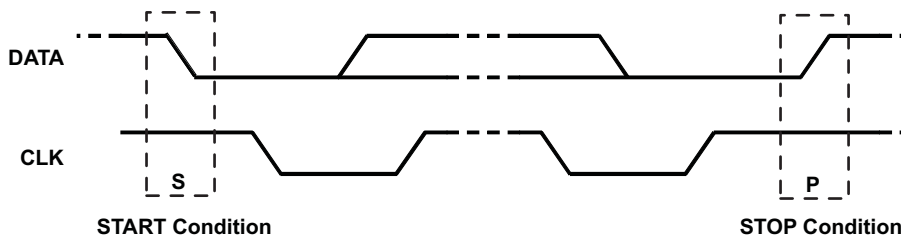

Figure 28. START and STOP Condition

The master then generates the SCL pulses, and transmits the 8-bit address and the read/write direction bit R/W on the SDA line. During all transmissions, the master ensures that data is valid. A valid data condition requires the SDA line to be stable during the entire high period of the clock pulse (see Figure 29). All devices recognize the address sent by the master and compare it to their internal fixed addresses. Only the slave device with a matching address generates an acknowledge (see Figure 29) by pulling the SDA line low during the entire high period of the ninth SCL cycle. Upon detecting this acknowledge, the master knows that communication link with a slave has been established.

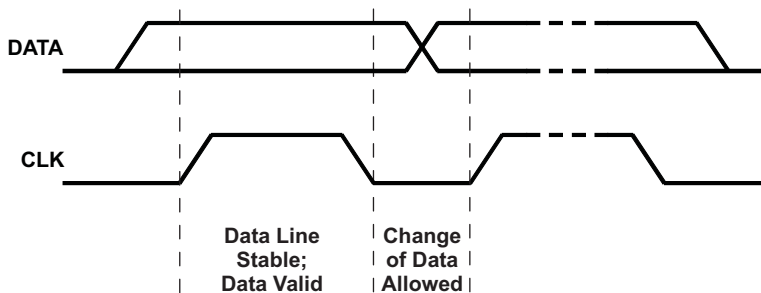

Figure 29. Bit Transfer on the Serial Interface

The master generates further SCL cycles to either transmit data to the slave (R/W bit 1) or receive data from the slave (R/W bit 0). In either case, the receiver needs to acknowledge the data sent by the transmitter. So an acknowledge signal can either be generated by the master or by the slave, depending on which one is the receiver. The 9-bit valid data sequences consisting of 8-bit data and 1-bit acknowledge can continue as long as necessary. To signal the end of the data transfer, the master generates a stop condition by pulling the SDA line from low to high while the SCL line is high (see Figure 31). This releases the bus and stops the communication link with the addressed slave. All I²C compatible devices must recognize the stop condition. Upon the receipt of a stop condition, all devices know that the bus is released, and they wait for a start condition followed by a matching address. If a transaction is terminated prematurely, the master needs to send a STOP condition to prevent the slave I²C logic from getting stuck in a bad state. Attempting to read data from register addresses not listed in this section will result in FFh being read out.

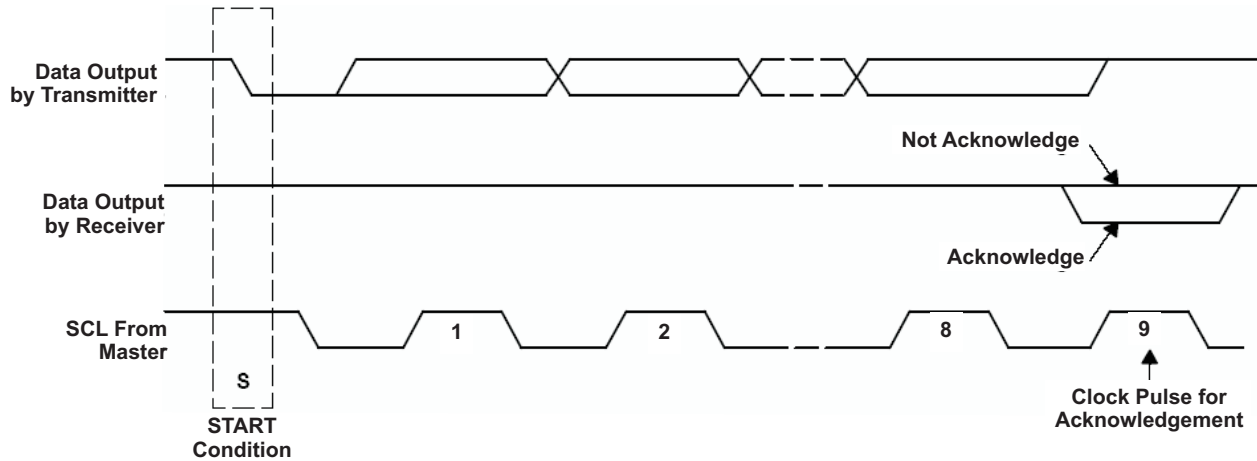

Figure 30. Acknowledge on the I²C Bus™

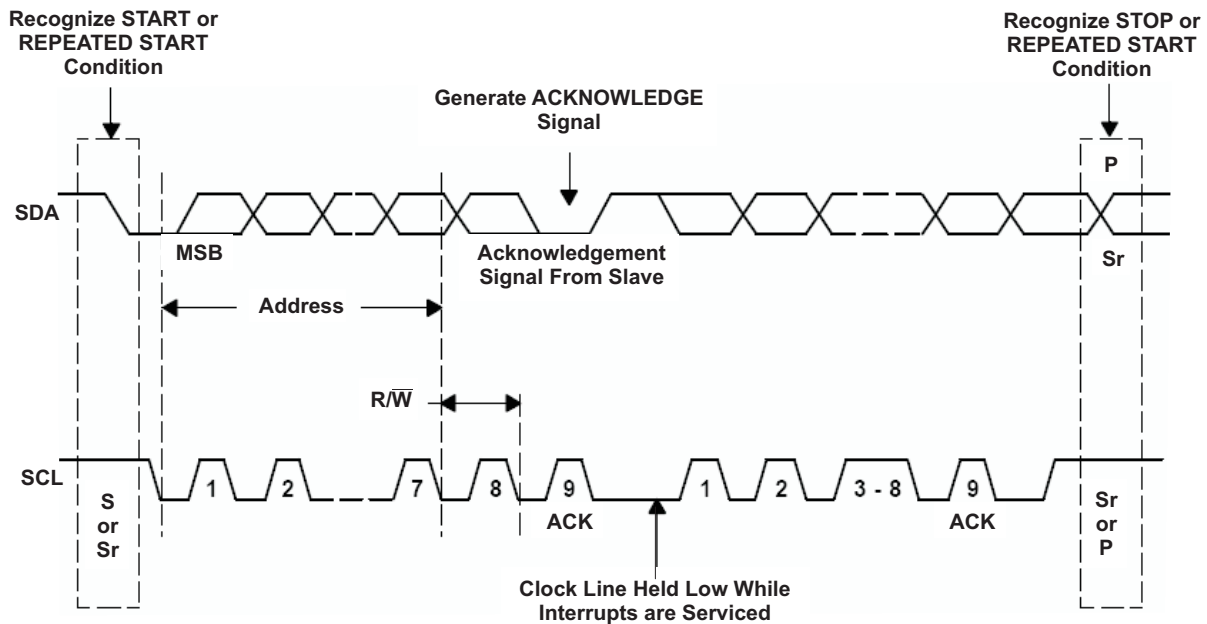

Figure 31. Bus Protocol

H/S Mode Protocol

When the bus is idle, both SDA and SCL lines are pulled high by the pull-up devices.

The master generates a start condition followed by a valid serial byte containing HS master code 00001XXX. This transmission is made in F/S-mode at no more than 400 Kbps. No device is allowed to acknowledge the HS master code, but all devices must recognize it and switch their internal setting to support 3.4-Mbps operation.

The master then generates a repeated start condition (a repeated start condition has the same timing as the start condition). After this repeated start condition, the protocol is the same as F/S-mode, except that transmission speeds up to 3.4 Mbps are allowed. A stop condition ends the HS-mode and switches all the internal settings of the slave devices to support the F/S-mode. Instead of using a stop condition, repeated start conditions should be used to secure the bus in HS-mode. If a transaction is terminated prematurely, the master needs sending a STOP condition to prevent the slave I2C logic from getting stuck in a bad state.

Attempting to read data from register addresses not listed in this section results in FFh being read out.

I²C Update Sequence

The IC requires a start condition, a valid I²C address, a register address byte, and a data byte for a single update. After the receipt of each byte, the IC acknowledges by pulling the SDA line low during the high period of a single clock pulse. A valid I²C address selects the IC. The IC performs an update on the falling edge of the acknowledge signal that follows the LSB byte.

For the first update, the IC requires a start condition, a valid I²C address, a register address byte, a data byte. For all consecutive updates, The IC needs a register address byte, and a data byte. Once a stop condition is received, the IC releases the I²C bus, and awaits a new start conditions.

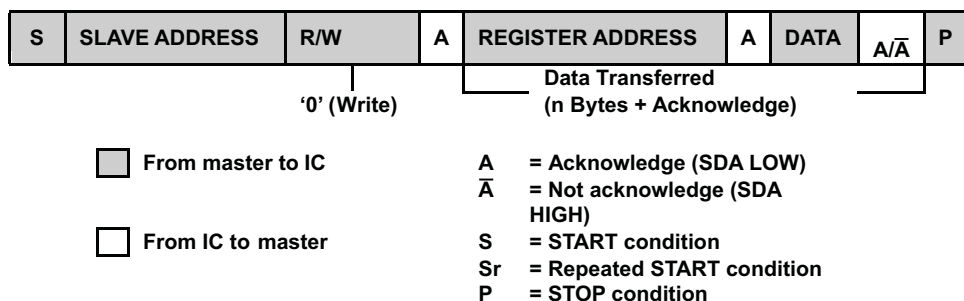

(a) F/S-Mode

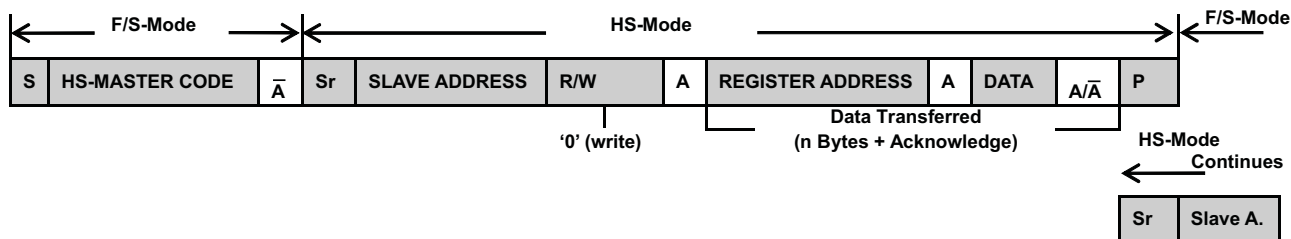

(b) HS-Mode

Figure 32. Data Transfer Format in F/S Mode and H/S Mode

Slave Address Byte

MSB								LSB
X	1	1	0	1	0	1	1	

The slave address byte is the first byte received following the START condition from the master device.

Register Address Byte

MSB					LSB		
0	0	0	0	0	D2	D1	D0

Following the successful acknowledgment of the slave address, the bus master will send a byte to the IC, which contains the address of the register to be accessed. The IC contains five 8-bit registers accessible via a bidirectional I²C-bus interface. Among them, four internal registers have read and write access; and one has only read access.

REGISTER DESCRIPTION

Table 3. Status/Control Register (Read/Write)
Memory Location: 00, Reset State: x1xx 0xxx

BIT	NAME	READ/WRITE	FUNCTION
B7 (MSB)	TMR_RST/OTG	Read/Write	Write: TMR_RST function, write "1" to reset the safety timer (auto clear) Read: OTG pin status, 0-OTG pin at Low level, 1-OTG pin at High level
B6	EN_STAT	Read/Write	0-Disable STAT pin function, 1-Enable STAT pin function (default 1)
B5	STAT2	Read Only	00-Ready, 01-Charge in progress, 10-Charge done, 11-Fault
B4	STAT1	Read Only	
B3	BOOST	Read Only	1-Boost mode, 0-Not in boost mode
B2	FAULT_3	Read Only	Charge mode: 000-Normal, 001-VBUS OVP, 010-Sleep mode, 011-Bad Adaptor or $V_{BUS} < V_{UVLO}$, 100-Output OVP, 101-Thermal shutdown, 110-Timer fault, 111-No battery Boost mode: 000-Normal, 001-VBUS OVP, 010-Over load, 011-Battery voltage is too low, 100-Battery OVP, 101-Thermal shutdown, 110-Timer fault, 111-NA
B1	FAULT_2	Read Only	
B0 (LSB)	FAULT_1	Read Only	

Table 4. Control Register (Read/Write)
Memory Location: 01, Reset State: 0011 0000

BIT	NAME	READ/WRITE	FUNCTION
B7 (MSB)	lin_Limit_2	Read/Write	00-USB host with 100-mA current limit, 01-USB host with 500-mA current limit, 10-USB host/charger with 800-mA current limit, 11-No input current limit
B6	lin_Limit_1	Read/Write	
B5	$V_{(LOWV_2)}$ ⁽¹⁾	Read/Write	Weak battery voltage threshold: 200mV step (default 1)
B4	$V_{(LOWV_1)}$ ⁽¹⁾	Read/Write	Weak battery voltage threshold: 100mV step (default 1)
B3	TE	Read/Write	1-Enable charge current termination, 0-Disable charge current termination (default 0)
B2	CE	Read/Write	1-Charger is disabled, 0-Charger enabled (default 0)
B1	HZ_MODE	Read/Write	1-High impedance mode, 0-Not high impedance mode (default 0)
B0 (LSB)	OPA_MODE	Read/Write	1-Boost mode, 0-Charger mode (default 0)

(1) The range of the weak battery voltage threshold ($V_{(LOWV)}$) is 3.4 V to 3.7 V with an offset of 3.4 V and steps of 100 mV (default 3.7 V, using bits B4-B5).

Table 5. Control/Battery Voltage Register (Read/Write)
Memory Location: 02, Reset State: 0000 1010

BIT	NAME	READ/WRITE	FUNCTION
B7 (MSB)	$V_{O(REG5)}$	Read/Write	Battery Regulation Voltage: 640 mV step (default 0)
B6	$V_{O(REG4)}$	Read/Write	Battery Regulation Voltage: 320 mV step (default 0)
B5	$V_{O(REG3)}$	Read/Write	Battery Regulation Voltage: 160 mV step (default 0)
B4	$V_{O(REG2)}$	Read/Write	Battery Regulation Voltage: 80 mV step (default 0)
B3	$V_{O(REG1)}$	Read/Write	Battery Regulation Voltage: 40 mV step (default 1)
B2	$V_{O(REG0)}$	Read/Write	Battery Regulation Voltage: 20 mV step (default 0)

Table 5. Control/Battery Voltage Register (Read/Write)
Memory Location: 02, Reset State: 0000 1010 (continued)

BIT	NAME	READ/WRITE	FUNCTION
B1	OTG_PL	Read/Write	1-OTG Boost Enable with High level, 0-OTG Boost Enable with Low level (default 1); not applicable to OTG pin control of current limit at POR in default mode
B0 (LSB)	OTG_EN	Read/Write	1-Enable OTG Pin in HOST mode, 0-Disable OTG pin in HOST mode (default 0), not applicable to OTG pin control of current limit at POR in default mode

- Charge voltage range is 3.5 V to 4.44 V with the offset of 3.5 V and steps of 20 mV (default 3.54 V), using bits B2-B7.

Table 6. Vender/Part/Revision Register (Read only)
Memory Location: 03, Reset State: 0101 000x

BIT	NAME	READ/WRITE	FUNCTION
B7 (MSB)	Vender2	Read Only	Vender Code: bit 2 (default 0)
B6	Vender1	Read Only	Vender Code: bit 1 (default 1)
B5	Vender0	Read Only	Vender Code: bit 0 (default 0)
B4	PN1	Read Only	For I2C Address 6AH: 01–NA, 10–bq24157, 11–NA.
B3	PN0	Read Only	
B2	Revision2	Read Only	011: Revision 1.0; 001: Revision 1.1; 100-111: Future Revisions
B1	Revision1	Read Only	
B0 (LSB)	Revision0	Read Only	

Table 7. Battery Termination/Fast Charge Current Register (Read/Write)
Memory Location: 04, Reset State: 0000 0001

BIT	NAME	READ/WRITE	FUNCTION
B7 (MSB)	Reset	Read/Write	Write: 1-Charger in reset mode, 0-No effect, Read: always get "0"
B6	$V_{I(CHRG3)}$ ⁽¹⁾	Read/Write	Charge current sense voltage: 27.2 mV step
B5	$V_{I(CHRG2)}$ ⁽¹⁾	Read/Write	Charge current sense voltage: 13.6 mV step
B4	$V_{I(CHRG1)}$ ⁽¹⁾	Read/Write	Charge current sense voltage: 6.8 mV step
B3	$V_{I(CHRG0)}$ ⁽¹⁾	Read/Write	NA
B2	$V_{I(TERM2)}$ ⁽²⁾	Read/Write	Termination current sense voltage: 13.6 mV step (default 0)
B1	$V_{I(TERM1)}$ ⁽²⁾	Read/Write	Termination current sense voltage: 6.8 mV step (default 0)
B0 (LSB)	$V_{I(TERM0)}$ ⁽²⁾	Read/Write	Termination current sense voltage: 3.4 mV step (default 1)

(1) See [Table 11](#)

(2) See [Table 10](#)

- Charge current sense voltage offset is 37.4mV and default charge current is 550mA, if 68-mΩ sensing resistor is used and LOW_CHG=0.

Table 8. Special Charger Voltage/Enable Pin Status Register
Memory location: 05, Reset state: 000X X100

BIT	NAME	READ/WRITE	FUNCTION
B7 (MSB)	NA	Read/Write	NA
B6	NA	Read/Write	NA
B5	LOW_CHG	Read/Write	0 – Normal charge current sense voltage at 04H, 1 – Low charge current sense voltage of 22.1mV (default 0)
B4	DPM_STATUS	Read Only	0 – DPM mode is not active, 1 – DPM mode is active
B3	CD_STATUS	Read Only	0 – CD pin at LOW level, 1 – CD pin at HIGH level
B2	VSREG2	Read/Write	Special charger voltage: 320mV step (default 1)
B1	VSREG1	Read/Write	Special charger voltage: 160mV step (default 0)
B0 (LSB)	VSREG0	Read/Write	Special charger voltage: 80mV step (default 0)

- Special charger voltage offset is 4.2V and default special charger voltage is 4.52V.
- Default charge current will be 550mA, if 68-mΩ sensing resistor is used, since default LOW_CHG=0.

**Table 9. Safety Limit Register (READ/WRITE, Write only once after reset!)
Memory location: 06, Reset state: 01000000**

BIT	NAME	READ/WRITE	FUNCTION
B7 (MSB)	V _{MCHRG3} ⁽¹⁾	Read/Write	Maximum charge current sense voltage: 54.4 mV step (default 0) ⁽²⁾
B6	V _{MCHRG2} ⁽¹⁾	Read/Write	Maximum charge current sense voltage: 27.2 mV step (default 1)
B5	V _{MCHRG1} ⁽¹⁾	Read/Write	Maximum charge current sense voltage: 13.6 mV step (default 0)
B4	V _{MCHRG0} ⁽¹⁾	Read/Write	Maximum charge current sense voltage: 6.8 mV step (default 0)
B3	V _{MREG3}	Read/Write	Maximum battery regulation voltage: 160 mV step (default 0)
B2	V _{MREG2}	Read/Write	Maximum battery regulation voltage: 80 mV step (default 0)
B1	V _{MREG1}	Read/Write	Maximum battery regulation voltage: 40 mV step (default 0)
B0 (LSB)	V _{MREG0}	Read/Write	Maximum battery regulation voltage: 20 mV step (default 0)

(1) Refer to [Table 11](#)

- Maximum charge current sense voltage offset is 37.4 mV (550mA), default at 64.6mV (950mA) and the maximum charge current option is 1.55A (105.4mV), if 68-mΩ sensing resistor is used.
- Maximum battery regulation voltage offset is 4.2V (default at 4.2V) and maximum battery regulation voltage option is 4.44V.
- Memory location 06H resets only when V_(CSOUT) drops below V_(SHORT) threshold (typ. 2.05V). After reset, the maximum values for battery regulation voltage and charge current can be programmed until any writing to other register locks the safety limits. Programmed values exclude higher values from memory locations 02 (battery regulation voltage), and from memory location 04 (Fast charge current).
- If host accesses (write command) to some other register before Safety limit register, the safety default values are used.

APPLICATION SECTION

Charge Current Sensing Resistor Selection Guidelines

Both the termination current range and charge current range depend on the sensing resistor (R_{SNS}). The termination current step (I_{O(TERM_STEP)}) can be calculated using [Equation 1](#):

$$I_{O(TERM_STEP)} = \frac{V_{I(TERM0)}}{R_{(SNS)}} \quad (1)$$

[Table 10](#) shows the termination current settings for three sensing resistors.

Table 10. Termination Current Settings for 55-mΩ, 68-mΩ, 100-mΩ Sense Resistors

BIT	V _{I(TERM)} (mV)	I _(TERM) (mA) R _(SNS) = 55mΩ	I _(TERM) (mA) R _(SNS) = 68mΩ	I _(TERM) (mA) R _(SNS) = 100mΩ
V _{I(TERM2)}	13.6	247	200	136
V _{I(TERM1)}	6.8	124	100	68
V _{I(TERM0)}	3.4	62	50	34
Offset	3.4	62	50	34

For example, with a 68-mΩ sense resistor, V_(ITERM2)=1, V_(ITERM1)=0, and V_(ITERM0)=1, I_{TERM} = [(13.6mV x 1) + (6.8mV x 0) + (3.4mV x 1) + 3.4mV] / 68mΩ = 200mA + 0 + 50mA + 50mA = 300mA.

The charge current step (I_{O(CHARGE_STEP)}) is calculated using [Equation 2](#):

$$I_{O(CHARGE_STEP)} = \frac{V_{I(CHRG0)}}{R_{(SNS)}} \quad (2)$$

[Table 11](#) shows the charge current settings for three sensing resistors.

Table 11. Charge Current Settings for 55-mΩ, 68-mΩ and 100-mΩ Sense Resistors

BIT	V _{I(REG)} (mV)	I _{O(CHARGE)} (mA) R _(SNS) = 55mΩ	I _{O(CHARGE)} (mA) R _(SNS) = 68mΩ	I _{O(CHARGE)} (mA) R _(SNS) = 100mΩ
V _{I(CHRG3)}	54.4	989	800	544
V _{I(CHRG2)}	27.2	495	400	272
V _{I(CHRG1)}	13.6	247	200	136
V _{I(CHRG0)}	6.8	124	100	68
Offset	37.4	680	550	374

For example, with a 68-mΩ sense resistor, V_(CHRG3)=1, V_(CHRG2)=0, V_(CHRG1)=0, and V_(CHRG0)=1, I_{TERM} = [(54.4mV x 1) + (27.2mV x 0) + (13.6mV x 0) + (6.8mV x 1) + 37.4mV] / 68mΩ = 800mA + 0 + 0 + 100mA = 900mA.

Output Inductor and Capacitance Selection Guidelines

The IC provides internal loop compensation. With the internal loop compensation, the highest stability occurs when the LC resonant frequency, f_o, is approximately 40 kHz (20 kHz to 80 kHz). Equation 3 can be used to calculate the value of the output inductor, L_{OUT}, and output capacitor, C_{OUT}.

$$f_o = \frac{1}{2\pi \times \sqrt{L_{OUT} \times C_{OUT}}} \quad (3)$$

To reduce the output voltage ripple, a ceramic capacitor with the capacitance between 4.7 μF and 47 μF is recommended for C_{OUT}, see the application section for components selection.

POWER TOPOLOGIES

System Load After Sensing Resistor

One of the simpler high-efficiency topologies connects the system load directly across the battery pack, as shown in Figure 33. The input voltage has been converted to a usable system voltage with good efficiency from the input. When the input power is on, it supplies the system load and charges the battery pack at the same time. When the input power is off, the battery pack powers the system directly.

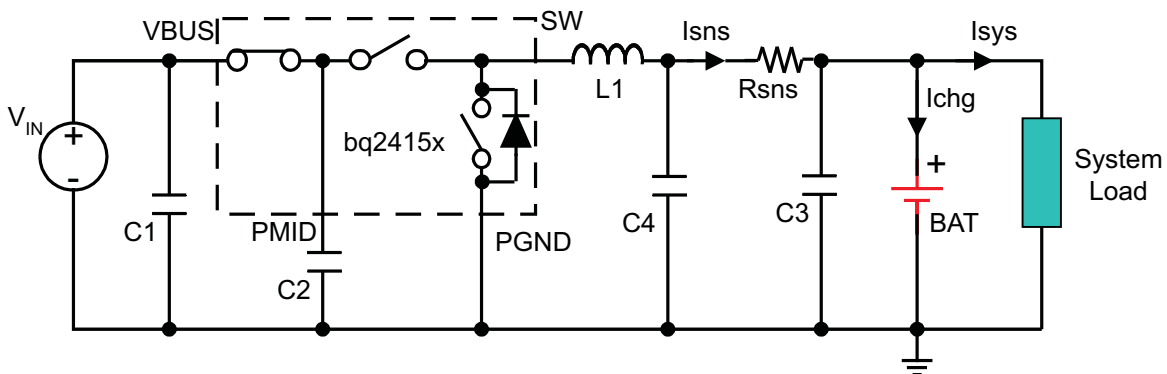

Figure 33. System Load After Sensing Resistor

The advantages:

1. When the AC adapter is disconnected, the battery pack powers the system load with minimum power dissipation. Consequently, the time that the system runs on the battery pack can be maximized.
2. It reduces the number of external path selection components and offers a low-cost solution.
3. Dynamic power management (DPM) can be achieved. The total of the charge current and the system current can be limited to a desired value by setting the charge current value. When the system current increases, the charge current drops by the same amount. As a result, no potential over-current or over-heating issues are caused by excessive system load demand.

4. The total input current can be limited to a desired value by setting the input current limit value. USB specifications can be met easily.
5. The supply voltage variation range for the system can be minimized.
6. The input current soft-start can be achieved by the generic soft-start feature of the IC.

Design considerations and potential issues:

1. If the system always demands a high current (but lower than the regulation current), the battery charging never terminates. Thus, the battery is always charged, and its lifetime may be reduced.
2. Because the total current regulation threshold is fixed and the system always demands some current, the battery may not be charged with a full-charge rate and thus may lead to a longer charge time.
3. If the system load current is large after the charger has been terminated, the IR drop across the battery impedance may cause the battery voltage to drop below the refresh threshold and start a new charge cycle. The charger would then terminate due to low charge current. Therefore, the charger would cycle between charging and terminating. If the load is smaller, the battery has to discharge down to the refresh threshold, resulting in a much slower cycling.
4. In a charger system, the charge current is typically limited to about 30mA, if the sensed battery voltage is below 2V short circuit protection threshold. This results in low power availability at the system bus. If an external supply is connected and the battery is deeply discharged, below the short circuit protection threshold, the charge current is clamped to the short circuit current limit. This then is the current available to the system during the power-up phase. Most systems cannot function with such limited supply current, and the battery supplements the additional power required by the system. Note that the battery pack is already at the depleted condition, and it discharges further until the battery protector opens, resulting in a system shutdown.
5. If the battery is below the short circuit threshold and the system requires a bias current budget lower than the short circuit current limit, the end-equipment will be operational, but the charging process can be affected depending on the current left to charge the battery pack. Under extreme conditions, the system current is close to the short circuit current levels and the battery may not reach the fast-charge region in a timely manner. As a result, the safety timers flag the battery pack as defective, terminating the charging process. Because the safety timer cannot be disabled, the inserted battery pack must not be depleted to make the application possible.
6. If the battery pack voltage is too low, highly depleted, totally dead or even shorted, the system voltage is clamped by the battery and it cannot operate even if the input power is on.

DESIGN EXAMPLE FOR TYPICAL APPLICATION CIRCUIT

Systems Design Specifications:

- $V_{BUS} = 5\text{ V}$
 - $V_{BAT} = 4.2\text{ V}$ (1-Cell)
 - $I_{(charge)} = 1.25\text{ A}$
 - Inductor ripple current = 30% of fast charge current
1. Determine the inductor value (L_{OUT}) for the specified charge current ripple:

$$L_{OUT} = \frac{V_{BAT} \times (V_{BUS} - V_{BAT})}{V_{BUS} \times f \times \Delta I_L}$$

, the worst case is when battery voltage is as close as to half of the input voltage.

$$L_{OUT} = \frac{2.5 \times (5 - 2.5)}{5 \times (3 \times 10^6) \times 1.25 \times 0.3} \quad (4)$$

$$L_{OUT} = 1.11\ \mu\text{H}$$

Select the output inductor to standard 1 μH . Calculate the total ripple current with using the 1- μH inductor:

$$\Delta I_L = \frac{V_{BAT} \times (V_{BUS} - V_{BAT})}{V_{BUS} \times f \times L_{OUT}} \quad (5)$$

$$\Delta I_L = \frac{2.5 \times (5 - 2.5)}{5 \times (3 \times 10^6) \times (1 \times 10^{-6})} \quad (6)$$

$$\Delta I_L = 0.42 \text{ A}$$

Calculate the maximum output current:

$$I_{LPK} = I_{OUT} + \frac{\Delta I_L}{2} \quad (7)$$

$$I_{LPK} = 1.25 + \frac{0.42}{2} \quad (8)$$

$$I_{LPK} = 1.46 \text{ A}$$

Select 2.5mm by 2mm 1- μ H 1.5-A surface mount multi-layer inductor. The suggested inductor part numbers are shown as following.

Table 12. Inductor Part Numbers

PART NUMBER	INDUCTANCE	SIZE	MANUFACTURER
LQM2HPN1R0MJ0	1 μ H	2.5 x 2.0 mm	Murata
MIPS2520D1R0	1 μ H	2.5 x 2.0 mm	FDK
MDT2520-CN1R0M	1 μ H	2.5 x 2.0 mm	TOKO
CP1008	1 μ H	2.5 x 2.0 mm	Inter-Technical

2. Determine the output capacitor value (C_{OUT}) using 40 kHz as the resonant frequency:

$$f_0 = \frac{1}{2\pi \times \sqrt{L_{OUT} \times C_{OUT}}} \quad (9)$$

$$C_{OUT} = \frac{1}{4\pi^2 \times f_0^2 \times L_{OUT}} \quad (10)$$

$$C_{OUT} = \frac{1}{4\pi^2 \times (40 \times 10^3)^2 \times (1 \times 10^{-6})} \quad (11)$$

$$C_{OUT} = 15.8 \mu\text{F}$$

Select two 0603 X5R 6.3V 10- μ F ceramic capacitors in parallel i.e., Murata GRM188R60J106M.

3. Determine the sense resistor using the following equation:

$$R_{(SNS)} = \frac{V_{(RSNS)}}{I_{(CHARGE)}} \quad (12)$$

The maximum sense voltage across the sense resistor is 85 mV. In order to get a better current regulation accuracy, $V_{(RSNS)}$ should equal 85mV, and calculate the value for the sense resistor.

$$R_{(SNS)} = \frac{85\text{mV}}{1.25\text{A}} \quad (13)$$

$$R_{(SNS)} = 68 \text{ m}\Omega$$

This is a standard value. If it is not a standard value, then choose the next close value and calculate the real charge current. Calculate the power dissipation on the sense resistor:

$$P_{(RSNS)} = I_{(CHARGE)}^2 \times R_{(SNS)}$$

$$P_{(RSNS)} = 1.25^2 \times 0.068$$

$$P_{(RSNS)} = 0.106 \text{ W}$$

Select 0402 0.125-W 68-m Ω 2% sense resistor, i.e. Panasonic ERJ2BWGR068.

4. Measured efficiency and total power loss with different inductors are shown in [Figure 34](#). SW node and inductor current waveform are shown in [Figure 35](#).

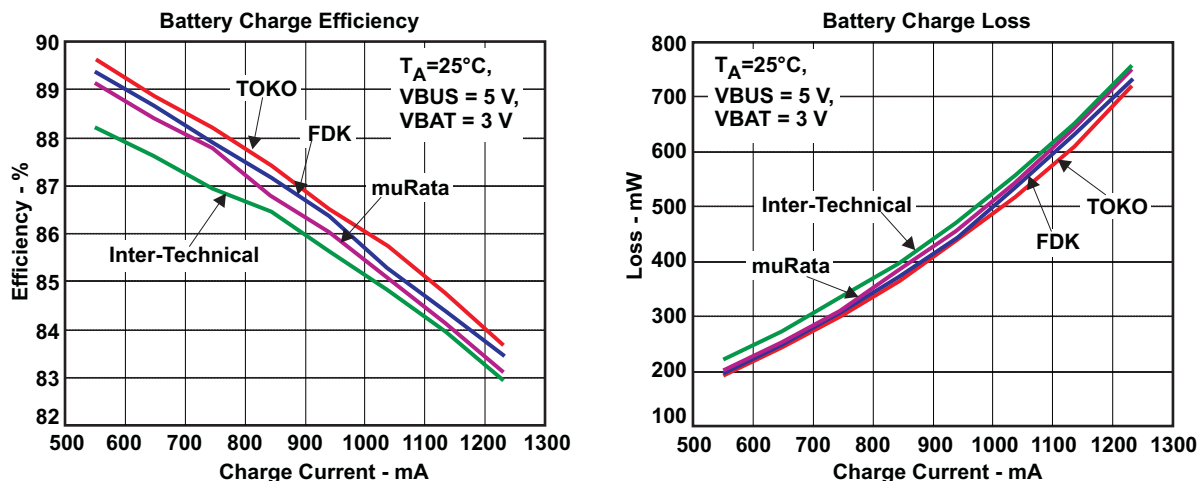
Figure 34. Measured Efficiency and Power Loss

PCB LAYOUT CONSIDERATION

It is important to pay special attention to the PCB layout. The following provides some guidelines:

- To obtain optimal performance, the power input capacitors, connected from input to PGND, should be placed as close as possible to the pin. The output inductor should be placed close to the IC and the output capacitor connected between the inductor and PGND of the IC. The intent is to minimize the current path loop area from the SW pin through the LC filter and back to the PGND pin. To prevent high frequency oscillation problems, proper layout to minimize high frequency current path loop is critical. (See [Figure 35](#).) The sense resistor should be adjacent to the junction of the inductor and output capacitor. Route the sense leads connected across the RSNS back to the IC, close to each other (minimize loop area) or on top of each other on adjacent layers (do not route the sense leads through a high-current path). (See [Figure 36](#).)
- Place all decoupling capacitors close to their respective IC pins and close to PGND (do not place components such that routing interrupts power stage currents). All small control signals should be routed away from the high current paths.
- The PCB should have a ground plane (return) connected directly to the return of all components through vias (two vias per capacitor for power-stage capacitors, two vias for the IC PGND, one via per capacitor for small-signal components). A star ground design approach is typically used to keep circuit block currents isolated (high-power/low-power small-signal) which reduces noise-coupling and ground-bounce issues. A single ground plane for this design gives good results. With this small layout and a single ground plane, there is no ground-bounce issue, and having the components segregated minimizes coupling between signals.
- The high-current charge paths into VBUS, PMID and from the SW pins must be sized appropriately for the maximum charge current in order to avoid voltage drops in these traces. The PGND pins should be connected to the ground plane to return current through the internal low-side FET.
- Place 4.7 μ F input capacitor as close to PMID pin and PGND pin as possible to make high frequency current loop area as small as possible. Place 1 μ F input capacitor as close to VBUS pin and PGND pin as possible to make high frequency current loop area as small as possible (see [Figure 37](#)).

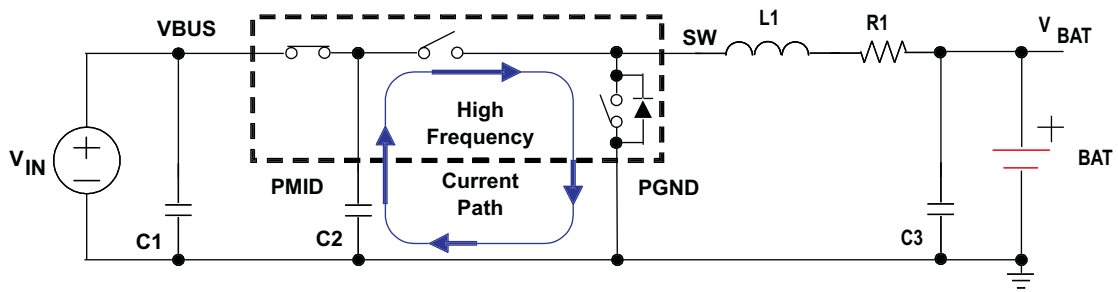

Figure 35. High Frequency Current Path

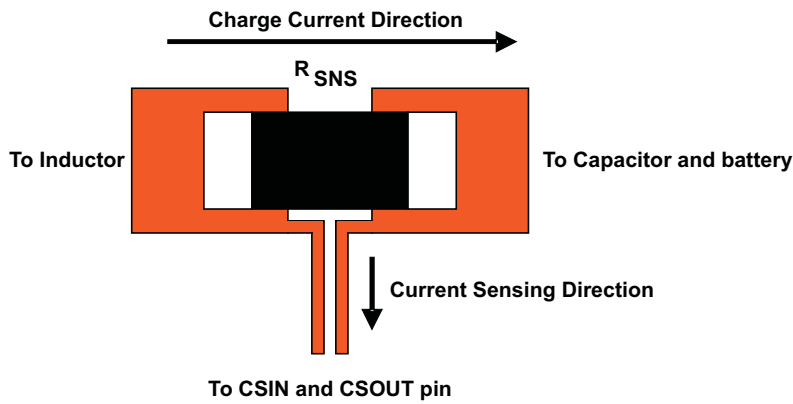

Figure 36. Sensing Resistor PCB Layout

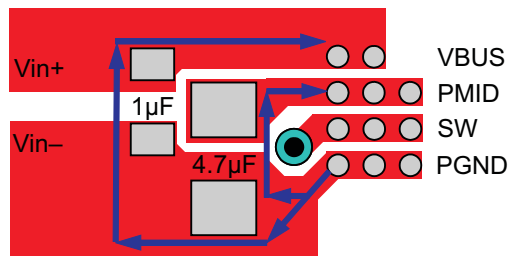
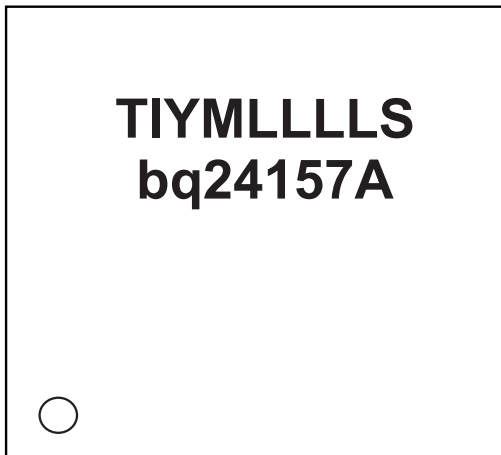

Figure 37. Input Capacitor Position and PCB Layout Example

PACKAGE SUMMARY

CHIP SCALE PACKAGE
(Top Side Symbol For bq24157)



WCSP PACKAGE
(Top View)

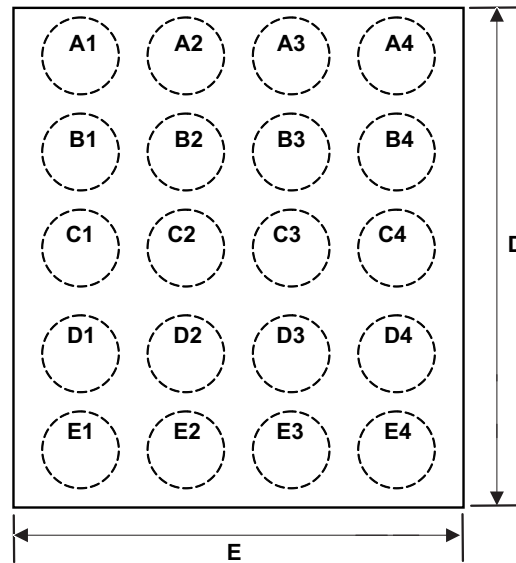

0-Pin A1 Marker, TI-TI Letters, YM- Year Month Date Code, LLLL-Lot Trace Code, S-Assembly Site Code

CHIP SCALE PACKAGING DIMENSIONS

The bq24157 device is available in a 20-bump chip scale package (YFF, NanoFree™).

The package dimensions are:

D	E
Max = 2.17mm	Max = 2.03 mm
Min = 2.11 mm	Min = 1.97 mm

REVISION HISTORY

Changes from Original (September 2012) to Revision A	Page
Deleted capacitor C _{O2} from the Typical Application Circuit	1
Deleted capacitor C _{O2} from Figure 2	8

PACKAGING INFORMATION

Orderable Device	Status (1)	Package Type	Package Drawing	Pins	Package Qty	Eco Plan (2)	Lead/Ball Finish	MSL Peak Temp (3)	Op Temp (°C)	Top-Side Markings (4)	Samples
BQ24157YFFR	ACTIVE	DSBGA	YFF	20	3000	Green (RoHS & no Sb/Br)	SNAGCU	Level-1-260C-UNLIM		BQ24157A	Samples
BQ24157YFFT	ACTIVE	DSBGA	YFF	20	250	Green (RoHS & no Sb/Br)	SNAGCU	Level-1-260C-UNLIM		BQ24157A	Samples

(1) The marketing status values are defined as follows:

ACTIVE: Product device recommended for new designs.

LIFEBUY: TI has announced that the device will be discontinued, and a lifetime-buy period is in effect.

NRND: Not recommended for new designs. Device is in production to support existing customers, but TI does not recommend using this part in a new design.

PREVIEW: Device has been announced but is not in production. Samples may or may not be available.

OBSOLETE: TI has discontinued the production of the device.

(2) Eco Plan - The planned eco-friendly classification: Pb-Free (RoHS), Pb-Free (RoHS Exempt), or Green (RoHS & no Sb/Br) - please check <http://www.ti.com/productcontent> for the latest availability information and additional product content details.

TBD: The Pb-Free/Green conversion plan has not been defined.

Pb-Free (RoHS): TI's terms "Lead-Free" or "Pb-Free" mean semiconductor products that are compatible with the current RoHS requirements for all 6 substances, including the requirement that lead not exceed 0.1% by weight in homogeneous materials. Where designed to be soldered at high temperatures, TI Pb-Free products are suitable for use in specified lead-free processes.

Pb-Free (RoHS Exempt): This component has a RoHS exemption for either 1) lead-based flip-chip solder bumps used between the die and package, or 2) lead-based die adhesive used between the die and leadframe. The component is otherwise considered Pb-Free (RoHS compatible) as defined above.

Green (RoHS & no Sb/Br): TI defines "Green" to mean Pb-Free (RoHS compatible), and free of Bromine (Br) and Antimony (Sb) based flame retardants (Br or Sb do not exceed 0.1% by weight in homogeneous material)

(3) MSL, Peak Temp. -- The Moisture Sensitivity Level rating according to the JEDEC industry standard classifications, and peak solder temperature.

(4) Multiple Top-Side Markings will be inside parentheses. Only one Top-Side Marking contained in parentheses and separated by a "~" will appear on a device. If a line is indented then it is a continuation of the previous line and the two combined represent the entire Top-Side Marking for that device.

Important Information and Disclaimer: The information provided on this page represents TI's knowledge and belief as of the date that it is provided. TI bases its knowledge and belief on information provided by third parties, and makes no representation or warranty as to the accuracy of such information. Efforts are underway to better integrate information from third parties. TI has taken and continues to take reasonable steps to provide representative and accurate information but may not have conducted destructive testing or chemical analysis on incoming materials and chemicals. TI and TI suppliers consider certain information to be proprietary, and thus CAS numbers and other limited information may not be available for release.

In no event shall TI's liability arising out of such information exceed the total purchase price of the TI part(s) at issue in this document sold by TI to Customer on an annual basis.

YFF (R-XBGA-N20)

DIE-SIZE BALL GRID ARRAY

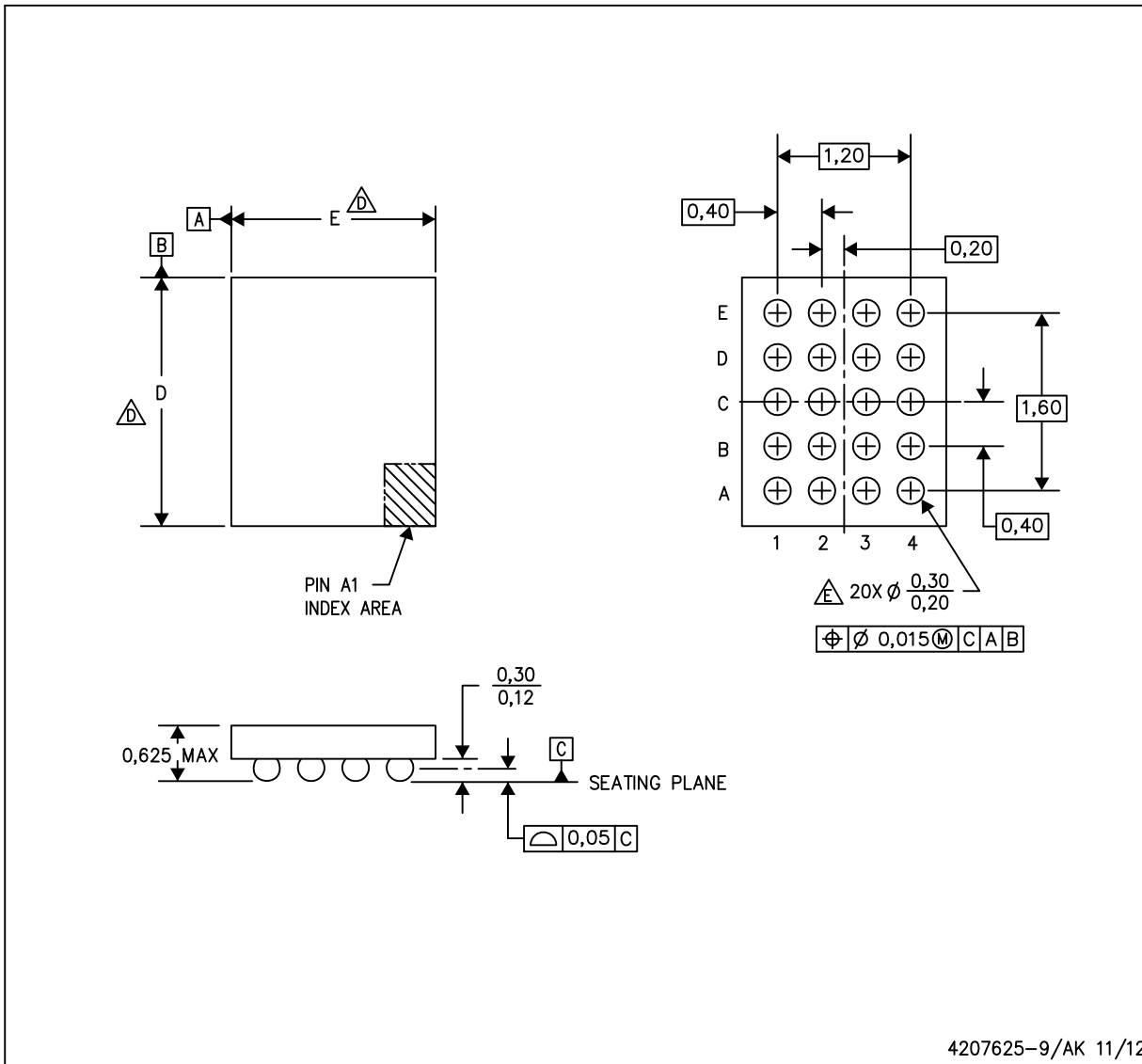

4207625-9/AK 11/12

- NOTES:
- A. All linear dimensions are in millimeters. Dimensioning and tolerancing per ASME Y14.5M-1994.
 - B. This drawing is subject to change without notice.
 - C. NanoFree™ package configuration.
 - \triangle The package size (Dimension D and E) of a particular device is specified in the device Product Data Sheet version of this drawing, in case it cannot be found in the product data sheet please contact a local TI representative.
 - E. Reference Product Data Sheet for array population.
5 x 4 matrix pattern is shown for illustration only.
 - F. This package contains Pb-free balls.

NanoFree is a trademark of Texas Instruments

IMPORTANT NOTICE

Texas Instruments Incorporated and its subsidiaries (TI) reserve the right to make corrections, enhancements, improvements and other changes to its semiconductor products and services per JESD46, latest issue, and to discontinue any product or service per JESD48, latest issue. Buyers should obtain the latest relevant information before placing orders and should verify that such information is current and complete. All semiconductor products (also referred to herein as "components") are sold subject to TI's terms and conditions of sale supplied at the time of order acknowledgment.

TI warrants performance of its components to the specifications applicable at the time of sale, in accordance with the warranty in TI's terms and conditions of sale of semiconductor products. Testing and other quality control techniques are used to the extent TI deems necessary to support this warranty. Except where mandated by applicable law, testing of all parameters of each component is not necessarily performed.

TI assumes no liability for applications assistance or the design of Buyers' products. Buyers are responsible for their products and applications using TI components. To minimize the risks associated with Buyers' products and applications, Buyers should provide adequate design and operating safeguards.

TI does not warrant or represent that any license, either express or implied, is granted under any patent right, copyright, mask work right, or other intellectual property right relating to any combination, machine, or process in which TI components or services are used. Information published by TI regarding third-party products or services does not constitute a license to use such products or services or a warranty or endorsement thereof. Use of such information may require a license from a third party under the patents or other intellectual property of the third party, or a license from TI under the patents or other intellectual property of TI.

Reproduction of significant portions of TI information in TI data books or data sheets is permissible only if reproduction is without alteration and is accompanied by all associated warranties, conditions, limitations, and notices. TI is not responsible or liable for such altered documentation. Information of third parties may be subject to additional restrictions.

Resale of TI components or services with statements different from or beyond the parameters stated by TI for that component or service voids all express and any implied warranties for the associated TI component or service and is an unfair and deceptive business practice. TI is not responsible or liable for any such statements.

Buyer acknowledges and agrees that it is solely responsible for compliance with all legal, regulatory and safety-related requirements concerning its products, and any use of TI components in its applications, notwithstanding any applications-related information or support that may be provided by TI. Buyer represents and agrees that it has all the necessary expertise to create and implement safeguards which anticipate dangerous consequences of failures, monitor failures and their consequences, lessen the likelihood of failures that might cause harm and take appropriate remedial actions. Buyer will fully indemnify TI and its representatives against any damages arising out of the use of any TI components in safety-critical applications.

In some cases, TI components may be promoted specifically to facilitate safety-related applications. With such components, TI's goal is to help enable customers to design and create their own end-product solutions that meet applicable functional safety standards and requirements. Nonetheless, such components are subject to these terms.

No TI components are authorized for use in FDA Class III (or similar life-critical medical equipment) unless authorized officers of the parties have executed a special agreement specifically governing such use.

Only those TI components which TI has specifically designated as military grade or "enhanced plastic" are designed and intended for use in military/aerospace applications or environments. Buyer acknowledges and agrees that any military or aerospace use of TI components which have **not** been so designated is solely at the Buyer's risk, and that Buyer is solely responsible for compliance with all legal and regulatory requirements in connection with such use.

TI has specifically designated certain components as meeting ISO/TS16949 requirements, mainly for automotive use. In any case of use of non-designated products, TI will not be responsible for any failure to meet ISO/TS16949.

Products

Audio	www.ti.com/audio
Amplifiers	amplifier.ti.com
Data Converters	dataconverter.ti.com
DLP® Products	www.dlp.com
DSP	dsp.ti.com
Clocks and Timers	www.ti.com/clocks
Interface	interface.ti.com
Logic	logic.ti.com
Power Mgmt	power.ti.com
Microcontrollers	microcontroller.ti.com
RFID	www.ti-rfid.com
OMAP Applications Processors	www.ti.com/omap
Wireless Connectivity	www.ti.com/wirelessconnectivity

Applications

Automotive and Transportation	www.ti.com/automotive
Communications and Telecom	www.ti.com/communications
Computers and Peripherals	www.ti.com/computers
Consumer Electronics	www.ti.com/consumer-apps
Energy and Lighting	www.ti.com/energy
Industrial	www.ti.com/industrial
Medical	www.ti.com/medical
Security	www.ti.com/security
Space, Avionics and Defense	www.ti.com/space-avionics-defense
Video and Imaging	www.ti.com/video

TI E2E Community

e2e.ti.com