



RF Power LDMOS Transistor

N-Channel Enhancement-Mode Lateral MOSFET

This 28 W asymmetrical Doherty RF power LDMOS transistor is designed for cellular base station applications requiring very wide instantaneous bandwidth capability covering the frequency range of 1880 to 2025 MHz.

1880–2025 MHz

- Typical Doherty single-carrier W-CDMA performance: $V_{DD} = 28$ Vdc, $I_{DQA} = 400$ mA, $V_{GSB} = 0.2$ Vdc, $P_{out} = 28$ W Avg., input signal PAR = 9.9 dB @ 0.01% probability on CCDF.

Frequency	G_{ps} (dB)	η_D (%)	Output PAR (dB)	ACPR (dBc)
1880 MHz	16.8	45.8	8.3	-32.5
1960 MHz	17.0	47.7	8.2	-33.5
2025 MHz	16.5	47.9	8.0	-34.3

Features

- Advanced high performance in-package Doherty
- Designed for wide instantaneous bandwidth applications
- Greater negative gate-source voltage range for improved Class C operation
- Able to withstand extremely high output VSWR and broadband operating conditions
- Designed for digital predistortion error correction systems

A2T20H160W04NR3

1880–2025 MHz, 28 W AVG., 28 V AIRFAST RF POWER LDMOS TRANSISTOR



OM-780-4L PLASTIC

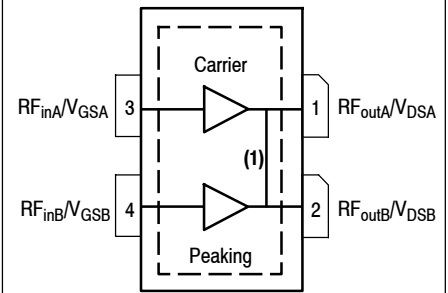

(Top View)

Note: Exposed backside of the package is the source terminal for the transistor.

Figure 1. Pin Connections

1. Pin connections 1 and 2 are DC coupled and RF independent.

Table 1. Maximum Ratings

Rating	Symbol	Value	Unit
Drain-Source Voltage	V_{DSS}	-0.5, +65	Vdc
Gate-Source Voltage	V_{GS}	-6.0, +10	Vdc
Operating Voltage	V_{DD}	32, +0	Vdc
Storage Temperature Range	T_{stg}	-65 to +150	°C
Case Operating Temperature Range	T_C	-40 to +125	°C
Operating Junction Temperature Range (1,2)	T_J	-40 to +225	°C

Table 2. Thermal Characteristics

Characteristic	Symbol	Value (2,3)	Unit
Thermal Resistance, Junction to Case Case Temperature 75°C, 28 W Avg., W-CDMA, 28 Vdc, $I_{DQA} = 400$ mA, $V_{GSB} = 0.2$ Vdc, $f = 1960$ MHz	$R_{\theta JC}$	0.45	°C/W

Table 3. ESD Protection Characteristics

Test Methodology	Class
Human Body Model (per JESD22-A114)	2
Machine Model (per EIA/JESD22-A115)	B
Charge Device Model (per JESD22-C101)	IV

Table 4. Moisture Sensitivity Level

Test Methodology	Rating	Package Peak Temperature	Unit
Per JESD22-A113, IPC/JEDEC J-STD-020	3	260	°C

Table 5. Electrical Characteristics ($T_A = 25^\circ\text{C}$ unless otherwise noted)

Characteristic	Symbol	Min	Typ	Max	Unit
----------------	--------	-----	-----	-----	------

Off Characteristics (4)

Zero Gate Voltage Drain Leakage Current ($V_{DS} = 65$ Vdc, $V_{GS} = 0$ Vdc)	I_{DSS}	—	—	10	μAdc
Zero Gate Voltage Drain Leakage Current ($V_{DS} = 32$ Vdc, $V_{GS} = 0$ Vdc)	I_{DSS}	—	—	5	μAdc
Gate-Source Leakage Current ($V_{GS} = 5$ Vdc, $V_{DS} = 0$ Vdc)	I_{GSS}	—	—	1	μAdc

On Characteristics - Side A, Carrier

Gate Threshold Voltage ($V_{DS} = 10$ Vdc, $I_D = 80$ μAdc)	$V_{GS(th)}$	1.4	1.8	2.2	Vdc
Gate Quiescent Voltage ($V_{DD} = 28$ Vdc, $I_{DA} = 400$ mAdc, Measured in Functional Test)	$V_{GSA(Q)}$	2.2	2.6	3.0	Vdc
Drain-Source On-Voltage ($V_{GS} = 10$ Vdc, $I_D = 0.8$ Adc)	$V_{DS(on)}$	0.1	0.15	0.3	Vdc

On Characteristics - Side B, Peaking

Gate Threshold Voltage ($V_{DS} = 10$ Vdc, $I_D = 110$ μAdc)	$V_{GS(th)}$	0.8	1.2	1.6	Vdc
Drain-Source On-Voltage ($V_{GS} = 10$ Vdc, $I_D = 1.1$ Adc)	$V_{DS(on)}$	0.1	0.15	0.3	Vdc

1. Continuous use at maximum temperature will affect MTTF.
2. MTTF calculator available at <http://www.nxp.com/RF/calculators>.
3. Refer to AN1955, *Thermal Measurement Methodology of RF Power Amplifiers*. Go to <http://www.nxp.com/RF> and search for AN1955.
4. Side A and Side B are tied together for these measurements.

(continued)

Table 5. Electrical Characteristics ($T_A = 25^\circ\text{C}$ unless otherwise noted) (continued)

Characteristic	Symbol	Min	Typ	Max	Unit
Functional Tests ^(1,2,3) (In NXP Doherty Test Fixture, 50 ohm system) $V_{DD} = 28\text{ Vdc}$, $I_{DQA} = 400\text{ mA}$, $V_{GSB} = 0.2\text{ Vdc}$, $P_{out} = 28\text{ W Avg.}$, $f = 1960\text{ MHz}$, Single-Carrier W-CDMA, IQ Magnitude Clipping, Input Signal PAR = 9.9 dB @ 0.01% Probability on CCDF. ACPR measured in 3.84 MHz Channel Bandwidth @ $\pm 5\text{ MHz}$ Offset.					
Power Gain	G_{ps}	16.0	17.0	19.0	dB
Drain Efficiency	η_D	45.0	47.7	—	%
Output Peak-to-Average Ratio @ 0.01% Probability on CCDF	PAR	7.75	8.2	—	dB
Adjacent Channel Power Ratio	ACPR	—	-33.5	-28.0	dBc

Load Mismatch ⁽³⁾ (In NXP Doherty Test Fixture, 50 ohm system) $I_{DQA} = 400\text{ mA}$, $V_{GSB} = 0.2\text{ Vdc}$, $f = 1960\text{ MHz}$

VSWR 10:1 at 32 Vdc, 158 W CW Output Power (3 dB Input Overdrive from 90 W CW Rated Power)	No Device Degradation
---	-----------------------

Typical Performance ⁽³⁾ (In NXP Doherty Test Fixture, 50 ohm system) $V_{DD} = 28\text{ Vdc}$, $I_{DQA} = 400\text{ mA}$, $V_{GSB} = 0.2\text{ Vdc}$, 1880–2025 MHz Bandwidth

P_{out} @ 1 dB Compression Point, CW	P1dB	—	90	—	W
P_{out} @ 3 dB Compression Point ⁽⁴⁾	P3dB	—	200	—	W
AM/PM (Maximum value measured at the P3dB compression point across the 1880–2025 MHz bandwidth)	Φ	—	-9.1	—	°
VBW Resonance Point (IMD Third Order Intermodulation Inflection Point)	VBW _{res}	—	140	—	MHz
Gain Flatness in 145 MHz Bandwidth @ $P_{out} = 28\text{ W Avg.}$	G_F	—	0.5	—	dB
Gain Variation over Temperature (-30°C to +85°C)	ΔG	—	0.002	—	dB/°C
Output Power Variation over Temperature (-30°C to +85°C)	ΔP_{1dB}	—	0.003	—	dB/°C

Table 6. Ordering Information

Device	Tape and Reel Information	Package
A2T20H160W04NR3	R3 Suffix = 250 Units, 32 mm Tape Width, 13-inch Reel	OM-780-4L

- V_{DDA} and V_{ddb} must be tied together and powered by a single DC power supply.
- Part internally matched both on input and output.
- Measurement made with device in an asymmetrical Doherty configuration.
- P3dB = $P_{avg} + 7.0\text{ dB}$ where P_{avg} is the average output power measured using an unclipped W-CDMA single-carrier input signal where output PAR is compressed to 7.0 dB @ 0.01% probability on CCDF.

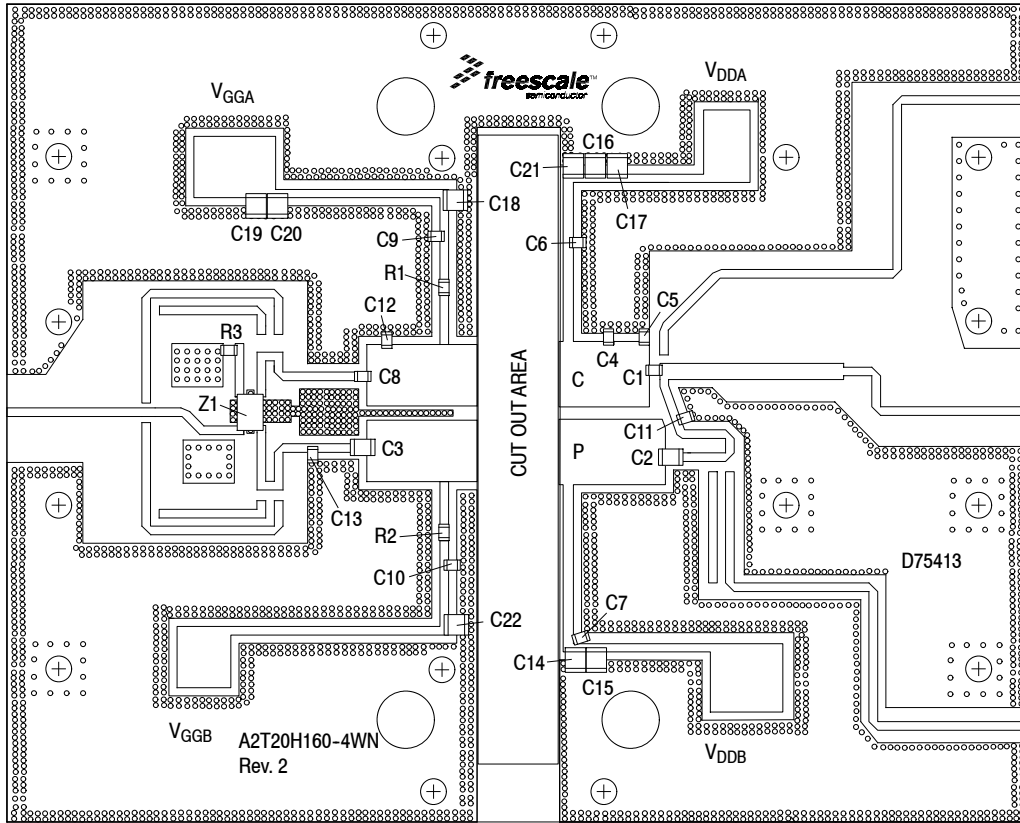

*C2 and C3 are mounted vertically.

Note: V_{DDA} and V_{DDB} must be tied together and powered by a single DC power supply.

Figure 2. A2T20H160W04NR3 Test Circuit Component Layout

Table 7. A2T20H160W04NR3 Test Circuit Component Designations and Values

Part	Description	Part Number	Manufacturer
C1	6.8 pF Chip Capacitor	ATC600F6R8BT250XT	ATC
C2, C3	12 pF Chip Capacitors	ATC100B120JT500XT	ATC
C4	1.2 pF Chip Capacitor	ATC600F1R2BT250XT	ATC
C5	0.6 pF Chip Capacitor	ATC600F0R6BT250XT	ATC
C6, C7, C8, C9, C10	12 pF Chip Capacitors	ATC600F120JT250XT	ATC
C11	0.4 pF Chip Capacitor	ATC600F0R4BT250XT	ATC
C12, C13	0.5 pF Chip Capacitors	ATC600F0R5BT250XT	ATC
C14, C15, C16, C17, C18, C19, C20, C21, C22	10 μ F Chip Capacitors	GRM32ER61H106KA12L	Murata
R1, R2	3.3 Ω , 1/2 W Chip Resistors	ERJ-14YJ3R3U	Panasonic
R3	50 Ω , 4 W Chip Resistor	CW12010T0050GBK	ATC
Z1	1800–2200 MHz Band, 90°, 2 dB Directional Coupler	X3C20F1-02S	Anaren
PCB	Rogers RO4350B, 0.020", $\epsilon_r = 3.66$	D75413	MTL

TYPICAL CHARACTERISTICS — 1880–2025 MHz

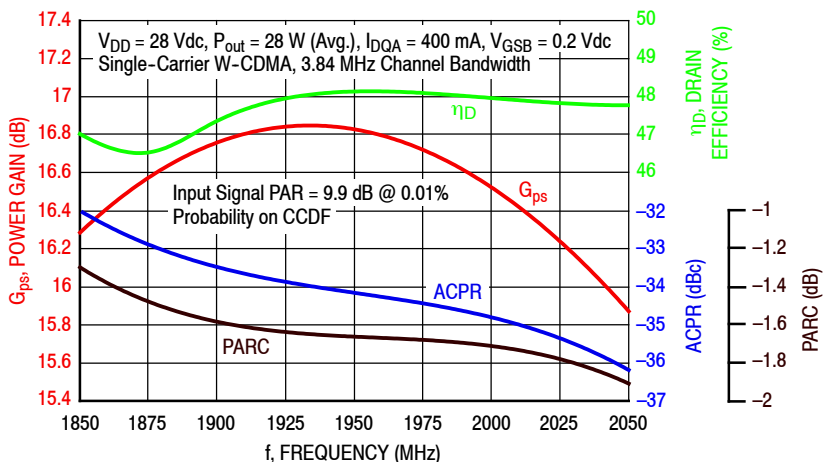

Figure 3. Single-Carrier Output Peak-to-Average Ratio Compression (PARC) Broadband Performance @ $P_{out} = 28$ Watts Avg.

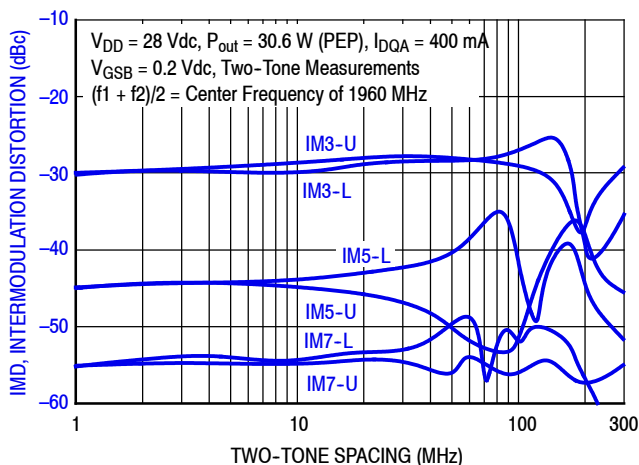

Figure 4. Intermodulation Distortion Products versus Two-Tone Spacing

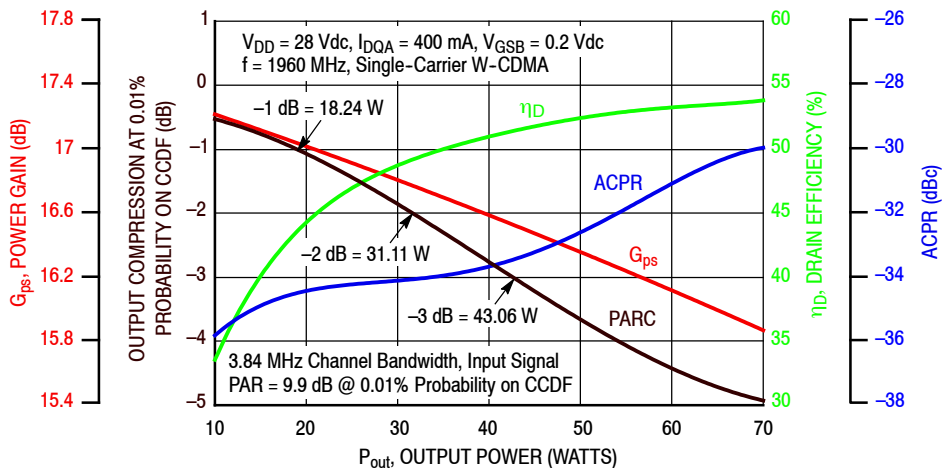

Figure 5. Output Peak-to-Average Ratio Compression (PARC) versus Output Power

TYPICAL CHARACTERISTICS — 1880–2025 MHz

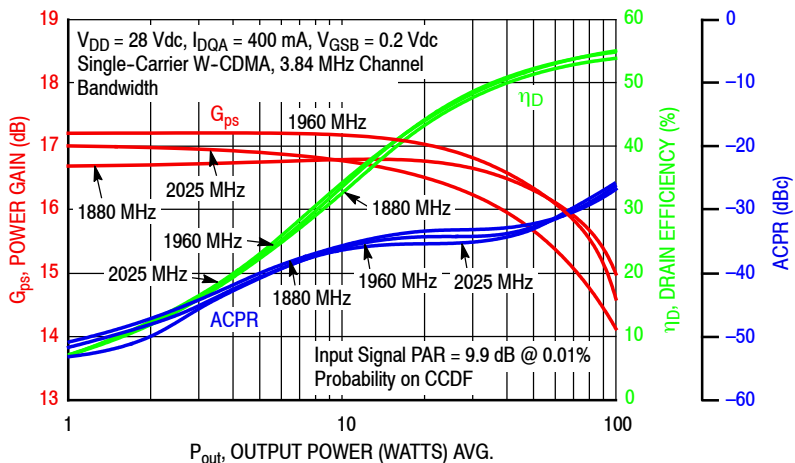

Figure 6. Single-Carrier W-CDMA Power Gain, Drain Efficiency and ACPR versus Output Power

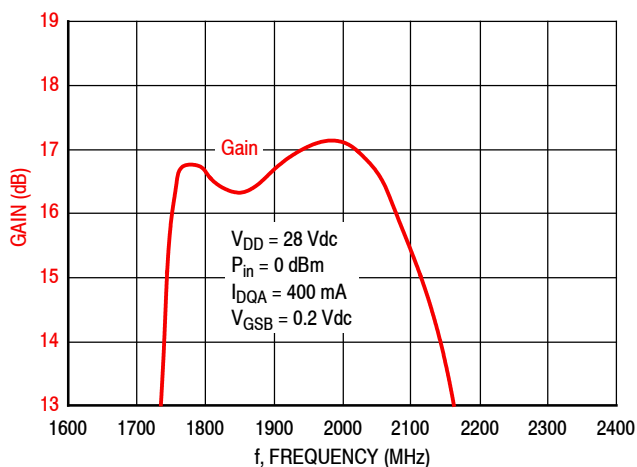
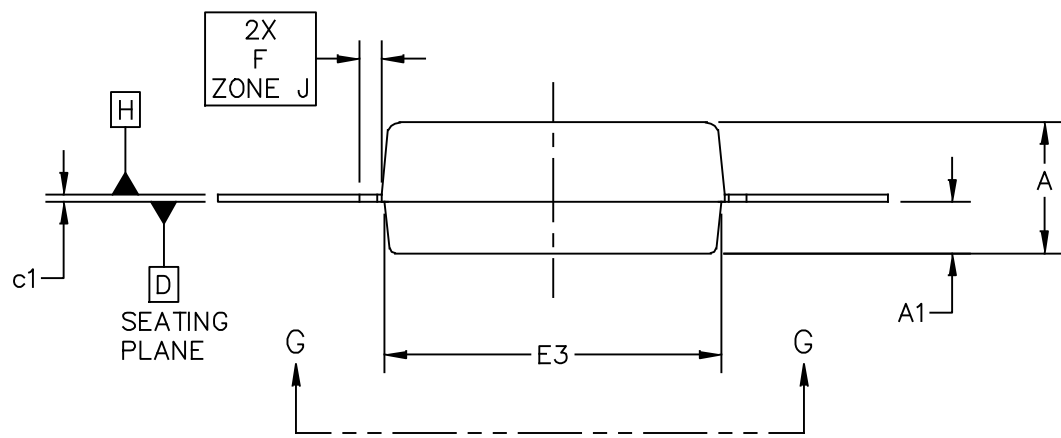
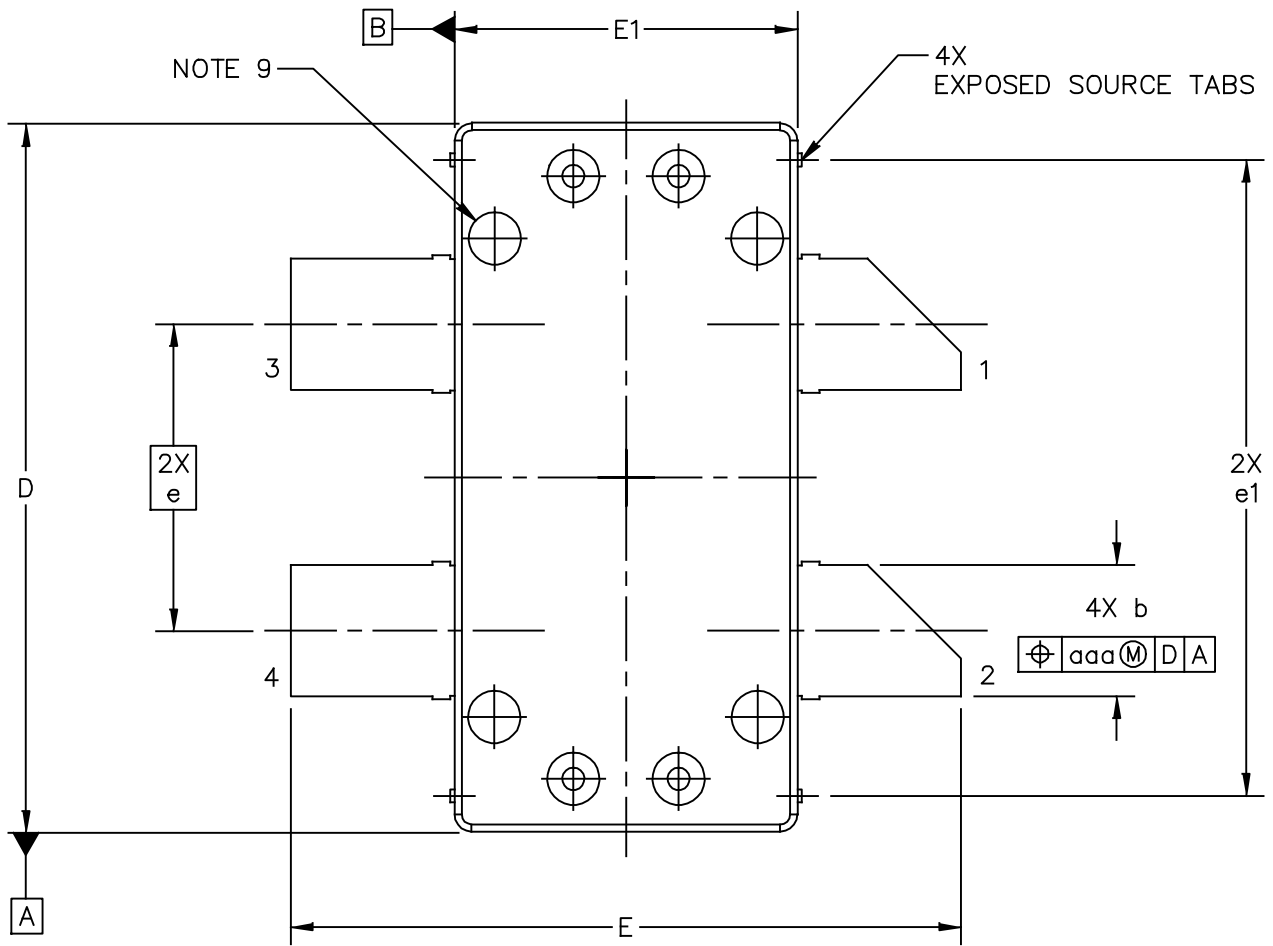

Figure 7. Broadband Frequency Response

PACKAGE DIMENSIONS



© NXP SEMICONDUCTORS N.V. ALL RIGHTS RESERVED	MECHANICAL OUTLINE	PRINT VERSION NOT TO SCALE
TITLE: OM780-4 STRAIGHT LEAD	DOCUMENT NO: 98ASA10833D	REV: B
	STANDARD: NON-JEDEC	
	SOT1818-4	16 MAR 2016

A2T20H160W04NR3

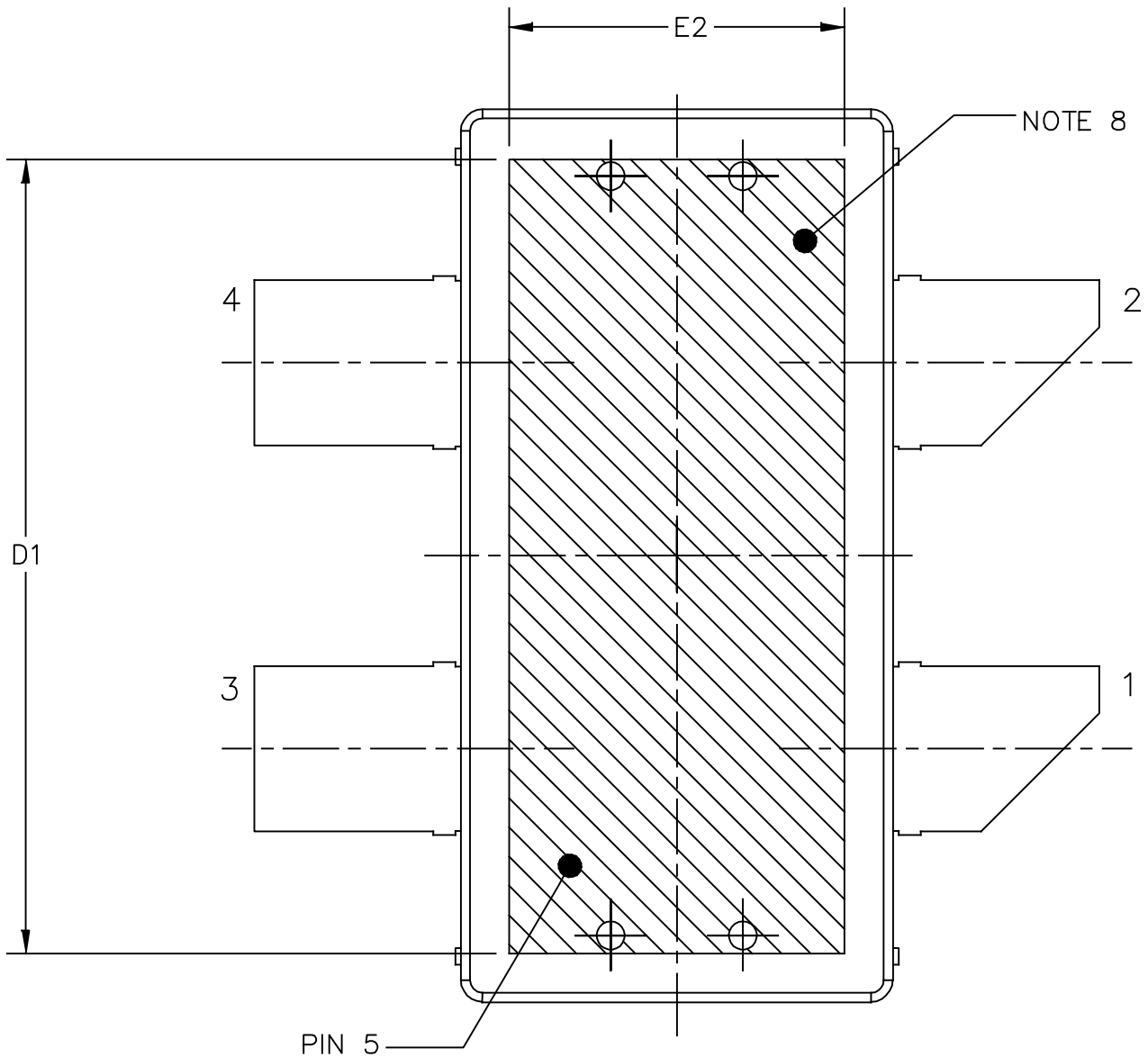

BOTTOM VIEW
VIEW G-G

© NXP SEMICONDUCTORS N.V. ALL RIGHTS RESERVED	MECHANICAL OUTLINE	PRINT VERSION NOT TO SCALE	
TITLE: OM780-4 STRAIGHT LEAD		DOCUMENT NO: 98ASA10833D	REV: B
		STANDARD: NON-JEDEC	
		SOT1818-4	16 MAR 2016

NOTES:

1. CONTROLLING DIMENSION: INCH
2. INTERPRET DIMENSIONS AND TOLERANCES PER ASME Y14.5M-1994.
3. DATUM PLANE -H- IS LOCATED AT TOP OF LEAD AND IS COINCIDENT WITH THE LEAD WHERE THE LEAD EXITS THE PLASTIC BODY AT THE TOP OF THE PARTING LINE.
4. DIMENSIONS "D" AND "E1" DO NOT INCLUDE MOLD PROTRUSION. ALLOWABLE PROTRUSION IS .006 PER SIDE. DIMENSIONS "D AND "E1" DO INCLUDE MOLD MISMATCH AND ARE DETERMINED AT DATUM PLANE -H-.
5. DIMENSION b DOES NOT INCLUDE DAMBAR PROTRUSION. ALLOWABLE DAMBAR PROTRUSION SHALL BE .005 TOTAL IN EXCESS OF THE b DIMENSION AT MAXIMUM MATERIAL CONDITION.
6. DATUMS -A- AND -B- TO BE DETERMINED AT DATUM PLANE -H-.
7. DIMENSION A1 APPLIES WITHIN ZONE "J" ONLY.
8. HATCHING REPRESENTS THE EXPOSED AREA OF THE HEAT SLUG. THE DIMENSIONS D1 AND E2 REPRESENT THE VALUES BETWEEN THE TWO OPPOSITE POINTS ALONG THE EDGES OF EXPOSED AREA OF HEAT SLUG.
9. DIMPLED HOLE REPRESENTS INPUT SIDE.

DIM	INCH		MILLIMETER		DIM	INCH		MILLIMETER	
	MIN	MAX	MIN	MAX		MIN	MAX	MIN	MAX
A	0.148	.152	3.76	3.86	b	.147	.153	3.73	3.89
A1	.059	.065	1.50	1.65	c1	.007	.011	0.18	0.28
D	.808	.812	20.52	20.62	e	.350 BSC		8.89 BSC	
D1	.720	----	18.29	----	e1	.721	.729	18.31	18.52
E	.762	.770	19.36	19.56					
E1	.390	.394	9.91	10.01	aaa	.004		0.10	
E2	.306	----	7.77	----					
E3	.383	.387	9.72	9.83					
F	.025 BSC		0.635 BSC						
© NXP SEMICONDUCTORS N.V. ALL RIGHTS RESERVED			MECHANICAL OUTLINE			PRINT VERSION NOT TO SCALE			
TITLE: OM780-4 STRAIGHT LEAD					DOCUMENT NO: 98ASA10833D REV: B				
					STANDARD: NON-JEDEC				
					SOT1818-4		16 MAR 2016		

PRODUCT DOCUMENTATION, SOFTWARE AND TOOLS

Refer to the following resources to aid your design process.

Application Notes

- AN1907: Solder Reflow Attach Method for High Power RF Devices in Over-Molded Plastic Packages
- AN1955: Thermal Measurement Methodology of RF Power Amplifiers

Engineering Bulletins

- EB212: Using Data Sheet Impedances for RF LDMOS Devices

Software

- Electromigration MTTF Calculator
- .s2p File

Development Tools

- Printed Circuit Boards

To Download Resources Specific to a Given Part Number:

1. Go to <http://www.nxp.com/RF>
2. Search by part number
3. Click part number link
4. Choose the desired resource from the drop down menu

REVISION HISTORY

The following table summarizes revisions to this document.

Revision	Date	Description
0	Aug. 2016	• Initial release of data sheet

How to Reach Us:

Home Page:
nxp.com

Web Support:
nxp.com/support

Information in this document is provided solely to enable system and software implementers to use NXP products. There are no express or implied copyright licenses granted hereunder to design or fabricate any integrated circuits based on the information in this document. NXP reserves the right to make changes without further notice to any products herein.

NXP makes no warranty, representation, or guarantee regarding the suitability of its products for any particular purpose, nor does NXP assume any liability arising out of the application or use of any product or circuit, and specifically disclaims any and all liability, including without limitation consequential or incidental damages. "Typical" parameters that may be provided in NXP data sheets and/or specifications can and do vary in different applications, and actual performance may vary over time. All operating parameters, including "typicals," must be validated for each customer application by customer's technical experts. NXP does not convey any license under its patent rights nor the rights of others. NXP sells products pursuant to standard terms and conditions of sale, which can be found at the following address: nxp.com/SalesTermsandConditions.

NXP, the NXP logo, Freescale, the Freescale logo, and Airfast are trademarks of NXP B.V. All other product or service names are the property of their respective owners.
© 2016 NXP B.V.

