

## FEATURES

**Nonreflective 50  $\Omega$  design**

**Low insertion loss: 1.5 dB at 4 GHz**

**High isolation: 50 dB at 4 GHz**

**High input linearity**

0.1 dB compression (P0.1dB): 34 dBm typical

Third-order intercept (IP3): 57 dBm typical

**High power handling at 85°C**

33 dBm through path

27 dBm terminated path

**ESD rating**

3.5 kV HBM, Class 2

**Single-supply or dual-supply operation**

Optional internal negative voltage generator (NVG)

**1.8 V logic-compatible control**

**4 mm  $\times$  4 mm, 24-lead LFCSP**

## APPLICATIONS

Cellular/4G infrastructure

Wireless infrastructure

Mobile radios

Test equipment

## GENERAL DESCRIPTION

The ADRF5250 is a general-purpose, single-pole, five-throw (SP5T), nonreflective switch manufactured using a silicon process. The ADRF5250 is available in a 4 mm  $\times$  4 mm, 24-lead lead frame chip scale package (LFCSP) and provides high isolation and low insertion loss from 100 MHz to 6 GHz.

## FUNCTIONAL BLOCK DIAGRAM

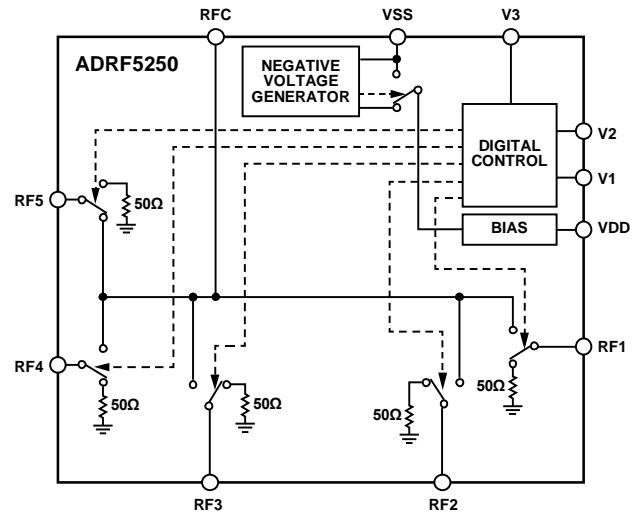

Figure 1.

The ADRF5250 incorporates a negative voltage generator to operate with a single positive supply voltage from 3.3 V to 5 V applied to the VDD pin when the VSS pin is connected to ground. The negative voltage generator can be disabled when an external negative supply voltage of  $-3.3$  V is applied to the VSS pin. The ADRF5250 provides a 1.8 V logic-compatible, 3-pin control interface.

**TABLE OF CONTENTS**

Features .....	1	Interface Schematics .....	7
Applications.....	1	Typical Performance Characteristics .....	8
Functional Block Diagram .....	1	Insertion Loss, Return Loss, And Isolation .....	8
General Description .....	1	Input Power Compression and Third-Order Intercept (IP3) ....	9
Revision History .....	2	Theory of Operation .....	11
Specifications.....	3	Applications Information .....	12
Absolute Maximum Ratings.....	5	Evaluation Board .....	12
ESD Caution.....	5	Outline Dimensions .....	14
Pin Configuration and Function Descriptions.....	6	Ordering Guide .....	14

**REVISION HISTORY**

**6/2017—Revision 0: Initial Version**

## SPECIFICATIONS

$V_{DD} = 5\text{ V}$ ,  $V_{SS} = 0\text{ V}$ ,  $V_1 = V_2 = V_3 = 0\text{ V}/V_{DD}$ ,  $T_{CASE} = 25^\circ\text{C}$ ,  $50\ \Omega$  system, unless otherwise noted.

Table 1.

Parameter	Symbol	Test Conditions/Comments	Min	Typ	Max	Unit
FREQUENCY RANGE	f		0.1		6	GHz
INSERTION LOSS						
Between RFC and RFx (On)		0.1 GHz to 2 GHz		1.3		dB
		2 GHz to 4 GHz		1.5		dB
		4 GHz to 6 GHz		1.8		dB
ISOLATION						
Between RFC and RFx (Off)		0.1 GHz to 2 GHz		55		dB
		2 GHz to 4 GHz		50		dB
		4 GHz to 6 GHz		46		dB
RETURN LOSS						
RFC and RFx (On)		0.1 GHz to 2 GHz		15		dB
		2 GHz to 4 GHz		13		dB
		4 GHz to 6 GHz		13		dB
RFx (Off)		0.1 GHz to 2 GHz		17		dB
		2 GHz to 4 GHz		15		dB
		4 GHz to 6 GHz		8		dB
SWITCHING						
Rise Time	$t_{RISE}$	10% to 90% of radio frequency (RF) output		40		ns
Fall Time	$t_{FALL}$	10% to 90% of RF output		80		ns
On and Off Time	$t_{ON}, t_{OFF}$	50% of digital control voltage ( $V_1, V_2, V_3$ ) to 90% of RF output		150		ns
Settling Time (RFx to RFx)						
0.1 dB		50% of $V_1, V_2, V_3$ to 0.1 dB of final RF output		400		ns
0.05 dB		50% of $V_1, V_2, V_3$ to 0.05 dB of final RF output		500		ns
INPUT LINEARITY						
0.1 dB Compression	P0.1dB			34		dB
Third-Order Intercept	IP3			57		dBm
SUPPLY CURRENT						
Positive	$I_{DD}$	VDD, VSS pins NVG enabled ( $V_{SS} = 0\text{ V}$ )		360		$\mu\text{A}$
		NVG disabled ( $V_{SS} = -3.3\text{ V}$ )		280		$\mu\text{A}$
Negative	$I_{SS}$	NVG disabled ( $V_{SS} = -3.3\text{ V}$ )		-60		$\mu\text{A}$
DIGITAL CONTROL INPUTS						
Voltage		V1, V2, V3 pins				
Low	$V_{INL}$	$V_{DD} = 3.3\text{ V}$	0		0.8	V
		$V_{DD} = 5\text{ V}$	0		1.2	V
High	$V_{INH}$	$V_{DD} = 3.3\text{ V}$	1.3		3.3	V
		$V_{DD} = 5\text{ V}$	1.6		5	V
Current						
Low and High	$I_{INL}, I_{INH}$	$V_{DD} = 3.3\text{ V to }5\text{ V}$		<1		$\mu\text{A}$

Parameter	Symbol	Test Conditions/Comments	Min	Typ	Max	Unit
RECOMMENDED OPERATING CONDITIONS						
Supply Voltage						
Positive	V <sub>DD</sub>		3.0		5.25	V
Negative	V <sub>SS</sub>		-3.45		-3.15	V
Digital Control Voltage	V <sub>1</sub> , V <sub>2</sub> , V <sub>3</sub>		0		V <sub>DD</sub>	V
Maximum RF Input Power <sup>1</sup>	P <sub>IN</sub>					
T <sub>CASE</sub> = 105°C		Through path (V <sub>DD</sub> = 3.3 V to 5 V)			30	dBm
		Terminated path			24	dBm
		Hot switching			24	dBm
T <sub>CASE</sub> = 85°C		Through path (V <sub>DD</sub> = 3.3 V to 5 V)			33	dBm
		Terminated path			27	dBm
		Hot switching			27	dBm
Case Temperature	T <sub>CASE</sub>		-40		+105	°C

<sup>1</sup> Exposure to levels between the recommended operating conditions and the absolute maximum rating conditions for extended period may affect device reliability.

## ABSOLUTE MAXIMUM RATINGS

For recommended operating conditions, see Table 1.

Table 2.

Parameter	Rating
Positive Supply Voltage ( $V_{DD}$ )	-0.3 V to +5.5 V
Negative Supply Voltage ( $V_{SS}$ )	-3.6 V to +0.3 V
Digital Control Input Voltage ( $V_1, V_2, V_3$ )	-0.3 V to $V_{DD} + 0.5$ V
RF Input Power	
Through Path	35 dBm
Terminated Path	34 dBm
All Off State, RFC as Input	24 dBm
Hot Switching	
RFC as Input	
RFx to RFx	32 dBm
All Off to RFx	24 dBm
RFx as Input	
RFx to RFx	34 dBm
All Off to RFx	34 dBm
Temperature	
Junction, $T_J$	135°C
Storage	-65°C to +150°C
Reflow (MSL3 Rating)	260°C
Junction to Case Thermal Resistance, $\theta_{JC}$	
Through Path	90°C/W
Terminated Path	100°C/W
ESD Sensitivity	
Human Body Model (HBM)	3.5 kV (Class 2)
Field Induced Device Model (FICDM)	1.25 kV (Class IV)

Stresses at or above those listed under Absolute Maximum Ratings may cause permanent damage to the product. This is a stress rating only; functional operation of the product at these or any other conditions above those indicated in the operational section of this specification is not implied. Operation beyond the maximum operating conditions for extended periods may affect product reliability.

Only one absolute maximum rating can be applied at any one time.

### ESD CAUTION



**ESD (electrostatic discharge) sensitive device.** Charged devices and circuit boards can discharge without detection. Although this product features patented or proprietary protection circuitry, damage may occur on devices subjected to high energy ESD. Therefore, proper ESD precautions should be taken to avoid performance degradation or loss of functionality.

## PIN CONFIGURATION AND FUNCTION DESCRIPTIONS

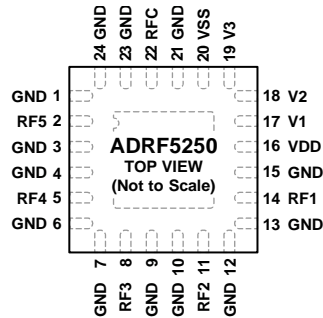

NOTES  
 1. EXPOSED PAD. THE EXPOSED PAD MUST BE CONNECTED TO THE RF/DC GROUND OF THE PCB.

155606-002

Figure 2. Pin Configuration

Table 3. Pin Function Descriptions

Pin No.	Mnemonic	Description
1, 3, 4, 6, 7, 9, 10, 12, 13, 15, 21, 23, 24	GND	Ground. These pins must be connected to the RF/dc ground of the printed circuit board (PCB).
2	RF5	RF Throw Port 5. This pin is dc coupled and no dc blocking capacitor is necessary when the RF line potential is within 0 V dc.
5	RF4	RF Throw Port 4. This pin is dc coupled and no dc blocking capacitor is necessary when the RF line potential is within 0 V dc.
8	RF3	RF Throw Port 3. This pin is dc coupled and no dc blocking capacitor is necessary when the RF line potential is within 0 V dc.
11	RF2	RF Throw Port 2. This pin is dc coupled and no dc blocking capacitor is necessary when the RF line potential is within 0 V dc.
14	RF1	RF Throw Port 1. This pin is dc coupled and no dc blocking capacitor is necessary when the RF line potential is within 0 V dc.
16	VDD	Positive Supply Voltage.
17	V1	Digital Input Voltage Applied to the Least Significant Bit (LSB) of Digital Interface for Controlling RF Path State. See Table 5.
18	V2	Digital Input Voltage Applied to the Second Bit of Digital Interface for Controlling RF Path State. See Table 5.
19	V3	Digital Input Voltage Applied to the Most Significant Bit (MSB) of Digital Interface for Controlling RF Path State. See Table 5.
20	VSS	Optional Negative Supply Voltage. This pin can be connected to ground to operate with the internal negative voltage generator. The internal negative voltage generator is disabled when this pin is connected to an external 3.3 V supply.
22	RFC	RF Common Port. This pin is dc-coupled and no dc blocking capacitor is necessary when the RF line potential is within 0 V dc.
	EPAD	Exposed Pad. The exposed pad must be connected to the RF/dc ground of the PCB.

INTERFACE SCHEMATICS

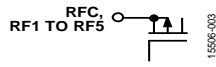

Figure 3. RF Pin Interface Schematic

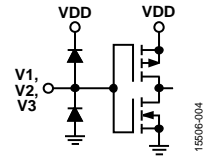

Figure 4. Digital Pin Interface Schematic

# TYPICAL PERFORMANCE CHARACTERISTICS

## INSERTION LOSS, RETURN LOSS, AND ISOLATION

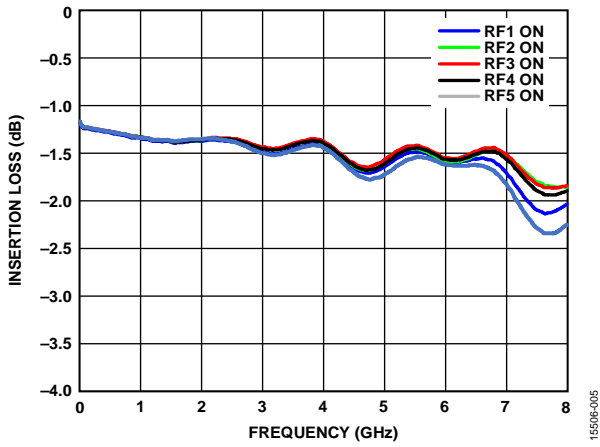

Figure 5. Insertion Loss on RF Paths at Room Temperature

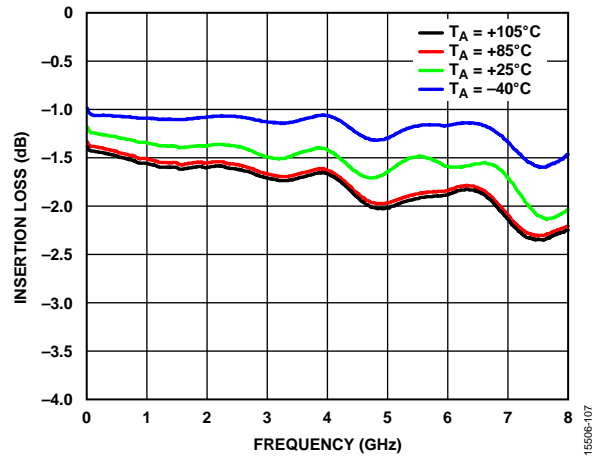

Figure 8. Insertion Loss on RF Paths over Temperature

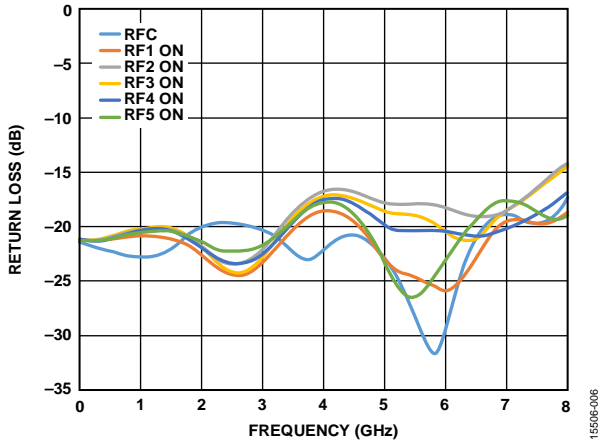

Figure 6. Return Loss on Selected RFx Ports and RFC

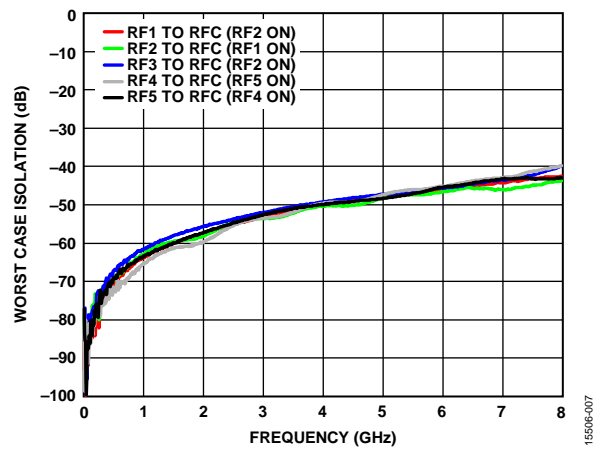

Figure 9. Worst Case Isolation on RF Paths

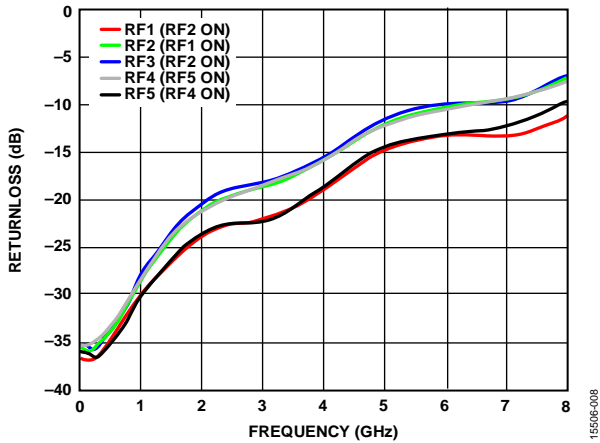

Figure 7. Return Loss on Terminated RFx Ports



INPUT POWER COMPRESSION AND THIRD-ORDER INTERCEPT (IP3)

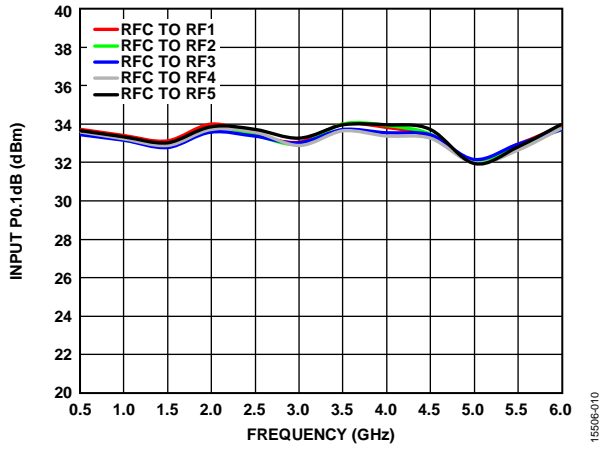

Figure 10. Input 0.1 dB Power Compression (P0.1dB) vs. Frequency, V<sub>DD</sub> = 3.3 V, V<sub>SS</sub> = 0 V

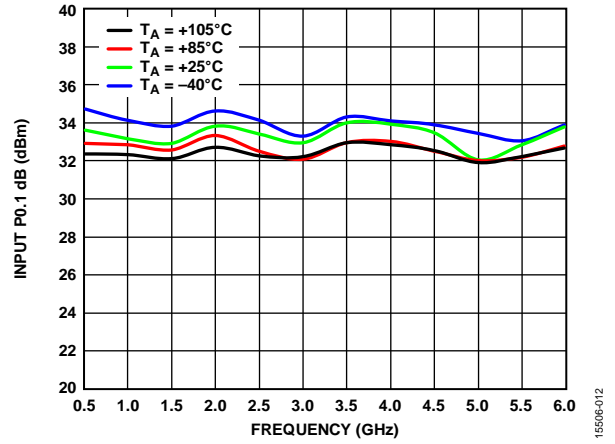

Figure 13. Input 0.1 dB Power Compression vs. Frequency over Temperature, V<sub>DD</sub> = 3.3 V, V<sub>SS</sub> = 0 V

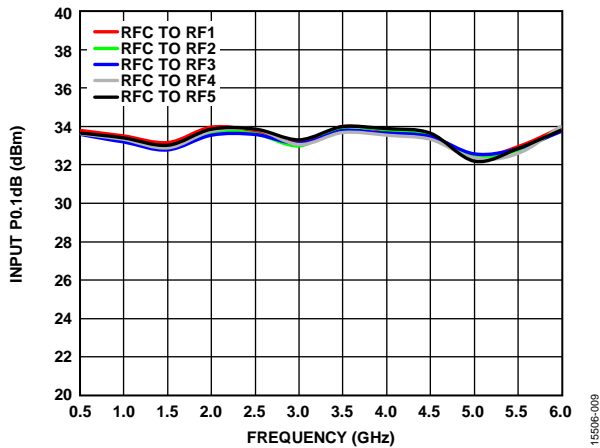

Figure 11. Input 0.1 dB Power Compression (P0.1dB) vs. Frequency, V<sub>DD</sub> = 5 V, V<sub>SS</sub> = 0 V

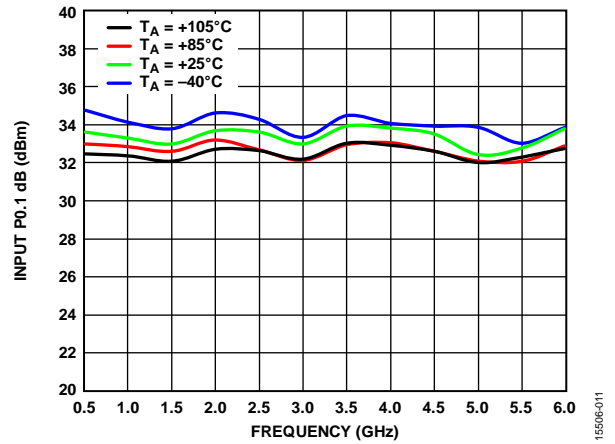

Figure 14. Input 0.1 dB Power Compression (P0.1dB) vs. Frequency over Temperature, V<sub>DD</sub> = 5 V, V<sub>SS</sub> = 0 V

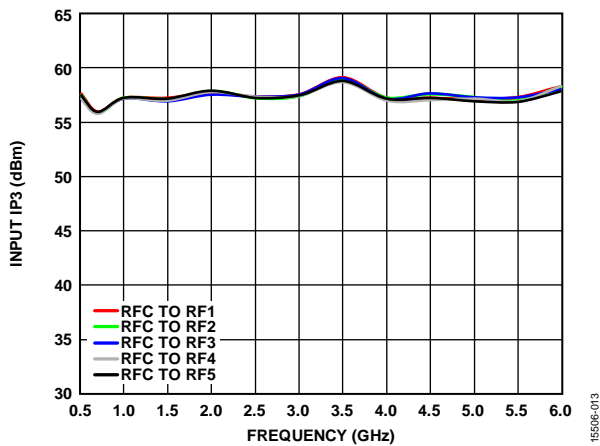

Figure 12. Input IP3 vs. Frequency, V<sub>DD</sub> = 5 V, V<sub>SS</sub> = 0 V

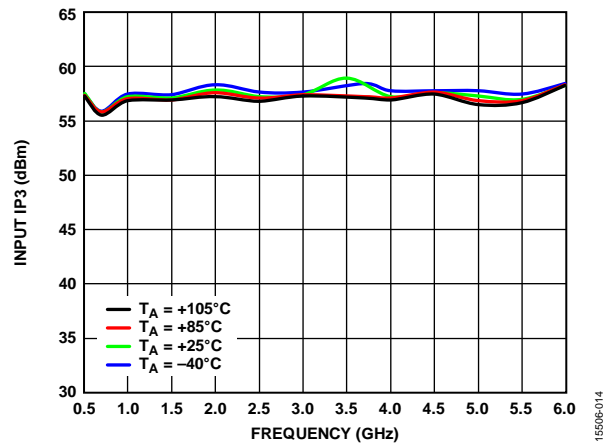

Figure 15. Input IP3 vs. Frequency over Temperature, V<sub>DD</sub> = 5 V, V<sub>SS</sub> = 0 V

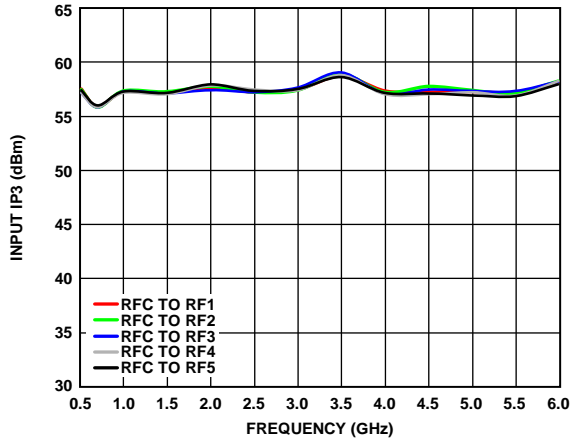

Figure 16. Input IP3 vs. Frequency,  $V_{DD} = 3.3\text{ V}$ ,  $V_{SS} = 0\text{ V}$

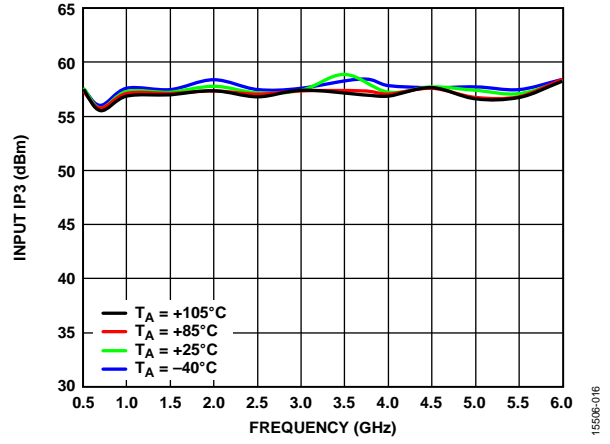

Figure 17. Input IP3 vs. Frequency over Temperature,  $V_{DD} = 3.3\text{ V}$ ,  $V_{SS} = 0\text{ V}$

## THEORY OF OPERATION

The ADRF5250 requires a positive supply voltage applied to the VDD pin and 0 V or  $-3.3$  V supply voltage applied to the VSS pin. Bypass capacitors are recommended on the supply and digital control lines to minimize RF coupling. An incorporated negative supply generator is enabled or disabled depending on the applied  $V_{SS}$  supply voltage. Table 4 describes the operation mode of that negative supply generator.

**Table 4. Negative Voltage Generator Operation Mode**

$V_{SS}$	Test Conditions/Comments
0 V	The incorporated negative voltage generator is enabled
$-3.3$ V	The incorporated negative voltage generator is disabled

The ADRF5250 is internally matched to  $50\ \Omega$  at the RF common port (RFC) and the RF throw ports (RF1 to RF5); therefore, no external matching components are required. All of the RF ports are dc-coupled to 0 V, and no dc blocking is required at the RF ports when the RF line potential is equal to 0 V. The design is bidirectional; the RF input signal can be applied to the RFC port while the RF throw port (RF1 to RF5) is output, or vice versa.

The ADRF5250 has a 3-bit, 1.8 V logic-compatible control interface that is controlled through the V1, V2, and V3 digital control voltage pins. A small bypassing capacitor is recommended on these digital signal lines to improve the RF signal isolation. The V1 and V3 test points correspond to the LSB and MSB of the digital control interface of the ADRF5250. The modes of the RF paths are determined as shown in Table 5.

When an RF path is on, the RF signal is conducted equally well in both directions between its throw port (RFx) and common port (RFC). Otherwise, each RFx path is terminated to an internal  $50\ \Omega$  resistor that provides high loss between the insertion loss path and its throw ports.

**Table 5. Control Voltage Truth Table**

$V_3$	$V_2$	$V_1$	Mode
Low	Low	Low	All Off
Low	Low	High	RF1 on
Low	High	Low	RF2 on
Low	High	High	RF3 on
High	Low	Low	RF4 on
High	Low	High	RF5 on
High	High	Low	All off
High	High	High	All off

The ideal power-up sequence is as follows:

1. Power up GND.
2. Power up VDD and VSS. The relative order is not important.
3. Power up the digital control inputs. The relative order of the logic control inputs is not important. However, powering the digital control inputs before the VDD supply can inadvertently forward bias and damage the internal ESD protection structures.
4. Apply an RF input signal.

## APPLICATIONS INFORMATION

### EVALUATION BOARD

Figure 18 and Figure 19 show the top and cross sectional views of the evaluation board, which uses 4-layer construction with a copper thickness of 0.5 oz (0.7 mil) and dielectric materials between each copper layer.

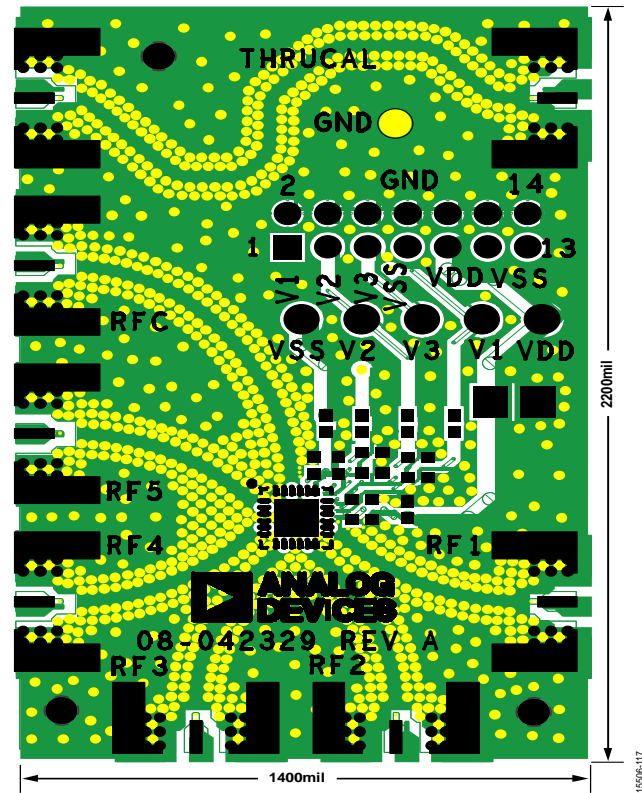

Figure 18. Evaluation Board Layout Top View



Figure 19. Evaluation Board Cross Sectional View

All RF traces are routed on Layer 2; the V1, V3, and VSS dc traces are routed on Layer 3; the V2 and VDD dc traces are routed on the top layer; and the other remaining layers are grounded planes that provide a solid ground for RF transmission lines. The top and bottom dielectric material are Rogers 4350B, offering low loss performance. The middle dielectric material is Rogers 4450F and is used to achieve an overall board thickness of 30 mil. The RF transmission lines were designed using a

coplanar waveguide (CPWG) model with a width of 8 mil and ground spacing of 10 mil for a characteristic impedance of 50 Ω. For optimal RF and thermal grounding, as many plated through vias as possible are arranged around the transmission lines and under the exposed pad of the package.

Figure 20 shows the actual ADRF5250 evaluation board with component placement. Two power supply ports are connected to the VDD and VSS test points, TP3 and TP5, and the ground reference is connected to the GND test point, TP6. On the digital control and VDD supply traces, bypass capacitors are used.

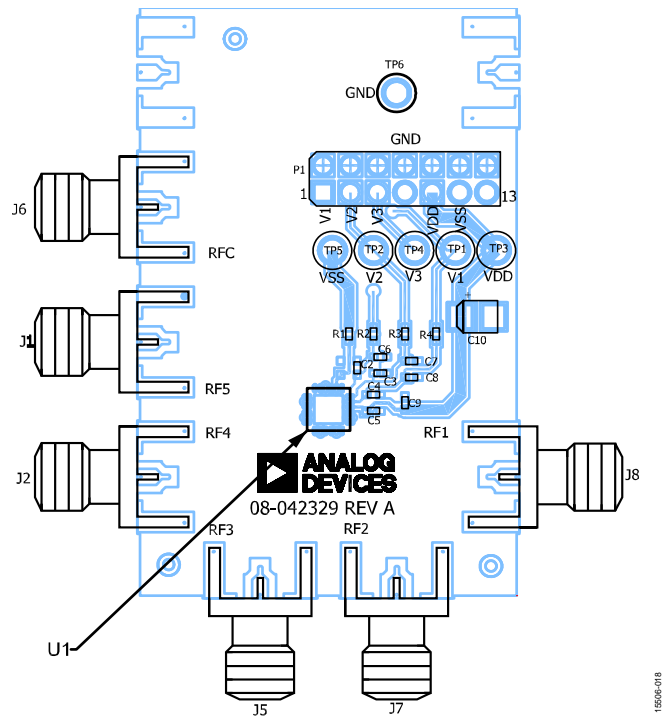

Figure 20. ADRF5250-EVALZ Evaluation Board

Three control ports are connected to the V1, V2, and V3 test points, TP1, TP2, and TP4, respectively. On each control trace, a resistor position is available to improve the isolation between the RF and control signals. The RF ports are connected to the RFC, RF1, RF2, RF3, RF4, and RF5 connectors (J6, J8, J7, J5, J2, and J1), which are end launch jack SMA RF connectors. A through transmission line that connects unpopulated RF connectors (J3 and J4) is also available to measure the loss of the PCB. Figure 22 and Table 6 show the evaluation board schematic and bill of materials, respectively.

The evaluation board shown in Figure 20 is available for order from the Analog Devices, Inc., website at [www.analog.com](http://www.analog.com).

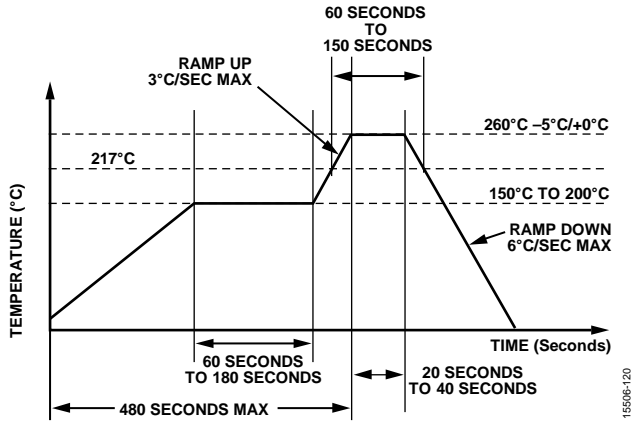

Figure 21. Pb-Free Reflow Solder Profile

Table 6. Bill of Materials for the ADRF5250-EVALZ Evaluation Board

Item	Description
J1, J2, J5 to J8	RF SMA connectors
TP1 to TP6	DC bias test pins
C2 to C5	100 pF capacitors, 0402 package
C6 to C9	0.01 μF capacitor, 0402 package
C10	10 μF capacitor, tantalum package
08-042239	Evaluation PCB, Rogers 4350B circuit board material

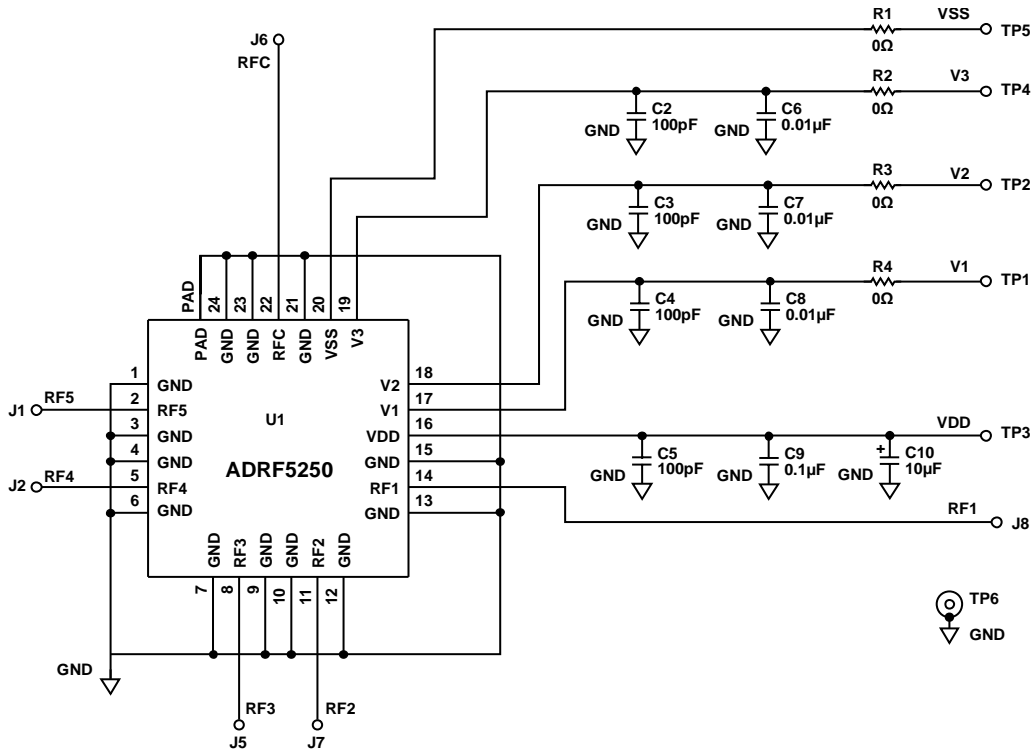

Figure 22. ADRF5250-EVALZ Evaluation Board Schematic



**NOTES**