

HSMC SATA RAID board [AB12-HSMCRAID]

Manual [Ver1.0E]

Introduction

Thank you for choosing HSMC SATA RAID board [Part Number: AB12-HSMCRAID] (“RAID board” in this manual.)
 The RAID board is compliant with HSMC standard of Altera and provides 8 SATA channels at maximum by high speed serial interface in HSMC so that user can build SATA RAID prototype system.
 The RAID board can directly connect with 8 pcs of 2.5”-SATA drive. User can supply power to the connected SATA drive via 4-pin ATX Standard power connector.
 On-board 150MHz low-jitter differential oscillator will supply high-quality reference SATA clock to the refclk input of FPGA via HSMC I/F (CLKIN2p/n).

Board Appearance

The RAID board size is 78mm width and 90mm length.
 Following figure-1 and figure-2 shows component side and solder side appearance respectively.

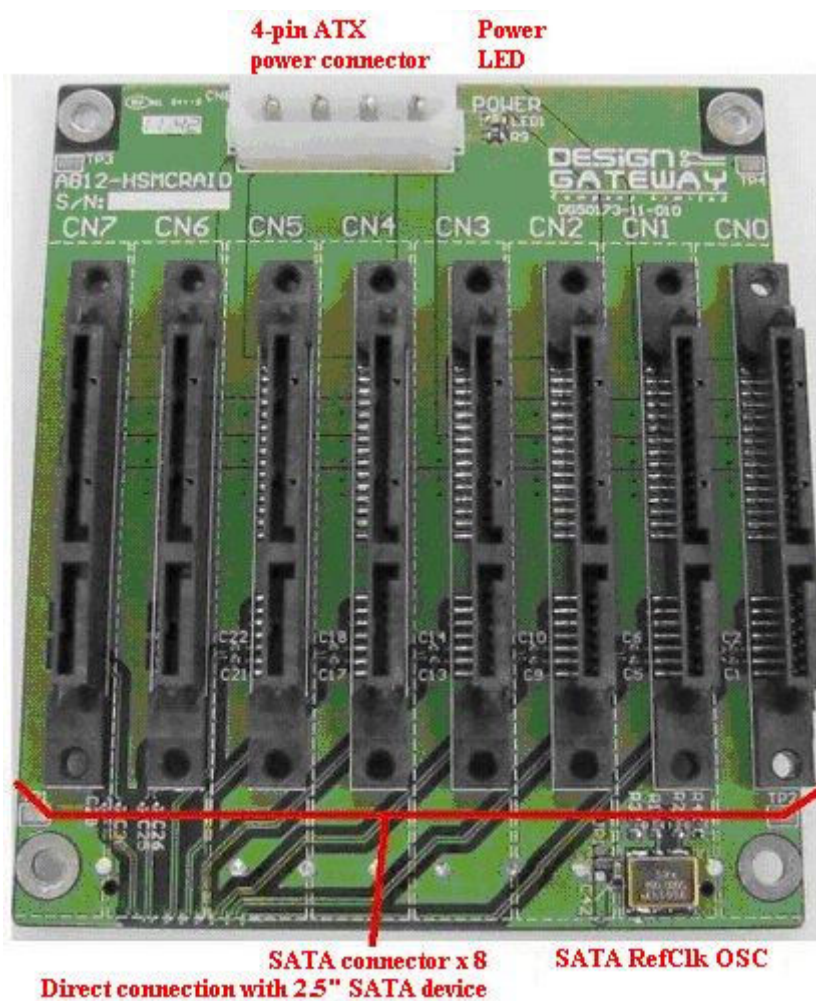

Figure-1: AB12-HSMCRAID component side

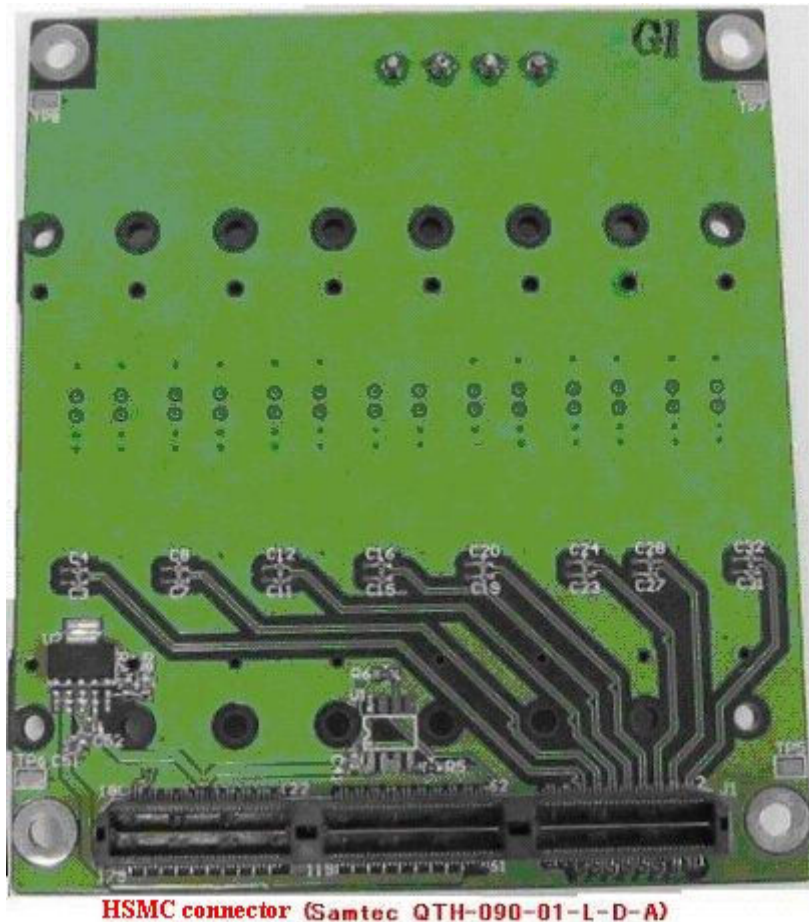

Figure-2: AB12-HSMCRAID solder side

Connection to the FPGA board

Connect the RAID board with HSMC connector on the FPGA board.

For 2.5"-SATA drive connection, user can directly connect SATA drive with CN0 – CN7 SATA connector on the RAID board.

Use 4-pin ATX Standard power connector for SATA drive power supply.

User must check that all SATA drives, RAID board and FPGA board are powered off when remove or connect.

To connect 3.5"-SATA drive, use SATA general extension cable. Following general extension cable is suitable for 3.5" usage.

Vendor: AREA (Setagaya Denki)

Product Number: AR-S005S

URL : <http://www.area-powers.jp/denki/cable/s005s.htm>

Vendor: AINEX

Product Number: SAT-15EXPA

URL : <http://www.ainex.jp/products/sat-15expa.htm>

When user want to assign SATA channel of the RAID board as a SATA Device to connect with SATA Host-PC, use above extension cable along with the following crossover adapter provided from DesignGateway.

Vendor: DesignGateway

Product Number: AB02-CROSSOVER

URL : <http://www.design-gateway.com/ABseries.html>

Pin Assignment

Pin assignment of HSMC on the RAID board is listed following table-1.

HSMC Pin# (*1)	Samtec Pin# (*1)	HSMC definition	Signal Name	RAID Bd connection destination
1	1	TX_P7	HT7P	CN7-S2 (TX Pos)
2	2	RX_P7	HR7P	CN7-S6 (RX Pos)
3	3	TX_N7	HT7N	CN7-S3 (TX Neg)
4	4	RX_N7	HR7N	CN7-S5 (RX Neg)
5	7	TX_P6	HT6P	CN6-S2 (TX Pos)
6	8	RX_P6	HR6P	CN6-S6 (RX Pos)
7	9	TX_N6	HT6N	CN6-S3 (TX Neg)
8	10	RX_N6	HR6N	CN6-S5 (RX Neg)
9	13	TX_P5	HT5P	CN5-S2 (TX Pos)
10	14	RX_P5	HR5P	CN5-S6 (RX Pos)
11	15	TX_N5	HT5N	CN5-S3 (TX Neg)
12	16	RX_N5	HR5N	CN5-S5 (RX Neg)
13	19	TX_P4	HT4P	CN4-S2 (TX Pos)
14	20	RX_P4	HR4P	CN4-S6 (RX Pos)
15	21	TX_N4	HT4N	CN4-S3 (TX Neg)
16	22	RX_N4	HR4N	CN4-S5 (RX Neg)
17	25	TX_P3	HT3P	CN3-S2 (TX Pos)
18	26	RX_P3	HR3P	CN3-S6 (RX Pos)
19	27	TX_N3	HT3N	CN3-S3 (TX Neg)
20	28	RX_N3	HR3N	CN3-S5 (RX Neg)
21	31	TX_P2	HT2P	CN2-S2 (TX Pos)
22	32	RX_P2	HR2P	CN2-S6 (RX Pos)
23	33	TX_N2	HT2N	CN2-S3 (TX Neg)
24	34	RX_N2	HR2N	CN2-S5 (RX Neg)
25	37	TX_P1	HT1P	CN1-S2 (TX Pos)
26	38	RX_P1	HR1P	CN1-S6 (RX Pos)
27	39	TX_N1	HT1N	CN1-S3 (TX Neg)
28	40	RX_N1	HR1N	CN1-S5 (RX Neg)
29	43	TX_P0	HT0P	CN0-S2 (TX Pos)
30	44	RX_P0	HR0P	CN0-S6 (RX Pos)
31	45	TX_N0	HT0N	CN0-S3 (TX Neg)
32	46	RX_N0	HR0N	CN0-S5 (RX Neg)
156	176	CLKIN2P	SCKN	(via R1) X1-5 (*2)
158	178	CLKIN2N	SCKP	(via R2) X1-4 (*2)

Table1: HSMC pin assignment of AB12-HSMCRAID board

Note:

(*1) HSMC Pin# is pin number defined in HSMC standard, while Samtec Pin# is pin number of connector specification.

(*2) 150MHz SATA reference clock of CLKIN2P/N is reversed in its polarity due to the board trace, however, this polarity inversion is no problem because differential clock waveform is symmetrical.



Disclaimer

DesignGateway is exempted from any damage to the connected SATA device or FPGA board.
DesignGateway does not guarantee transfer speed performance.

[Inquiry]

URL : <http://www.design-gateway.com/>

Email : <mailto:sales@design-gateway.com>

Revision History

Revision	Date	Description
1.0E	13-Jul-2012	Release English manual

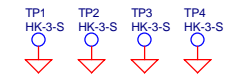
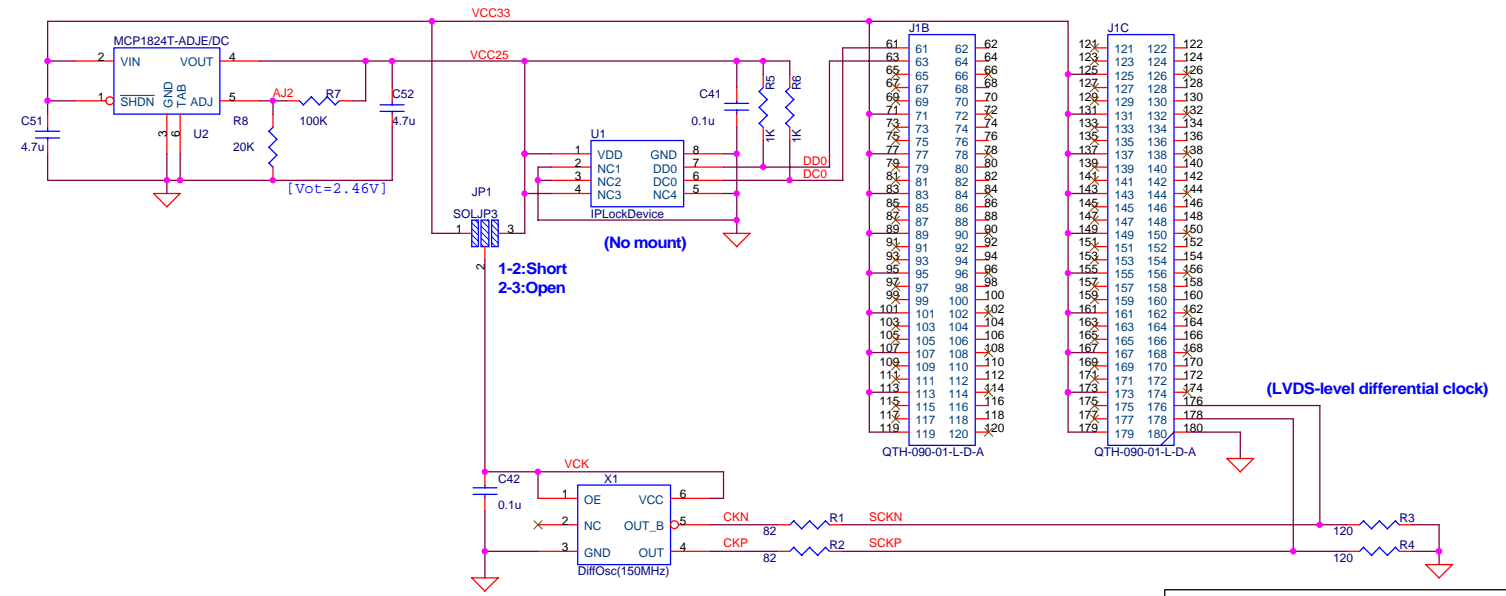
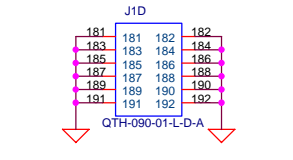
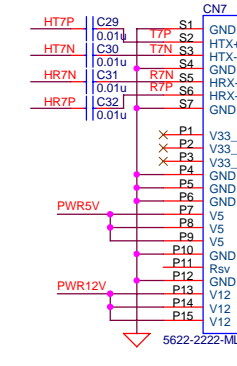
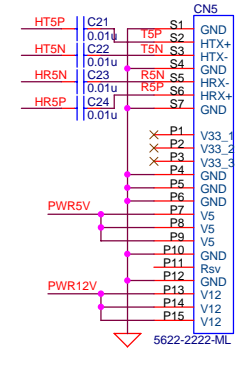
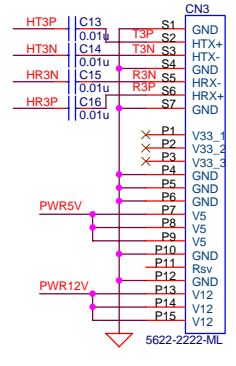
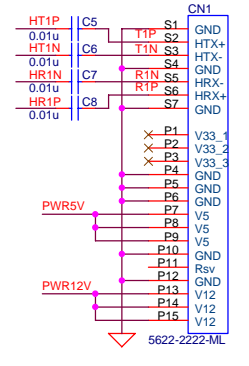
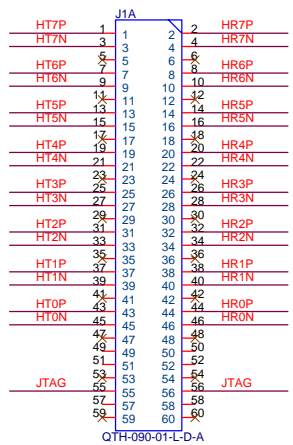
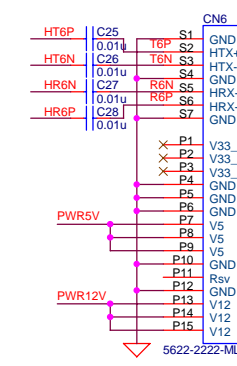
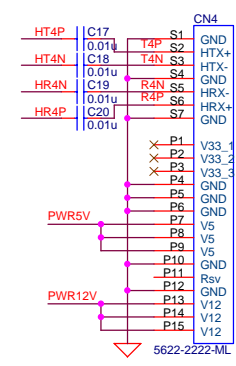
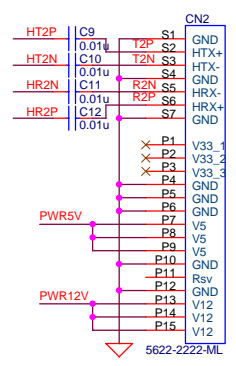
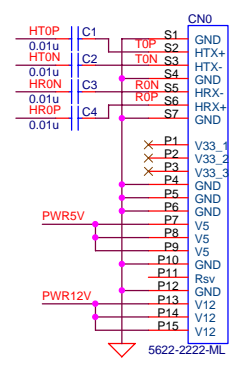
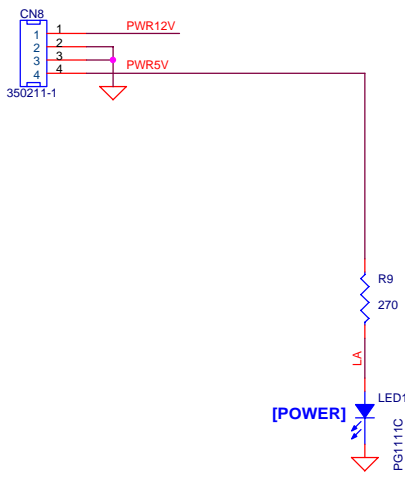

Component side GND test pin

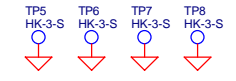

Solder side GND test pin

Title			RAID
Size	Document Number	Rev	
A3	AB12-HSMCRAID	1.0	
Date:	Friday, January 13, 2012	Sheet	1 of 1