

Button G click

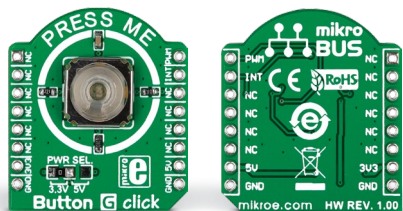

1. Introduction

Button G click is the simplest solution for adding a single pushbutton to your design. The button itself is transparent, 6.8mm in diameter and has a green LED backlight. When pressed, it sends an interrupt signal to the target board microcontroller, while the LED is controlled separately through the mikroBUS™ PWM pin. Button G click can use either a 3.3V or a 5V power supply.

2. Soldering the headers

Before using your click board™, make sure to solder 1x8 male headers to both left and right side of the board. Two 1x8 male headers are included with the board in the package.

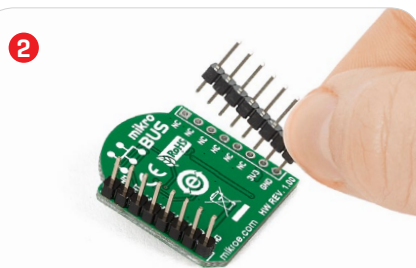
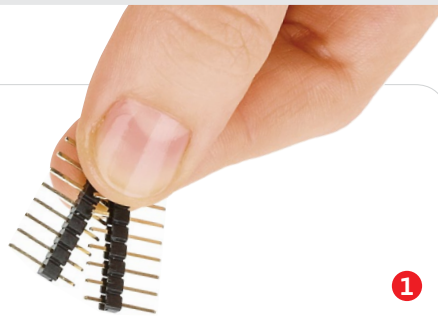

Turn the board upside down so that the bottom side is facing you upwards. Place shorter pins of the header into the appropriate soldering pads.

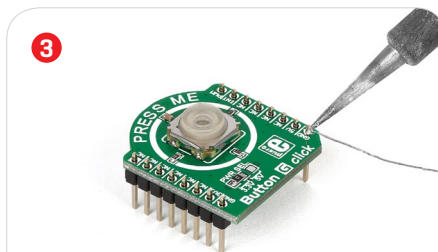

Turn the board upward again. Make sure to align the headers so that they are perpendicular to the board, then solder the pins carefully.

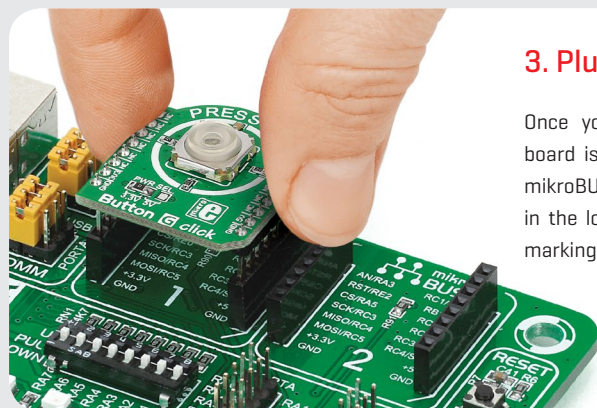

3. Plugging the board in

Once you have soldered the headers your board is ready to be placed into the desired mikroBUS™ socket. Make sure to align the cut in the lower-right part of the board with the markings on the silkscreen at the mikroBUS™ socket. If all the pins are aligned correctly, push the board all the way into the socket.

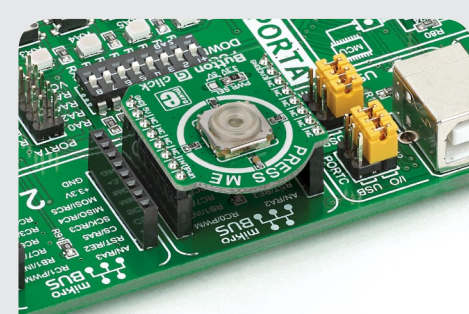

4. Essential features

The tactile feel from a pushbutton cannot be easily substituted by onscreen user interfaces. Multitouch gestures, swipes, taps and double taps have their place, but if you need a reliable way to control an important switch, and a way of always knowing whether contact has been made, hardware pushbuttons are irreplaceable. It doesn't have to be an on/off switch either. Since the backlight LED is controlled independently, you can program different patterns [varying level of light intensity or rate of blinking on subsequent button presses], giving additional feedback to the end-user.

click
BOARDS™
www.mikroe.com



Button G click Manual v100



5. Schematic

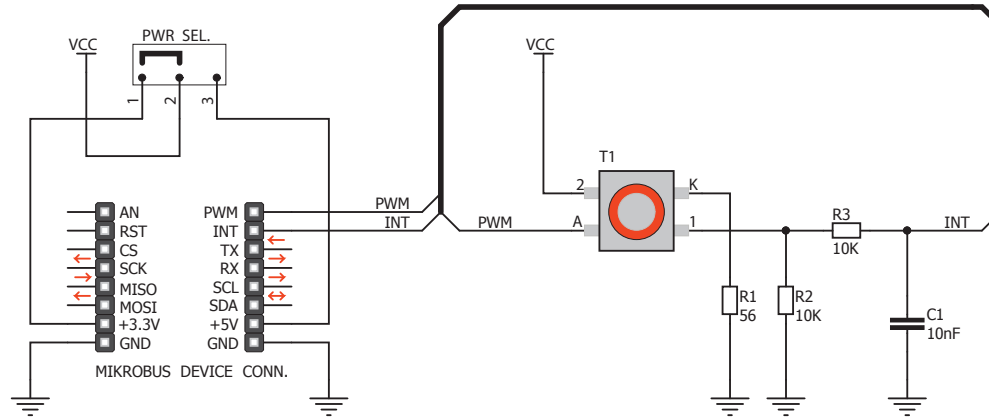

6. Dimensions

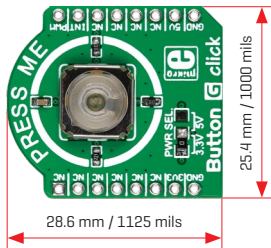

	mm	mils
LENGTH	28.6	1125
WIDTH	25.4	1000
HEIGHT*	5.7	225

* without headers

7. SMD jumper

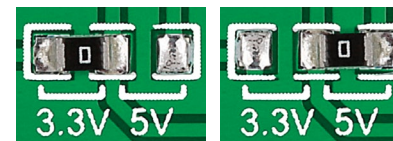

Button G click has a PWR SEL jumper [zero ohm resistor] that lets you switch between 3.3V and 5V power supplies.

8. Code examples

Once you have done all the necessary preparations, it's time to get your click board™ up and running. We have provided examples for mikroC™, mikroBasic™ and mikroPascal™ compilers on our **Libstock** website. Just download them and you are ready to start.



9. Support

MikroElektronika offers **free tech support** [www.mikroe.com/support] until the end of the product's lifetime, so if something goes wrong, we're ready and willing to help!



10. Disclaimer

MikroElektronika assumes no responsibility or liability for any errors or inaccuracies that may appear in the present document. Specification and information contained in the present schematic are subject to change at any time without notice.

Copyright © 2015 MikroElektronika.
All rights reserved.