

DUAL AUDIO OPERATIONAL AMPLIFIER

■ GENERAL DESCRIPTION

The NJM8080 is dual operational amplifier designed for audio applications. NJM8080 finely refines to every detail from Si-wafer to circuit layout, stick in a thorough improvement in sound quality. The NJM8080 features high resolution and crispy-clear high frequency sound, which can fully perform the digital sound source with loss-less.

NJM8080 features low noise, wide gain-bandwidth, low distortion and high output current, and various reliabilities and conveniences are improved. NJM8080 can widely be used as the standard audio operational amplifier.

■ FEATURES

- Operating Voltage $\pm 2V$ to $\pm 18V$
 - Low Input Noise Voltage $5nV/\sqrt{\text{Hz}}$ typ. at $f=1\text{kHz}$
 - Wide Gain Bandwidth Product 15MHz typ.
 - Low Distortion 0.0005% typ.
 - Slew Rate $5V/\mu\text{s}$ typ.
 - Bipolar Technology
 - Package Outline
- SOP8,
MSOP8 (TVSP8)*
*MEET JEDEC MO-187-DA/ THIN TYPE
SSOP8
- Internal ESD protection
Human body model (HBM) $\pm 2000V$ typ.
 - Wide temperature range -40°C to $+125^\circ\text{C}$

■ PACKAGE OUTLINE



■ PIN CONFIGURATION

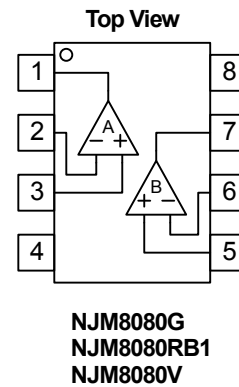

- PIN FUNCTION**
- 1.A OUTPUT
 - 2.A -INPUT
 - 3.A +INPUT
 - 4.V⁻
 - 5.B +INPUT
 - 6.B -INPUT
 - 7.B OUTPUT
 - 8.V⁺

■ EQUIVALENT CIRCUIT (1/2 Shown)

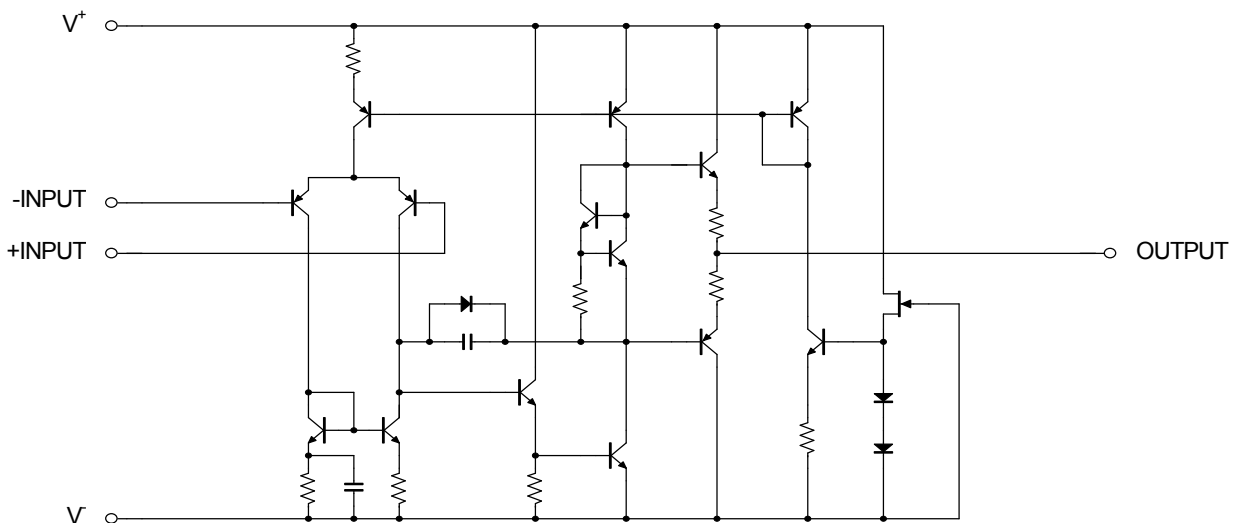

NJM8080

■ ABSOLUTE MAXIMUM RATINGS (Ta=25°C, unless otherwise noted.)

PARAMETER	SYMBOL	RATING	UNIT
Supply Voltage	V ⁺ /V	±18V	V
Differential Input Voltage (Note1)	V _{ID}	±36	V
Input Voltage (Note2)	V _{IN}	V-0.3 to V+36	V
Output Terminal Input Voltage	V _O	V-0.3 to V ⁺ +0.3	V
Power Dissipation	P _D	SOP : 690 (Note3) 1000 (Note4) MSOP : 510 (Note3) 680 (Note4) SSOP : 430 (Note3) 540 (Note4)	mW
Operating Temperature Range	T _{opr}	-40~+125	°C
Storage Temperature Range	T _{stg}	-65~+150	°C

(Note1) Differential voltage is the voltage difference between +INPUT and -INPUT.

(Note2) Input voltage is the voltage should be allowed to apply to the input terminal independent of the magnitude of V⁺.

The normal operation will establish when any input is within the Common Mode Input Voltage Range of electrical characteristics.

(Note3) EIA/JEDEC STANDARD Test board (76.2 x 114.3 x 1.6mm, 2layers, FR-4) mounting

(Note4) EIA/JEDEC STANDARD Test board (76.2 x 114.3 x 1.6mm, 4layers, FR-4) mounting

■ RECOMMENDED OPERATING CONDITIONS (Ta=25°C)

PARAMETER	SYMBOL	CONDITION	MIN.	TYP.	MAX.	UNIT
Supply Voltage	V ⁺ /V		±2	-	±18	V

■ ELECTRICAL CHARACTERISTICS (V⁺/V=±15V, Ta=25°C, unless otherwise noted.)

PARAMETER	SYMBOL	TEST CONDITION	MIN.	TYP.	MAX.	UNIT
Input Offset Voltage	V _{IO}	R _S ≤10kΩ	-	0.3	3	mV
Input Offset Current	I _{IO}		-	5	200	nA
Input Bias Current	I _B		-	100	500	nA
Input Resistance	R _{IN}		-	0.5	-	MΩ
Large Signal Voltage Gain	A _V	R _L ≥2kΩ, V _O =±10V	90	110	-	dB
Maximum Output Voltage	V _{OM}	R _L ≥2kΩ	±12	±13.5	-	V
Common Mode Input Voltage Range	V _{ICM}		±12	±13.5	-	V
Common Mode Rejection Ratio	CMR	R _S ≤10kΩ	80	110	-	dB
Supply Voltage Rejection Ratio	SVR	R _S ≤10kΩ	80	110	-	dB
Supply Current	I _{CC}		-	6	9	mA
Slew Rate	SR	R _L ≥2kΩ	-	5	-	V/μs
Gain Bandwidth Product	GBP	f=10kHz	-	15	-	MHz
Total Harmonic Distortion	THD	A _V =20dB, V _O =5V, R _L =2kΩ, f=1kHz	-	0.0005	-	%
Equivalent Input Noise Voltage ¹	e _n	f=1kHz	-	5	-	nV/√Hz

■ TYPICAL CHARACTERISTICS

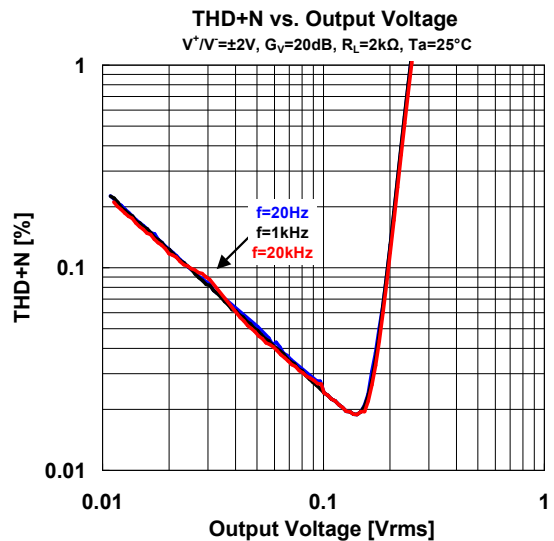
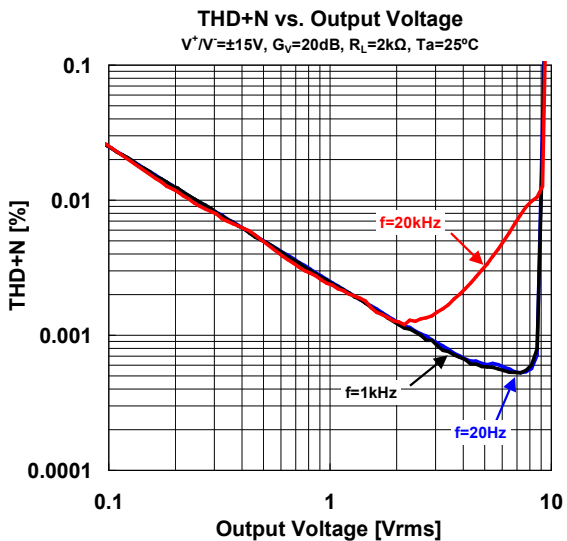
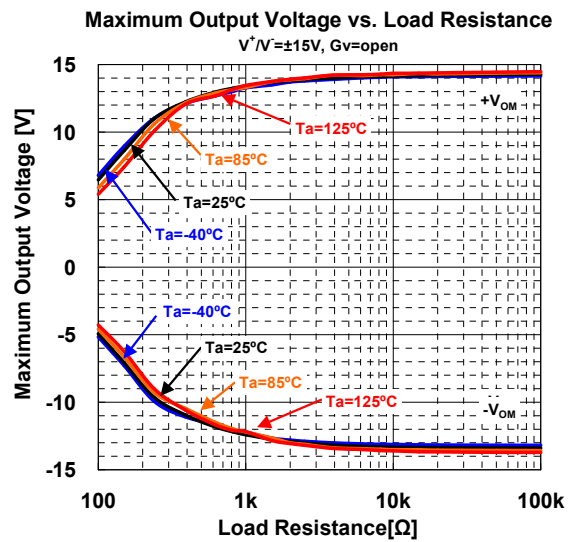
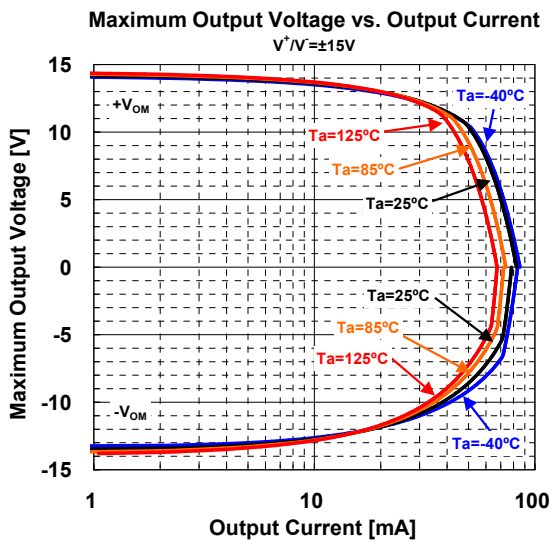
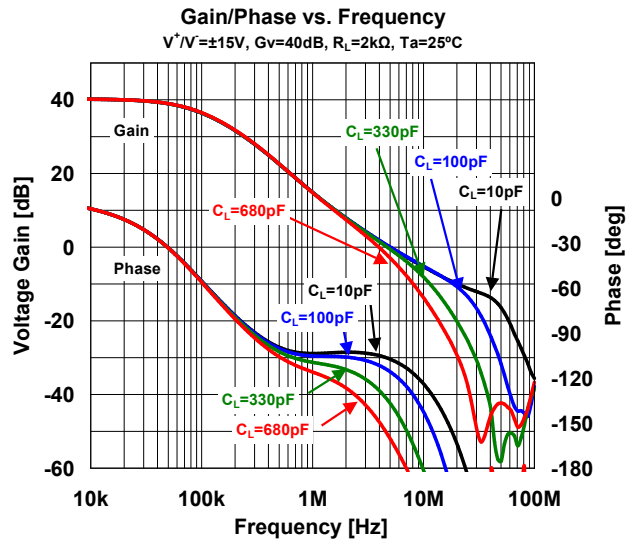
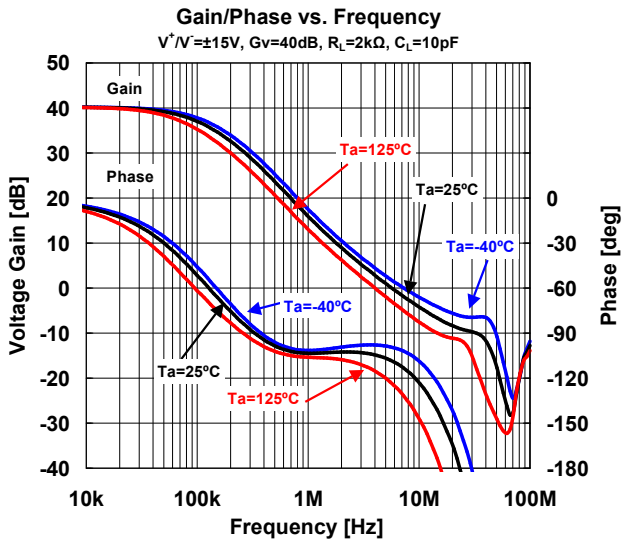

TYPICAL CHARACTERISTICS

Maximum Output Voltage Swing vs. Frequency
 $V^+/V^- = \pm 15V$, $R_L = 2k\Omega$, $T_a = 25^\circ C$

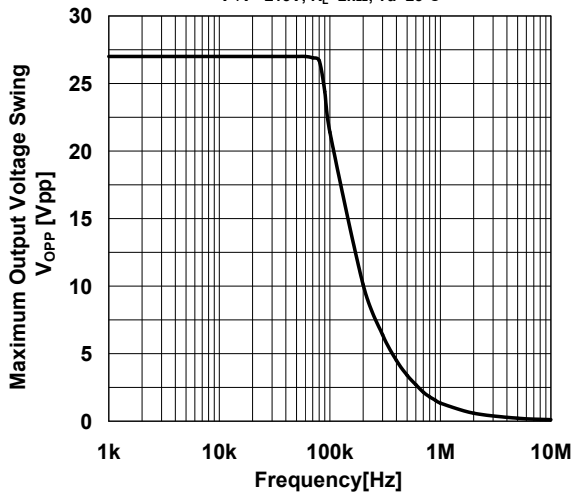

Voltage Noise vs. Frequency
 $V^+/V^- = \pm 15V$, $G_v = 40dB$, $R_F = 2k\Omega$, $T_a = 25^\circ C$

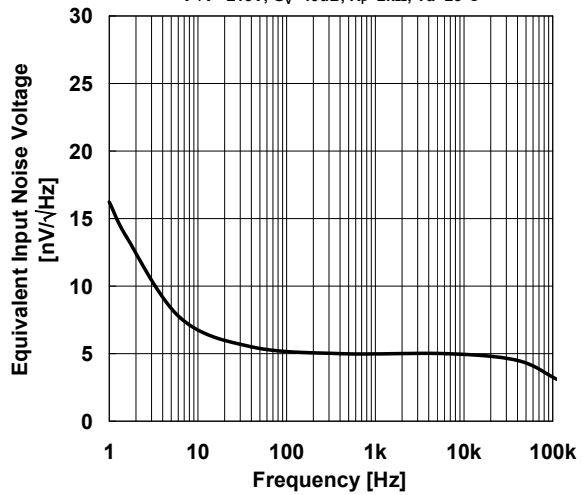

Supply Current vs. Supply Voltage
 $R_L = \text{open}$

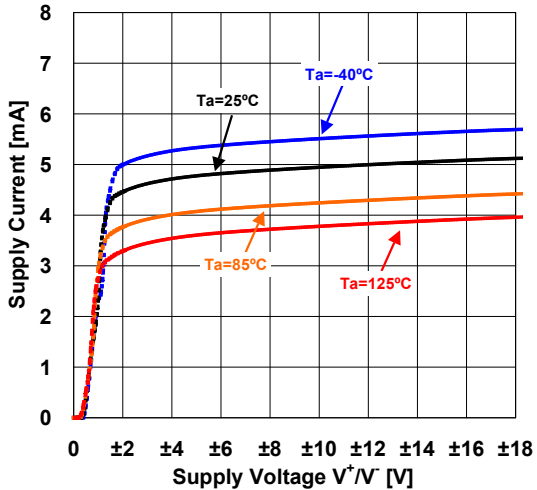

Supply Current vs. Temperature
 $R_L = \text{open}$

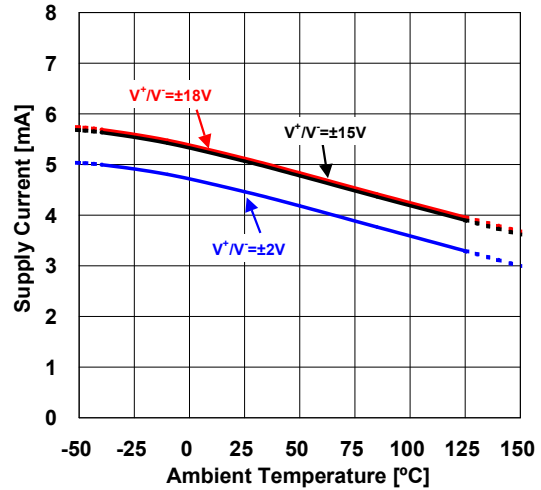

Input Offset Voltage vs. Temperature

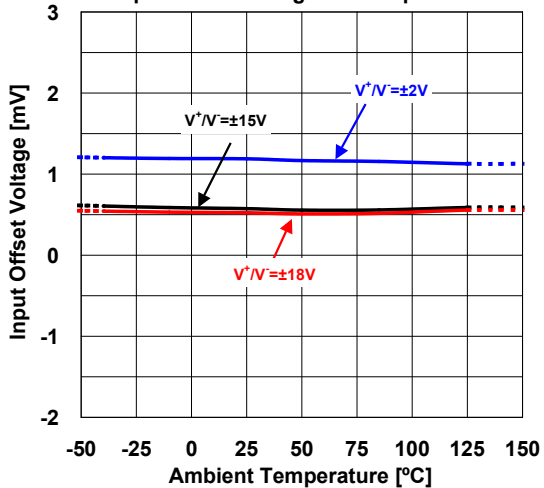

Input Offset Voltage vs. Supply Voltage

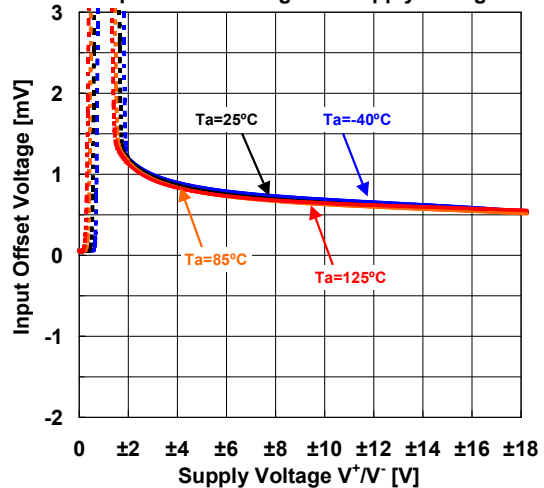

■ TYPICAL CHARACTERISTICS

Input Offset Voltage vs. Common-Mode Input Voltage
 $V^+/V^-=\pm 15V$

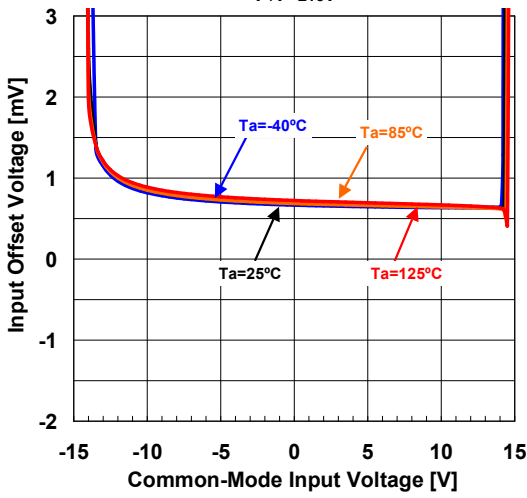

Input Offset Voltage vs. Common-Mode Input Voltage
 $V^+/V^-=\pm 2V$

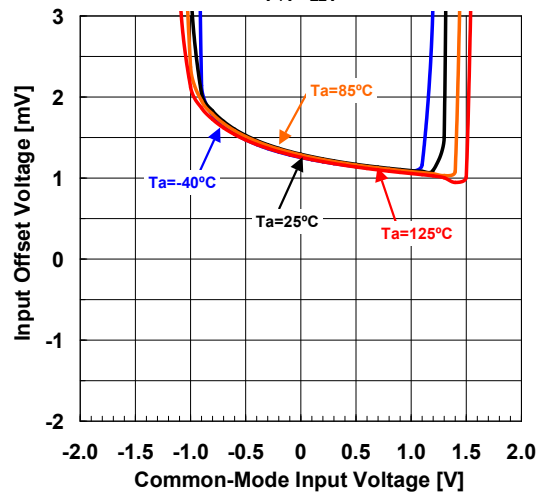

Input Bias Current vs. Temperature
 $V_{ICM}=0V$

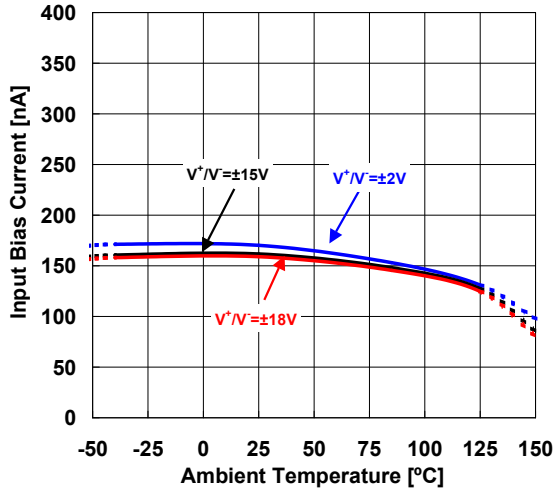

Voltage Gain vs. Temperature
 $V^+/V^-=\pm 15V, R_i=2k\Omega$ to GND

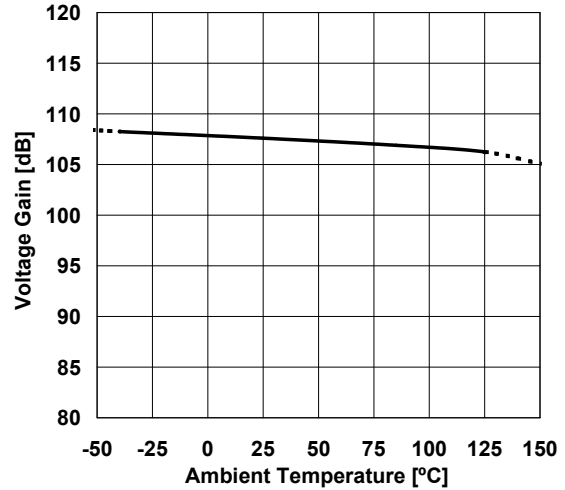

CMR vs. Temperature
 $V^+/V^-=\pm 15V, V_{CM}=-12.2V\sim 12.2V$

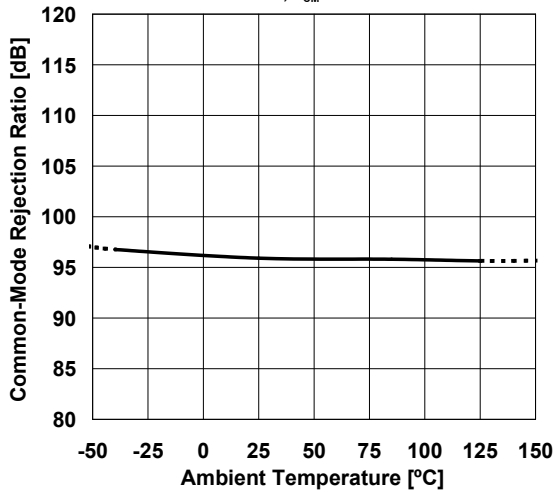

SVR vs. Temperature
 $V^+/V^-=\pm 9V \rightarrow \pm 18V$

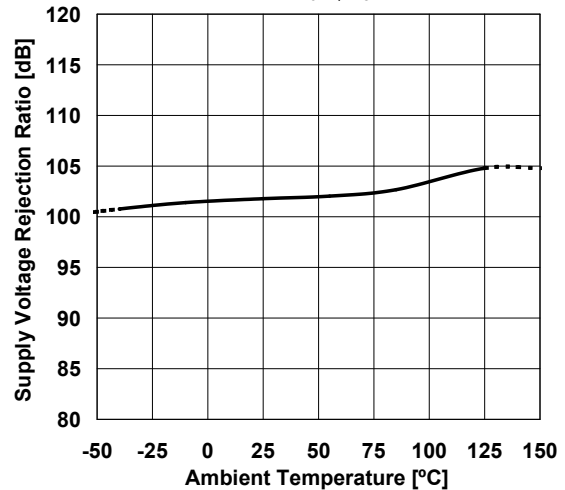

■ TYPICAL CHARACTERISTICS

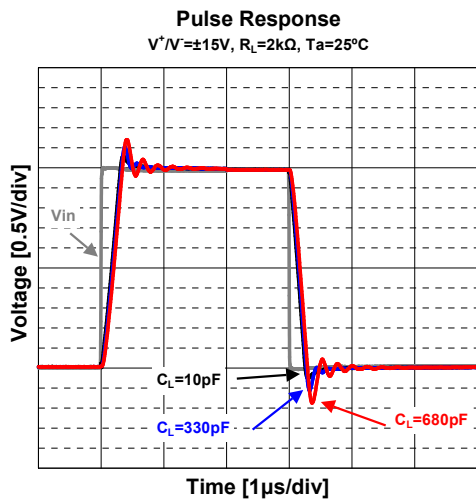
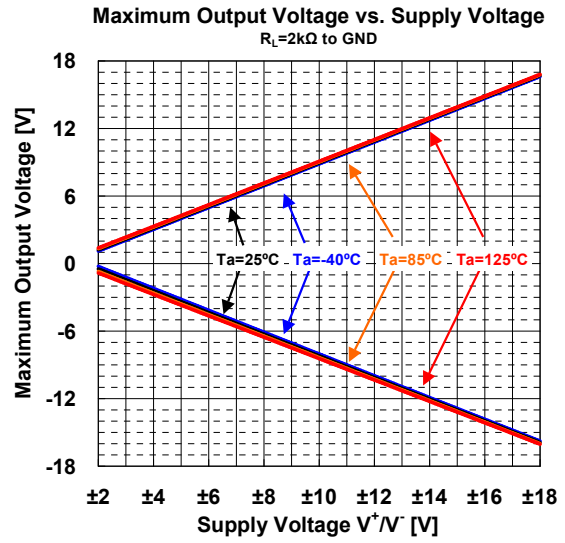
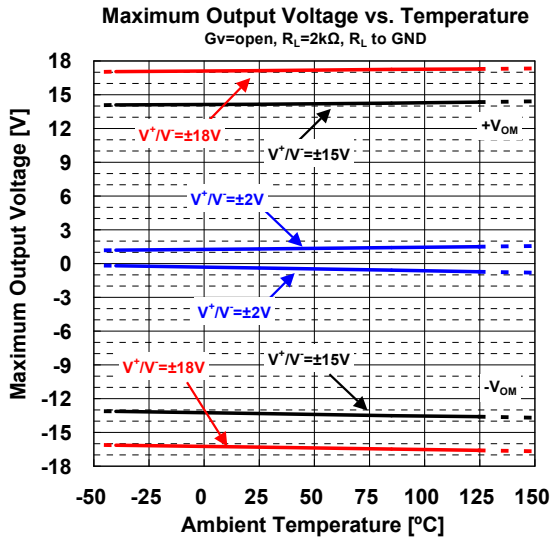

■PACKAGE OUTLINE UNIT : mm

SOP8

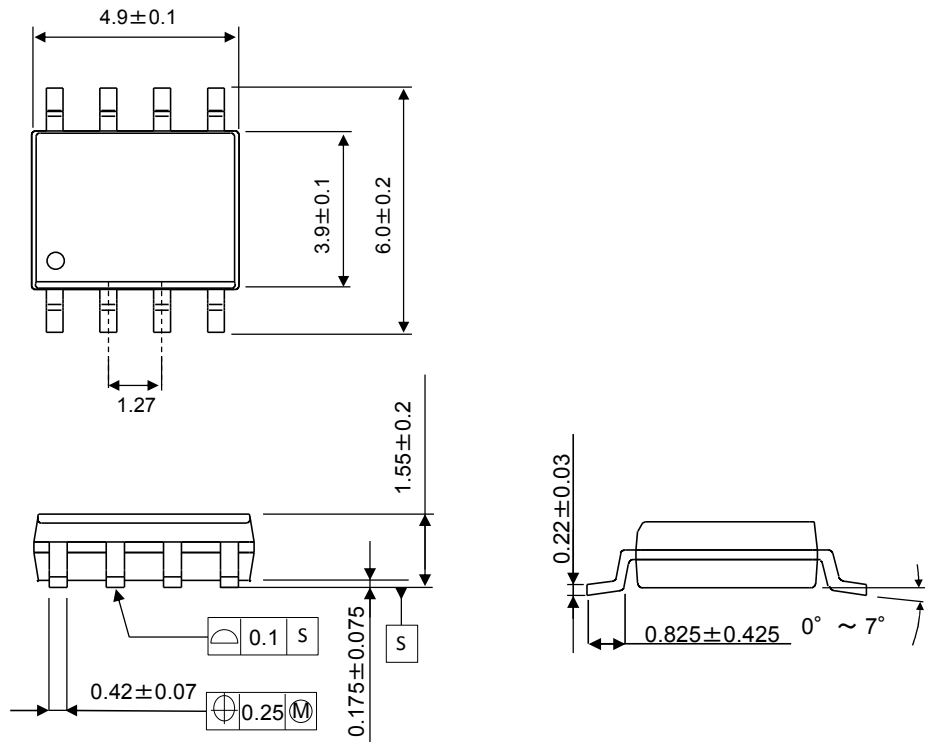

MSOP8 (TVSP8)*

*MEET JEDEC MO-187-DA/ THIN TYPE

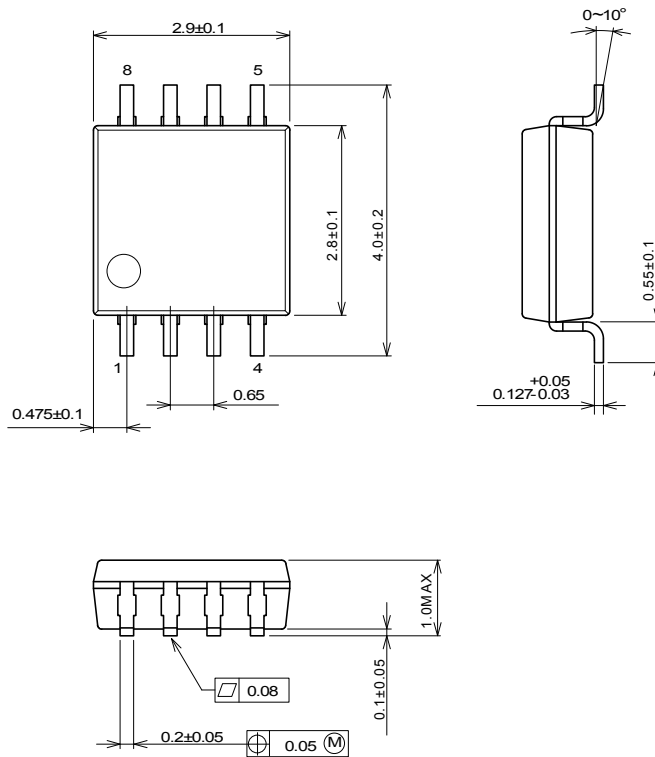

NJM8080

SSOP8

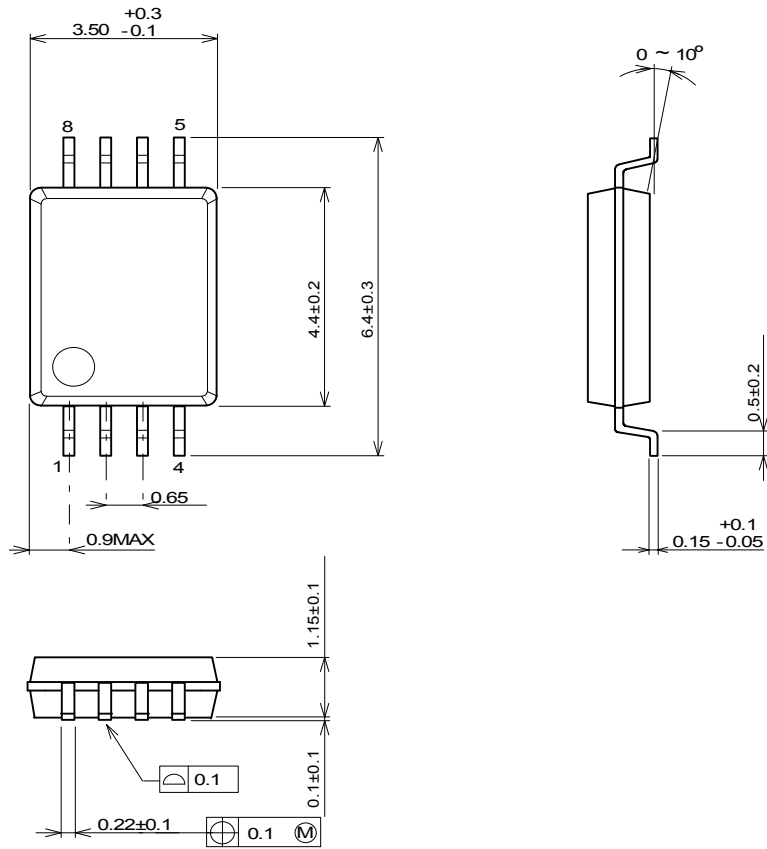

[CAUTION]
The specifications on this databook are only given for information, without any guarantee as regards either mistakes or omissions. The application circuits in this databook are described only to show representative usages of the product and not intended for the guarantee or permission of any right including the industrial rights.

Mouser Electronics

Authorized Distributor

Click to View Pricing, Inventory, Delivery & Lifecycle Information:

[NJR:](#)

[NJM8080G-TE2](#)