

EVALUATION KIT
AVAILABLE

Ultra-Precision, High-Side Current-Sense Amplifiers

MAX9922/MAX9923

General Description

The MAX9922/MAX9923 ultra-precision, high-side current-sense amplifiers feature ultra-low offset voltage (V_{OS}) of $25\mu\text{V}$ (max) and laser-trimmed gain accuracy better than 0.5%. The combination of low V_{OS} and high-gain accuracy allows precise current measurements even at very small sense voltages.

The MAX9922/MAX9923 are capable of both unidirectional and bidirectional operation. For unidirectional operation, connect REF to GND. For bidirectional operation, connect REF to $V_{DD}/2$.

The MAX9922 has adjustable gain set with two external resistors. The MAX9923T/MAX9923H/MAX9923F use an internal laser-trimmed resistor for fixed gain of 25V/V, 100V/V, and 250V/V, respectively. The devices operate from a +2.85V to +5.5V single supply, independent of the input common-mode voltage, and draw only $700\mu\text{A}$ operating supply current and less than $1\mu\text{A}$ in shutdown.

The +1.9V to +28V current-sense input common-mode voltage range makes the MAX9922/MAX9923 ideal for current monitoring in applications where high accuracy, large common-mode measurement range, and minimum full-scale V_{SENSE} voltage is critical.

The MAX9922/MAX9923 use a spread-spectrum autozeroing technique that constantly measures and cancels the input offset voltage, eliminating drift over time and temperature, and the effect of 1/f noise. This, in conjunction with the indirect current-feedback technique, achieves less than $25\mu\text{V}$ (max) offset voltage.

The MAX9922/MAX9923 are available in a small 10-pin μMAX ® package and are specified over the -40°C to $+85^\circ\text{C}$ extended temperature range.

Applications

Notebook/Desktop Power Management
Handheld Li+ Battery Current Monitoring
Precision Current Sources

Typical Operating Circuits appear at end of data sheet.

μMAX is a registered trademark of Maxim Integrated Products, Inc.

Features

- ◆ Ultra-Precision V_{OS} Over Temperature
 - MAX9922: $\pm 10\mu\text{V}$ (max)
 - MAX9923T: $\pm 25\mu\text{V}$ (max)
 - MAX9923H: $\pm 20\mu\text{V}$ (max)
 - MAX9923F: $\pm 10\mu\text{V}$ (max)
- ◆ $\pm 0.5\%$ (max) Full-Scale Gain Accuracy
- ◆ Bidirectional or Unidirectional ISENSE
- ◆ Multiple Gains Available
 - Adjustable (MAX9922)
 - +25V/V (MAX9923T)
 - +100V/V (MAX9923H)
 - +250V/V (MAX9923F)
- ◆ 1.9V to 28V Input Common-Mode Voltage, Independent of V_{DD}
- ◆ Supply Voltage: +2.85V to +5.5V
- ◆ 700 μA Supply Current, 1 μA Shutdown Current
- ◆ Extended Temperature Range (-40°C to $+85^\circ\text{C}$)
- ◆ Available in Space-Saving 10-Pin μMAX

Ordering Information

PART	PIN-PACKAGE	TEMP RANGE	GAIN (V/V)
MAX9922EUB+	10 μMAX	-40°C to $+85^\circ\text{C}$	Adjustable
MAX9923TEUB+	10 μMAX	-40°C to $+85^\circ\text{C}$	25
MAX9923HEUB+	10 μMAX	-40°C to $+85^\circ\text{C}$	100
MAX9923FEUB+	10 μMAX	-40°C to $+85^\circ\text{C}$	250

+Denotes a lead(Pb)-free/RoHS-compliant package.

Pin Configuration

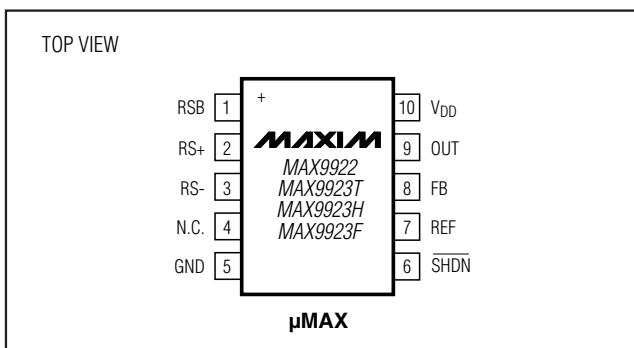

Ultra-Precision, High-Side Current-Sense Amplifiers

ABSOLUTE MAXIMUM RATINGS

RSB, RS+, RS- to GND.....	-0.3V to +30V	Current into Any Pin.....	±20mA
V _{DD} to GND.....	-0.3V to +6V	Continuous Power Dissipation (T _A = +70°C)	
OUT, REF, FB, SHDN		10-Pin μMAX (derate 4.5mW/°C above +70°C).....	362mW
to GND.....	-0.3V to the lower of (V _{DD} + 0.3V) and +6V	Operating Temperature Range.....	-40°C to +85°C
OUT Short Circuit to V _{DD} or GND.....	Continuous	Junction Temperature.....	+150°C
Differential Voltage (V _{RS+} - V _{RS-}), (V _{RSB} - V _{RS+}),		Storage Temperature Range.....	-65°C to +150°C
(V _{RSB} - V _{RS-}).....	±5.5V	Lead Temperature (soldering, 10s).....	+300°C

Stresses beyond those listed under "Absolute Maximum Ratings" may cause permanent damage to the device. These are stress ratings only, and functional operation of the device at these or any other conditions beyond those indicated in the operational sections of the specifications is not implied. Exposure to absolute maximum rating conditions for extended periods may affect device reliability.

ELECTRICAL CHARACTERISTICS

(V_{RSB} = V_{RS+} = V_{RS-} = +12V, V_{DD} = +3.3V, V_{GND} = 0V, V_{REF} = V_{DD}/2 for bidirectional, V_{REF} = 0V for unidirectional, V_{SENSE} = V_{RS+} - V_{RS-} = 0V, MAX9922 is set for A_v = 100V/V (R₁ = 1kΩ, R₂ = 99kΩ), SHDN = V_{DD}, T_A = -40°C to +85°C, unless otherwise noted. Typical values are at T_A = +25°C.) (Note 1)

PARAMETER	SYMBOL	CONDITIONS	MIN	TYP	MAX	UNITS
DC CHARACTERISTICS						
Input Offset Voltage (Notes 2, 3)	V _{OS}	MAX9922 (A _v = 100), V _{SENSE} = 0V, V _{REF} = V _{DD} /2, -40°C ≤ T _A ≤ +85°C		±0.1	±10	μV
		MAX9923T, V _{SENSE} = 0V, V _{REF} = V _{DD} /2, -40°C ≤ T _A ≤ +85°C		±0.2	±25	
		MAX9923H, V _{SENSE} = 0V, V _{REF} = V _{DD} /2 -40°C ≤ T _A ≤ +85°C		±0.2	±20	
		MAX9923F, V _{SENSE} = 0V, V _{REF} = V _{DD} /2, -40°C ≤ T _A ≤ +85°C		±0.1	±10	
Input Offset Voltage Temperature Drift (Notes 2, 4)	TCV _{OS}	MAX9922 (A _v = 100V/V), V _{SENSE} = 0V, V _{REF} = V _{DD} /2, -40°C ≤ T _A ≤ +85°C			±0.05	μV/°C
		MAX9923T, V _{SENSE} = 0V, V _{REF} = V _{DD} /2, -40°C ≤ T _A ≤ +85°C			±0.20	
		MAX9923H, V _{SENSE} = 0V, V _{REF} = V _{DD} /2, -40°C ≤ T _A ≤ +85°C			±0.10	
		MAX9923F, V _{SENSE} = 0V, V _{REF} = V _{DD} /2, -40°C ≤ T _A ≤ +85°C			±0.05	
Input Common-Mode Range	V _{CMR}	Guaranteed by CMRR	1.90		28.00	V
Input Common-Mode Rejection	CMRR	1.9V ≤ V _{RS+} ≤ 28V, -40°C ≤ T _A ≤ +85°C (Note 2)	121	140		dB
Gain	A _v	MAX9922		Adj		V/V
		MAX9923T		25		
		MAX9923H		100		
		MAX9923F		250		

Ultra-Precision, High-Side Current-Sense Amplifiers

MAX9922/MAX9923

ELECTRICAL CHARACTERISTICS (continued)

($V_{RSB} = V_{RS+} = V_{RS-} = +12V$, $V_{DD} = +3.3V$, $V_{GND} = 0V$, $V_{REF} = V_{DD}/2$ for bidirectional, $V_{REF} = 0V$ for unidirectional, $V_{SENSE} = V_{RS+} - V_{RS-} = 0V$, MAX9922 is set for $A_V = 100V/V$ ($R_1 = 1k\Omega$, $R_2 = 99k\Omega$), $\overline{SHDN} = V_{DD}$, $T_A = -40^\circ C$ to $+85^\circ C$, unless otherwise noted. Typical values are at $T_A = +25^\circ C$.) (Note 1)

PARAMETER	SYMBOL	CONDITIONS		MIN	TYP	MAX	UNITS
Gain Accuracy (Note 5)	ΔA_V	MAX9922 ($A_V = 100$)	$T_A = +25^\circ C$	± 0.17	± 0.40	%	
			$-40^\circ C \leq T_A \leq +85^\circ C$	± 0.60			
		MAX9923T	$T_A = +25^\circ C$	± 0.12	± 0.30		
			$-40^\circ C \leq T_A \leq +85^\circ C$	± 0.60			
		MAX9923H	$T_A = +25^\circ C$	± 0.24	± 0.40		
			$-40^\circ C \leq T_A \leq +85^\circ C$	± 0.75			
MAX9923F	$T_A = +25^\circ C$	± 0.21	± 0.50				
	$-40^\circ C \leq T_A \leq +85^\circ C$	± 0.80					
Gain Nonlinearity	$\sim A_V$	MAX9922 ($A_V = 100$)		± 0.06	%		
		MAX9923T		± 0.04			
		MAX9923H		± 0.06			
		MAX9923F		± 0.12			
Open-Loop Gain	A_{VOL}	MAX9922		160		dB	
Input Bias Current	I_{RS+}, I_{RS-}			1		pA	
FB Bias Current	I_{FB}	MAX9922		1		pA	
FB Resistance	R_{FB}	MAX9923T/MAX9923H/MAX9923F resistance between FB and REF		1		k Ω	
REF Input Range		Guaranteed by REF CMRR test	$T_A = +25^\circ C$	0	$V_{DD} - 1.4$	V	
			$-40^\circ C \leq T_A \leq +85^\circ C$	0	$V_{DD} - 1.6$		
REF Common-Mode Rejection Ratio		$0 \leq REF \leq V_{DD} - 1.4V$ (Note 2)		94	100		dB
REF Input Current (Note 6)		MAX9922 (bidirectional)			± 20	μA	
		MAX9923T (bidirectional)		± 60	± 70		
		MAX9923H (bidirectional)		± 16	± 20		
		MAX9923F (bidirectional)		± 6	± 7		
OUT High Voltage	V_{OH}	$V_{OH} = V_{DD} - V_{OUT}$ (Note 7)	$R_L = 10k\Omega$ to GND and REF = GND	7	30	mV	
			$R_L = 10k\Omega$ to V_{DD} and REF = $V_{DD} - 1.4$	1	6		
OUT Low Voltage (Note 7)	V_{OL}	$R_L = 10k\Omega$ to GND and REF = GND		1	10	mV	
		$R_L = 10k\Omega$ to V_{DD} and REF = $V_{DD} - 1.4$		6	30		
\overline{SHDN} Logic-Low	V_{IL}	$V_{DD} = 5.5V$			0.3		V
\overline{SHDN} Logic-High	V_{IH}	$V_{DD} = 5.5V$		$0.6 \times V_{DD}$			V
\overline{SHDN} Input Current	I_{IH}/I_{IL}			0.001	± 1		μA

Ultra-Precision, High-Side Current-Sense Amplifiers

ELECTRICAL CHARACTERISTICS (continued)

($V_{RSB} = V_{RS+} = V_{RS-} = +12V$, $V_{DD} = +3.3V$, $V_{GND} = 0V$, $V_{REF} = V_{DD}/2$ for bidirectional, $V_{REF} = 0V$ for unidirectional, $V_{SENSE} = V_{RS+} - V_{RS-} = 0V$, MAX9922 is set for $A_v = 100V/V$ ($R_1 = 1k\Omega$, $R_2 = 99k\Omega$), $\overline{SHDN} = V_{DD}$, $T_A = -40^\circ C$ to $+85^\circ C$, unless otherwise noted. Typical values are at $T_A = +25^\circ C$.) (Note 1)

PARAMETER	SYMBOL	CONDITIONS	MIN	TYP	MAX	UNITS
AC CHARACTERISTICS						
-3dB Small-Signal Bandwidth	BW	$V_{SENSE} = 10mV_{P-P}$	MAX9922	10		kHz
			MAX9923T	50		
			MAX9923H	10		
		$V_{SENSE} = 5mV_{P-P}$	MAX9923F	2.5		
Slew Rate	SR	$\Delta V_{OUT} = 2V$, $C_{LOAD} = 100pF$		0.4		V/ μs
OUT Settling Time to 1% of Final Value		$C_{LOAD} = 7pF$	MAX9922	200		μs
			MAX9923T	100		
			MAX9923H	200		
			MAX9923F	400		
Input-Voltage Noise Peak-to-Peak		$f_O = 0.1Hz$ to $10Hz$		3.4		μV_{P-P}
Autozeroing Clock Frequency	f_C	Pseudo-random		20		kHz
Capacitive-Load Stability		No sustained oscillations		200		pF
POWER-SUPPLY CHARACTERISTICS						
Supply Voltage Range	V_{DD}	Guaranteed by PSRR	2.85		5.50	V
Power-Supply Rejection Ratio	PSRR	$2.85V \leq V_{DD} \leq 5.5V$, $-40^\circ C \leq T_A \leq +85^\circ C$ (Note 2)	93	99		dB
Quiescent Supply Current	I_{DD}	$V_{DD} = 5.0V$		780	1300	μA
		$V_{DD} = 3.0V$		700	1500	
	I_{RSB}	$V_{RSB} = 12V$		200	300	
Shutdown Supply Current	I_{DD_SD}	$\overline{VSHDN} = 0.3V$		0.05	1	μA
	I_{RSB_SD}	$\overline{VSHDN} = 0.3V$, $V_{RSB} = 28V$		0.05	1	
Power-Down Input Current	I_{RS+L} , I_{RS-L}	$V_{DD} = V_{REF} = 0V$, $V_{RSB} = V_{RS+} = V_{RS-} = 28V$		0.01	0.1	μA

Ultra-Precision, High-Side Current-Sense Amplifiers

MAX9922/MAX9923

ELECTRICAL CHARACTERISTICS (continued)

($V_{RSB} = V_{RS+} = V_{RS-} = +12V$, $V_{DD} = +3.3V$, $V_{GND} = 0V$, $V_{REF} = V_{DD}/2$ for bidirectional, $V_{REF} = 0V$ for unidirectional, $V_{SENSE} = V_{RS+} - V_{RS-} = 0V$, MAX9922 is set for $A_V = 100V/V$ ($R_1 = 1k\Omega$, $R_2 = 99k\Omega$), $\overline{SHDN} = V_{DD}$, $T_A = -40^\circ C$ to $+85^\circ C$, unless otherwise noted. Typical values are at $T_A = +25^\circ C$.) (Note 1)

PARAMETER	SYMBOL	CONDITIONS	MIN	TYP	MAX	UNITS
Power-Down Supply Current	I_{RSBL}	$V_{DD} = V_{REF} = 0V$, $V_{RSB} = V_{RS+} = V_{RS-} = 28V$		0.05	1	μA
Power-Up Time		MAX9922, $A_V = 100V/V$, $V_{REF} = 0V$, $V_{SENSE} = 10mV$, $V_{DD} = 0V$ to $3.3V$, settling to 0.1% of final value		800		μs

Note 1: All devices are 100% production tested at $T_A = +85^\circ C$. All temperature limits are guaranteed by design.

Note 2: V_{OS} is measured in bidirectional mode with $V_{REF} = V_{DD}/2$.

Note 3: Data sheet limits are guaranteed by design and bench characterization. Thermocouple effects preclude measurement of this parameter during production testing. Devices are screened during production testing to eliminate defective units.

Note 4: V_{OS} drift limits are guaranteed by design and bench characterization and are the average of drift from $-40^\circ C$ to $+25^\circ C$ and from $+25^\circ C$ to $+85^\circ C$.

Note 5: $V_{RSB} = V_{RS+} = 12V$, $V_{REF} = V_{DD}/2$ for bipolar mode and $V_{REF} = 0V$ for unipolar mode. Gain accuracy and gain linearity are specified over a V_{SENSE} range that keeps the output voltage 250mV away from the rails to achieve full accuracy. Output of the part is rail-to-rail, and goes to within 25mV of the rails, but accuracy is not maintained. Linear operation is not guaranteed for V_{SENSE} voltages $> \pm 150mV$. See the *Typical Operating Characteristics* section for plots of Input vs. Output.

Note 6: This is the worst-case REF current needed to directly drive the bottom terminal of the gain setting resistors, at $V_{DD} = 3.3V$, and $V_{REF} = V_{DD}/2$ while maintaining gain accuracy. An internal $1k\Omega$ resistor (R_1) is present in the MAX9923T/MAX9923H/MAX9923F between the FB and REF pins, while in the MAX9922 the resistor is external and user selectable. A voltage identical to the V_{SENSE} develops across this resistor. In all versions the REF input current is dependent on the magnitude and polarity of V_{SENSE} , and in the MAX9922 it is dependent on the value of the external resistor as well. The input bias current for REF is typically 1pA in the MAX9922 since it connects to the gate of a MOS transistor. See the *External Reference* section for more details.

Note 7: The range of V_{REF} , V_{CM} , and V_{SENSE} may limit the output swing of the MAX9922 with adjustable gain set to less than 100V/V.

Ultra-Precision, High-Side Current-Sense Amplifiers

Typical Operating Characteristics

($V_{DD} = 3.3V$, $V_{SHDN} = V_{DD}$, $V_{RSB} = V_{RS+} = V_{RS-} = 12V$, $T_A = +25^\circ C$, unless otherwise noted.)

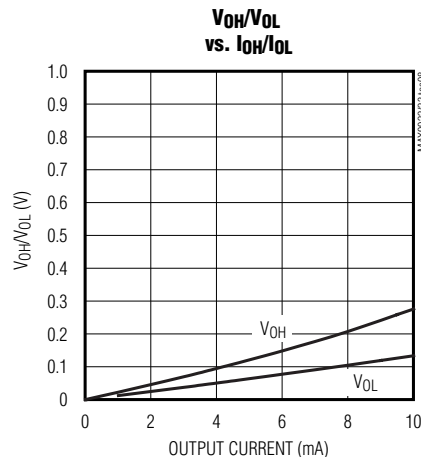
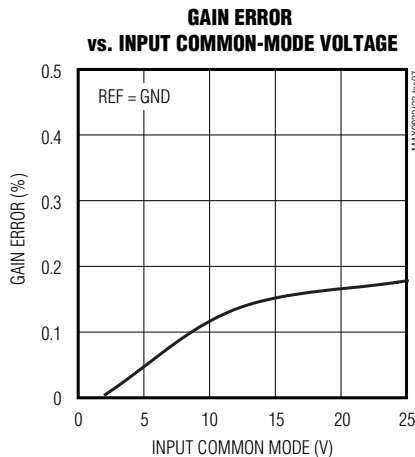
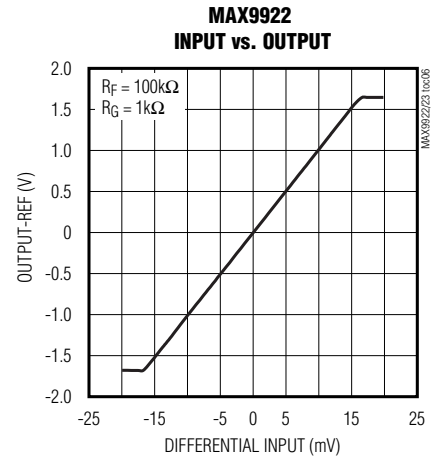
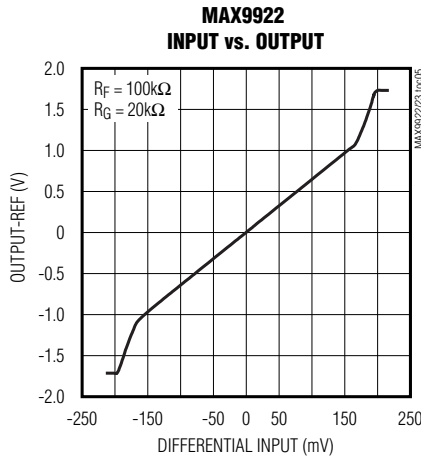
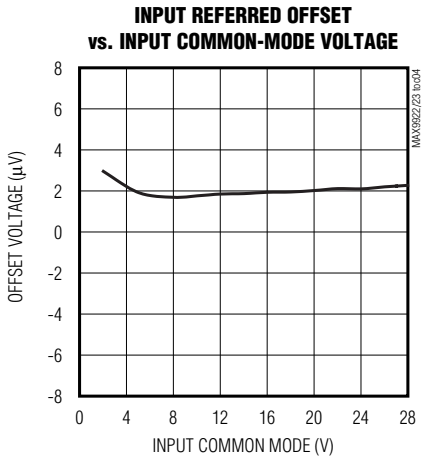
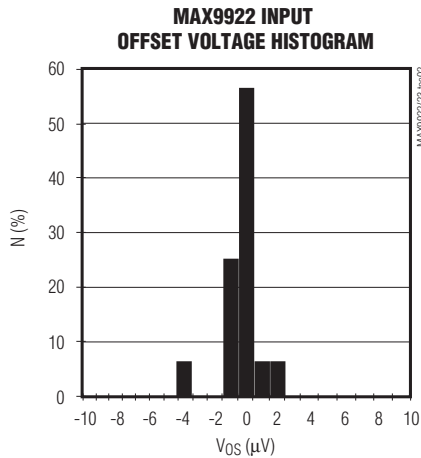
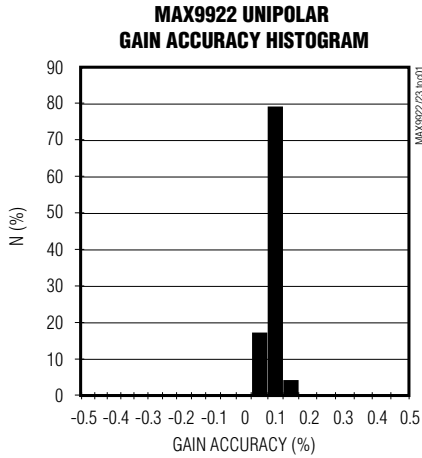

Ultra-Precision, High-Side Current-Sense Amplifiers

MAX9922/MAX9923

Typical Operating Characteristics (continued)

($V_{DD} = 3.3V$, $V_{SHDN} = V_{DD}$, $V_{RSB} = V_{RS+} = V_{RS-} = 12V$, $T_A = +25^\circ C$, unless otherwise noted.)

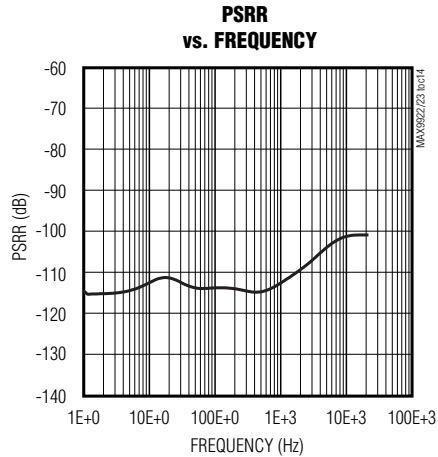
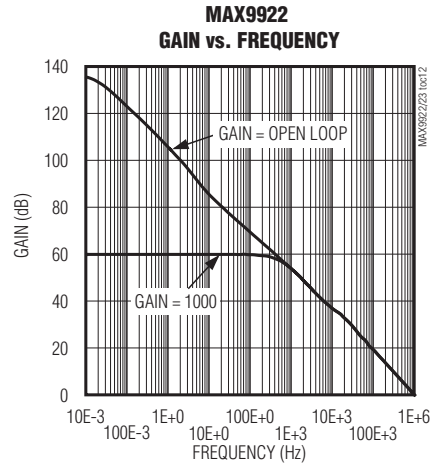
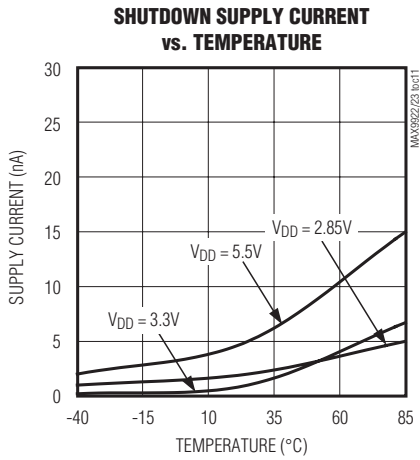
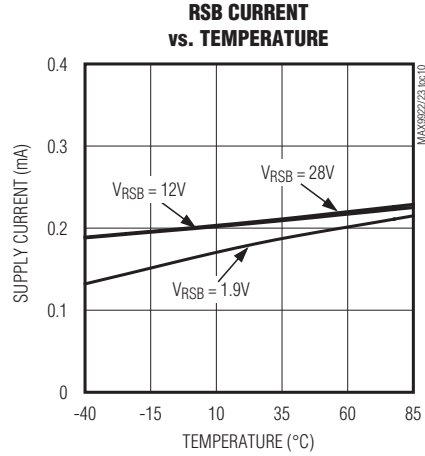
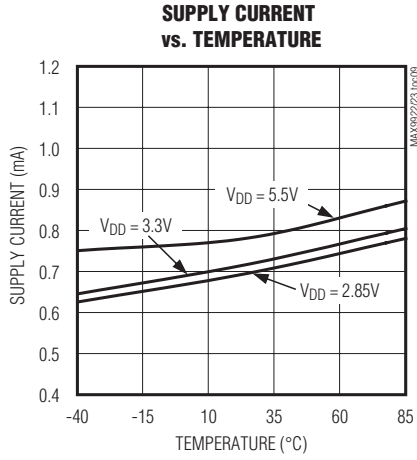

Ultra-Precision, High-Side Current-Sense Amplifiers

Typical Operating Characteristics (continued)

($V_{DD} = 3.3V$, $V_{SHDN} = V_{DD}$, $V_{RSB} = V_{RS+} = V_{RS-} = 12V$, $T_A = +25^\circ C$, unless otherwise noted.)

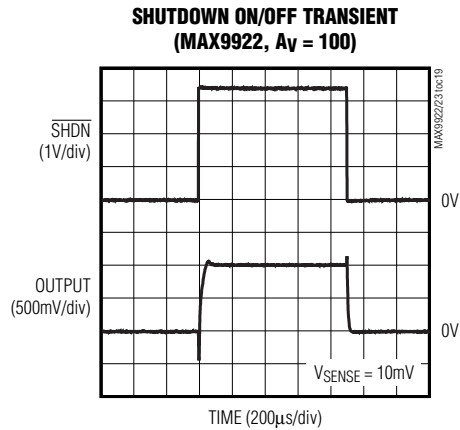
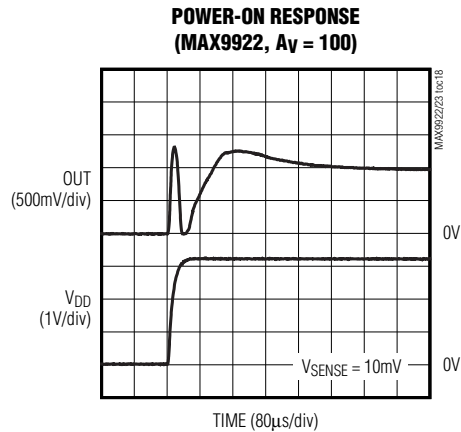
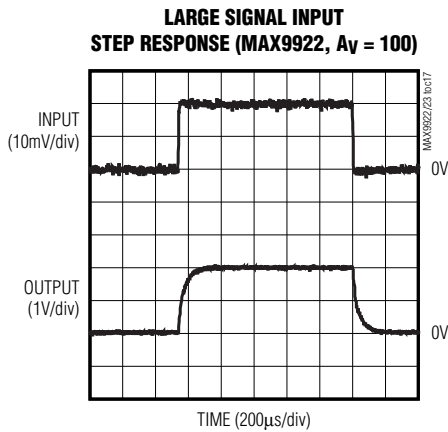
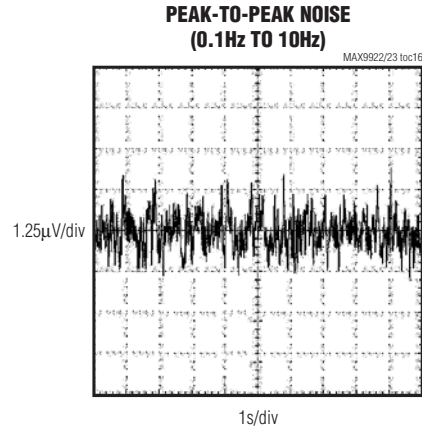

Ultra-Precision, High-Side Current-Sense Amplifiers

Typical Operating Characteristics (continued)

($V_{DD} = 3.3V$, $V_{SHDN} = V_{DD}$, $V_{RSB} = V_{RS+} = V_{RS-} = 12V$, $T_A = +25^\circ C$, unless otherwise noted.)

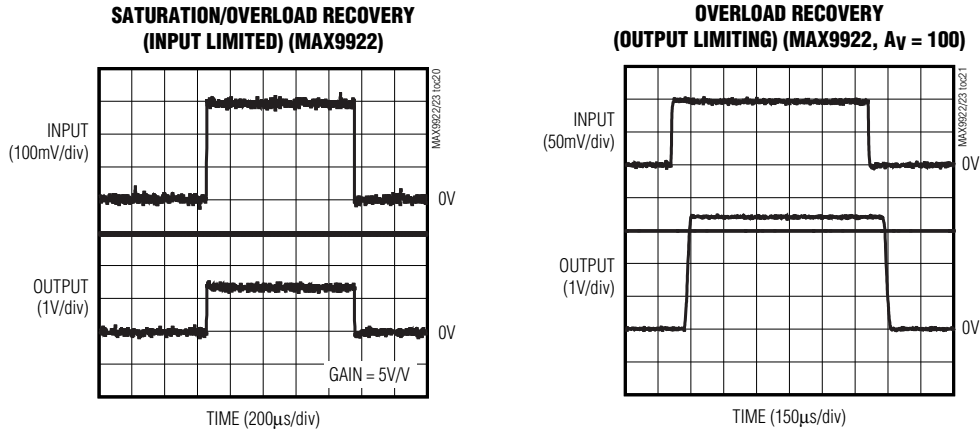

MAX9922/MAX9923

Pin Description

PIN	NAME	FUNCTION
1	RSB	Current-Sense Amplifier Input Stage Supply. Connect to either RS+ or RS-.
2	RS+	Current-Sense Amplifier Positive Input
3	RS-	Current-Sense Amplifier Negative Input
4	N.C.	No Connection. Not internally connected.
5	GND	Ground
6	\overline{SHDN}	Shutdown Logic Input. Connect to GND to reduce quiescent current to 1 μ A. Connect to V_{DD} for normal operation.
7	REF	Reference Voltage Input. Connect to an external voltage to provide a bidirectional current-sense output. Connect to GND for unidirectional operation.
8	FB	Gain-Set Feedback Input. Connect an optional noise reduction capacitor between OUT and FB. MAX9922: Adjustable Gain. Connect a resistive-divider feedback network between OUT, FB, and REF to set the current-sense amplifier gain. Use an external combination of R1 and R2 resistors for gain = $1 + (R2/R1)$. MAX9923T/MAX9923H/MAX9923F: Fixed gain. See the <i>Functional Diagrams</i> .
9	OUT	Voltage Output. V_{OUT} is proportional to V_{SENSE} .
10	V_{DD}	Power-Supply Voltage Input. Bypass to GND with a 0.1 μ F capacitor.

Ultra-Precision, High-Side Current-Sense Amplifiers

Functional Diagrams



Detailed Description

The MAX9922/MAX9923 high-side, current-sense amplifiers implement a spread-spectrum autozeroing technique that minimizes the input offset error, offset drift over time and temperature, and the effect of 1/f noise. This technique achieves less than 25µV (max) offset voltage.

The MAX9922/MAX9923 high-side current-sense amplifiers feature a +1.9V to +28V input common-mode range that is independent of supply voltage (V_{DD}). This feature allows the monitoring of current out of a battery as low as +1.9V and enables high-side current sensing at voltages greater than the supply voltage.

The MAX9922/MAX9923 monitor current through a current-sense resistor and amplify the voltage across the resistor. The 28V input common-mode voltage (V_{RS+}) range of the MAX9922/MAX9923 is independent of the supply voltage (V_{DD}). High-side current monitoring does not interfere with the ground path of the load being measured, making the MAX9922/MAX9923 particularly useful in a wide range of high-voltage systems.

The MAX9922/MAX9923 use Maxim's indirect current feedback architecture. This architecture converts the differential input voltage signal to a current through an input transconductance stage. An output transconductance stage converts a portion of the output voltage (equal to the output voltage divided by the gain) into another precision current. These two currents are subtracted and the result is fed to a loop amplifier with sufficient gain to minimize errors (see the *Functional Diagrams*.)

Battery-powered systems require a precise bidirectional current-sense amplifier to accurately monitor the battery's charge and discharge currents. Measurements of OUT with respect to V_{REF} yield a positive and negative voltage during charge and discharge cycles (Figure 1).

The MAX9922 allows adjustable gain with a pair of external resistors between OUT, FB, and REF. The MAX9923T/MAX9923H/MAX9923F use laser-trimmed internal resistors for fixed gains of 25, 100, and 250, respectively, with 0.5% gain accuracy (see the *Functional Diagrams*.)

Ultra-Precision, High-Side Current-Sense Amplifiers

MAX9922/MAX9923

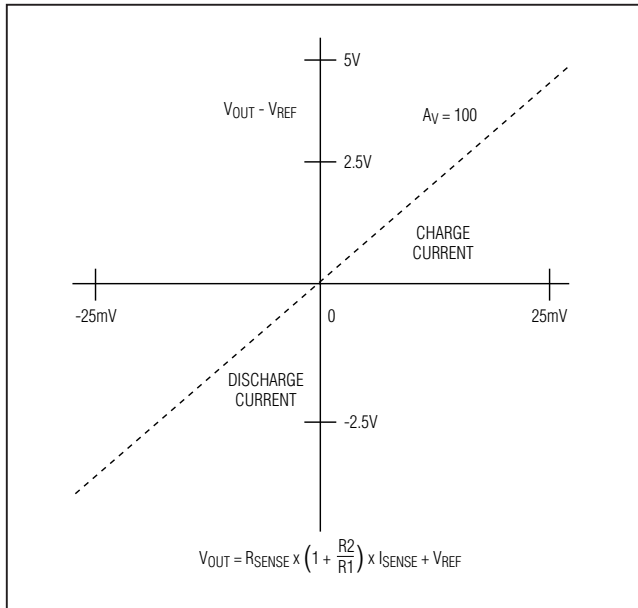

Figure 1. Bidirectional Current-Sense Transfer Function

In bidirectional operation, the external voltage applied to V_{REF} has to be able to supply the current in the feedback network between OUT , FB , and REF . This current is simply the input sense voltage divided by the resistance between FB and REF ($1k\Omega$ typical for MAX9923). Furthermore, ensure the external voltage source supplied to REF has a low source resistance to prevent gain errors (e.g., use a stand-alone reference voltage or an op amp to buffer a high-value resistor string.) See the *Typical Operating Circuits*.

Input Differential Signal Range

The MAX9922/MAX9923 feature a proprietary input structure optimized for small differential signals as low as 10mV full scale for high efficiency with lowest power dissipation in the sense resistor, or +100mV full scale for high dynamic range. The output of the MAX9922/MAX9923 allows for bipolar input differential signals. Gain accuracy is specified over the V_{SENSE} range to keep the output voltage 250mV away from the rails to achieve full accuracy. Output of the part is rail-to-rail and goes to within 25mV of the rails, but accuracy is not maintained. Linear operation is not guaranteed for input sense voltages greater than $\pm 150mV$.

Shutdown

The MAX9922/MAX9923 feature a logic shutdown input to reduce the supply current to less than $1\mu A$. Drive \overline{SHDN} high for normal operation. Drive \overline{SHDN} low to place the device in shutdown mode. In shutdown mode, the current drawn from both the V_{DD} input and the current-sense amplifier inputs (RSB , $RS+$, and $RS-$) is less than $1\mu A$ each.

External Reference

The MAX9922/MAX9923 are capable of both unidirectional and bidirectional operation. For unidirectional current-sense applications, connect the REF input to GND . For bidirectional, connect REF to a reference. This sets bidirectional current sense with $V_{OUT} = V_{REF}$ for $V_{SENSE} = 0mV$. Positive V_{SENSE} causes OUT to swing toward the positive supply, while negative V_{SENSE} causes OUT to swing toward GND . This feature allows the output voltage to measure both charge and discharge currents. Use $V_{REF} = V_{DD}/2$ for maximum dynamic range.

Applications Information

Power Supply, Bypassing, and Layout

Good layout technique optimizes performance by decreasing the amount of stray capacitance at the high-side, current-sense amplifier gain-setting pins, FB to REF and FB to GND . Capacitive decoupling between V_{DD} to GND of $0.1\mu F$ is recommended. Since the MAX9922/MAX9923 feature ultra-low input offset voltage, board leakage and thermocouple effects can easily introduce errors in the input offset voltage readings when used with high-impedance signal sources. Minimize board leakage current and thermocouple effects by thoroughly cleaning the board and placing the matching components very close to each other and with appropriate orientation. For noisy digital environments, the use of a multilayer printed circuit board (PCB) with separate ground and power-supply planes is recommended. Keep digital signals far away from the sensitive analog inputs. Unshielded long traces at the input and feedback terminals of the amplifier can degrade performance due to noise pick-up.

Ultra-Precision, High-Side Current-Sense Amplifiers

Optional Noise Reduction Capacitor

A noise reduction capacitance of $\sim 1\text{nF}$ can be connected between OUT and FB, if needed. Noise reduction is achieved by both limiting the amplifier bandwidth, reducing contribution of broadband white noise and by attenuating contribution of any small 20kHz autozero ripple that appears at the output. Using higher values of feedback capacitance reduces the output noise of the amplifier, but also reduces its signal bandwidth.

Efficiency and Power Dissipation

At high current levels, the I^2R losses in R_{SENSE} can be significant. Take this into consideration when choosing the resistor value and its power dissipation (wattage) rating. The sense resistor's value will drift if it is allowed to heat up excessively. The precision V_{OS} of the MAX9922/MAX9923 allows the use of small sense resistors to reduce power dissipation and reduce hot spots.

Sense Resistor Connections

Take care to prevent solder and trace resistance from causing errors in the sensed voltage because of the high currents that flow through R_{SENSE} . Either use a four terminal current-sense resistor or use Kelvin (force and sense) PCB layout techniques to minimize these errors.

Ultra-Precision, High-Side Current-Sense Amplifiers

MAX9922/MAX9923

Typical Operating Circuits

Unidirectional Mode

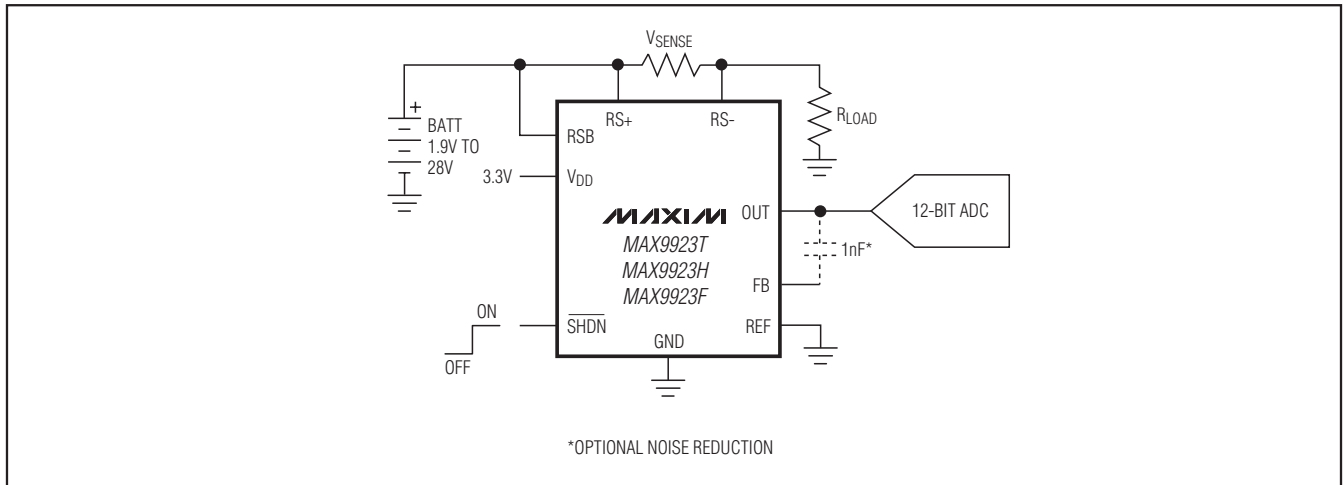

Bidirectional Mode

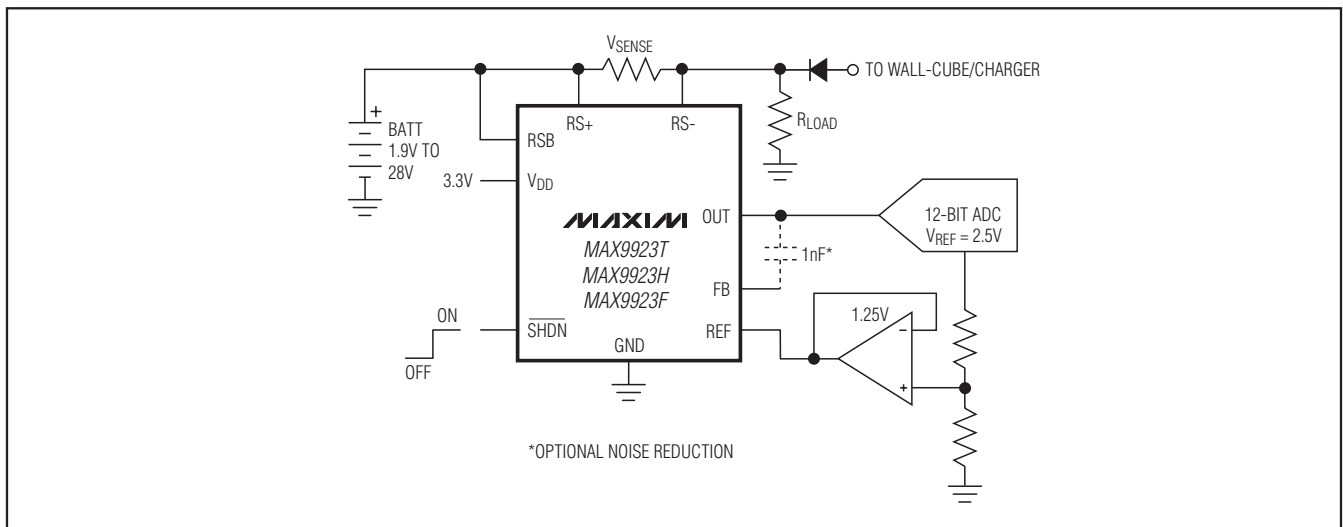

Chip Information

PROCESS: BiCMOS

Ultra-Precision, High-Side Current-Sense Amplifiers

Package Information

For the latest package outline information and land patterns, go to www.maxim-ic.com/packages. Note that a "+", "#", or "-" in the package code indicates RoHS status only. Package drawings may show a different suffix character, but the drawing pertains to the package regardless of RoHS status.

PACKAGE TYPE	PACKAGE CODE	DOCUMENT NO.
10 μ MAX	U10-2	21-0061

DIM	INCHES		MILLIMETERS	
	MIN	MAX	MIN	MAX
A	—	0.043	—	1.10
A1	0.002	0.006	0.05	0.15
A2	0.030	0.037	0.75	0.95
D1	0.116	0.120	2.95	3.05
D2	0.114	0.118	2.89	3.00
E1	0.116	0.120	2.95	3.05
E2	0.114	0.118	2.89	3.00
H	0.187	0.199	4.75	5.05
L	0.0157	0.0275	0.40	0.70
L1	0.037	REF	0.940	REF
b	0.007	0.0106	0.177	0.270
e	0.0197	BSC	0.500	BSC
c	0.0035	0.0078	0.090	0.200
S	0.0196	REF	0.498	REF
α	0°	6°	0°	6°

Pkg Codes: U10-2; U10CN-1

NOTES:
 1. D&E DO NOT INCLUDE MOLD FLASH.
 2. MOLD FLASH OR PROTRUSIONS NOT TO EXCEED 0.15mm (.006").
 3. CONTROLLING DIMENSION: MILLIMETERS.
 4. COMPLIES TO JEDEC MO-187, LATEST REVISION, VARIATION BA.
 5. MARKING SHOWN IS FOR PKG. ORIENTATION ONLY.
 6. ALL DIMENSIONS APPLY TO BOTH LEADED (-) AND PbFREE (+) PKG. CODES.

—DRAWING NOT TO SCALE—

10LUMAXEPS

Ultra-Precision, High-Side Current-Sense Amplifiers

Revision History

REVISION NUMBER	REVISION DATE	DESCRIPTION	PAGES CHANGED
0	3/09	Initial release	—
1	1/10	Updated conditions for REF input current and Note 6	3, 5

MAX9922/MAX9923

Maxim cannot assume responsibility for use of any circuitry other than circuitry entirely embodied in a Maxim product. No circuit patent licenses are implied. Maxim reserves the right to change the circuitry and specifications without notice at any time.

Maxim Integrated Products, 120 San Gabriel Drive, Sunnyvale, CA 94086 408-737-7600 _____ 15