

## Connections and terminals

### Line terminal X 221 503 01

suitable for

**Power-D-Box with sockets pre-wired**

**Line terminal (max. 63 A)**  
**X 221 503 01**

max. tightening torque 3.0 Nm

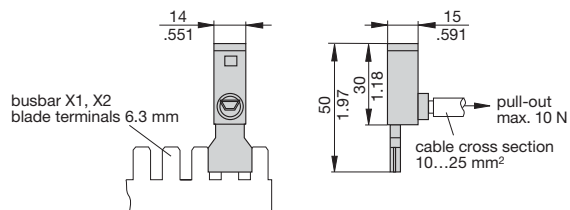

**Caution:** cables must not be connected with terminal plugged in

### Load output terminal protected against reverse polarity X 222 847 01 X 222 625 01 X 222 848 01

suitable for

**19BGT-2-X8340-S02**  
**19BGT-2-X8340-SZ4**  
**X8340-S02**  
**X8340-SZ4**

**Load output terminal protected against reverse polarity**  
(set: 4 moduled sleeves, 8 blade terminals 6.3 x 0.8 mm)

**X 222 847 01** for cable cross section 0.7 ...2.0 mm<sup>2</sup>

**X 222 625 01** for cable cross section 2.5 ...4.0 mm<sup>2</sup>

**X 222 848 01** for cable cross section 4.0 ...6.0 mm<sup>2</sup>

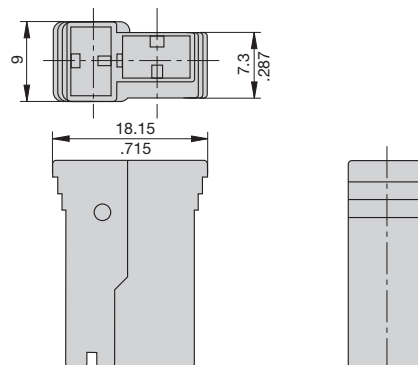

### Screw terminal X 211 156 01

suitable for

**Module 17plus**

**Screw terminal for busbar Y 307 016 11**

**X 211 156 01**  
non insulated  
(max. 35 m<sup>2</sup>)

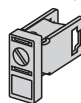

**Labels**

**Label**  
 marking area 6 x 10 mm / .629 x .394 in.  
**Y 307 942 61**

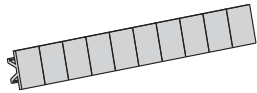

**Label white Y 307 942 61**  
**ordering unit 10 pcs = 1 strip**

suitable for **Module 17plus**

**Label**  
 marking area 16 x 13 mm / .629 x .512 in.  
**Y 308 327 01**

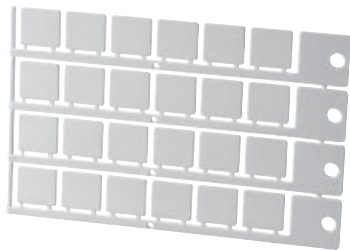

**Label white Y 308 327 01**  
**ordering unit 24 pcs = 1 plate**

suitable for **19BGT-2-X83S2**  
**19BGT-2-X83S4**  
**19BGT-2-X83Z4**  
**19BGT-2-X8345**

**Label**  
 marking area 46 x 13 mm / 1.81 x .512 in.  
**Y 308 328 01**



**Label white Y 308 328 01**  
**ordering unit 8 pcs = 1 plate**

suitable for **19BGT-2-2210**  
**19BGT-2-3600**  
**19BGT-2-ESS20**  
**19BGT-2-ESX10**  
**19BGT-2-X2210**

**Blanking piece**

**Blanking piece Y 308 563 01**

suitable for **19BGT-2-2210**  
**19BGT-2-3600/3900**

**Blanking piece for Power-D-Box**  
(circuit breaker types 3600/3900, 2210)  
**Y 308 563 01**

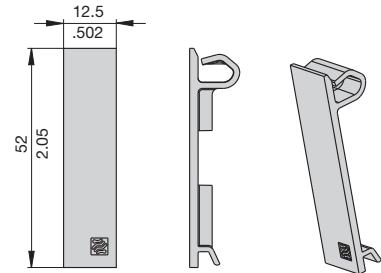

**Blanking piece Y 308 563 41**

suitable for **19BGT-2-ESS20**  
**19BGT-2-ESX10**

**Blanking piece for Power-D-Box**  
(circuit breaker types ESS20, ESX10)  
**Y 308 563 41**

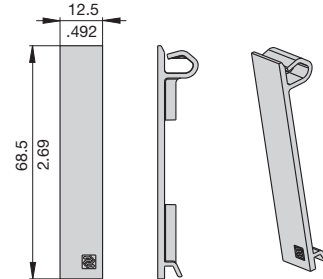

**Blanking piece Y 308 563 21**

suitable for **19BGT-2-X8345**  
**19BGT-2-X83S2**  
**19BGT-2-X83S4**  
**19BGT-2-X83Z4**

**Blanking piece for Power-D-Box**  
(circuit breaker types 8345, X8345-D01)  
**Y 308 563 21**

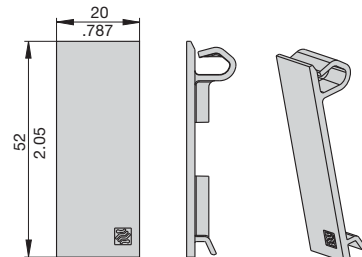

**Mounting aids**

**Retaining clip for electronic circuit breaker ESS20/ESX10**  
recommended for fitting the devices  
**Y 307 754 01**

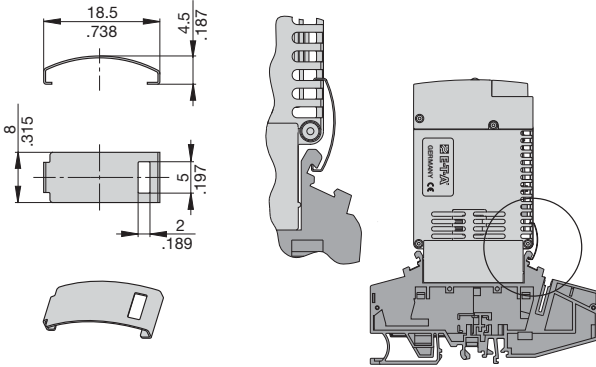

**Retaining clip Y 307 754 01**

suitable for

**Module 17 plus mit ESS20**  
**Module 17 plus mit ESX10**

**Retaining clip for circuit breaker 3600/3900/E-1048/E-1079**  
recommended for fitting the devices  
**Y 300 581 11**

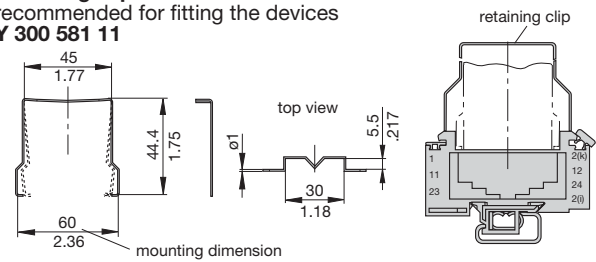

**Retaining clip Y 300 581 11**

suitable for

**socket type 17...**  
**with 3600**  
**3900**  
**E-1048-6..**  
**E-1048-7..**  
**E-1079-6..**

**Module 17plus**  
**with 3600**  
**3900**  
**E-1048-6..**  
**E-1048-7..**  
**E-1079-6..**

**Retaining clip for circuit breaker 2210**  
recommended for fitting single pole devices  
**Y 302 974 21**

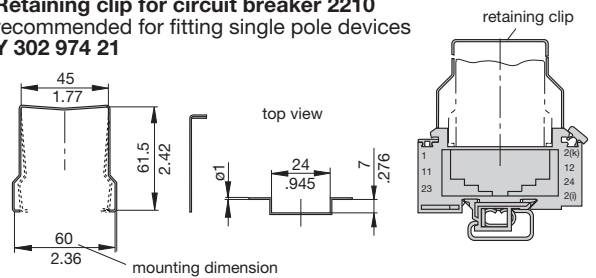

**Retaining clip Y 302 974 21**

suitable for

**socket type 17...**  
**with 2210-...**

**Module 17plus**  
**with 2210-...**

**Retaining clip for circuit breaker 3600/3900/E-1048/E-1079**  
recommended for fitting the devices  
**Y 300 581 03**

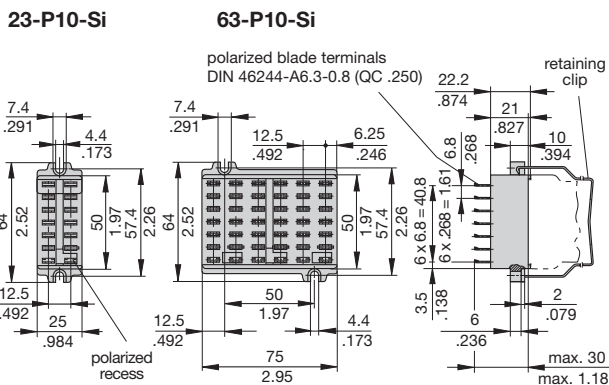

**Retaining clip Y 300 581 03**

suitable for

**socket type 23...**  
**with 3600**  
**3900**  
**E-1048-6..**  
**E-1048-7..**  
**E-1079-6..**

**socket type 63...**  
**with 3600**  
**3900**  
**E-1048-6..**  
**E-1048-7..**  
**E-1079-6..**

7

## Mounting aids

### Retaining clip Y 302 974 01

suitable for

socket type 23...  
with 2210-S...

socket type 63...  
with 2210-S...

**Retaining clip for circuit breaker 2210-S...**  
recommended for fitting single pole devices  
**Y 302 974 01**

**23-P10-Si**

**63-P10-Si**

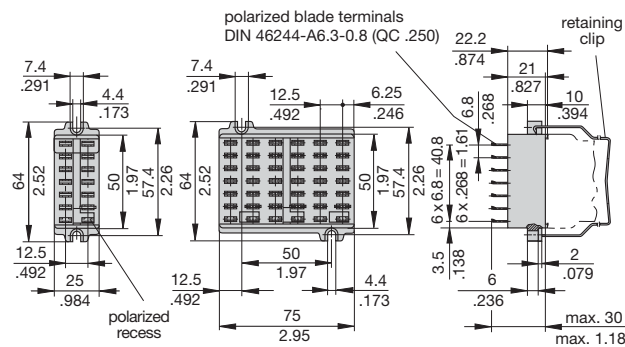

### Screw and washer X 223 019 01 1 set with 4 screw and 4 washers in a plastic bag

suitable for

**19BGT-...**

**Sufficient for mounting one Power-D-Box**

**Screw and washer**  
screw for mounting the Power-D-Box (19BGT)  
**X 223 019 01**



### Barrier Y 308 139 01

suitable for

**19BGT-2-X8345  
X8345-D01**

**Barrier**  
for isolating the load terminals of the Power-D-Box (High-Power)  
**Y 308 139 01**



### End bracket X 222 004 01

suitable for

**Module 17plus  
socket type 17**

**End bracket**  
recommended for fixing on symmetrical rails  
**X 222 004 01**

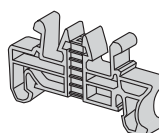

## Busbars and jumpers

**Insulated wire bridge**  
**X 222 984 01**  
 packaging quantity: 10 pcs

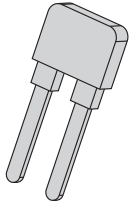

**Insulated wire bridge X 222 984 01**  
 packaging quantity 1 pc = 10 wire bridges

suitable for **SVS.**

**Bus bar 32 A**  
**X 222 005 01** blue insulated, 500 mm  
**X 222 005 02** red insulated, 500 mm  
**X 222 005 03** grey insulated, 500 mm

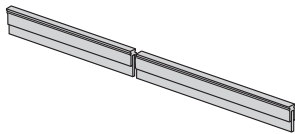

**Bus bar 32 A**      **X 222 005 01** blue  
                          **X 222 005 02** red  
                          **X 222 005 03** grey

suitable for **Module 17plus**

**Bus bar 50 A**  
**Y 307 016 01** non insulated, 500 mm

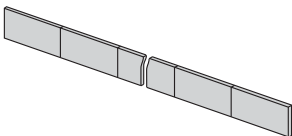

**Bus bar 50 A Y 307 016 01**

suitable for **Module 17plus**

**Bus bar for line entry on the side**  
 (in combination with screw terminal X 211 156 01)  
**Y 307 016 11** non insulated, 500 mm

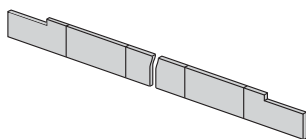

**Busbar Y 307 016 11**  
 for line entry on the side

suitable for **Module 17plus**

**Jumper**  
**X 222 066 01**

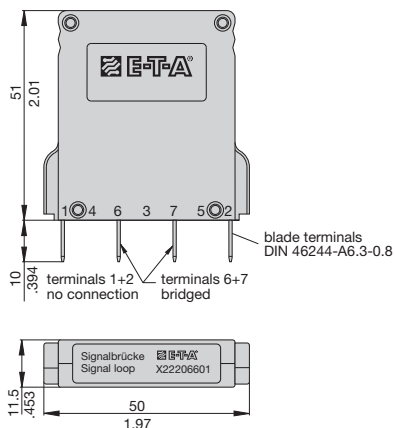

**Jumper X 222 066 01 old version**

suitable for **Module 17plus**  
**SVS.**  
**19BGT-2-2210**  
**19BGT-2-3600/3900**  
**19BGT-2-ESS20**  
**9BGT-2-ESX10**

**New version see jumper SB-S11-P1-01-1-1A**

**Busbars and jumpers**

**Jumper SB-S11-P1-01-1-1A**

suitable for

- Module 17 plus**
- SVS...**
- 19BGT-2-2210**
- 19BGT-2-3600/390**
- 19BGT-2-ESS20**
- 19BGT-2-ESX10**

**Jumper  
SB-S11-P1-01-1-1A**

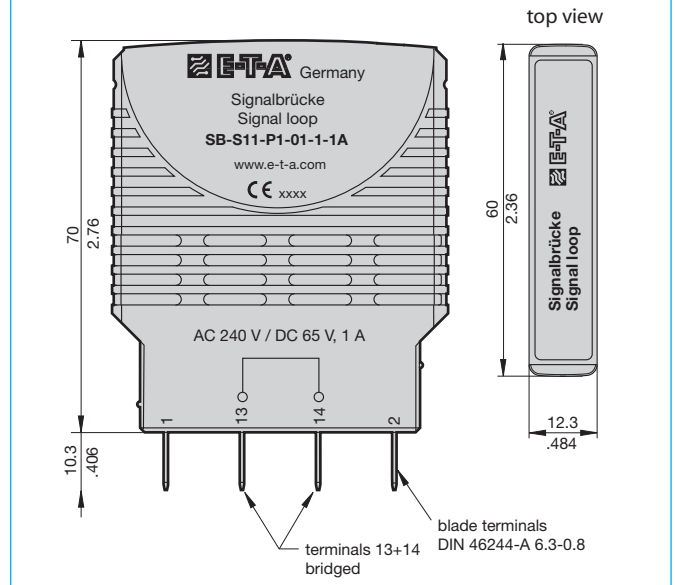

**Tools**

**Withdrawal tool for ESS20 /ESX10  
Y 308 602 01**

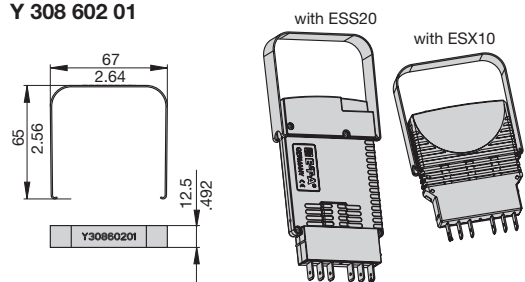

**Withdrawal tool Y 308 602 01**

suitable for **19BGT-2-ESS20  
19BGT-2-ESX10**

**Withdrawal tool  
for removing circuit breaker type 8345  
X 222 547 02**

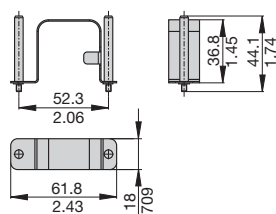

**Withdrawal tool X 222 547 02**

suitable for **19BGT-2-X8345  
X8345-D01**

**Withdrawal tool  
for removing circuit breaker type 2210-S291  
X 211 018 01**



**Withdrawal tool X 211 018 01**

suitable for **19BGT-2-X2210  
X2210-S06...**