

Superior high Flux for High Current System

Z Power Chip on board – ZC series, ZC18

SDW03F1C, SDW83F1C



19 x 19 (mm²)



Product Brief

Description

- The ZC(Z-Power Chip on board) series are High Flux and High Efficiency.
- It is COB (Chip On Board) series designed for easy to attach to lighting fixture directly without reflow process.
- ZC series' thermal management perform exceeds other power LED solutions.
- MacAdam 3 step, 4-step available including ANSI.
- Provide COB total solution available(Optic, reflector, holder etc.)
- The Z-Power LED is ideal light sources for general illumination applications, custom designed solutions, and high performance lights.

Features and Benefits

- Super high Flux output and high Luminance
- Designed for high current operation
- Design flexibility
- MacAdam 3-step
- Lead Free product
- RoHS compliant

Key Applications

- Down Light / PAR
- Architectural lighting
- Decorative / Pathway lighting

Table 1. Product Selection Table

Part Number	CCT			
	Color	Min.	Typ.	Max.
SDW03F1C	Cool White	4700K	5300K	6000K
SDW83F1C	Warm White		3000K	
SDW83F1C	Warm White		2700K	

Table of Contents

Index	
•	Product Brief
•	Table of Contents
•	Product Nomenclature (Labeling Information)
•	Performance Characteristics
-	Relative Spectral Distribution
-	Luminous Flux Characteristics
-	Forward Current Characteristics
-	Junction Temperature Characteristics
-	Ambient Temperature Characteristics
•	Color Bin Structure
•	Packaging Information
-	Mechanical Dimensions
-	Tray packaging structure
-	Packing (bag & box)
•	Handling of Silicone Resin for LEDs
•	Precaution For Use
•	Revision History
•	Company Information

Product Nomenclature

Table 2. Part Numbering System : X₁X₂X₃ X₄X₅ X₆X₇ X₈

Part Number Code	Description	Part Number	Value
X ₁	Company	S	
X ₂	Package series	D	
X ₃	Color Specification	W0	White
X ₄		W8	CRI 80
X ₅	Series number	3	
X ₆	Lens type	F	Flat
X ₇	PCB type	1	PCB
X ₈	Revision number	C	New COB type

Table 3. Lot Numbering System : Y₁Y₂Y₃Y₄Y₅Y₆ – Y₇Y₈Y₉Y₁₀ – Y₁₁Y₁₂Y₁₃

Lot Number Code	Description	Lot Number	Value
Y ₁ Y ₂	Year		
Y ₃ Y ₄	Month		
Y ₅ Y ₆	Day		
Y ₇ Y ₈ Y ₉ Y ₁₀	Mass order		
Y ₁₁ Y ₁₂ Y ₁₃	Tray No.		

Performance Characteristics

Table 4. Product Selection Guide, $T_A = 25^\circ\text{C}$, RH30%

Part Number	CCT (K) ^[1]	Typical Luminous Flux ^[2] Φ_v ^[3] (lm)		Typical Forward Voltage (V_f) ^[4]		CRI ^[5] , R_a	Viewing Angle (degrees) $2\theta_{1/2}$
	Typ.	500mA	640mA*	500mA	640mA*	Min.	Typ.
SDW03F1C	5000	2520	3090	37	38.5	70	120
SDW83F1C	3000	2150	2640	37	38.5	80	120
SDW83F1C	2700	2050	2520	37	38.5	80	120

Notes :

1. Correlated Color Temperature is derived from the CIE 1931 Chromaticity diagram. Color coordinate : ± 0.01 , CCT $\pm 5\%$ tolerance.
2. SSC maintains a tolerance of $\pm 7\%$ on flux and power measurements.
3. Φ_v is the total luminous flux output as measured with an integrating sphere.
4. Tolerance is $\pm 2.5\text{V}$ on forward voltage measurements.
5. Tolerance is ± 2 on CRI measurements.

* Calculated performance values are for reference only.

Performance Characteristics

Table 5. Characteristics, $T_A = 25^\circ\text{C}$, RH30%

Parameter	Symbol	Value			Unit
		Min.	Typ.	Max.	
Forward Current	I_F	-	0.5	0.64	A
Power Dissipation	P_d	-	18.6	24.4	W
Junction Temperature ^[1]	T_j	-	-	125	$^\circ\text{C}$
Operating Temperature	T_{opr}	-40	-	85	$^\circ\text{C}$
Storage Temperature	T_{stg}	-40	-	100	$^\circ\text{C}$
Thermal resistance (J to S)	$R\theta_{J-S}$	-	0.7	-	K/W
ESD Sensitivity(HBM) ^[2]	-	-	-	± 8	kV

Notes :

1. $I_F \leq 640\text{mA}$
2. At thermal Resistance, J to S means junction to COB's metal pcb bottom.
3. A zener diode is included to protect the product from ESD.

Relative Spectral Distribution

Fig 1. Color Spectrum, $T_a = 25^\circ\text{C}$, $I_F = 500\text{mA}$, $\text{RH}30\%$

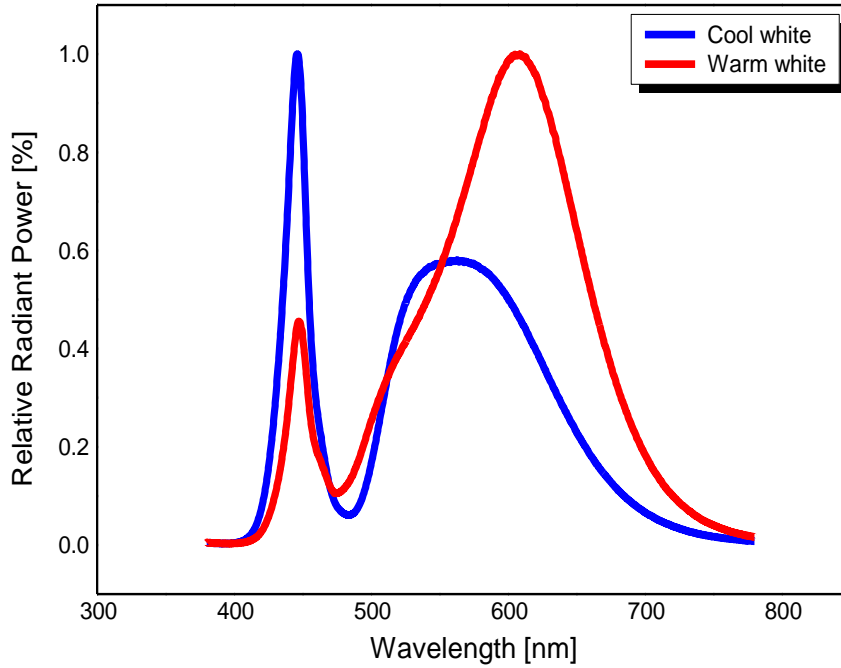

Luminous Flux Characteristics

Fig 2. Radiant pattern, IF = 500mA

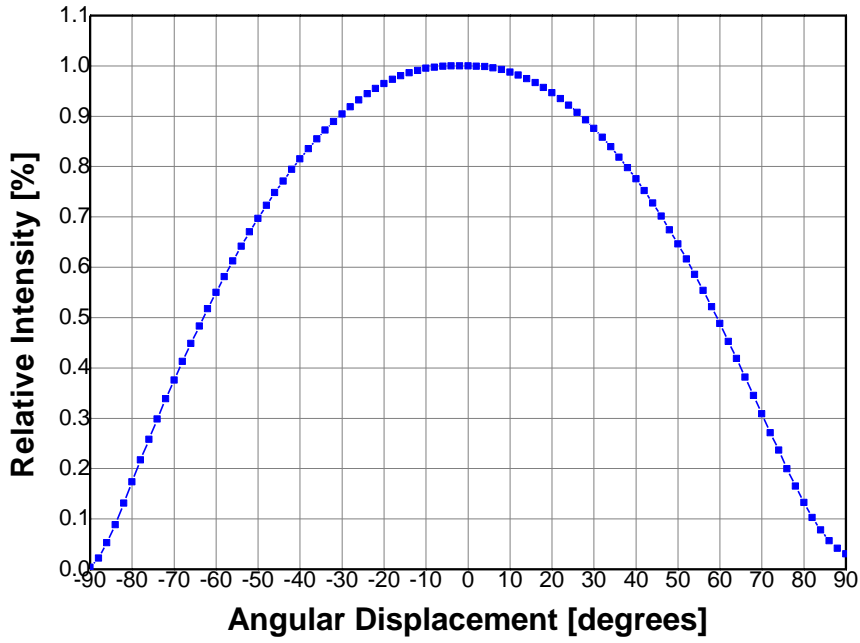

Forward Current Characteristics

Fig 3. Forward Voltage vs. Forward Current , Ta=25 °C

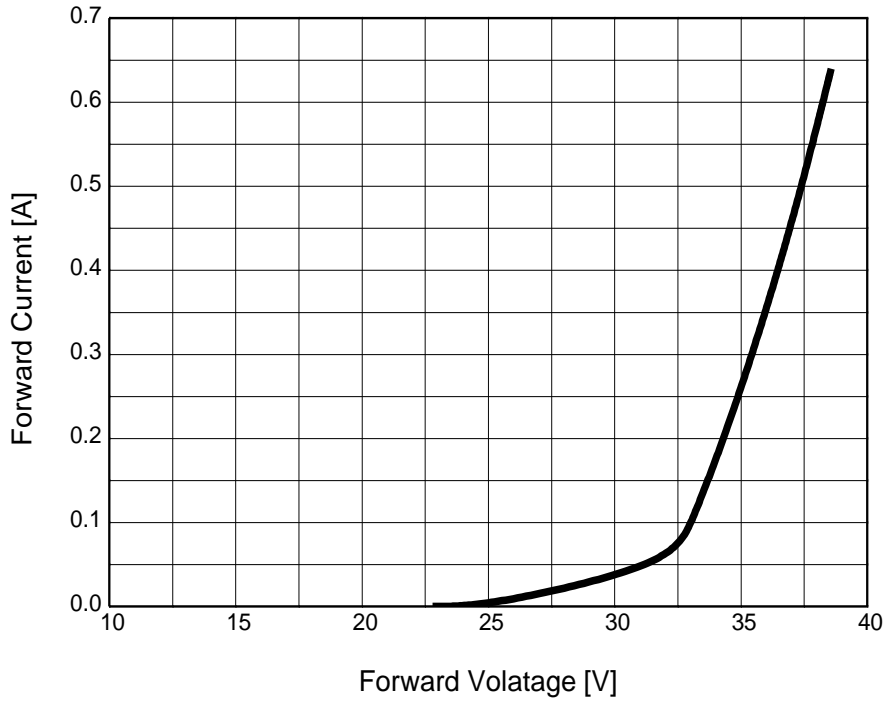
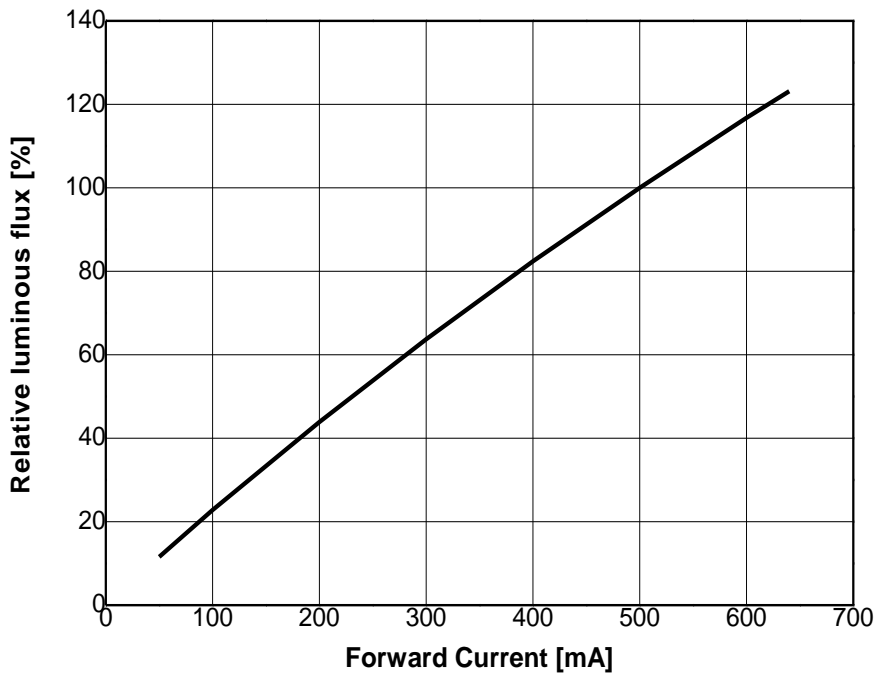
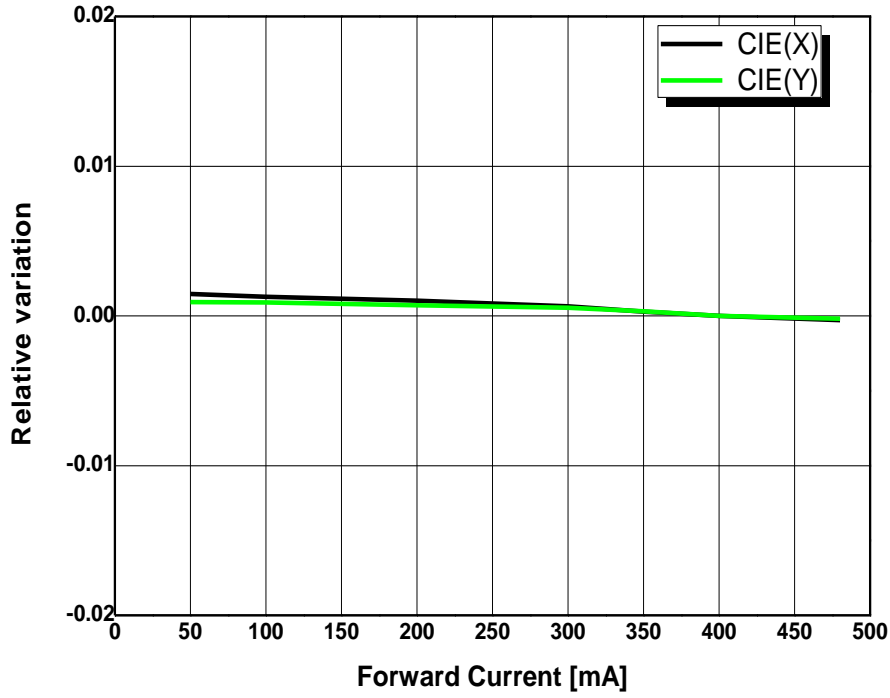

Fig 4. Forward Current vs. Relative Luminous Flux, Ta=25 °C



Forward Current Characteristics

Fig 5. Forward Current vs. CIE X, Y Shift , Ta=25°C (Warm white)



Junction Temperature Characteristics

Fig 6. Relative Light Output vs. Junction Temperature, IF=500mA

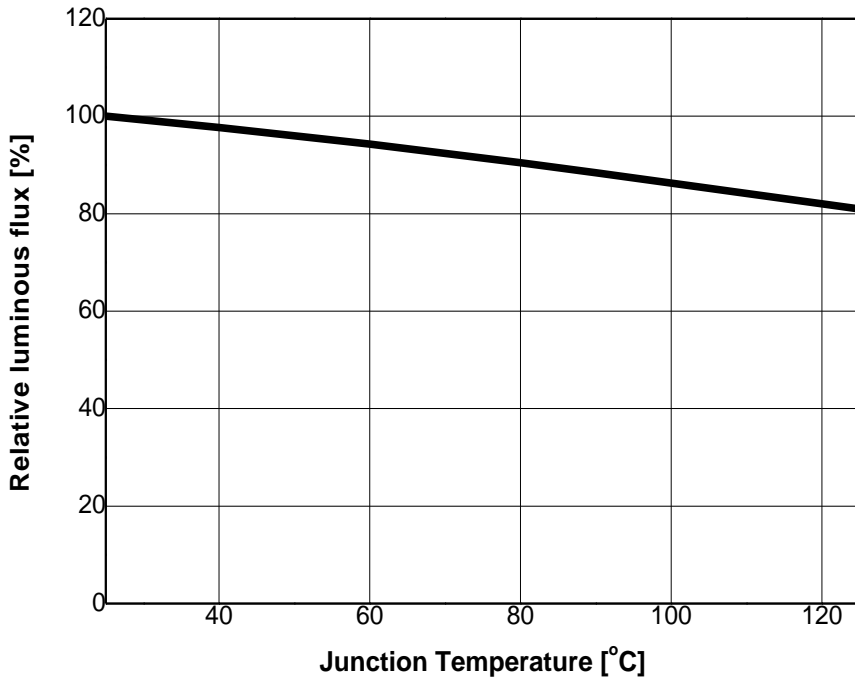
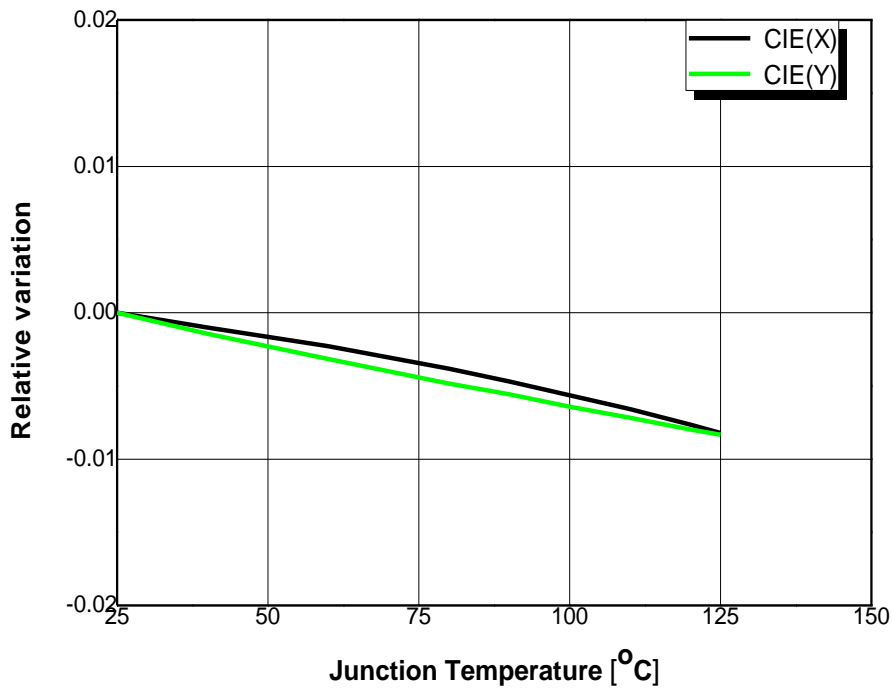
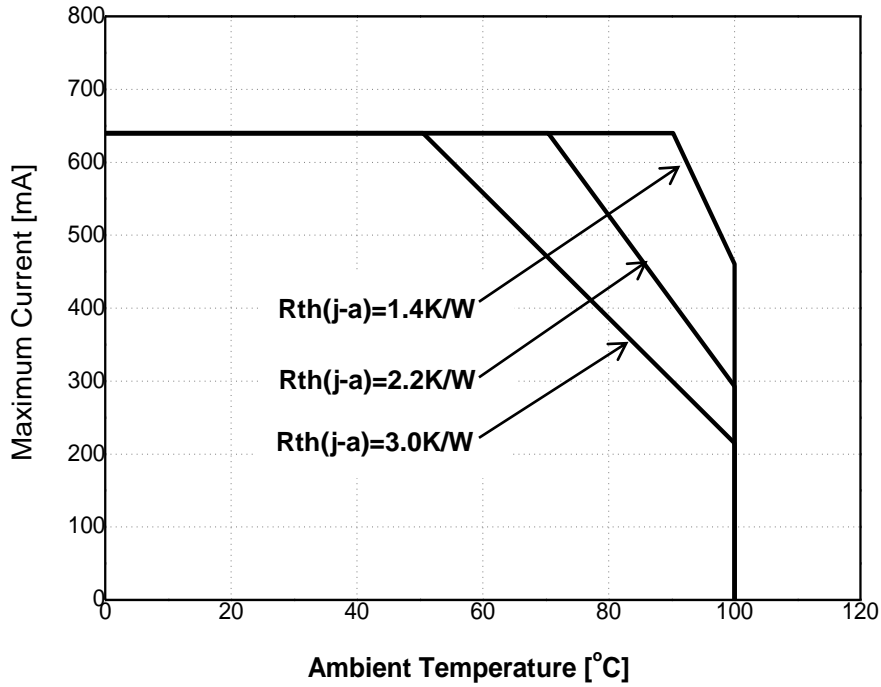

Fig 7. Junction Temp. vs. CIE X, Y Shift, IF=500mA (Warm white)



Ambient Temperature Characteristics

Fig 8. Maximum Forward Current vs. Ambient Temperature, $T_{j(max.)} = 125^{\circ}\text{C}$, $I_F=0.64\text{A}$



Color Bin Structure

Table 6. Bin Code description

Part Number	Luminous Flux (lm) @ $I_F = 500\text{mA}$			Color Chromaticity Coordinate @ $I_F = 500\text{mA}$	Typical Forward Voltage (V_f)		
	Bin Code	Min.	Max.		Bin Code	Min.	Max.
SDW03F1C	H1	1800	2400	Refer to page.13	D	32.0	36.0
	H2	2400	2900		E	36.0	40.0
SDW83F1C	G2	1600	1800	Refer to page.14	D	32.0	36.0
	H1	1800	2400		E	36.0	40.0

Color Bin Structure

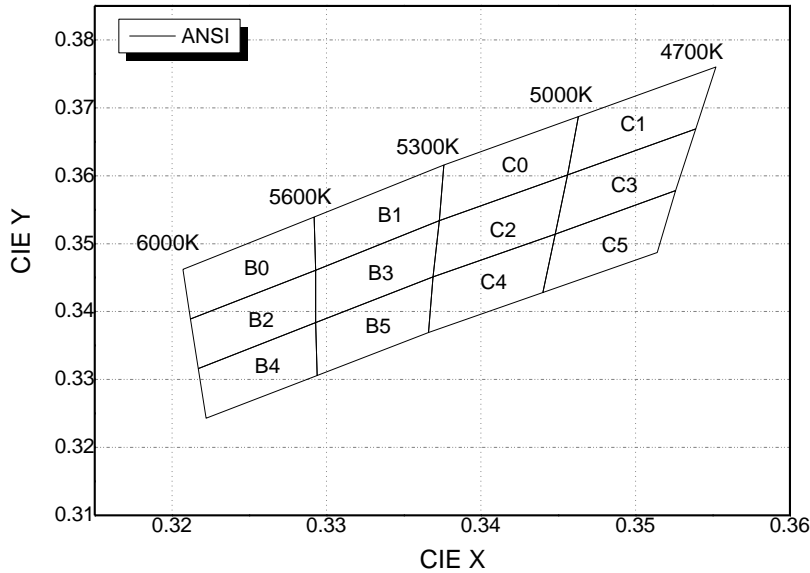
CIE Chromaticity Diagram (Cool white), Ta=25°C, IF=500mA

B0		B1		B2		B3		B4	
CIE x	CIE y	CIE x	CIE y	CIE x	CIE y	CIE x	CIE y	CIE x	CIE y
0.3207	0.3462	0.3292	0.3539	0.3212	0.3389	0.3293	0.3461	0.3217	0.3316
0.3212	0.3389	0.3293	0.3461	0.3217	0.3316	0.3293	0.3384	0.3222	0.3243
0.3293	0.3461	0.3373	0.3534	0.3293	0.3384	0.3369	0.3451	0.3294	0.3306
0.3292	0.3539	0.3376	0.3616	0.3293	0.3461	0.3373	0.3534	0.3293	0.3384
B5		B6		B7		B8		B9	
CIE x	CIE y	CIE x	CIE y	CIE x	CIE y	CIE x	CIE y	CIE x	CIE y
0.3293	0.3384	0.3222	0.3243	0.3294	0.3306	0.3200	0.3572	0.3290	0.3656
0.3294	0.3306	0.3226	0.3178	0.3295	0.3234	0.3207	0.3462	0.3292	0.3539
0.3366	0.3369	0.3295	0.3234	0.3364	0.3288	0.3292	0.3539	0.3376	0.3616
0.3369	0.3451	0.3294	0.3306	0.3366	0.3369	0.3290	0.3656	0.3381	0.3740
C0		C1		C2		C3		C4	
CIE x	CIE y	CIE x	CIE y	CIE x	CIE y	CIE x	CIE y	CIE x	CIE y
0.3376	0.3616	0.3463	0.3687	0.3373	0.3534	0.3456	0.3601	0.3369	0.3451
0.3373	0.3534	0.3456	0.3601	0.3369	0.3451	0.3448	0.3514	0.3366	0.3369
0.3456	0.3601	0.3539	0.3669	0.3448	0.3514	0.3526	0.3578	0.3440	0.3428
0.3463	0.3687	0.3552	0.3760	0.3456	0.3601	0.3539	0.3669	0.3448	0.3514
C5		C6		C7		C8		C9	
CIE x	CIE y	CIE x	CIE y	CIE x	CIE y	CIE x	CIE y	CIE x	CIE y
0.3448	0.3514	0.3366	0.3369	0.3440	0.3428	0.3381	0.3740	0.3470	0.3810
0.3440	0.3428	0.3364	0.3288	0.3433	0.3345	0.3376	0.3616	0.3463	0.3687
0.3514	0.3487	0.3433	0.3345	0.3500	0.3400	0.3463	0.3687	0.3552	0.3760
0.3526	0.3578	0.3440	0.3428	0.3514	0.3487	0.3470	0.3810	0.3572	0.3891

Color Bin Structure

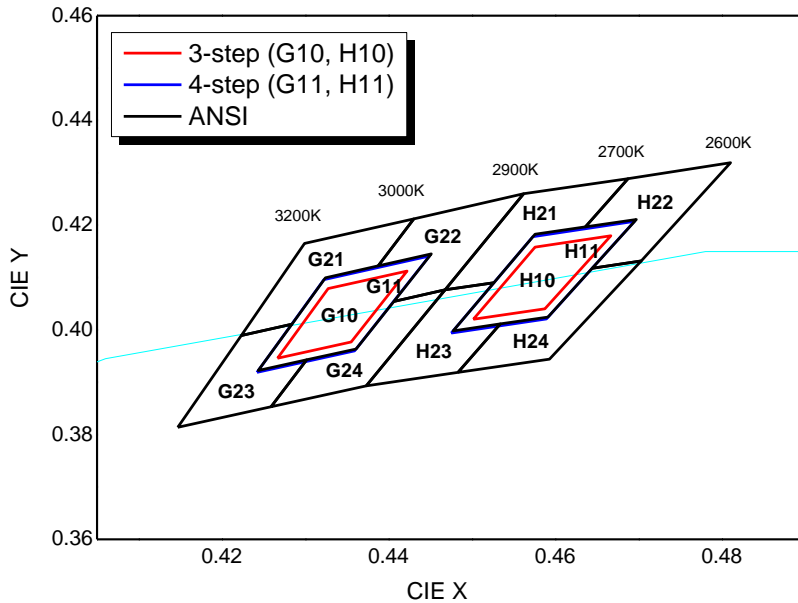
CIE Chromaticity Diagram (Warm white), Ta=25°C, IF=500mA

3-STEP				4-STEP			
G10		H10		G11		H11	
CIE x	CIE y	CIE x	CIE y	CIE x	CIE y	CIE x	CIE y
0.4267	0.3946	0.4502	0.4020	0.4242	0.3919	0.4475	0.3994
0.4328	0.4079	0.4576	0.4158	0.4322	0.4096	0.4573	0.4178
0.4422	0.4113	0.4667	0.4180	0.4449	0.4141	0.4695	0.4207
0.4355	0.3977	0.4588	0.4041	0.4359	0.396	0.4589	0.4021

ANSI							
G21		G22		G23		G24	
CIE x	CIE y	CIE x	CIE y	CIE x	CIE y	CIE x	CIE y
0.4223	0.3990	0.4406	0.4055	0.4147	0.3814	0.4259	0.3853
0.4299	0.4165	0.4451	0.4145	0.4223	0.3990	0.4302	0.3943
0.4430	0.4212	0.4387	0.4122	0.4284	0.4011	0.4361	0.3964
0.4387	0.4122	0.4430	0.4212	0.4243	0.3922	0.4406	0.4055
0.4324	0.4100	0.4562	0.4260	0.4302	0.3943	0.4468	0.4077
0.4284	0.4011	0.4468	0.4077	0.4259	0.3853	0.4373	0.3893
H21		H22		H23		H24	
CIE x	CIE y	CIE x	CIE y	CIE x	CIE y	CIE x	CIE y
0.4468	0.4077	0.4644	0.4118	0.4373	0.3893	0.4483	0.3919
0.4562	0.4260	0.4697	0.4211	0.4468	0.4077	0.4534	0.4012
0.4687	0.4289	0.4636	0.4197	0.4526	0.4090	0.4591	0.4025
0.4636	0.4197	0.4687	0.4289	0.4477	0.3998	0.4644	0.4118
0.4575	0.4182	0.4810	0.4319	0.4534	0.4012	0.4703	0.4132
0.4526	0.4090	0.4703	0.4132	0.4483	0.3919	0.4593	0.3944

Mechanical Dimensions

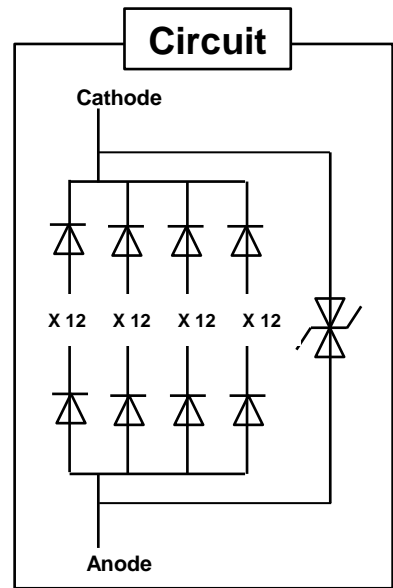
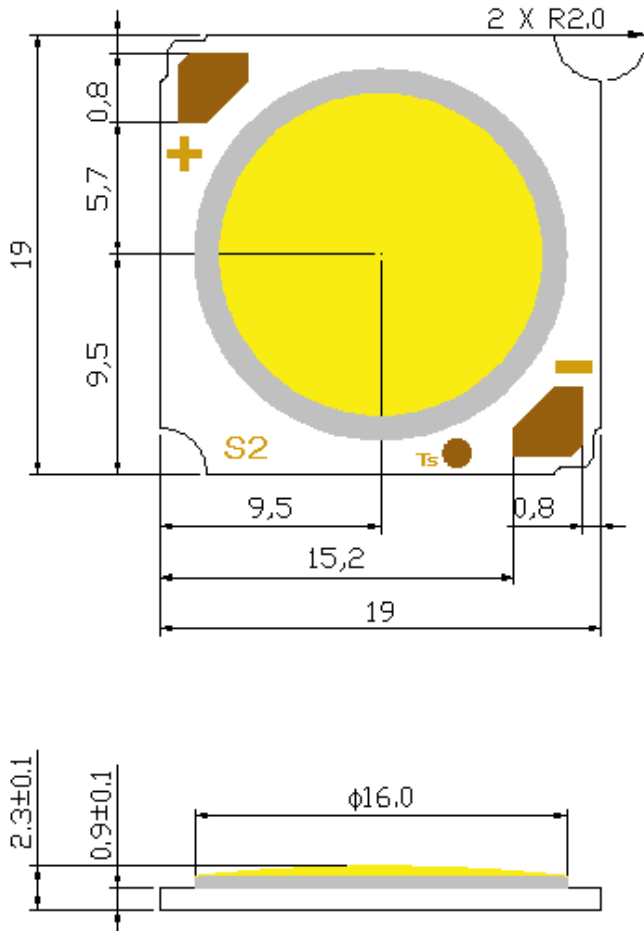

Notes :

1. All dimensions are in millimeters.
2. Scale : none
3. Undefined tolerance is ± 0.2 mm

Tray Packing Structure

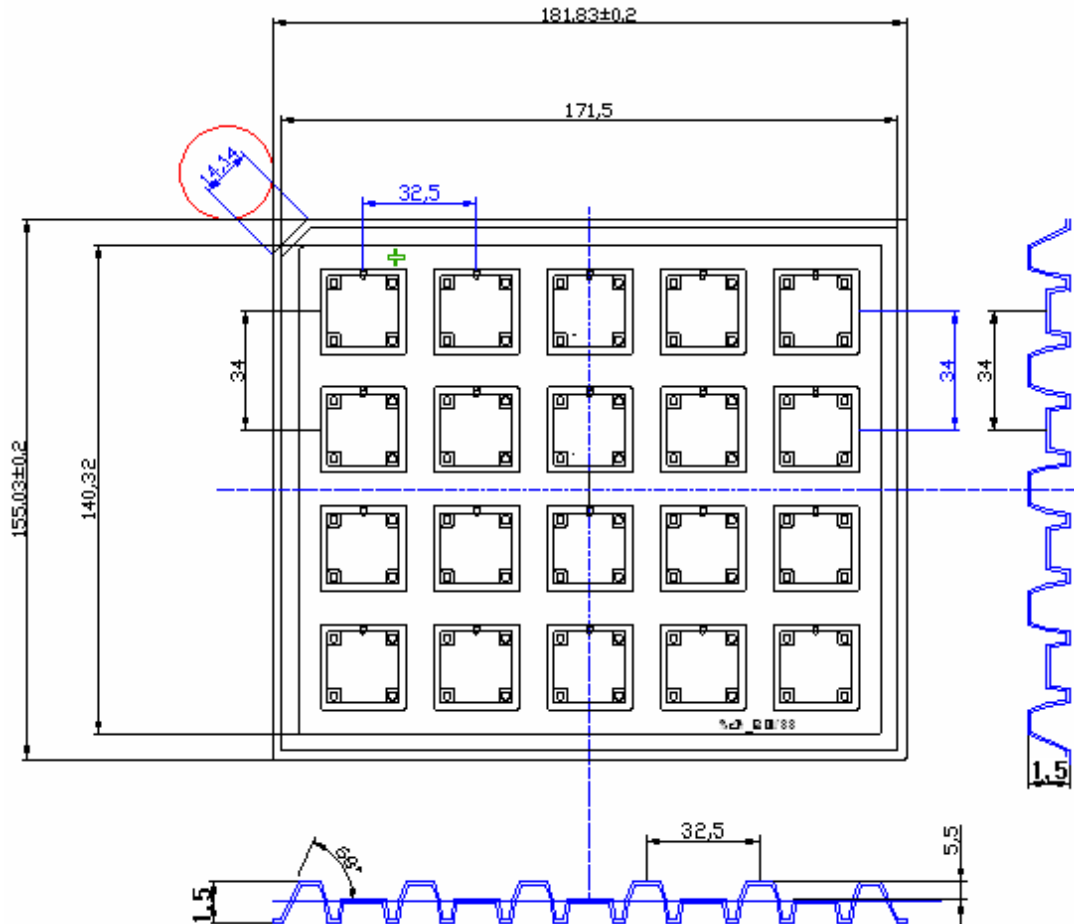
Notes :

1. Quantity : 20pcs/Tray
2. All dimensions are in millimeters (tolerance : ± 0.3)
3. Scale none

Packaging (Bag and box)

1. Moisture-proof bag ^{*1,2}

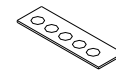
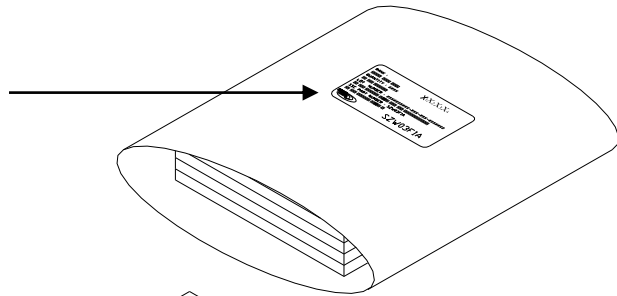
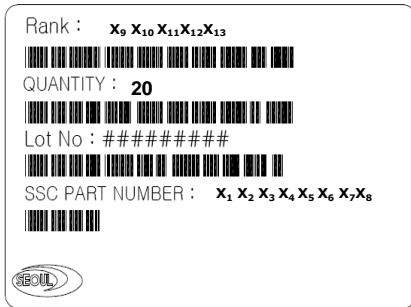

- Desiccant

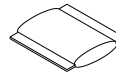

- Humidity Indicator

2. Outer Box Structure

TYPE	SIZE (mm)		
	⌀	⌀	⌀
7inch	245	220	142
	245	220	80

① SIDE

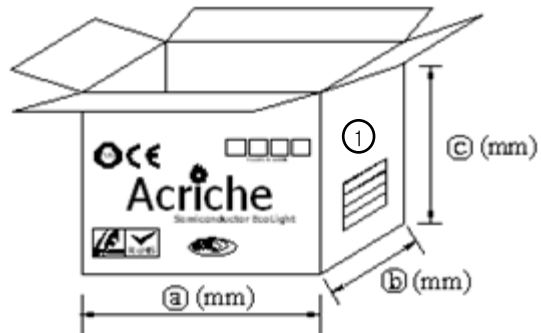
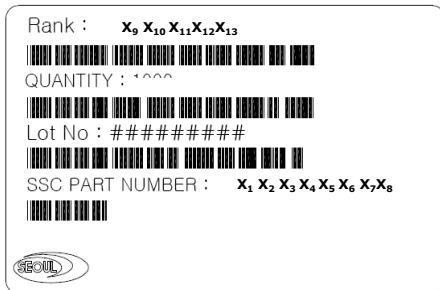

Notes :

- Heat Sealed after packing (Use Zipper Bag)
- Quantity : 1 Tray(20pcs) /Bag
: Max 2 Bag /Box(⌀80), Max 4 Bag /Box(⌀142)

Handling of Silicone Resin for LEDs

- (1) During processing, mechanical stress on the surface should be minimized as much as possible.

Sharp objects of all types should not be used to pierce the sealing compound.



- (2) In general, LEDs should only be handled from the side. By the way, this also applies to LEDs without a silicone sealant, since the surface can also become scratched.

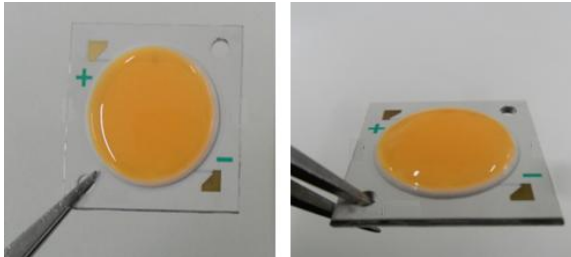

- (3) Silicone differs from materials conventionally used for the manufacturing of LEDs.

These conditions must be considered during the handling of such devices. Compared to standard encapsulants, silicone is generally softer, and the surface is more likely to attract dust. As mentioned previously, the increased sensitivity to dust requires special care during processing.

In cases where a minimal level of dirt and dust particles cannot be guaranteed, a suitable cleaning solution must be applied to the surface after the soldering of wire.

- (4) SSC suggests using isopropyl alcohol for cleaning. In case other solvents are used, it must be assured that these solvents do not dissolve the package or resin. Ultrasonic cleaning is not recommended. Ultrasonic cleaning may cause damage to the LED.
- (5) Please do not mold this product into another resin (epoxy, urethane, etc) and do not handle this product with acid or sulfur material in sealed space.
- (6) Avoid leaving fingerprints on silicone resin parts.

Precaution for Use

(1) Storage

To avoid the moisture penetration, we recommend storing Power LEDs in a dry box with a desiccant.

The recommended storage temperature range is 5C to 30C and a maximum humidity of 50%.

(2) Use Precaution after Opening the Packaging. Pay attention to the following:

a. Recommend conditions after opening the package

- Sealing

- Temperature : 5 ~ 40°C Humidity : less than RH30%

b. If the package has been opened more than 4 week or the color of the desiccant changes.

(3) For manual soldering

SSC recommends the soldering condition (ZC series product is not adaptable to reflow process)

a. Use lead-free soldering

b. Soldering should be implemented using a soldering equipment at temperature lower than 350°C.

c. Before proceeding the next step, product temperature must be stabilized at room temperature.

(4) Components should not be mounted on warped (non coplanar) portion of PCB.

(5) Radioactive exposure is not considered for the products listed here in.

(6) It is dangerous to drink the liquid or inhale the gas generated by such products when chemically disposed of.

(7) This device should not be used in any type of fluid such as water, oil, organic solvent and etc.

When washing is required, IPA (Isopropyl Alcohol) should be used.

(8) When the LEDs are in operation the maximum current should be decided after measuring the package temperature.

(9) LEDs must be stored properly to maintain the device. If the LEDs are stored for 3 months or more after being shipped from SSC, a sealed container with vacuum atmosphere should be used for storage.

(10) The appearance and specifications of the product may be modified for improvement without notice.

(11) Long time exposure of sun light or occasional UV exposure will cause silicone discoloration.

(12) Attaching LEDs, do not use adhesive that outgas organic vapor.

(13) The driving circuit must be designed to allow forward voltage only when it is ON or OFF. If the reverse voltage is applied to LED, migration can be generated resulting in LED damage.

(14) Please do not touch any of the circuit board, components or terminals with bare hands or metal while circuit is electrically active.

(15) VOCs (Volatile organic compounds) emitted from materials used in the construction of fixtures can penetrate silicone encapsulants of LEDs and discolor when exposed to heat and photonic energy. The result can be a significant loss of light output from the fixture. Knowledge of the properties of the materials selected to be used in the construction of fixtures can help prevent these issues.

Revision History

Revision	Date	Page	Remarks
1.0	2013-07-12	All	Initial release of preliminary data sheet applied

Published by

Seoul Semiconductor © 2013 All Rights Reserved.

Company Information

Seoul Semiconductor (SeoulSemicon.com) manufactures and packages a wide selection of light emitting diodes (LEDs) for the automotive, general illumination/lighting, appliance, signage and back lighting markets. The company is the world's fifth largest LED supplier, holding more than 10,000 patents globally, while offering a wide range of LED technology and production capacity in areas such as "nPola", deep UV LEDs, "Acrich", the world's first commercially produced AC LED, and "Acrich MJT - Multi-Junction Technology" a proprietary family of high-voltage LEDs. The company's broad product portfolio includes a wide array of package and device choices such as Acrich, high-brightness LEDs, mid-power LEDs, side-view LEDs, through-hole type LED lamps, custom displays, and sensors. The company is vertically integrated from epitaxial growth and chip manufacture in its fully owned subsidiary, Seoul Optodevice, through packaged LEDs and LED modules in three Seoul Semiconductor manufacturing facilities. Seoul Optodevice also manufactures a wide range of unique deep-UV wavelength devices.

Legal Disclaimer

Information in this document is provided in connection with Seoul Semiconductor products. With respect to any examples or hints given herein, any typical values stated herein and/or any information regarding the application of the device, Seoul Semiconductor hereby disclaims any and all warranties and liabilities of any kind, including without limitation, warranties of non-infringement of intellectual property rights of any third party. The appearance and specifications of the product can be changed to improve the quality and/or performance without notice.