

ANSMANN reserves the right to make changes to the product described in this drawing without notice. The right to make changes to the product described in this drawing without notice. The right to make changes to the product described in this drawing without notice.

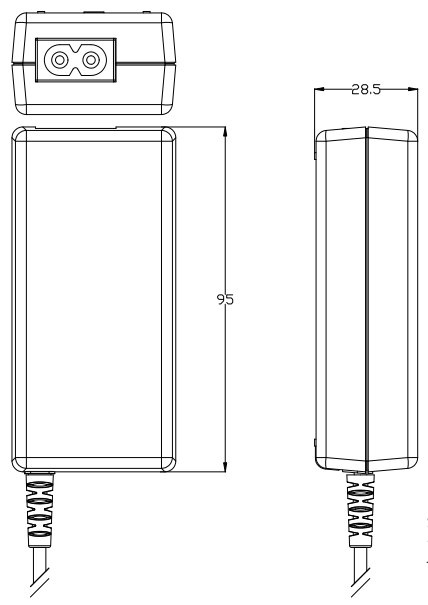

Spannungseinstellung mit mini Stecker (jumper)/  
voltage adjust with mini plug (jumper)

Rundleitung schwarz 30cm ±2cm lang geschirmt/  
round cable black 30cm ±2cm long with shield

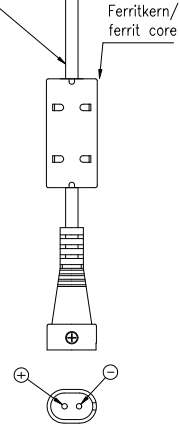

Ferritkern/  
ferrit core

Technische Daten/ technical data	:	Tischnetzgerät/ desktop power supply
Eingangsspannung/ input voltage	:	100–240VAC ±10% / 50/60Hz switch-mode
Eingangs-Schutz/ primary electrical protection	:	Glassicherung T3,15A glas fuse
Leistungsaufnahme im Leerlauf/ stand-by power consumption	:	≅ 0.3W
Nenn-Leistungsaufnahme/ Rated Power	:	ca./ approx. 30W
Ableitstrom/ Leakage current	:	< 250uA
Ausgangsspannung im Leerlauf/ no load output voltage	:	max. 10% nom.
Ausgangsspannung/ output voltage	:	5 6 7 8 9 10 11 12 V DC ±10%
Ausgangsstrom/ output current	:	4 3.5 3.3 3.2 3.1 2.8 2.6 2.5 bei/at 100–240V
Brummspannung/ ripple voltage	:	< 300mV
Ausgangs-Schutz/ secondary electrical protection	:	gegen Kurzschluß/ gegen Überlast/ against short circuit against overload
Spannungsfestigkeit/ electric strength	:	4 kV Eingang/Ausgang primary/secondary
Schutzklasse/ protection class	:	II
Betriebstemperatur/ operating temperature	:	0°C...+40°C
Lagertemperatur/ storage temperature	:	-25°C...+70°C

Nettogewicht/ net weight	:	260g
Gehäuse/ case	:	Tischgehäuse, schwarz, Typ/ 0055-L desktop housing, black, type
Gehäusematerial/ case material	:	UL94V-0
Leiterplattenmaterial/ pcb material	:	CEM1
Schutzart/ case protection	:	IP 40
Typenschild Vorderseite/ ratingplate front	:	---
Typenschild Rückseite/ ratingplate back	:	silberner Aufkleber mit schwarzer Bedruckung/ silver label with black printing/
Anleitungen/ instructions	:	yes
Approbationen/ approvals	:	CE, eTlus, GS
Normen/ standards	:	IEC/EN60950
Betriebsanzeige/ operating indicator	:	LED rot leuchtet bei Netzkontakt/ LED red lights if mains is connected

M/Scale: 2:1

**ANSMANN**  
MODEL: 0055A-L Desktop Power Supply  
Input: AC 100-240V 600mA 50Hz/60Hz  
Output: selected by Jumper

Output Voltage	5V	6V	7V	8V	9V	10V	11V	12V
Line Output current	4A	3.5A	3.3A	3.2A	3.1A	2.8A	2.6A	2.5A

Information Technology Equipment - Safety - Part 1: General Requirements  
Information Technology Equipment - Safety - Part 2: Additional Safety Requirements for Information Technology Equipment  
Information Technology Equipment - Safety - Part 3: Additional Safety Requirements for Information Technology Equipment  
Information Technology Equipment - Safety - Part 4: Additional Safety Requirements for Information Technology Equipment  
Information Technology Equipment - Safety - Part 5: Additional Safety Requirements for Information Technology Equipment  
Information Technology Equipment - Safety - Part 6: Additional Safety Requirements for Information Technology Equipment  
Information Technology Equipment - Safety - Part 7: Additional Safety Requirements for Information Technology Equipment  
Information Technology Equipment - Safety - Part 8: Additional Safety Requirements for Information Technology Equipment  
Information Technology Equipment - Safety - Part 9: Additional Safety Requirements for Information Technology Equipment  
Information Technology Equipment - Safety - Part 10: Additional Safety Requirements for Information Technology Equipment

CE Mark 1  
RoHS  
REACH  
Made in China  
part. no.: 2102-0005  
Indoor use only

NetzadapterEU/UK  
AC AdaptorEU/UK  
part. no.: 10950063/01

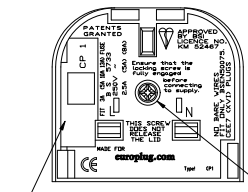

Sicherung 3A/  
fuse 3A

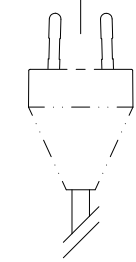

Schraube zur Befestigung des Euro-Steckers  
screw for fix the european plug

Netzleitung Euro/main lead  
Länge/length 1,2m

Ferritkern/  
ferrit core

Hohlstecker / hollow plug  
Ø1.4xØ6x12mm with inner pin



Hohlstecker / hollow plug  
Ø1.7xØ4.1x11.5mm



Hohlstecker / hollow plug  
Ø1.1xØ5.1x12mm with inner pin



Hohlstecker / hollow plug  
Ø1.35xØ3.5x12mm

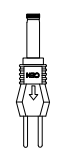

Hohlstecker / hollow plug  
Ø1.7xØ4.75x11mm



Hohlstecker / hollow plug  
Ø2.5xØ5.5x13.3mm

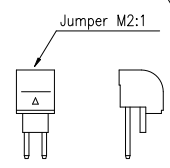

Jumper M2:1

Hohlstecker / hollow plug  
Ø3xØ6.3x12mm

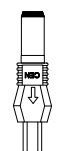

Hohlstecker / hollow plug  
Ø2.1xØ5.5x12mm

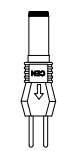

xxV Ausgangsspannungswert 5–12V/  
output voltage value 5–12V

Verwendungsbereich/Application range für Anfrage/for inquiry AN-IS-2011-	Zul. Abweichung/ Allowable deviation	Oberfläche/ Surface	Maßstab/Scale 1:1	Gewicht/Weight
			Werkstoff/Work material, Modell-Nr. XXX	
	2011 Datum/Date Name	JE	Zeichnungsname/Drawing name	
	Bearbeitet/ Drawn by	26.09.	Tischnetzgerät/ desktop power supply	
			5V...12V/ 4A...2.5A	
V0 label color changed	10.01.12 JE		Zeichnungsnummer/Drawing number	Blatt/ Sheet
V0 part. no. corrected	05.01.12 JE		2102-0005	1
Version Änderung/Change	Datum/Date Name	Ursprung/Origin Proj. OEM-010-11-DE	Ersatz für/Replaced by	Ersatz durch/Replacement through