

# Quad 16-/12-Bit Rail-to-Rail DACs with 10ppm/°C Max Reference

## FEATURES

- Precision Reference 10ppm/°C Max
- Maximum INL Error:  $\pm 4$ LSB at 16-Bits
- Low  $\pm 2$ mV (Max) Offset Error
- Guaranteed Monotonic Over Temperature
- Selectable Internal or External Reference
- 2.7V to 5.5V Supply Range (LTC2654-L)
- Integrated Reference Buffers
- Ultralow Crosstalk Between DACs ( $< 3$ nV•s)
- Power-on-Reset to Zero-Scale/Mid-Scale
- Asynchronous DAC Update Pin
- Tiny 20-Lead 4mm  $\times$  4mm QFN and 16-Lead Narrow SSOP Packages

## APPLICATIONS

- Mobile Communications
- Process Control and Industrial Automation
- Instrumentation
- Automatic Test Equipment
- Automotive

## DESCRIPTION

The LTC<sup>®</sup>2654 is a family of quad 16-/12-bit rail-to-rail DACs with integrated 10ppm/°C maximum reference. The DACs have built-in high performance, rail-to-rail, output buffers and are guaranteed monotonic. The LTC2654-L has a full-scale output of 2.5V with the integrated reference and operates from a single 2.7V to 5.5V supply. The LTC2654-H has a full-scale output of 4.096V with the integrated reference and operates from a 4.5V to 5.5V supply. Each DAC can also operate with an external reference, which sets the full-scale output to 2 times the external reference voltage.

These DACs communicate via a SPI/MICROWIRE compatible 4-wire serial interface which operates at clock rates up to 50MHz. The LTC2654 incorporates a power-on reset circuit that is controlled by the PORSEL pin. If PORSEL is tied to GND the DACs reset to zero-scale. If PORSEL is tied to  $V_{CC}$ , the DACs reset to mid-scale.

LT, LTC, LTM, Linear Technology and the Linear logo are registered trademarks of Linear Technology Corporation. All other trademarks are the property of their respective owners. Protected by U.S. Patents, including 5396245, 6891433 and patent pending.

## BLOCK DIAGRAM

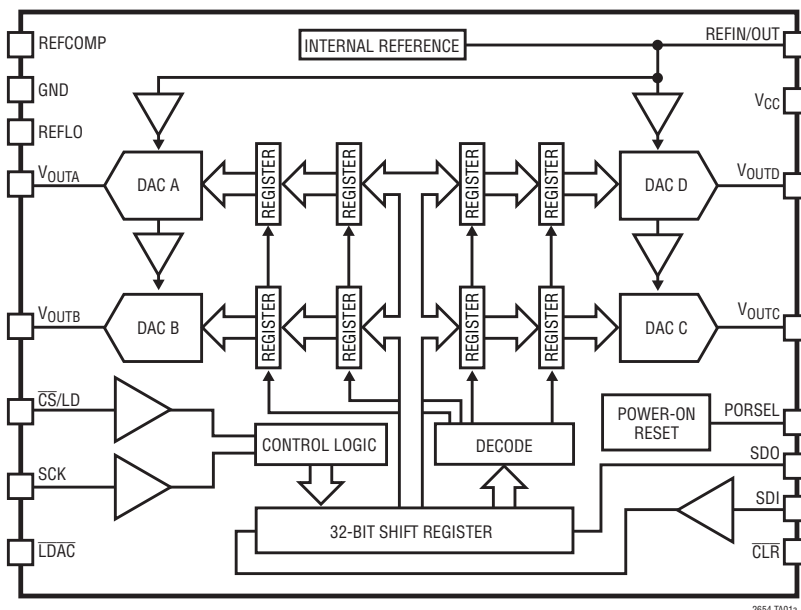

**INL Curve**

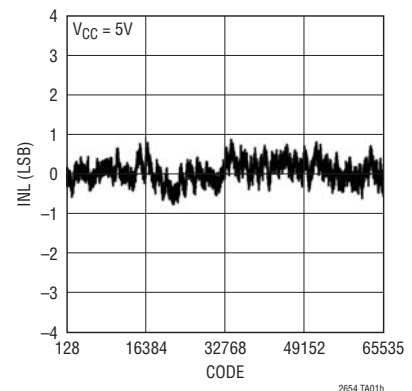

# LTC2654

## ABSOLUTE MAXIMUM RATINGS (Notes 1, 2)

Supply Voltage ( $V_{CC}$ ) ..... -0.3V to 6V  
 $\overline{CS}/LD$ , SCK, SDI,  $\overline{LDAC}$ ,  $\overline{CLR}$ , REFLO ..... -0.3V to 6V  
 $V_{OUTA-D}$  ..... -0.3V to Min ( $V_{CC} + 0.3V$ , 6V)  
 REFIN/OUT, REFCOMP ..... -0.3V to Min ( $V_{CC} + 0.3V$ , 6V)  
 PORSEL, SDO ..... -0.3V to Min ( $V_{CC} + 0.3V$ , 6V)  
 Operating Temperature Range  
 LTC2654C ..... 0°C to 70°C  
 LTC2654I ..... -40°C to 85°C

Maximum Junction Temperature ..... 150°C  
 Storage Temperature Range ..... -65°C to 150°C  
 Lead Temperature  
 (Soldering GN-Package, 10 sec) ..... 300°C

## PIN CONFIGURATION

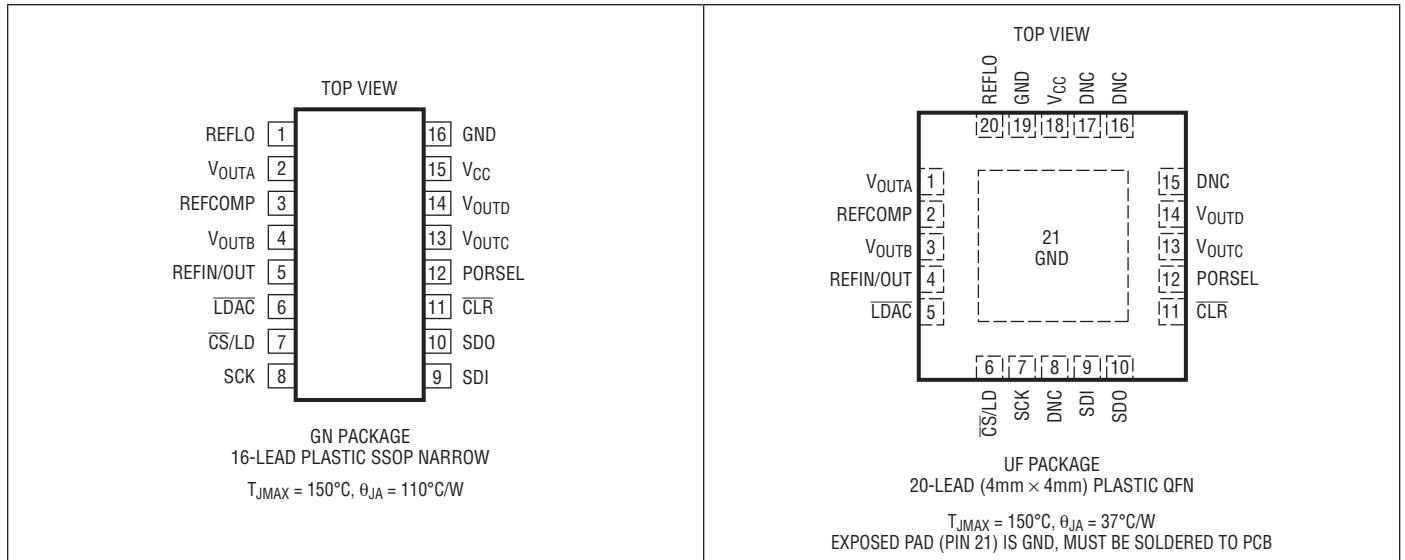

## PRODUCT SELECTOR GUIDE



Consult LTC Marketing for information on non-standard lead based finish parts. Consult LTC Marketing for parts specified with wider operating temperature ranges.

For more information on lead free part marking, go to: <http://www.linear.com/leadfree/>

For more information on tape and reel specifications, go to: <http://www.linear.com/tapeandreeel/>

## ORDER INFORMATION

| LEAD FREE FINISH    | TAPE AND REEL         | PART MARKING* | PACKAGE DESCRIPTION             | TEMPERATURE RANGE | MAXIMUM INL |
|---------------------|-----------------------|---------------|---------------------------------|-------------------|-------------|
| LTC2654BCGN-L16#PBF | LTC2654BCGN-L16#TRPBF | 654L16        | 16-Lead Narrow SSOP             | 0°C to 70°C       | ±4          |
| LTC2654BIGN-L16#PBF | LTC2654BIGN-L16#TRPBF | 654L16        | 16-Lead Narrow SSOP             | -40°C to 85°C     | ±4          |
| LTC2654BCUF-L16#PBF | LTC2654BCUF-L16#TRPBF | 54L16         | 20-Lead (4mm × 4mm) Plastic QFN | 0°C to 70°C       | ±4          |
| LTC2654BIUF-L16#PBF | LTC2654BIUF-L16#TRPBF | 54L16         | 20-Lead (4mm × 4mm) Plastic QFN | -40°C to 85°C     | ±4          |
| LTC2654BCGN-H16#PBF | LTC2654BCGN-H16#TRPBF | 654H16        | 16-Lead Narrow SSOP             | 0°C to 70°C       | ±4          |
| LTC2654BIGN-H16#PBF | LTC2654BIGN-H16#TRPBF | 654H16        | 16-Lead Narrow SSOP             | -40°C to 85°C     | ±4          |
| LTC2654BCUF-H16#PBF | LTC2654BCUF-H16#TRPBF | 54H16         | 20-Lead (4mm × 4mm) Plastic QFN | 0°C to 70°C       | ±4          |
| LTC2654BIUF-H16#PBF | LTC2654BIUF-H16#TRPBF | 54H16         | 20-Lead (4mm × 4mm) Plastic QFN | -40°C to 85°C     | ±4          |
| LTC2654CGN-L12#PBF  | LTC2654CGN-L12#TRPBF  | 654L12        | 16-Lead Narrow SSOP             | 0°C to 70°C       | ±1          |
| LTC2654IGN-L12#PBF  | LTC2654IGN-L12#TRPBF  | 654L12        | 16-Lead Narrow SSOP             | -40°C to 85°C     | ±1          |
| LTC2654CUF-L12#PBF  | LTC2654CUF-L12#TRPBF  | 54L12         | 20-Lead (4mm × 4mm) Plastic QFN | 0°C to 70°C       | ±1          |
| LTC2654IUF-L12#PBF  | LTC2654IUF-L12#TRPBF  | 54L12         | 20-Lead (4mm × 4mm) Plastic QFN | -40°C to 85°C     | ±1          |
| LTC2654CGN-H12#PBF  | LTC2654CGN-H12#TRPBF  | 654H12        | 16-Lead Narrow SSOP             | 0°C to 70°C       | ±1          |
| LTC2654IGN-H12#PBF  | LTC2654IGN-H12#TRPBF  | 654H12        | 16-Lead Narrow SSOP             | -40°C to 85°C     | ±1          |
| LTC2654CUF-H12#PBF  | LTC2654CUF-H12#TRPBF  | 54H12         | 20-Lead (4mm × 4mm) Plastic QFN | 0°C to 70°C       | ±1          |
| LTC2654IUF-H12#PBF  | LTC2654IUF-H12#TRPBF  | 54H12         | 20-Lead (4mm × 4mm) Plastic QFN | -40°C to 85°C     | ±1          |

Consult LTC Marketing for parts specified with wider operating temperature ranges. \*The temperature grade is identified by a label on the shipping container. Consult LTC Marketing for information on non-standard lead based finish parts.

For more information on lead free part marking, go to: <http://www.linear.com/leadfree/>

For more information on tape and reel specifications, go to: <http://www.linear.com/tapeandreeel/>

## ELECTRICAL CHARACTERISTICS

The ● denotes the specifications which apply over the full operating temperature range, otherwise specifications are at  $T_A = 25^\circ\text{C}$ .  $V_{CC} = 2.7\text{V}$  to  $5.5\text{V}$ ,  $V_{OUT}$  unloaded unless otherwise specified.

### LTC2654B-L16/LTC2654-L12 (Internal Reference = 1.25V)

| SYMBOL                | PARAMETER                        | CONDITIONS  | LTC2654-12 |       |       | LTC2654B-16 |      |     | UNITS                        |
|-----------------------|----------------------------------|---|------------|-------|-------|-------------|------|-----|------------------------------|
|                       |                                  |   | MIN        | TYP   | MAX   | MIN         | TYP  | MAX |                              |
| <b>DC Performance</b> |                                  |   |            |       |       |             |      |     |                              |
|                       | Resolution                       |   | ●          | 12    |       | 16          |      |     | Bits                         |
|                       | Monotonicity                     | (Note 3)  | ●          | 12    |       | 16          |      |     | Bits                         |
| DNL                   | Differential Nonlinearity        | (Note 3)  | ●          | ±0.1  | ±0.5  | ±0.3        | ±1   |     | LSB                          |
| INL                   | Integral Nonlinearity            | $V_{CC} = 5.5\text{V}$ , $V_{REF} = 2.5\text{V}$ (Note 3)   | ●          | ±0.5  | ±1    | ±2          | ±4   |     | LSB                          |
|                       | Load Regulation                  | $V_{CC} = 5\text{V} \pm 10\%$ , Integral Reference, Mid-Scale, $-15\text{mA} \leq I_{OUT} \leq 15\text{mA}$   | ●          | 0.04  | 0.125 | 0.6         | 2    |     | LSB/mA                       |
|                       |                                  | $V_{CC} = 3\text{V} \pm 10\%$ , Integral Reference, Mid-Scale, $-7.5\text{mA} \leq I_{OUT} \leq 7.5\text{mA}$ | ●          | 0.06  | 0.25  | 1           | 4    |     | LSB/mA                       |
| ZSE                   | Zero-Scale Error                 |   | ●          | 1     | 3     | 1           | 3    |     | mV                           |
| $V_{OS}$              | Offset Error                     | (Note 4)  | ●          | ±1    | ±2    | ±1          | ±2   |     | mV                           |
|                       | $V_{OS}$ Temperature Coefficient |   |            | 5     |       | 5           |      |     | $\mu\text{V}/^\circ\text{C}$ |
| GE                    | Gain Error                       | (Note 13)   | ●          | ±0.02 | ±0.1  | ±0.02       | ±0.1 |     | %FSR                         |
|                       | Gain Temperature Coefficient     |   |            | 1     |       | 1           |      |     | ppm/ $^\circ\text{C}$        |

## ELECTRICAL CHARACTERISTICS

The ● denotes the specifications which apply over the full operating temperature range, otherwise specifications are at  $T_A = 25^\circ\text{C}$ .  $V_{CC} = 2.7\text{V}$  to  $5.5\text{V}$ ,  $V_{OUT}$  unloaded unless otherwise specified.

| SYMBOL    | PARAMETER                    | CONDITIONS  | MIN | TYP                       | MAX  | UNITS                   |
|-----------|------------------------------|---|-----|---------------------------|------|-------------------------|
| $V_{OUT}$ | DAC Output Span              | Internal Reference  |     | 0 to 2.5                  |      | V                       |
|           |                              | External Reference = $V_{EXTREF}$   |     | 0 to $2 \cdot V_{EXTREF}$ |      | V                       |
| PSR       | Power Supply Rejection       | $V_{CC} \pm 10\%$   |     | -80                       |      | dB                      |
| $R_{OUT}$ | DC Output Impedance          | $V_{CC} = 5\text{V} \pm 10\%$ , Internal Reference, Mid-Scale, $-15\text{mA} \leq I_{OUT} \leq 15\text{mA}$   | ●   | 0.04                      | 0.15 | $\Omega$                |
|           |                              | $V_{CC} = 3\text{V} \pm 10\%$ , Internal Reference, Mid-Scale, $-7.5\text{mA} \leq I_{OUT} \leq 7.5\text{mA}$   | ●   | 0.04                      | 0.15 | $\Omega$                |
|           | DC Crosstalk                 | Due to Full-Scale Output Change (Note 5)  |     | $\pm 1.5$                 |      | $\mu\text{V}$           |
|           |                              | Due to Load Current Change (Note 5)   |     | $\pm 2$                   |      | $\mu\text{V}/\text{mA}$ |
|           |                              | Due to Powering Down (per Channel) (Note 5)   |     | $\pm 1$                   |      | $\mu\text{V}$           |
| $I_{SC}$  | Short-Circuit Output Current | $V_{CC} = 5.5\text{V}$ $V_{EXTREF} = 2.8\text{V}$ (Note 6)<br>Code: Zero-Scale; Forcing Output to $V_{CC}$ (Note 6)<br>Code: Full-Scale; Forcing Output to GND (Note 6) | ●   | 20                        | 65   | mA                      |
|           |                              |   | ●   | 20                        | 65   | mA                      |
|           |                              | $V_{CC} = 2.7\text{V}$ $V_{EXTREF} = 1.4\text{V}$<br>Code: Zero-Scale; Forcing Output to $V_{CC}$<br>Code: Full-Scale; Forcing Output to GND                            | ●   | 10                        | 45   | mA                      |
|           |                              |   | ●   | 10                        | 45   | mA                      |

### LTC2654B-L16/ LTC2654-L12 (Internal Reference = 1.25V)

| SYMBOL           | PARAMETER                              | CONDITIONS  | MIN   | TYP     | MAX        | UNITS                  |
|------------------|--|---|-------|---------|------------|------------------------|
| <b>Reference</b> |  |   |       |         |            |                        |
|                  | Reference Output Voltage               |   | 1.248 | 1.25    | 1.252      | V                      |
|                  | Reference Temperature Coefficient      | (Note 7)  |       | $\pm 2$ | $\pm 10$   | ppm/ $^\circ\text{C}$  |
|                  | Reference Line Regulation              | $V_{CC} \pm 10\%$   |       | -80     |            | dB                     |
|                  | Reference Short-Circuit Current        | $V_{CC} = 5.5\text{V}$ , Forcing Output to GND  | ●     | 3       | 5          | mA                     |
|                  | Refcomp Pin Short-Circuit Current      | $V_{CC} = 5.5\text{V}$ , Forcing Output to GND  | ●     | 60      | 200        | $\mu\text{A}$          |
|                  | Reference Load Regulation              | $V_{CC} = 3\text{V} \pm 10\%$ or $5\text{V} \pm 10\%$ , $I_{OUT} = 100\mu\text{A}$ Sourcing |       | 40      |            | mV/mA                  |
|                  | Reference Output Voltage Noise Density | $C_{REFCOMP} = C_{REFIN/OUT} = 0.1\mu\text{F}$ , at $f = 1\text{kHz}$                       |       | 30      |            | nV/ $\sqrt{\text{Hz}}$ |
|                  | Reference Input Range                  | External Reference Mode (Note 13)   | ●     | 0.5     | $V_{CC}/2$ | V                      |
|                  | Reference Input Current                |   | ●     | 0.001   | 1          | $\mu\text{A}$          |
|                  | Reference Input Capacitance            | (Note 9)  | ●     | 20      |            | pF                     |

### Power Supply

|          |                                 |  |   |     |     |               |
|----------|---------------------------------|--|---|-----|-----|---------------|
| $V_{CC}$ | Positive Supply Voltage         | For Specified Performance                              | ● | 2.7 | 5.5 | V             |
| $I_{CC}$ | Supply Current                  | $V_{CC} = 5\text{V}$ , Internal Reference On (Note 8)  | ● | 1.7 | 2.5 | mA            |
|          |                                 | $V_{CC} = 5\text{V}$ , Internal Reference Off (Note 8) | ● | 1.3 | 2   | mA            |
|          |                                 | $V_{CC} = 3\text{V}$ , Internal Reference On (Note 8)  | ● | 1.6 | 2.2 | mA            |
|          |                                 | $V_{CC} = 3\text{V}$ , Internal Reference Off (Note 8) | ● | 1.2 | 1.7 | mA            |
| $I_{SD}$ | Supply Current in Shutdown Mode | $V_{CC} = 5\text{V}$ (Note 8)                          | ● |     | 3   | $\mu\text{A}$ |

### Digital I/O

|          |                             |   |   |                |     |   |
|----------|-----------------------------|---|---|----------------|-----|---|
| $V_{IH}$ | Digital Input High Voltage  | $V_{CC} = 3.6\text{V}$ to $5.5\text{V}$ | ● | 2.4            |     | V |
|          |                             | $V_{CC} = 2.7\text{V}$ to $3.6\text{V}$ | ● | 2.0            |     | V |
| $V_{IL}$ | Digital Input Low Voltage   | $V_{CC} = 4.5\text{V}$ to $5.5\text{V}$ | ● |                | 0.8 | V |
|          |                             | $V_{CC} = 2.7\text{V}$ to $4.5\text{V}$ | ● |                | 0.6 | V |
| $V_{OH}$ | Digital Output High Voltage | Load Current = $-100\mu\text{A}$        | ● | $V_{CC} - 0.4$ |     | V |
| $V_{OL}$ | Digital Output Low Voltage  | Load Current = $100\mu\text{A}$         | ● |                | 0.4 | V |

# LTC2654

## ELECTRICAL CHARACTERISTICS

The ● denotes the specifications which apply over the full operating temperature range, otherwise specifications are at  $T_A = 25^\circ\text{C}$ .  $V_{CC} = 2.7\text{V}$  to  $5.5\text{V}$ ,  $V_{OUT}$  unloaded unless otherwise specified.

### LTC2654B-L16/ LTC2654-L12 (Internal Reference = 1.25V)

| SYMBOL   | PARAMETER                 | CONDITIONS                       | MIN | TYP | MAX     | UNITS         |
|----------|---------------------------|----------------------------------|-----|-----|---------|---------------|
| $I_{LK}$ | Digital Input Leakage     | $V_{IN} = \text{GND to } V_{CC}$ | ●   |     | $\pm 1$ | $\mu\text{A}$ |
| $C_{IN}$ | Digital Input Capacitance | (Note 9)                         | ●   |     | 8       | pF            |

### AC Performance

|       |                              |  |  |      |                              |
|-------|------------------------------|--|--|------|------------------------------|
| $t_S$ | Settling Time                | $\pm 0.024\%$ ( $\pm 1\text{LSB}$ at 12 Bits) (Note 10)  |  | 4.2  | $\mu\text{s}$                |
|       |                              | $\pm 0.0015\%$ ( $\pm 1\text{LSB}$ at 16 Bits) (Note 10) |  | 8.9  | $\mu\text{s}$                |
|       | Settling Time for 1LSB Step  | $\pm 0.024\%$ ( $\pm 1\text{LSB}$ at 12 Bits)            |  | 2.2  | $\mu\text{s}$                |
|       |                              | $\pm 0.0015\%$ ( $\pm 1\text{LSB}$ at 16 Bits)           |  | 4.9  | $\mu\text{s}$                |
|       | Voltage Output Slew Rate     |  |  | 1.8  | $\text{V}/\mu\text{s}$       |
|       | Capacitive Load Driving      |  |  | 1000 | pF                           |
|       | Glitch Impulse               | At Mid-Scale Transition (Note 11)                        |  | 3    | $\text{nV}\cdot\text{s}$     |
|       | DAC-to-DAC Crosstalk         | Due to Full-Scale Output Change (Note 12)                |  | 3    | $\text{nV}\cdot\text{s}$     |
|       | Multiplying Bandwidth        |  |  | 150  | kHz                          |
| $e_n$ | Output Voltage Noise Density | At $f = 1\text{kHz}$                                     |  | 85   | $\text{nV}/\sqrt{\text{Hz}}$ |
|       |                              | At $f = 10\text{kHz}$                                    |  | 80   | $\text{nV}/\sqrt{\text{Hz}}$ |
|       | Output Voltage Noise         | 0.1Hz to 10Hz, Internal Reference                        |  | 8    | $\mu\text{V}_{P-P}$          |
|       |                              | 0.1Hz to 200kHz, Internal Reference                      |  | 400  | $\mu\text{V}_{P-P}$          |

The ● denotes the specifications which apply over the full operating temperature range, otherwise specifications are at  $T_A = 25^\circ\text{C}$ .  $V_{CC} = 4.5\text{V}$  to  $5.5\text{V}$ ,  $V_{OUT}$  unloaded unless otherwise specified.

### LTC2654B-H16/LTC2654-H12 (Internal Reference = 2.048V)

| SYMBOL   | PARAMETER                        | CONDITIONS  | LTC2654-12 |            |           | LTC2654B-16 |           |                              | UNITS |
|----------|----------------------------------|---|------------|------------|-----------|-------------|-----------|------------------------------|-------|
|          |                                  |   | MIN        | TYP        | MAX       | MIN         | TYP       | MAX                          |       |
|          | Resolution                       |   | ●          | 12         |           | 16          |           | Bits                         |       |
|          | Monotonicity                     | (Note 3)  | ●          | 12         |           | 16          |           | Bits                         |       |
| DNL      | Differential Nonlinearity        | (Note 3)  | ●          | $\pm 0.1$  | $\pm 0.5$ | $\pm 0.3$   | $\pm 1$   | LSB                          |       |
| INL      | Integral Nonlinearity (Note 3)   | $V_{CC} = 5.5\text{V}$ , $V_{REF} = 2.5\text{V}$  | ●          | $\pm 0.5$  | $\pm 1$   | $\pm 2$     | $\pm 4$   | LSB                          |       |
|          | Load Regulation                  | $V_{CC} = 5\text{V} \pm 10\%$ , Integral Reference, Mid-Scale, $-15\text{mA} \leq I_{OUT} \leq 15\text{mA}$ | ●          | 0.04       | 0.125     | 0.6         | 2         | LSB/mA                       |       |
| ZSE      | Zero-Scale Error                 |   | ●          | 1          | 3         | 1           | 3         | mV                           |       |
| $V_{OS}$ | Offset Error                     | (Note 4)  | ●          | $\pm 1$    | $\pm 2$   | $\pm 1$     | $\pm 2$   | mV                           |       |
|          | $V_{OS}$ Temperature Coefficient |   |            | 5          |           | 5           |           | $\mu\text{V}/^\circ\text{C}$ |       |
| GE       | Gain Error                       | (Note 13)   | ●          | $\pm 0.02$ | $\pm 0.1$ | $\pm 0.02$  | $\pm 0.1$ | %FSR                         |       |
|          | Gain Temperature Coefficient     |   |            | 1          |           | 1           |           | ppm/ $^\circ\text{C}$        |       |

| SYMBOL    | PARAMETER              | CONDITIONS  | MIN | TYP                                     | MAX  | UNITS    |
|-----------|------------------------|---|-----|---|------|----------|
| $V_{OUT}$ | DAC Output Span        | Internal Reference<br>External Reference = $V_{EXTREF}$   |     | 0 to 4.096<br>0 to $2 \cdot V_{EXTREF}$ |      | V<br>V   |
| PSR       | Power Supply Rejection | $V_{CC} \pm 10\%$   |     | -80                                     |      | dB       |
| $R_{OUT}$ | DC Output Impedance    | $V_{CC} = 5\text{V} \pm 10\%$ , Internal Reference, Mid-Scale, $-15\text{mA} \leq I_{OUT} \leq 15\text{mA}$ | ●   | 0.04                                    | 0.15 | $\Omega$ |

2654f

## ELECTRICAL CHARACTERISTICS

The ● denotes the specifications which apply over the full operating temperature range, otherwise specifications are at  $T_A = 25^\circ\text{C}$ .  $V_{CC} = 4.5\text{V}$  to  $5.5\text{V}$ ,  $V_{OUT}$  unloaded unless otherwise specified.

| SYMBOL   | PARAMETER                    | CONDITIONS  | MIN      | TYP                             | MAX      | UNITS   |
|----------|------------------------------|---|----------|---------------------------------|----------|---|
|          | DC Crosstalk                 | Due to Full-Scale Output Change (Note 5)<br>Due to Load Current Change (Note 5)<br>Due to Powering Down (per Channel) (Note 5)  |          | $\pm 1.5$<br>$\pm 2$<br>$\pm 1$ |          | $\mu\text{V}$<br>$\mu\text{V}/\text{mA}$<br>$\mu\text{V}$ |
| $I_{SC}$ | Short-Circuit Output Current | $V_{CC} = 5.5\text{V}$ , $V_{EXTREF} = 2.8\text{V}$ (Note 6)<br>Code: Zero-Scale; Forcing Output to $V_{CC}$ (Note 6) ●<br>Code: Full-Scale; Forcing Output to GND (Note 6) ● | 20<br>20 |                                 | 65<br>65 | mA<br>mA  |

### LTC2654B-H16/ LTC2654-H12 (Internal Reference = 2.048V)

| SYMBOL           | PARAMETER                              | CONDITIONS  | MIN   | TYP     | MAX        | UNITS                  |
|------------------|--|---|-------|---------|------------|------------------------|
| <b>Reference</b> |  |   |       |         |            |                        |
|                  | Reference Output Voltage               |   | 2.044 | 2.048   | 2.052      | V                      |
|                  | Reference Temperature Coefficient      | (Note 7)  |       | $\pm 2$ | $\pm 10$   | ppm/ $^\circ\text{C}$  |
|                  | Reference Line Regulation              | $V_{CC} \pm 10\%$   |       | -80     |            | dB                     |
|                  | Reference Short-Circuit Current        | $V_{CC} = 5.5\text{V}$ , Forcing Output to GND                        | ●     | 3       | 5          | mA                     |
|                  | Refcomp Pin Short-Circuit Current      | $V_{CC} = 5.5\text{V}$ , Forcing Output to GND                        | ●     | 60      | 200        | $\mu\text{A}$          |
|                  | Reference Load Regulation              | $V_{CC} = 5\text{V} \pm 10\%$ , $I_{OUT} = 100\mu\text{A}$ Sourcing   |       | 40      |            | mV/mA                  |
|                  | Reference Output Voltage Noise Density | $C_{REFCOMP} = C_{REFIN/OUT} = 0.1\mu\text{F}$ , at $f = 1\text{kHz}$ |       | 35      |            | nV/ $\sqrt{\text{Hz}}$ |
|                  | Reference Input Range                  | External Reference Mode (Note 13)                                     | ●     | 0.5     | $V_{CC}/2$ | V                      |
|                  | Reference Input Current                |   | ●     | 0.001   | 1          | $\mu\text{A}$          |
|                  | Reference Input Capacitance            | (Note 9)  | ●     | 20      |            | pF                     |

### Power Supply

|          |                                 |   |        |            |          |               |
|----------|---------------------------------|---|--------|------------|----------|---------------|
| $V_{CC}$ | Positive Supply Voltage         | For Specified Performance   | ●      | 4.5        | 5.5      | V             |
| $I_{CC}$ | Supply Current                  | $V_{CC} = 5\text{V}$ , Internal Reference On (Note 8) ●<br>$V_{CC} = 5\text{V}$ , Internal Reference Off (Note 8) ● | ●<br>● | 1.9<br>1.5 | 2.5<br>2 | mA<br>mA      |
| $I_{SD}$ | Supply Current in Shutdown Mode | $V_{CC} = 5\text{V}$ (Note 8)   | ●      |            | 3        | $\mu\text{A}$ |

### Digital I/O

|          |                             |   |   |                |         |               |
|----------|-----------------------------|---|---|----------------|---------|---------------|
| $V_{IH}$ | Digital Input High Voltage  | $V_{CC} = 4.5\text{V}$ to $5.6\text{V}$ | ● | 2.4            |         | V             |
| $V_{IL}$ | Digital Input Low Voltage   | $V_{CC} = 4.5\text{V}$ to $5.5\text{V}$ | ● |                | 0.8     | V             |
| $V_{OH}$ | Digital Output High Voltage | Load Current = $-100\mu\text{A}$        | ● | $V_{CC} - 0.4$ |         | V             |
| $V_{OL}$ | Digital Output Low Voltage  | Load Current = $100\mu\text{A}$         | ● |                | 0.4     | V             |
| $I_{LK}$ | Digital Input Leakage       | $V_{IN} = \text{GND}$ to $V_{CC}$       | ● |                | $\pm 1$ | $\mu\text{A}$ |
| $C_{IN}$ | Digital Input Capacitance   | (Note 9)                                | ● |                | 8       | pF            |

### AC Performance

|       |                             |   |  |            |  |                                |
|-------|-----------------------------|---|--|------------|--|--------------------------------|
| $t_S$ | Settling Time               | $\pm 0.024\%$ ( $\pm 1\text{LSB}$ at 12 Bits) (Note 10)<br>$\pm 0.0015\%$ ( $\pm 1\text{LSB}$ at 16 Bits) (Note 10) |  | 4.6<br>7.9 |  | $\mu\text{s}$<br>$\mu\text{s}$ |
|       | Settling Time for 1LSB Step | $\pm 0.024\%$ ( $\pm 1\text{LSB}$ at 12 Bits)<br>$\pm 0.0015\%$ ( $\pm 1\text{LSB}$ at 16 Bits)                     |  | 2.0<br>3.8 |  | $\mu\text{s}$<br>$\mu\text{s}$ |
|       | Voltage Output Slew Rate    |   |  | 1.8        |  | V/ $\mu\text{s}$               |
|       | Capacitive Load Driving     |   |  | 1000       |  | pF                             |
|       | Glitch Impulse              | At Mid-Scale Transition (Note 11)   |  | 6          |  | nV $\cdot$ s                   |
|       | DAC-to-DAC Crosstalk        | Due to Full-Scale Output Change (Note 12)   |  | 3          |  | nV $\cdot$ s                   |
|       | Multiplying Bandwidth       |   |  | 150        |  | kHz                            |

## ELECTRICAL CHARACTERISTICS

The ● denotes the specifications which apply over the full operating temperature range, otherwise specifications are at  $T_A = 25^\circ\text{C}$ .  $V_{CC} = 4.5\text{V}$  to  $5.5\text{V}$ ,  $V_{OUT}$  unloaded unless otherwise specified.

LTC2654B-H16/ LTC2654-H12 (Internal Reference = 2.048V)

| SYMBOL | PARAMETER                    | CONDITIONS                          | MIN | TYP | MAX | UNITS                        |
|--------|------------------------------|-------------------------------------|-----|-----|-----|------------------------------|
| $e_n$  | Output Voltage Noise Density | At $f = 1\text{kHz}$                |     | 85  |     | $\text{nV}/\sqrt{\text{Hz}}$ |
|        |                              | At $f = 10\text{kHz}$               |     | 80  |     | $\text{nV}/\sqrt{\text{Hz}}$ |
|        | Output Voltage Noise         | 0.1Hz to 10Hz, Internal Reference   |     | 12  |     | $\mu\text{V}_{\text{P-P}}$   |
|        |                              | 0.1Hz to 200kHz, Internal Reference |     | 450 |     | $\mu\text{V}_{\text{P-P}}$   |

## TIMING CHARACTERISTICS

The ● denotes the specifications which apply over the full operating temperature range, otherwise specifications are at  $T_A = 25^\circ\text{C}$ .

LTC2654B-L16/LTC2654-L12/LTC2654B-H16/LTC2654-H12

| SYMBOL                                  | PARAMETER  | CONDITIONS  | MIN | TYP | MAX | UNITS |
|---|--|---|-----|-----|-----|-------|
| $V_{CC} = 2.7\text{V}$ to $5.5\text{V}$ |  |   |     |     |     |       |
| $t_1$                                   | SDI Valid to SCK Setup   |   | ●   | 4   |     | ns    |
| $t_2$                                   | SDI Valid to SCK Hold  |   | ●   | 4   |     | ns    |
| $t_3$                                   | SCK High Time  |   | ●   | 9   |     | ns    |
| $t_4$                                   | SCK Low Time   |   | ●   | 9   |     | ns    |
| $t_5$                                   | $\overline{\text{CS}}/\text{LD}$ Pulse Width   |   | ●   | 10  |     | ns    |
| $t_6$                                   | LSB SCK High to $\overline{\text{CS}}/\text{LD}$ High                                    |   | ●   | 7   |     | ns    |
| $t_7$                                   | $\overline{\text{CS}}/\text{LD}$ Low to SCK High   |   | ●   | 7   |     | ns    |
| $t_8$                                   | SDO Propagation Delay from SCK Falling Edge  | $C_{\text{LOAD}} = 10\text{pF}$<br>$V_{CC} = 4.5\text{V}$ to $5.5\text{V}$<br>$V_{CC} = 2.7\text{V}$ to $4.5\text{V}$ | ●   |     | 20  | ns    |
|   |  |   | ●   |     | 45  | ns    |
| $t_9$                                   | CLR Pulse Width  |   | ●   | 20  |     | ns    |
| $t_{10}$                                | $\overline{\text{CS}}/\text{LD}$ High to SCK Positive Edge                               |   | ●   | 7   |     | ns    |
| $t_{12}$                                | $\overline{\text{LDAC}}$ Pulse Width   |   | ●   | 15  |     | ns    |
| $t_{13}$                                | $\overline{\text{CS}}/\text{LD}$ High to $\overline{\text{LDAC}}$ High or Low Transition |   | ●   | 200 |     | ns    |
|   | SCK Frequency  | 50% Duty Cycle  | ●   |     | 50  | MHz   |

**Note 1:** Stresses beyond those listed under Absolute Maximum Ratings may cause permanent damage to the device. Exposure to any Absolute Maximum Rating condition for extended periods may affect device reliability and lifetime.

**Note 2:** All voltages with respect to GND.

**Note 3:** Linearity and monotonicity are defined from code  $k_L$  to code  $2^N - 1$ , where  $N$  is the resolution and  $k_L$  is the lower end code for which no output limiting occurs. For  $V_{\text{REF}} = 2.5\text{V}$  and  $N = 16$ ,  $k_L = 128$  and linearity is defined from code 128 to code 65535. For  $V_{\text{REF}} = 2.5\text{V}$  and  $N = 12$ ,  $k_L = 8$  and linearity is defined from code 8 to code 4,095.

**Note 4:** Inferred from measurement at code 128 (LTC2654-16), or code 8 (LTC2654-12).

**Note 5:** DC Crosstalk is measured with  $V_{CC} = 5\text{V}$  and using internal reference, with the measured DAC at mid-scale.

**Note 6:** This IC includes current limiting that is intended to protect the device during momentary overload conditions. Junction temperature can exceed the rated maximum during current limiting. Continuous operation above the specified maximum operating junction temperature may impair device reliability.

**Note 7:** Temperature coefficient is calculated by dividing the maximum change in output voltage by the specified temperature range. Maximum temperature coefficient is guaranteed for C-grade only.

**Note 8:** Digital inputs at 0V or  $V_{CC}$ .

**Note 9:** Guaranteed by design and not production tested.

**Note 10:** Internal Reference mode. DAC is stepped  $\frac{1}{4}$  scale to  $\frac{3}{4}$  scale and  $\frac{3}{4}$  scale to  $\frac{1}{4}$  scale. Load is  $2\text{k}\Omega$  in parallel with  $200\text{pF}$  to GND.

**Note 11:**  $V_{CC} = 5\text{V}$ , Internal Reference mode. DAC is stepped  $\pm 1$  LSB between half-scale and half-scale - 1. Load is  $2\text{k}\Omega$  in parallel with  $200\text{pF}$  to GND.

**Note 12:** DAC to DAC Crosstalk is the glitch that appears at the output of one DAC due to a full-scale change at the output of another DAC. It is measured with  $V_{CC} = 5\text{V}$  and using internal reference, with the measured DAC at mid-scale.  $C_{\text{REFIN/OUT}} = \text{No Load}$ .

**Note 13:** Gain error specification may be degraded for reference input voltages less than 1V. See Gain Error vs Reference Input Voltage curve in the Typical Performance Characteristics section.



# TYPICAL PERFORMANCE CHARACTERISTICS

LTC2654-L16

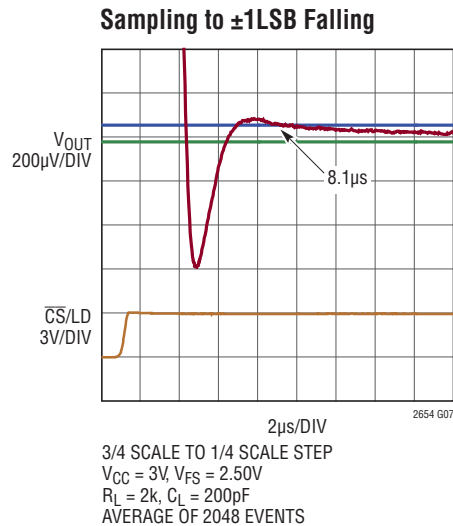
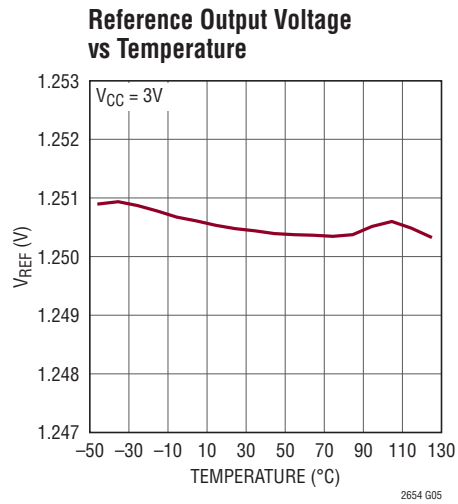
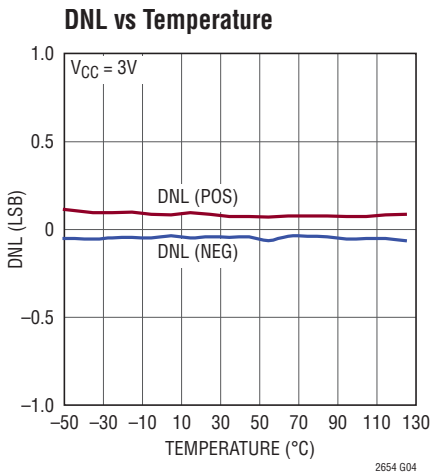

## TYPICAL PERFORMANCE CHARACTERISTICS

LTC2654-H16

**Integral Nonlinearity (INL)**

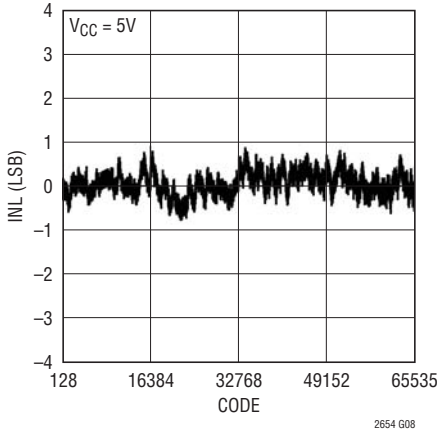

2654 G08

**Differential Nonlinearity (DNL)**

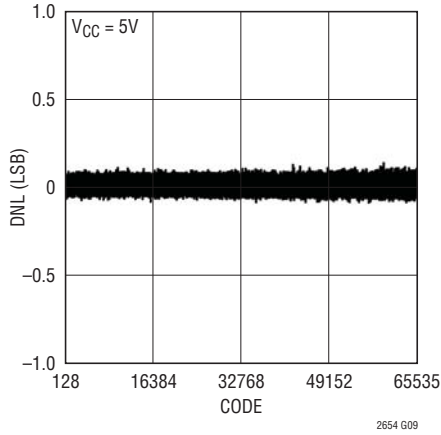

2654 G09

**INL vs Temperature**

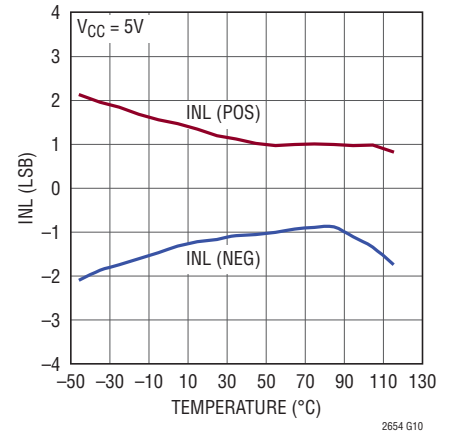

2654 G10

**DNL vs Temperature**

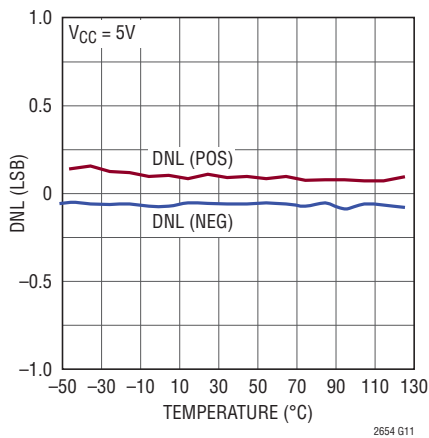

2654 G11

**Reference Output Voltage vs Temperature**

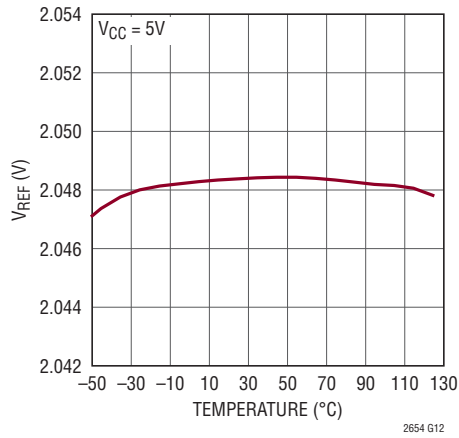

2654 G12

**Settling to  $\pm 1LSB$  Rising**

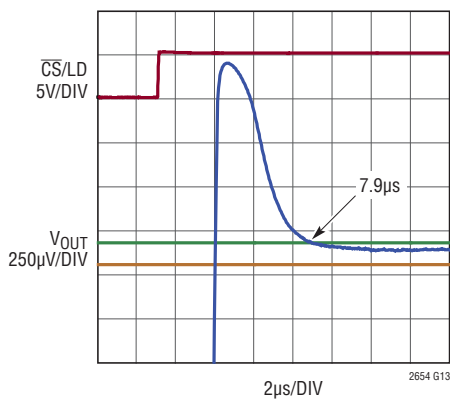

2654 G13

1/4 SCALE TO 3/4 SCALE STEP  
 $V_{CC} = 5V$ ,  $V_{FS} = 4.096V$   
 $R_L = 2k$ ,  $C_L = 200pF$   
 AVERAGE OF 2048 EVENTS

**Settling to  $\pm 1LSB$  Falling**

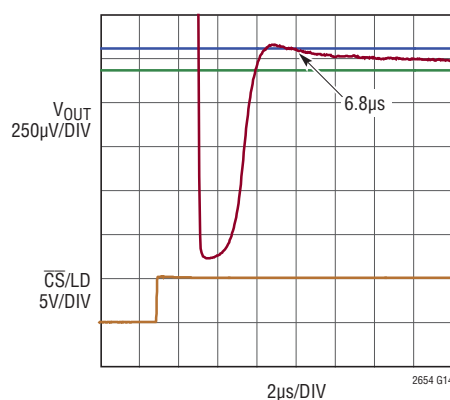

2654 G14

3/4 SCALE TO 1/4 SCALE STEP  
 $V_{CC} = 5V$ ,  $V_{FS} = 4.096V$   
 $R_L = 2k$ ,  $C_L = 200pF$   
 AVERAGE OF 2048 EVENTS

2654f

# TYPICAL PERFORMANCE CHARACTERISTICS

LTC2654-12

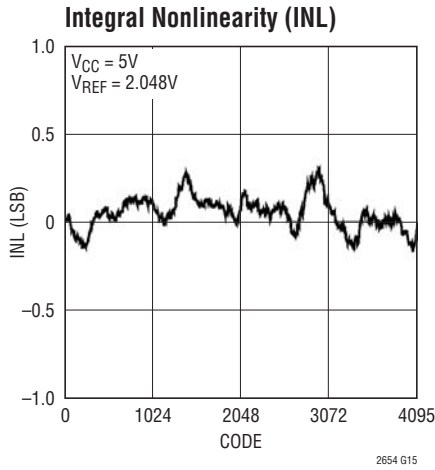

1/4 SCALE TO 3/4 SCALE STEP  
 $V_{CC} = 5V, V_{FS} = 4.095V, R_L = 2k, C_L = 200pF$   
AVERAGE OF 2048 EVENTS

## LTC2654-16

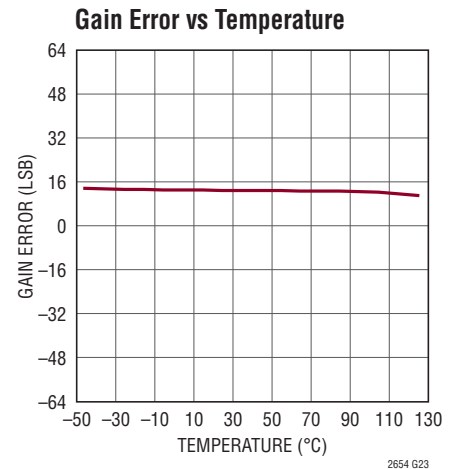
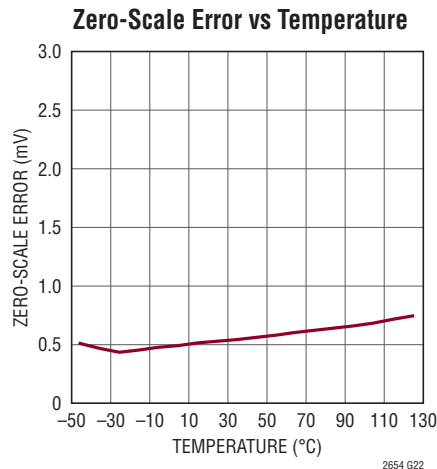
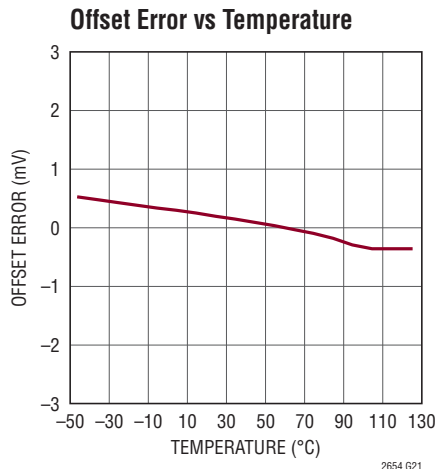
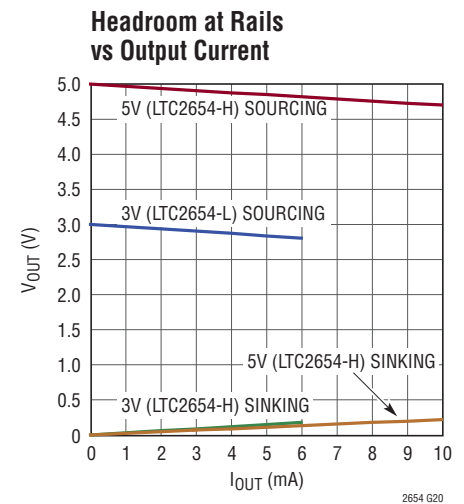
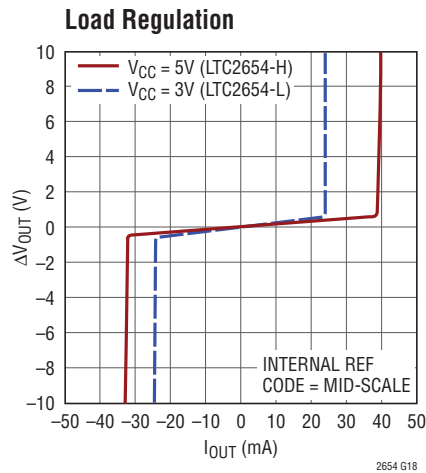

## TYPICAL PERFORMANCE CHARACTERISTICS

LTC2654-16

**Offset Error vs Reference Input**



**Gain Error vs Reference Input**

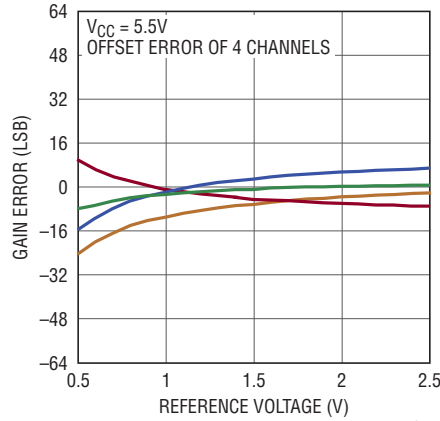

**$I_{CC}$  Shutdown vs  $V_{CC}$**



**Supply Current vs Logic Voltage**

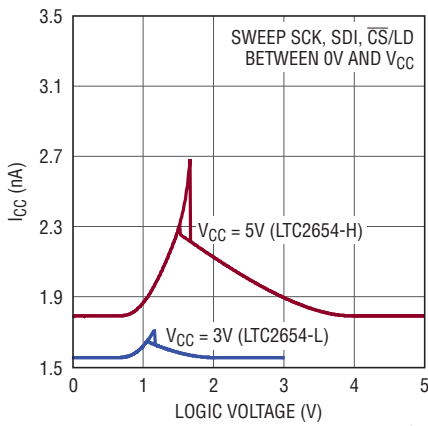

**Hardware  $\overline{CLR}$  to Mid-Scale**

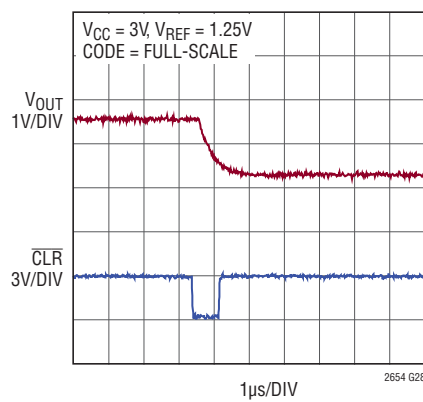

**Hardware  $\overline{CLR}$**

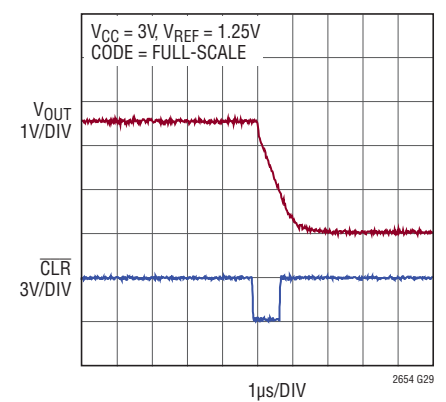

**Multiplying Bandwidth**



**Large-Signal Response**



**Mid-Scale Glitch Impulse**

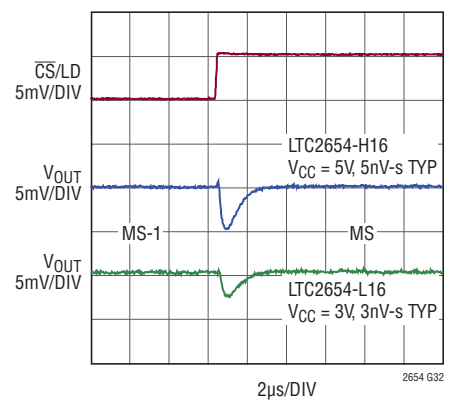

# TYPICAL PERFORMANCE CHARACTERISTICS

LTC2654-16

**DAC to DAC Crosstalk (Dynamic)**

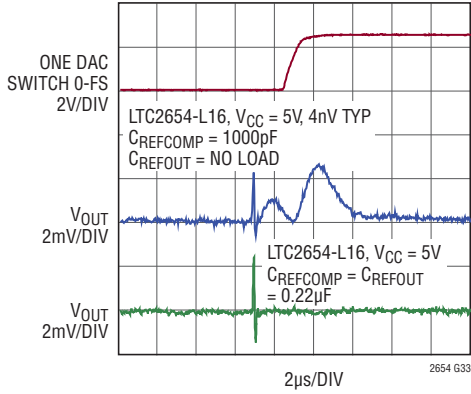

**Power-On Reset Glitch**

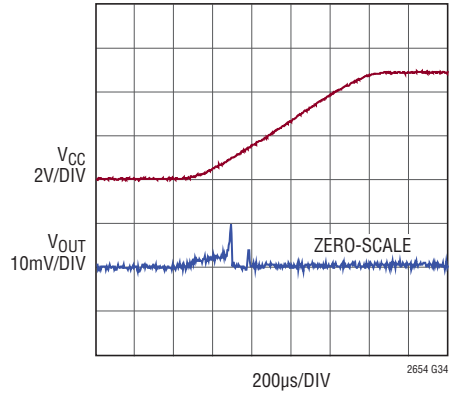

**Power-On Reset to Mid-Scale**

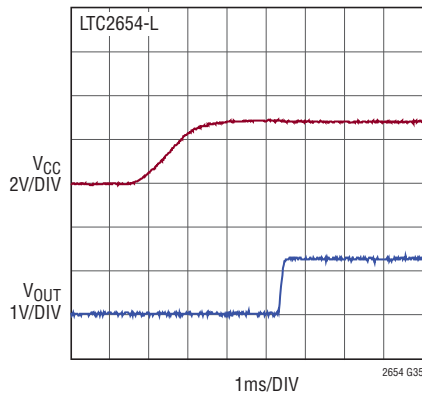

**Noise Voltage vs Frequency**

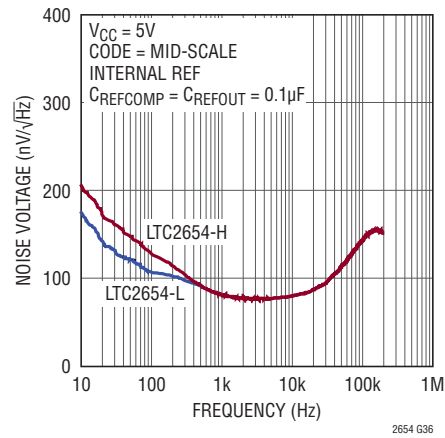

**DAC Output 0.1Hz to 10Hz Voltage Noise**

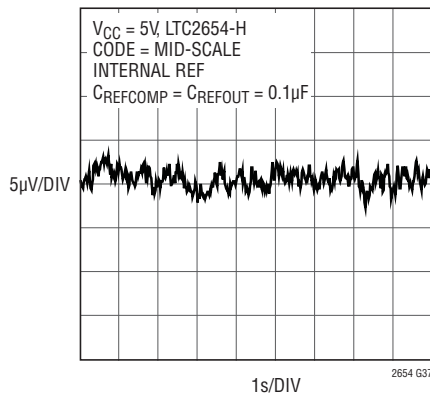

**Reference 0.1Hz to 10Hz Voltage Noise**

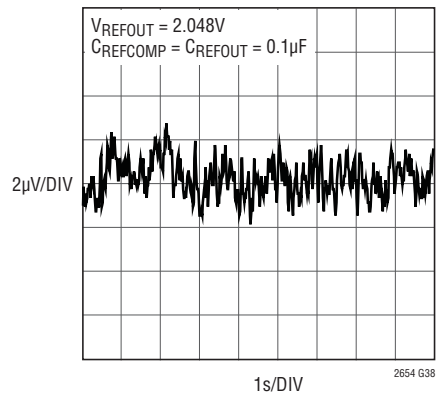

## PIN FUNCTIONS (QFN/SSOP)

**V<sub>OUTA</sub> to V<sub>OUTD</sub> (Pins 1, 3, 13, 14/Pins 2, 4, 13, 14):** DAC Analog Voltage Outputs. The output range is 0V to 2 times the voltage at the REFIN/OUT pin.

**REFCOMP (Pin 2/Pin 3):** Internal Reference Compensation pin. For low noise and reference stability, tie a 0.1 $\mu$ F capacitor to GND. Connecting this pin to GND allows the use of external reference at start-up.

**REFIN/OUT (Pin 4/Pin 5):** Reference Input/Output. This pin acts as the internal reference output in internal reference mode and acts as the reference input pin in external reference mode. When acting as an output the nominal voltage at this pin is 1.25V for -L options and 2.048V for -H options. For low noise and reference stability tie a capacitor to GND. Capacitor value must be  $\leq C_{\text{REFCOMP}}$ . In external reference mode, the allowable reference input voltage range is 0.5V to  $V_{\text{CC}}/2$ .

**LDAC (Pin 5/Pin 6):** Asynchronous DAC Update Pin. If  $\overline{\text{CS/LD}}$  is high, a falling edge on  $\overline{\text{LDAC}}$  immediately updates the DAC register with the contents of the input register (similar to a software update). If  $\overline{\text{CS/LD}}$  is low when  $\overline{\text{LDAC}}$  goes low, the DAC register is updated after  $\overline{\text{CS/LD}}$  returns high. A low on the  $\overline{\text{LDAC}}$  pin powers up the DAC outputs. All the software power-down commands are ignored if  $\overline{\text{LDAC}}$  is low when  $\overline{\text{CS/LD}}$  goes high.

**CS/LD (Pin 6/Pin 7):** Serial Interface Chip Select/Load Input. When  $\overline{\text{CS/LD}}$  is low, SCK is enabled for shifting data on SDI into the register. When  $\overline{\text{CS/LD}}$  is taken high, SCK is disabled and the specified command (see Table 1) is executed.

**SCK (Pin 7/Pin 8):** Serial Interface Clock Input. CMOS and TTL compatible.

**DNC (Pins 8, 15, 16, 17/NA):** Do not connect these pins.

**SDI (Pin 9/Pin 9):** Serial Interface Data Input. Data is applied to SDI for transfer to the device at the rising edge of SCK (Pin 10). The LTC2654 accepts input word lengths of either 24 or 32 bits. See Figures 2a and 2b.

**SDO (Pin 10/Pin 10):** Serial Interface Data Output. This pin is used for daisy-chain operation. The serial output of the shift register appears at the SDO pin. The data transferred to the device via the SDI pin is delayed 32 SCK rising edges before being output at the next falling edge. This pin is continuously driven and does not go high impedance when  $\overline{\text{CS/LD}}$  is taken active high.

**CLR (Pin 11/Pin 11):** Asynchronous Clear Input. A logic low at this level-triggered input clears all registers and causes the DAC voltage outputs to drop to 0V if PORSEL pin is tied to GND. If the PORSEL pin is tied to  $V_{\text{CC}}$ , a logic low at  $\overline{\text{CLR}}$  sets all registers to mid-scale code and causes the DAC voltage outputs to go to mid-scale.

**PORSEL (Pin 12/Pin 12):** Power-On-Reset Select Pin. If tied to GND, the DACs reset to zero-scale. If tied to  $V_{\text{CC}}$ , the DACs reset to mid-scale.

**V<sub>CC</sub> (Pin 18/Pin 15):** Supply Voltage Input. For -L options,  $2.7\text{V} \leq V_{\text{CC}} \leq 5.5\text{V}$ , and for -H options,  $4.5\text{V} \leq V_{\text{CC}} \leq 5.5\text{V}$ . Should be bypassed by a 0.1 $\mu$ F low ESR ceramic capacitor to GND.

**GND (Pin 19, Exposed Pad Pin 21/Pin 16):** Ground. Exposed pad must be soldered to PCB Ground.

**REFLO (Pin 20/Pin 1):** Reference Low Pin. The voltage at this pin sets the zero-scale voltage of all DACs. This pin should be tied to GND.

# BLOCK DIAGRAM

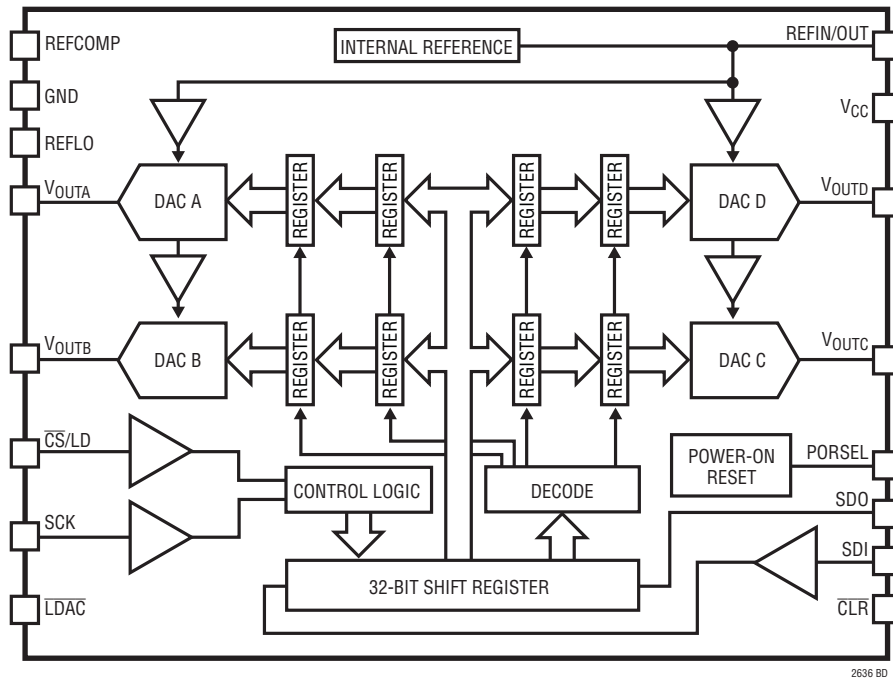

2636 BD

# TIMING DIAGRAMS

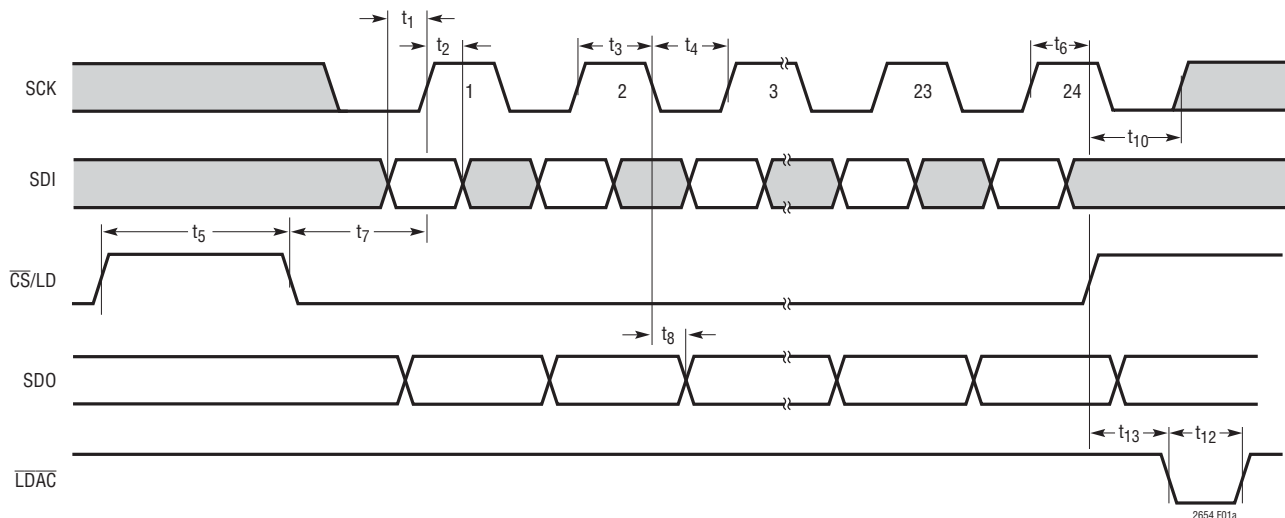

2654 F01a

Figure 1a

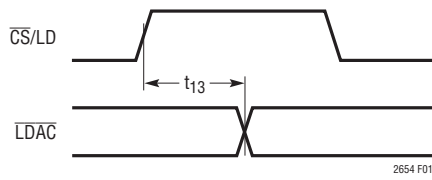

2654 F01b

Figure 1b

## OPERATION

The LTC2654 is a family of quad voltage output DACs in 20-lead 4mm × 4mm QFN and in 16-lead narrow SSOP packages. Each DAC can operate rail-to-rail in external reference mode, or with its full-scale voltage set by an integrated reference. Four combinations of accuracy (16-bit and 12-bit), and full-scale voltage (2.5V or 4.096V) are available. The LTC2654 is controlled using a 4-wire SPI/MICROWIRE compatible interface.

### Power-On Reset

The LTC2654-L/LTC2654-H clear the output to zero-scale if PORSEL pin is tied to GND, when power is first applied, making system initialization consistent and repeatable. For some applications, downstream circuits are active during DAC power-up, and may be sensitive to nonzero outputs from the DAC during this time. The LTC2654 contains circuitry to reduce the power-on glitch. The analog outputs typically rise less than 10mV above zero-scale during power-on if the power supply is ramped to 5V in 1ms or more. In general, the glitch amplitude decreases as the power supply ramp time is increased. See Power-On-Reset Glitch in the Typical Performance Characteristics section.

Alternatively, if PORSEL pin is tied to  $V_{CC}$  (Pin 18/Pin 15), The LTC2654-L/LTC2654-H set the output to mid-scale when power is first applied.

### Power Supply Sequencing and Start-Up

For LTC2654 family of parts, the internal reference is powered-up at start-up by default. If an external reference is to be used, the REFCOMP pin (Pin 2/Pin 3) must be hardwired to GND. Having REFCOMP hardwired to GND at power up, will cause the REFIN/OUT pin to become high-impedance and will allow for the use of an external reference at start-up. However in this configuration, internal reference will still be ON, even though it is disconnected from the REFIN/OUT pin and it will draw supply current. In order to use external reference after power-up, the command Select External Reference (0111b) should be used to turn the internal reference off (See Table 1).

The voltage at REFIN/OUT (Pin 4/Pin 5) should be kept within the range  $-0.3V \leq \text{REFIN/OUT} \leq V_{CC} + 0.3V$  (see Absolute Maximum Ratings). Particular care should be taken to observe these limits during power supply turn-on and turn-off sequences, when the voltage at  $V_{CC}$  (Pin 18/Pin 15) is in transition.

### Transfer Function

The digital-to-analog transfer function is

$$V_{\text{OUT(IDEAL)}} = \left( \frac{k}{2^N} \right) \cdot 2 \cdot [V_{\text{REF}} - V_{\text{REFLO}}] + V_{\text{REFLO}}$$

where  $k$  is the decimal equivalent of the binary DAC input code,  $N$  is the resolution of the DAC, and  $V_{\text{REF}}$  is the voltage at the REFIN/OUT Pin. The resulting DAC output span is 0V to  $2 \cdot V_{\text{REF}}$ , as it is necessary to tie REFLO to GND.  $V_{\text{REF}}$  is nominally 1.25V for LTC2654-L and 2.048V for LTC2654-H, in Internal Reference Mode.

**Table 1. Command and Address Codes**

| COMMAND*         |    |    |    |   |
|------------------|----|----|----|---|
| C3               | C2 | C1 | C0 |   |
| 0                | 0  | 0  | 0  | Write to Input Register $n$                         |
| 0                | 0  | 0  | 1  | Update (Power-Up) DAC Register $n$                  |
| 0                | 0  | 1  | 0  | Write to Input Register $n$ , Update (Power-Up) All |
| 0                | 0  | 1  | 1  | Write to and Update (Power-Up) $n$                  |
| 0                | 1  | 0  | 0  | Power-Down $n$                                      |
| 0                | 1  | 0  | 1  | Power-Down Chip (All DAC's and Reference)           |
| 0                | 1  | 1  | 0  | Select Internal Reference (Power-Up Reference)      |
| 0                | 1  | 1  | 1  | Select External Reference (Power-Down Reference)    |
| 1                | 1  | 1  | 1  | No Operation  |
| ADDRESS ( $n$ )* |    |    |    |   |
| A3               | A2 | A1 | A0 |   |
| 0                | 0  | 0  | 0  | DAC A   |
| 0                | 0  | 0  | 1  | DAC B   |
| 0                | 0  | 1  | 0  | DAC C   |
| 0                | 0  | 1  | 1  | DAC D   |
| 1                | 1  | 1  | 1  | All DACs  |

\*Command and address codes not shown are reserved and should not be used.



## OPERATION

### Serial Interface

The  $\overline{\text{CS/LD}}$  input is level triggered. When this input is taken low, it acts as a chip-select signal, powering on the SDI and SCK buffers and enabling the input shift register. Data (SDI input) is transferred at the next 24 rising SCK edges. The 4-bit command, C3-C0, is loaded first; followed by the 4-bit DAC address, A3-A0; and finally the 16-bit data word. For the LTC2654-16 the data word comprises the 16-bit input code, ordered MSB-to-LSB. For the LTC2654-12 the data word comprises the 12-bit input code, ordered MSB-to-LSB followed by four don't-care bits. Data can only be transferred to the LTC2654 when the  $\overline{\text{CS/LD}}$  signal is low. The rising edge of  $\overline{\text{CS/LD}}$  ends the data transfer and causes the device to carry out the action specified in the 24-bit input word. The complete sequence is shown in Figure 2a.

The command (C3-C0) and address (A3-A0) assignments are shown in Table 1. The first four commands in the table consist of write and update operations. A write operation loads a 16-bit data word from the 32-bit shift register into the input register of the selected DAC,  $n$ . An update operation copies the data word from the input register to the DAC register. Once copied into the DAC register, the data word becomes the active 16- or 12-bit input code, and is converted to an analog voltage at the DAC output. The update operation also powers up the selected DAC if it had been in power-down mode. The data path and registers are shown in the block diagram.

While the minimum input word is 24 bits, it may optionally be extended to 32 bits. To use the 32-bit word width, 8 don't-care bits are transferred to the device first, followed by the 24-bit word as just described. Figure 2b shows the 32-bit sequence. The 32-bit word is required for daisy chain operation, and is also available to accommodate microprocessors that have a minimum word width of 16 bits (2 bytes). The 16-bit data word is ignored for all commands that do not include a write operation.

### Daisy-Chain Operation

The serial output of the shift register appears at the SDO pin. Data transferred to the device from the SDI input is delayed 32 SCK rising edges before being output at the next SCK falling edge. The SDO pin is continuously driven and does not go high impedance when  $\overline{\text{CS/LD}}$  is taken active high.

The SDO output can be used to facilitate control of multiple serial devices from a single 3-wire serial port (i.e., SCK, SDI and  $\overline{\text{CS/LD}}$ ). Such a daisy-chain series is configured by connecting SDO of each up-stream device to SDI of the next device in the chain. The shift registers of the devices are thus connected in series, effectively forming a single input shift register which extends through the entire chain. Because of this, the devices can be addressed and controlled individually by simply concatenating their input words; the first instruction addresses the last device in the chain and so forth. The SCK and  $\overline{\text{CS/LD}}$  signals are common to all devices in the series.

In use,  $\overline{\text{CS/LD}}$  is first taken low. Then the concatenated input data is transferred to the chain, using SDI of the first device as the data input. When the data transfer is complete,  $\overline{\text{CS/LD}}$  is taken high, completing the instruction sequence for all devices simultaneously. A single device can be controlled by using the no-operation command (1111b) for the other devices in the chain.

### Power-Down Mode

For power-constrained applications, power-down mode can be used to reduce the supply current whenever less than four DAC outputs are needed. When in power-down, the buffer amplifiers, bias circuits and integrated reference circuits are disabled, and draw essentially zero current. The DAC outputs are put into a high-impedance state, and the output pins are passively pulled to ground through individual 80k resistors. Input- and DAC-register contents are not disturbed during power-down.

OPERATION

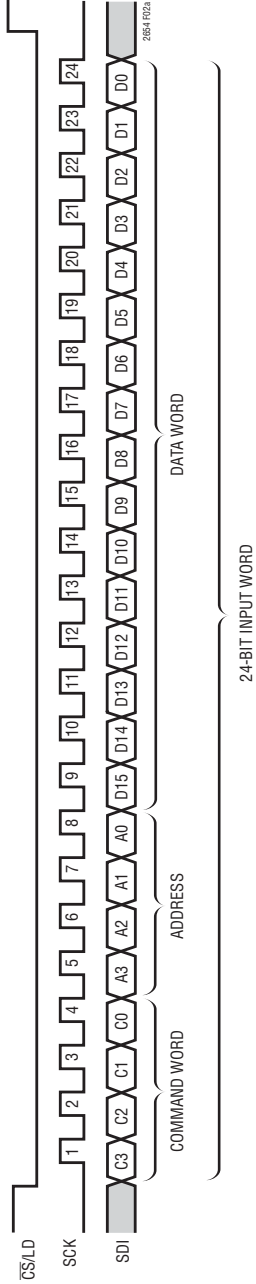

Figure 2a. LTC2654-16 24-Bit Load Sequence (Minimum Input Word)  
LTC2654-12 SDI Data Word: 12-Bit Input Code + 4 Don't Care Bits

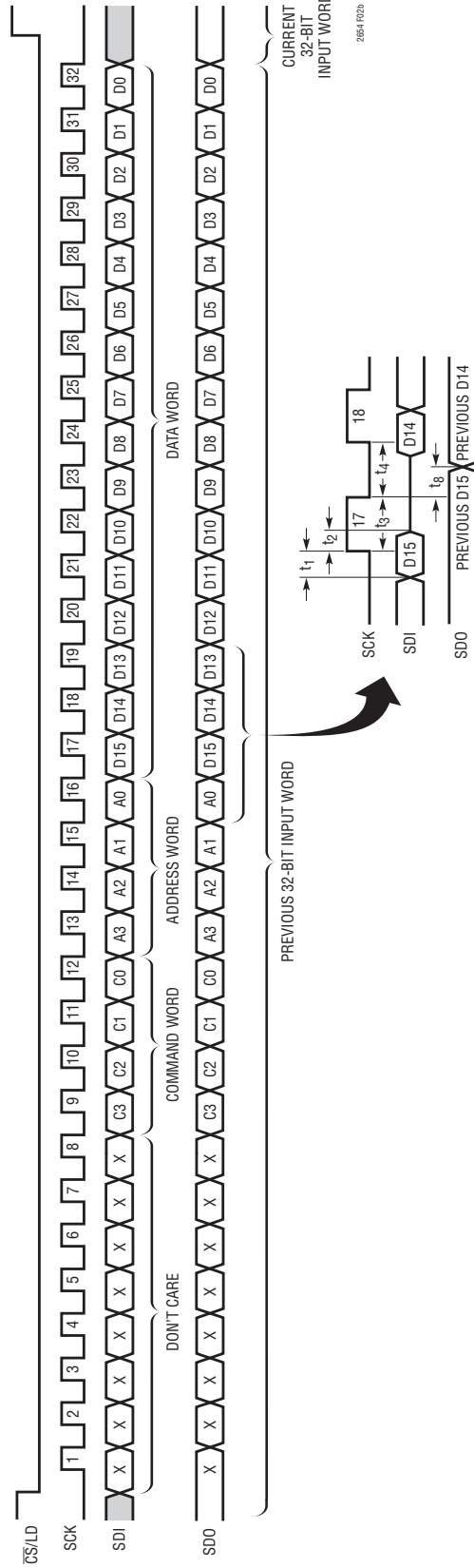

Figure 2b. LTC2654-16 32-Bit Load Sequence.  
LTC2654-12 SDI/SDO Data Word: 12-Bit Input Code + 4 Don't Care Bits

## OPERATION

Any channel or combination of DAC channels can be put into power-down mode by using command 0100b in combination with the appropriate DAC address, (*n*). The integrated reference is automatically powered down when external reference is selected using command 0111b. In addition, all the DAC channels and the integrated reference together can be put into power-down mode using Power-Down Chip command 0101b. For all power-down commands the 16-bit data word is ignored, but still needs to be clocked in.

Normal operation resumes by executing any command which includes a DAC update, in software as shown in Table 1 or by taking the asynchronous  $\overline{\text{LDAC}}$  pin low. The selected DAC is powered up as its voltage output is updated. When a DAC which is in a powered-down state is powered up and updated, normal settling is delayed. If less than four DACs are in a powered-down state prior to the update command, the power-up delay time is 12 $\mu$ s. If on the other hand, all four DACs and the integrated reference are powered down, then the main bias generation circuit block has been automatically shut down in addition to the individual DAC amplifiers and integrated reference. In this case, the power up delay time is 14 $\mu$ s. The power-up of integrated reference depends on the command that powered it down. If the reference is powered down using the Select External Reference Command (0111b) then it can only be powered back-up using Select Internal Reference Command (0110b). However if the reference was powered down using Power-Down Chip Command (0101b) then in addition to Select Internal Reference Command (0110b), any command that powers up the DACs will also power-up the integrated reference.

### Asynchronous DAC Update Using $\overline{\text{LDAC}}$

In addition to the update commands shown in Table 1, the  $\overline{\text{LDAC}}$  pin asynchronously updates all the DAC registers with the contents of the input registers.

If  $\overline{\text{CS/LD}}$  is high, a low on the  $\overline{\text{LDAC}}$  pin causes all the DAC registers to be updated with the contents of the input registers.

If  $\overline{\text{CS/LD}}$  is low, a low going pulse on the  $\overline{\text{LDAC}}$  pin before the rising edge of  $\overline{\text{CS/LD}}$  powers up all the DAC outputs but does not cause the output to be updated. If  $\overline{\text{LDAC}}$  remains

low after the rising edge of  $\overline{\text{CS/LD}}$ , then  $\overline{\text{LDAC}}$  is recognized, the command specified in the 24-bit word just transferred is executed and the DAC outputs are updated.

The DAC outputs are powered up when  $\overline{\text{LDAC}}$  is taken low, independent of the state of  $\overline{\text{CS/LD}}$ . The integrated reference is also powered up if it was powered down using Power-Down Chip (0101b) command. The integrated reference will not power up when  $\overline{\text{LDAC}}$  is taken low, if it was powered down using Select External Reference (0111b) Command.

If  $\overline{\text{LDAC}}$  is low at the time  $\overline{\text{CS/LD}}$  goes high, it inhibits any software power-down command (Power-Down *n*, Power-Down Chip, Select External Reference) that was specified in the input word.

### Reference Modes

For applications where an accurate external reference is not available, the LTC2654 has a user-selectable, integrated reference. The LTC2654-L has a 1.25V reference that provides a full-scale output of 2.5V. The LTC2654-H has a 2.048V reference that provides a full-scale output of 4.096V. Both references exhibit a typical temperature drift of 2ppm/ $^{\circ}$ C. Internal reference mode can be selected by using command 0110b, and is the power-on default. A buffer is needed if the internal reference is required to drive external circuitry. For reference stability and low noise, connect a 0.1 $\mu$ F capacitor between REFCOMP and GND. In this configuration, the internal reference can drive up to 0.1 $\mu$ F capacitive load without any stability problems. In order to ensure stable operation, the capacitive load on REFIN/OUT pin should not exceed the capacitive load on the REFCOMP pin.

The DAC can also operate in external reference mode using command 0111b. In this mode, REFIN/OUT pin acts as an input that sets the DAC's reference voltage. The input is high impedance and does not load the external reference source. The acceptable voltage range at this pin is  $0.5\text{V} \leq \text{REFIN/OUT} \leq V_{\text{CC}}/2$ . The resulting full-scale output voltage is  $2 \cdot V_{\text{REFIN/OUT}}$ . For using External Reference at start-up, see the Power Supply Sequencing and Start-Up Section.

## OPERATION

### Integrated Reference Buffers

Each of the four DACs in the LTC2654 has its own integrated high performance reference buffer. The buffers have very high input impedance and do not load the reference voltage source. These buffers shield the reference voltage from glitches caused by DAC switching and thus minimize DAC-to-DAC Dynamic Crosstalk. Typically DAC-to-DAC crosstalk is less than  $3\text{nV}\cdot\text{s}$ . By tying  $0.22\mu\text{F}$  capacitors between REFCOMP and GND, and also between REFIN/OUT and GND, this number can be reduced to less than  $1\text{nV}\cdot\text{s}$ . See the curve DAC-to-DAC Dynamic Crosstalk in the Typical Performance Characteristics section.

### Voltage Outputs

Each of the LTC2654's four rail-to-rail output amplifiers contained in these parts has guaranteed load regulation when sourcing or sinking up to  $15\text{mA}$  at  $5\text{V}$  ( $7.5\text{mA}$  at  $3\text{V}$ ).

Load regulation is a measure of the amplifier's ability to maintain the rated voltage accuracy over a wide range of load conditions. The measured change in output voltage per milliampere of forced load current change is expressed in  $\text{LSB}/\text{mA}$ .

DC output impedance is equivalent to load regulation, and may be derived from it by simply calculating a change in units from  $\text{LSB}/\text{mA}$  to Ohms. The amplifiers' DC output impedance is  $0.04\Omega$  when driving a load well away from the rails.

When drawing a load current from either rail, the output voltage headroom with respect to that rail is limited by the  $30\Omega$  typical channel resistance of the output devices; e.g., when sinking  $1\text{mA}$ , the minimum output voltage =  $30\Omega \cdot 1\text{mA} = 30\text{mV}$ . See the graph Headroom at Rails vs Output Current in the Typical Performance Characteristics section.

The amplifiers are stable driving capacitive loads of up to  $1000\text{pF}$ .

### Board Layout

The excellent load regulation and DC crosstalk performance of these devices is achieved in part by keeping signal and power grounds separate.

The PC board should have separate areas for the analog and digital sections of the circuit. This keeps digital signals away from sensitive analog signals and facilitates the use of separate digital and analog ground planes which have minimal capacitive and resistive interaction with each other.

Digital and analog ground planes should be joined at only one point, establishing a system star ground as close to the device's ground pin as possible. Ideally, the analog ground plane should be located on the component side of the board, and should be allowed to run under the part to shield it from noise. Analog ground should be a continuous and uninterrupted plane, except for necessary lead pads and vias, with signal traces on another layer.

The GND pin functions as a return path for power supply currents in the device and should be connected to analog ground. The REFLO pin should be connected to system star ground. Resistance from the REFLO pin to system star ground should be as low as possible.

### Rail-to-Rail Output Considerations

In any rail-to-rail voltage output device, the output is limited to voltages within the supply range.

Since the analog outputs of the device cannot go below ground, they may limit for the lowest codes as shown in Figure 3b. Similarly, limiting can occur in external reference mode near full-scale when the REFIN/OUT pin is at  $V_{\text{CC}}/2$ . If  $V_{\text{REFIN/OUT}} = V_{\text{CC}}/2$  and the DAC full-scale error (FSE) is positive, the output for the highest codes limits at  $V_{\text{CC}}$  as shown in Figure 3c. No full-scale limiting can occur if  $V_{\text{REFIN/OUT}} \leq (V_{\text{CC}} - \text{FSE})/2$ .

Offset and linearity are defined and tested over the region of the DAC transfer function where no output limiting can occur.

OPERATION

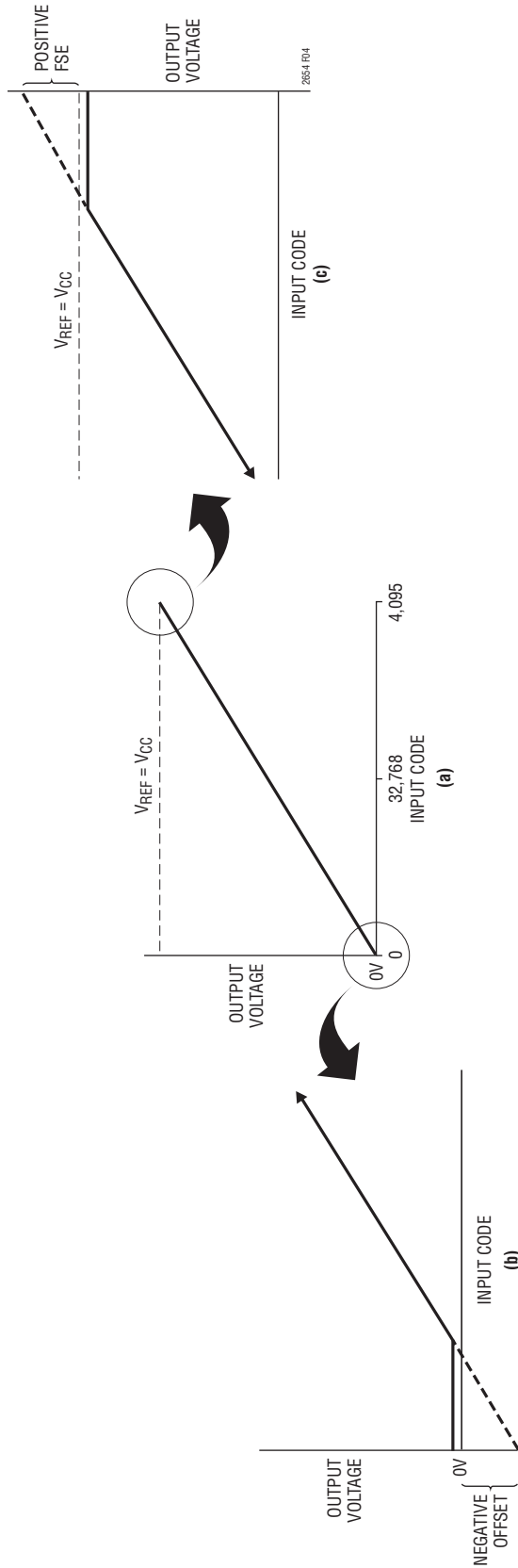
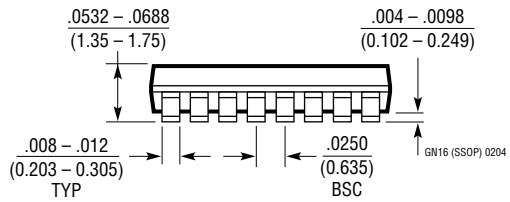
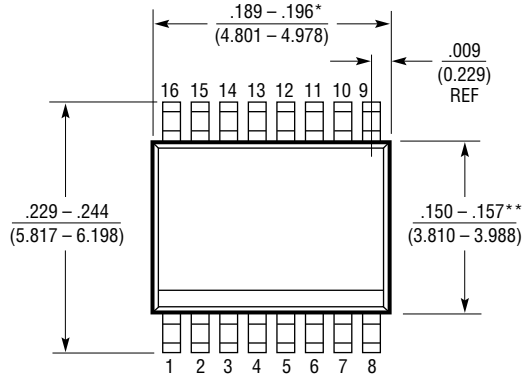

Figure 3. Effects of Rail-to-Rail Operation on a DAC Transfer Curve. (a) Overall Transfer Function (b) Effect of Negative Offset for Codes Near Zero Scale (c) Effect of Positive Full-Scale Error for Codes Near Full-Scale

**PACKAGE DESCRIPTION**

**GN Package**  
**16-Lead Plastic SSOP (Narrow .150 Inch)**  
 (Reference LTC DWG # 05-08-1641)



- NOTE:
1. CONTROLLING DIMENSION: INCHES
  2. DIMENSIONS ARE IN  $\frac{\text{INCHES}}{\text{MILLIMETERS}}$
  3. DRAWING NOT TO SCALE
- \*DIMENSION DOES NOT INCLUDE MOLD FLASH. MOLD FLASH SHALL NOT EXCEED 0.006" (0.152mm) PER SIDE
- \*\*DIMENSION DOES NOT INCLUDE INTERLEAD FLASH. INTERLEAD FLASH SHALL NOT EXCEED 0.010" (0.254mm) PER SIDE

# PACKAGE DESCRIPTION

## UF Package 20-Lead Plastic QFN (4mm × 4mm) (Reference LTC DWG # 05-08-1710)



RECOMMENDED SOLDER PAD PITCH AND DIMENSIONS  
APPLY SOLDER MASK TO AREAS THAT ARE NOT SOLDERED

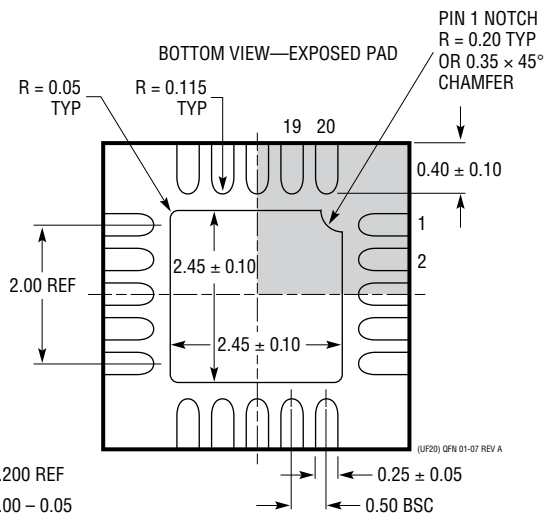
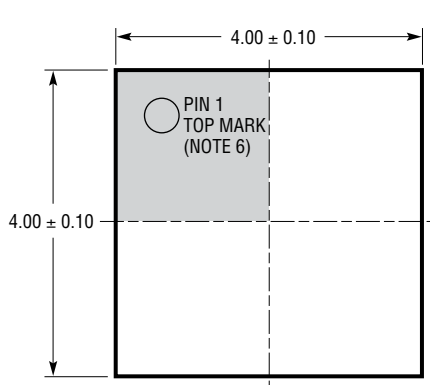

**NOTE:**

1. DRAWING IS PROPOSED TO BE MADE A JEDEC PACKAGE OUTLINE MO-220 VARIATION (WGGD-1)—TO BE APPROVED
2. DRAWING NOT TO SCALE
3. ALL DIMENSIONS ARE IN MILLIMETERS
4. DIMENSIONS OF EXPOSED PAD ON BOTTOM OF PACKAGE DO NOT INCLUDE MOLD FLASH. MOLD FLASH, IF PRESENT, SHALL NOT EXCEED 0.15mm ON ANY SIDE
5. EXPOSED PAD SHALL BE SOLDER PLATED
6. SHADED AREA IS ONLY A REFERENCE FOR PIN 1 LOCATION ON THE TOP AND BOTTOM OF PACKAGE



## TYPICAL APPLICATION

## True Rail-to-Rail Output DAC

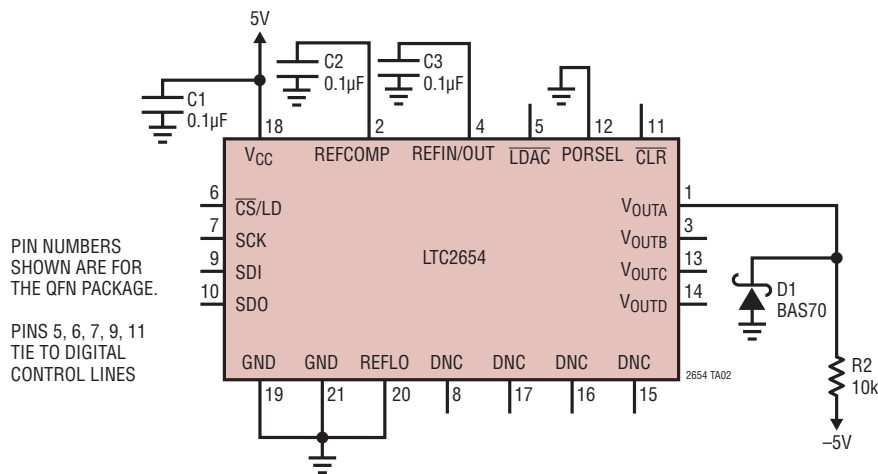

## RELATED PARTS

| PART NUMBER                 | DESCRIPTION  | COMMENTS  |
|-----------------------------|--|---|
| LTC1660/LTC1665             | Octal 10-/8-Bit $V_{OUT}$ DACs in 16-Pin Narrow SSOP                         | $V_{CC} = 2.7V$ to $5.5V$ , Micropower, Rail-to-Rail Output   |
| LTC1664                     | Quad 10-Bit $V_{OUT}$ DAC in 16-Pin Narrow SSOP                              | $V_{CC} = 2.7V$ to $5.5V$ , Micropower, Rail-to-Rail Output   |
| LTC1821                     | Single 16-Bit $V_{OUT}$ DAC with $\pm 1$ LSB INL, DNL                        | Parallel Interface, Precision 16-Bit Settling in $2\mu s$ for 10V Step  |
| LTC2656                     | Octal 16-/12-Bit $V_{OUT}$ DACs  | $325\mu A$ per DAC, $2.7V$ to $5.5V$ Supply Range, Rail-to-Rail Output, SPI Serial Interface, Internal Reference              |
| LTC2601/LTC2611/<br>LTC2621 | Single 16-/14-/12-Bit $V_{OUT}$ DACs in 10-Lead DFN                          | $300\mu A$ per DAC, $2.5V$ to $5.5V$ Supply Range, Rail-to-Rail Output, SPI Serial Interface                                  |
| LTC2602/LTC2612/<br>LTC2622 | Dual 16-/14-/12-Bit $V_{OUT}$ DACs in 8-Lead MSOP                            | $300\mu A$ per DAC, $2.5V$ to $5.5V$ Supply Range, Rail-to-Rail Output, SPI Serial Interface                                  |
| LTC2604/LTC2614/<br>LTC2624 | Quad 16-/14-/12-Bit $V_{OUT}$ DACs in 16-Lead SSOP                           | $250\mu A$ per DAC, $2.5V$ to $5.5V$ Supply Range, Rail-to-Rail Output, SPI Serial Interface                                  |
| LTC2605/LTC2615/<br>LTC2625 | Octal 16-/14-/12-Bit $V_{OUT}$ DACs with $I^2C$ Interface                    | $250\mu A$ per DAC, $2.7V$ to $5.5V$ Supply Range, Rail-to-Rail Output  |
| LTC2606/LTC2616/<br>LTC2626 | Single 16-/14-/12-Bit $V_{OUT}$ DACs with $I^2C$ Interface                   | $270\mu A$ per DAC, $2.7V$ to $5.5V$ Supply Range, Rail-to-Rail Output  |
| LTC2609/LTC2619/<br>LTC2629 | Quad 16-/14-/12-Bit $V_{OUT}$ DACs with $I^2C$ Interface                     | $250\mu A$ per DAC, $2.7V$ to $5.5V$ Supply Range, Rail-to-Rail Output with Separate $V_{REF}$ Pins for Each DAC              |
| LTC2634                     | Quad 12-/10-/8-Bit $V_{OUT}$ DACs with $10ppm/^{\circ}C$ (Typical) Reference | $125\mu A$ per DAC, $2.7V$ to $5.5V$ Supply Range, Internal $1.25V$ or $2.048V$ Reference, Rail-to-Rail Output, SPI Interface |
| LTC2636                     | Octal 12-/10-/8-Bit $V_{OUT}$ DACs with $10ppm/^{\circ}C$ Reference          | $125\mu A$ per DAC, $2.7V$ to $5.5V$ Supply Range, Internal $1.25V$ or $2.048V$ Reference, Rail-to-Rail Output, SPI Interface |
| LTC2641/LTC2642             | Single 16-/14-/12-Bit $V_{OUT}$ DACs with $\pm 1$ LSB INL, DNL               | $\pm 1$ LSB (Max) INL, DNL, $3mm \times 3mm$ DFN and MSOP Packages, $120\mu A$ Supply Current, SPI Interface                  |
| LTC2704                     | Quad 16-/14-/12-Bit $V_{OUT}$ DACs with $\pm 2$ LSB INL, $\pm 1$ LSB DNL     | Software Programmable Output Ranges Up to $\pm 10V$ , SPI Interface   |
| LTC2754                     | Quad 16-/14-/12-Bit SPI $I_{OUT}$ DACs with $\pm 1$ LSB INL, $\pm 1$ LSB DNL | Software Programmable Output Ranges Up to $\pm 10V$ SPI Interface   |
| LTC2755                     | Quad 16-/14-/12-Bit $I_{OUT}$ DACs with $\pm 1$ LSB INL, $\pm 1$ LSB DNL     | Software Programmable Output Ranges Up to $\pm 10V$ , Parallel Interface  |

2654f