

3A High-Speed MOSFET Drivers

Features

- Latch-Up Protected: Will Withstand 500 mA Reverse Current
- Input Will Withstand Negative Inputs Up to 5V
- ESD Protected: 4 kV
- High Peak Output Current: 3A
- Wide Input Supply Voltage Operating Range:
 - 4.5V to 16V
- High Capacitive Load Drive Capability:
 - 1800 pF in 20 nsec
- Short Delay Time: 35 nsec Typ
- Matched Delay Times
- Low Supply Current
 - With Logic '1' Input: 500 μ A
 - With Logic '0' Input: 100 μ A
- Low Output Impedance: 2.7 Ω
- Available in Space-Saving 8-pin MSOP Package
- Pinout Same as TC1410/TC1411/TC1412

General Description

The TC1413/TC1413N are 3A CMOS buffers/drivers. They will not latch-up under any conditions within their power and voltage ratings. They are not subject to damage when up to 5V of noise spiking of either polarity occurs on the ground pin. They can accept, without damage or logic upset, up to 500 mA of current of either polarity being forced back into their output. All terminals are fully protected against up to 4 kV of electrostatic discharge.

As MOSFET drivers, the TC1413/TC1413N can easily charge an 1800 pF gate capacitance in 20 nsec with matched rise and fall times, and provide low enough impedance in both the ON and the OFF states to ensure the MOSFET's intended state will not be affected, even by large transients. The leading and trailing edge propagation delay times are also matched to allow driving short-duration inputs with greater accuracy.

Applications

- Switch Mode Power Supplies
- Line Drivers
- Pulse Transformer Drive
- Relay Driver

Package Type



TC1413/TC1413N

Functional Block Diagram



1.0 ELECTRICAL CHARACTERISTICS

Absolute Maximum Ratings†

| | |
|---|---------------------------------|
| Supply Voltage | +20V |
| Input Voltage | $V_{DD} + 0.3V$ to $GND - 5.0V$ |
| Power Dissipation ($T_A \leq 70^\circ C$) | |
| MSOP | 340 mW |
| PDIP | 730 mW |
| SOIC..... | 470 mW |
| Storage Temperature Range..... | $-65^\circ C$ to $+150^\circ C$ |
| Maximum Junction Temperature..... | $+150^\circ C$ |

† Stresses above those listed under "Absolute Maximum Ratings" may cause permanent damage to the device. These are stress ratings only and functional operation of the device at these or any other conditions above those indicated in the operation sections of the specifications is not implied. Exposure to Absolute Maximum Rating conditions for extended periods may affect device reliability.

PIN FUNCTION TABLE

| Symbol | Description |
|----------|--|
| V_{DD} | Supply input, 4.5V to 16V |
| INPUT | Control input |
| NC | No connection |
| GND | Ground |
| GND | Ground |
| OUTPUT | CMOS push-pull output, common to pin 7 |
| OUTPUT | CMOS push-pull output, common to pin 6 |
| V_{DD} | Supply input, 4.5V to 16V |

DC ELECTRICAL CHARACTERISTICS

Electrical Specifications: Unless otherwise noted, over operating temperature range with $4.5V \leq V_{DD} \leq 16V$. Typical values are measured at $T_A = +25^\circ C$, $V_{DD} = 16V$.

| Parameters | Sym | Min | Typ | Max | Units | Conditions |
|---|-----------|------------------|-------------------|-------------------|----------|--|
| Input | | | | | | |
| Logic '1', High Input Voltage | V_{IH} | 2.0 | — | — | V | |
| Logic '0', Low Input Voltage | V_{IL} | — | — | 0.8 | V | |
| Input Current | I_{IN} | -1.0 -10 | — | 1.0 10 | μA | $0V \leq V_{IN} \leq V_{DD}$, $T_A = +25^\circ C$ $-40^\circ C \leq T_A \leq +85^\circ C$ |
| Output | | | | | | |
| High Output Voltage | V_{OH} | $V_{DD} - 0.025$ | — | — | V | DC Test |
| Low Output Voltage | V_{OL} | — | — | 0.025 | V | DC Test |
| Output Resistance | R_O | — | 2.7 3.3 3.3 | 4.0 5.0 5.0 | Ω | $V_{DD} = 16V$, $I_O = 10 mA$, $T_A = +25^\circ C$ $0^\circ C \leq T_A \leq +70^\circ C$ $-40^\circ C \leq T_A \leq +85^\circ C$ |
| Peak Output Current | I_{PK} | — | 3.0 | — | A | $V_{DD} = 16V$ |
| Latch-Up Protection Withstand Reverse Current | I_{REV} | — | 0.5 | — | A | Duty cycle $\leq 2\%$, $t \leq 300 \mu sec$, $V_{DD} = 16V$ |
| Switching Time (Note 1) | | | | | | |
| Rise Time | t_R | — | 20 22 24 | 28 33 33 | nsec | $T_A = +25^\circ C$ $0^\circ C \leq T_A \leq +70^\circ C$ $-40^\circ C \leq T_A \leq +85^\circ C$, Figure 4-1 |
| Fall Time | t_F | — | 20 22 24 | 28 33 33 | nsec | $T_A = +25^\circ C$ $0^\circ C \leq T_A \leq +70^\circ C$ $-40^\circ C \leq T_A \leq +85^\circ C$, Figure 4-1 |

Note 1: Switching times ensured by design.

TC1413/TC1413N

DC ELECTRICAL CHARACTERISTICS (CONTINUED)

Electrical Specifications: Unless otherwise noted, over operating temperature range with $4.5V \leq V_{DD} \leq 16V$. Typical values are measured at $T_A = +25^\circ C$, $V_{DD} = 16V$.

| Parameters | Sym | Min | Typ | Max | Units | Conditions |
|----------------------|----------|-----|-----|------|-------|---|
| Delay Time | t_{D1} | — | 35 | 45 | nsec | $T_A = +25^\circ C$, $0^\circ C \leq T_A \leq +70^\circ C$ $-40^\circ C \leq T_A \leq +85^\circ C$, Figure 4-1 |
| | | — | 40 | 50 | | |
| | | — | 40 | 50 | | |
| Delay Time | t_{D2} | — | 35 | 45 | nsec | $T_A = +25^\circ C$ $0^\circ C \leq T_A \leq +70^\circ C$ $-40^\circ C \leq T_A \leq +85^\circ C$, Figure 4-1 |
| | | — | 40 | 50 | | |
| | | — | 40 | 50 | | |
| Power Supply | | | | | | |
| Power Supply Current | I_S | — | 0.5 | 1.0 | mA | $V_{IN} = 3V$, $V_{DD} = 16V$ $V_{IN} = 0V$ |
| | | — | 0.1 | 0.15 | | |

Note 1: Switching times ensured by design.

TEMPERATURE CHARACTERISTICS

Electrical Specifications: Unless otherwise noted, all parameters apply with $4.5V \leq V_{DD} \leq 18V$.

| Parameters | Sym | Min | Typ | Max | Units | Conditions |
|------------------------------------|---------------|-----|-----|------|--------------|------------|
| Temperature Ranges | | | | | | |
| Specified Temperature Range (C) | T_A | 0 | — | +70 | $^\circ C$ | |
| Specified Temperature Range (E) | T_A | -40 | — | +85 | $^\circ C$ | |
| Maximum Junction Temperature | T_J | — | — | +150 | $^\circ C$ | |
| Storage Temperature Range | T_A | -65 | — | +150 | $^\circ C$ | |
| Package Thermal Resistances | | | | | | |
| Thermal Resistance, 8L-MSOP | θ_{JA} | — | 206 | — | $^\circ C/W$ | |
| Thermal Resistance, 8L-PDIP | θ_{JA} | — | 125 | — | $^\circ C/W$ | |
| Thermal Resistance, 8L-SOIC | θ_{JA} | — | 155 | — | $^\circ C/W$ | |

2.0 TYPICAL PERFORMANCE CURVES

Note: The graphs and tables provided following this note are a statistical summary based on a limited number of samples and are provided for informational purposes only. The performance characteristics listed herein are not tested or guaranteed. In some graphs or tables, the data presented may be outside the specified operating range (e.g., outside specified power supply range) and therefore outside the warranted range.

Note: Unless otherwise indicated, over operating temperature range with $4.5V \leq V_{DD} \leq 16V$.



FIGURE 2-1: Quiescent Supply Current vs. Supply Voltage.

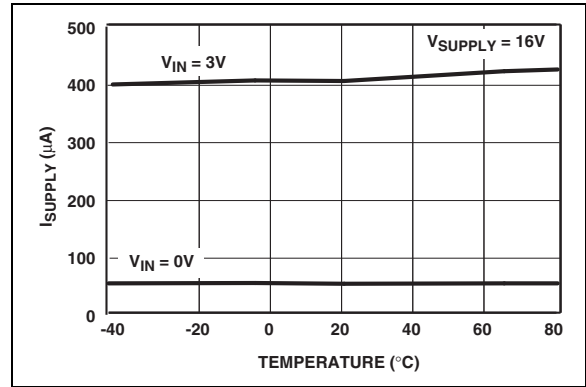

FIGURE 2-4: Quiescent Supply Current vs. Temperature.



FIGURE 2-2: Input Threshold vs. Supply Voltage.

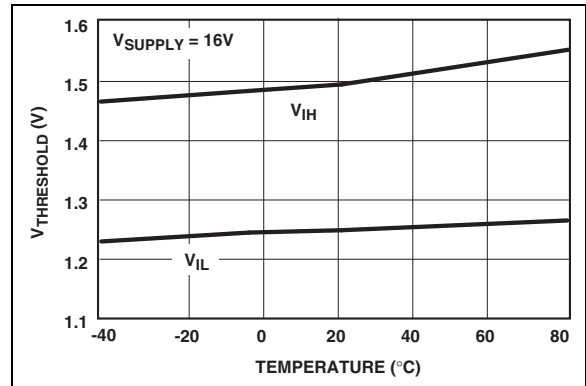

FIGURE 2-5: Input Threshold vs. Temperature.

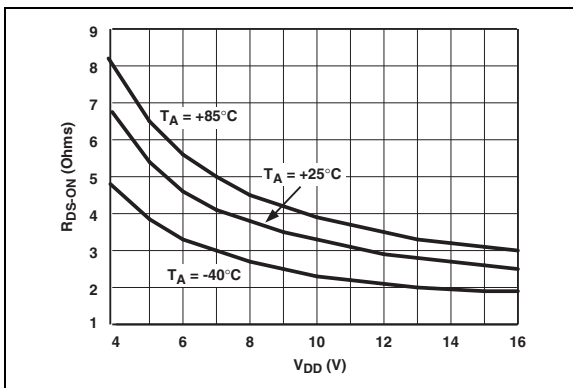

FIGURE 2-3: High-State Output Resistance vs. Supply Voltage

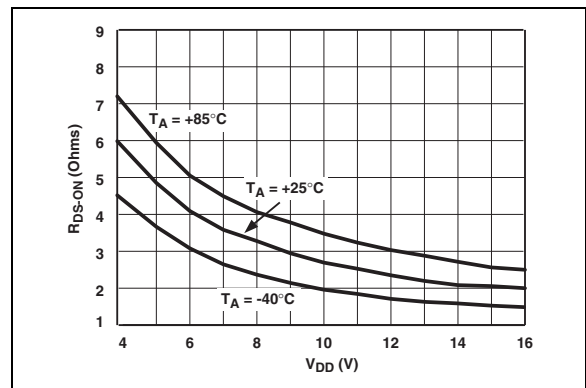

FIGURE 2-6: Low-State Output Resistance vs. Supply Voltage

TC1413/TC1413N

Note: Unless otherwise indicated, over operating temperature range with $4.5V \leq V_{DD} \leq 16V$.



FIGURE 2-7: Rise Time vs. Supply Voltage.



FIGURE 2-10: Fall Time vs. Supply Voltage.



FIGURE 2-8: Propagation Delay vs. Supply Voltage.



FIGURE 2-11: Propagation Delay vs. Supply Voltage.



FIGURE 2-9: Rise and Fall Times vs. Capacitive Load.



FIGURE 2-12: Propagation Delays vs. Capacitive Load.

3.0 PIN DESCRIPTIONS

The descriptions of the pins are listed in Table 3-1.

TABLE 3-1: PIN FUNCTION TABLE

| Pin No. | Symbol | Description |
|---------|-----------------|--|
| 1 | V _{DD} | Supply input, 4.5V to 16V |
| 2 | INPUT | Control input |
| 3 | NC | No connection |
| 4 | GND | Ground |
| 5 | GND | Ground |
| 6 | OUTPUT | CMOS push-pull output, common to pin 7 |
| 7 | OUTPUT | CMOS push-pull output, common to pin 6 |
| 8 | V _{DD} | Supply input, 4.5V to 16V |

3.1 Supply Input (V_{DD})

The V_{DD} input is the bias supply for the MOSFET driver and is rated for 4.5V to 16V with respect to the ground pin. The V_{DD} input should be bypassed to ground with a local ceramic capacitor. The value of the capacitor should be chosen based on the capacitive load that is being driven. A value of 1.0 μ F is suggested.

3.2 Control Input (INPUT)

The MOSFET driver input is a high-impedance, TTL/CMOS-compatible input. The input has 300 mV of hysteresis between the high and low thresholds which prevents output glitching even when the rise and fall time of the input signal is very slow.

3.3 CMOS Push-Pull Output (OUTPUT)

The MOSFET driver output is a low-impedance, CMOS push-pull style output, capable of driving a capacitive load with 3A peak currents.

3.4 Ground (GND)

The ground pins are the return path for the bias current and for the high peak currents that discharge the load capacitor. The ground pins should be tied into a ground plane or have very short traces to the bias supply source return.

3.5 No Connect (NC)

No internal connection.

TC1413/TC1413N

4.0 APPLICATION INFORMATION



FIGURE 4-1: Switching Time Test Circuit.

5.0 PACKAGING INFORMATION

5.1 Package Marking Information

8-Lead PDIP (300 mil)



Example:

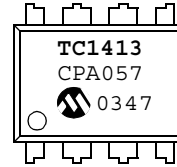

8-Lead SOIC (150 mil)



Example:

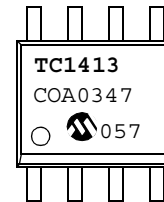

8-Lead MSOP

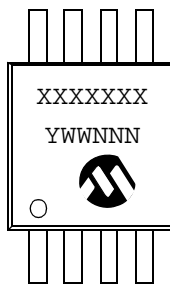

Example:



| | | |
|----------------|--------|--|
| Legend: | XX...X | Customer-specific information |
| | Y | Year code (last digit of calendar year) |
| | YY | Year code (last 2 digits of calendar year) |
| | WW | Week code (week of January 1 is week '01') |
| | NNN | Alphanumeric traceability code |
| | (e3) | Pb-free JEDEC designator for Matte Tin (Sn) |
| | * | This package is Pb-free. The Pb-free JEDEC designator (e3) can be found on the outer packaging for this package. |

Note: In the event the full Microchip part number cannot be marked on one line, it will be carried over to the next line, thus limiting the number of available characters for customer-specific information.

TC1413/TC1413N

8-Lead Plastic Dual In-line (PA) – 300 mil (PDIP)

Note: For the most current package drawings, please see the Microchip Packaging Specification located at <http://www.microchip.com/packaging>



| Units | | INCHES* | | | MILLIMETERS | | |
|----------------------------|------|---------|------|------|-------------|------|-------|
| Dimension Limits | | MIN | NOM | MAX | MIN | NOM | MAX |
| Number of Pins | n | | 8 | | | 8 | |
| Pitch | p | | .100 | | | 2.54 | |
| Top to Seating Plane | A | .140 | .155 | .170 | 3.56 | 3.94 | 4.32 |
| Molded Package Thickness | A2 | .115 | .130 | .145 | 2.92 | 3.30 | 3.68 |
| Base to Seating Plane | A1 | .015 | | | 0.38 | | |
| Shoulder to Shoulder Width | E | .300 | .313 | .325 | 7.62 | 7.94 | 8.26 |
| Molded Package Width | E1 | .240 | .250 | .260 | 6.10 | 6.35 | 6.60 |
| Overall Length | D | .360 | .373 | .385 | 9.14 | 9.46 | 9.78 |
| Tip to Seating Plane | L | .125 | .130 | .135 | 3.18 | 3.30 | 3.43 |
| Lead Thickness | c | .008 | .012 | .015 | 0.20 | 0.29 | 0.38 |
| Upper Lead Width | B1 | .045 | .058 | .070 | 1.14 | 1.46 | 1.78 |
| Lower Lead Width | B | .014 | .018 | .022 | 0.36 | 0.46 | 0.56 |
| Overall Row Spacing | § eB | .310 | .370 | .430 | 7.87 | 9.40 | 10.92 |
| Mold Draft Angle Top | α | 5 | 10 | 15 | 5 | 10 | 15 |
| Mold Draft Angle Bottom | β | 5 | 10 | 15 | 5 | 10 | 15 |

* Controlling Parameter

§ Significant Characteristic

Notes:

Dimensions D and E1 do not include mold flash or protrusions. Mold flash or protrusions shall not exceed .010" (0.254mm) per side.

JEDEC Equivalent: MS-001

Drawing No. C04-018

TC1413/TC1413N

8-Lead Plastic Small Outline (OA) – Narrow, 150 mil (SOIC)

Note: For the most current package drawings, please see the Microchip Packaging Specification located at <http://www.microchip.com/packaging>



| Dimension | Units | INCHES* | | | MILLIMETERS | | |
|--------------------------|-------|---------|------|------|-------------|------|------|
| | | MIN | NOM | MAX | MIN | NOM | MAX |
| Number of Pins | n | | 8 | | | 8 | |
| Pitch | p | | .050 | | | 1.27 | |
| Overall Height | A | .053 | .061 | .069 | 1.35 | 1.55 | 1.75 |
| Molded Package Thickness | A2 | .052 | .056 | .061 | 1.32 | 1.42 | 1.55 |
| Standoff § | A1 | .004 | .007 | .010 | 0.10 | 0.18 | 0.25 |
| Overall Width | E | .228 | .237 | .244 | 5.79 | 6.02 | 6.20 |
| Molded Package Width | E1 | .146 | .154 | .157 | 3.71 | 3.91 | 3.99 |
| Overall Length | D | .189 | .193 | .197 | 4.80 | 4.90 | 5.00 |
| Chamfer Distance | h | .010 | .015 | .020 | 0.25 | 0.38 | 0.51 |
| Foot Length | L | .019 | .025 | .030 | 0.48 | 0.62 | 0.76 |
| Foot Angle | φ | 0 | 4 | 8 | 0 | 4 | 8 |
| Lead Thickness | c | .008 | .009 | .010 | 0.20 | 0.23 | 0.25 |
| Lead Width | B | .013 | .017 | .020 | 0.33 | 0.42 | 0.51 |
| Mold Draft Angle Top | α | 0 | 12 | 15 | 0 | 12 | 15 |
| Mold Draft Angle Bottom | β | 0 | 12 | 15 | 0 | 12 | 15 |

* Controlling Parameter
 § Significant Characteristic

Notes:
 Dimensions D and E1 do not include mold flash or protrusions. Mold flash or protrusions shall not exceed .010" (0.254mm) per side.
 JEDEC Equivalent: MS-012
 Drawing No. C04-057

TC1413/TC1413N

8-Lead Plastic Micro Small Outline Package (UA) (MSOP)

Note: For the most current package drawings, please see the Microchip Packaging Specification located at <http://www.microchip.com/packaging>

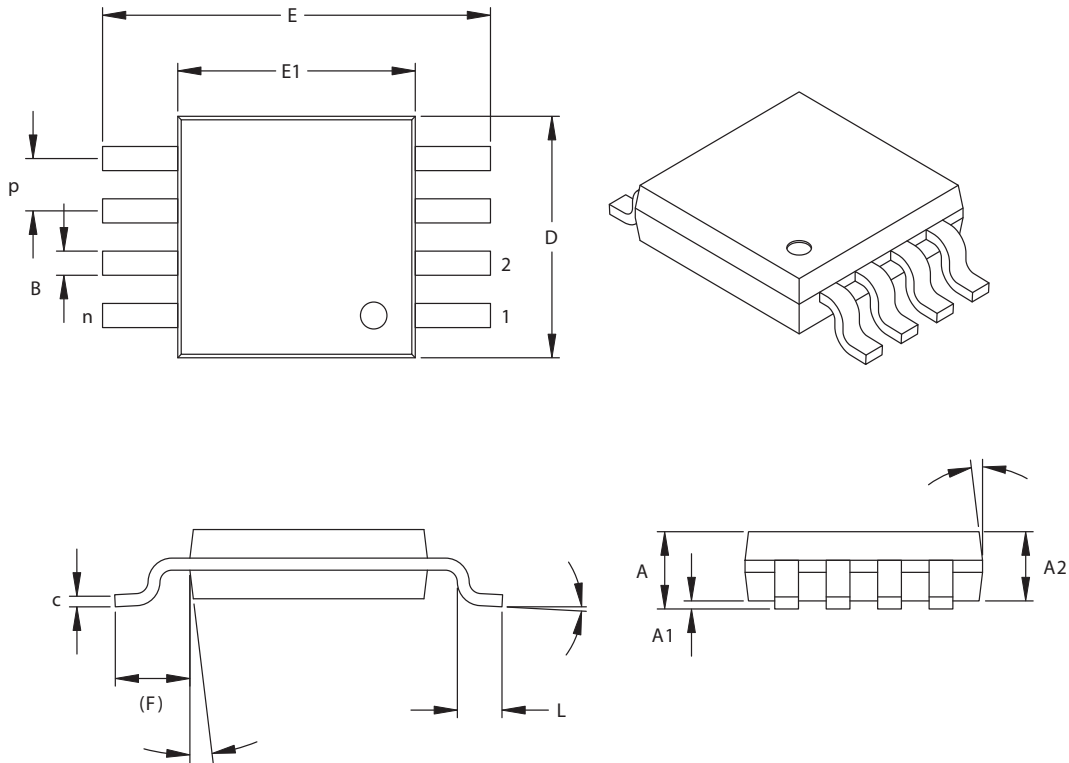

| Units | | INCHES | | | MILLIMETERS* | | |
|--------------------------|----|----------|------|------|--------------|------|------|
| Dimension Limits | | MIN | NOM | MAX | MIN | NOM | MAX |
| Number of Pins | n | | 8 | | | 8 | |
| Pitch | P | .026 BSC | | | 0.65 BSC | | |
| Overall Height | A | - | - | .043 | - | - | 1.10 |
| Molded Package Thickness | A2 | .030 | .033 | .037 | 0.75 | 0.85 | 0.95 |
| Standoff | A1 | .000 | - | .006 | 0.00 | - | 0.15 |
| Overall Width | E | .193 BSC | | | 4.90 BSC | | |
| Molded Package Width | E1 | .118 BSC | | | 3.00 BSC | | |
| Overall Length | D | .118 BSC | | | 3.00 BSC | | |
| Foot Length | L | .016 | .024 | .031 | 0.40 | 0.60 | 0.80 |
| Footprint (Reference) | F | .037 REF | | | 0.95 REF | | |
| Foot Angle | | 0° | - | 8° | 0° | - | 8° |
| Lead Thickness | c | .003 | .006 | .009 | 0.08 | - | 0.23 |
| Lead Width | B | .009 | .012 | .016 | 0.22 | - | 0.40 |
| Mold Draft Angle Top | | 5° | - | 15° | 5° | - | 15° |
| Mold Draft Angle Bottom | | 5° | - | 15° | 5° | - | 15° |

*Controlling Parameter

Notes:

Dimensions D and E1 do not include mold flash or protrusions. Mold flash or protrusions shall not exceed .010" (0.254mm) per side.

JEDEC Equivalent: MO-187

Drawing No. C04-111

6.0 REVISION HISTORY

Revision D (December 2012)

Added a note to each package outline drawing.

TC1413/TC1413N

NOTES:

PRODUCT IDENTIFICATION SYSTEM

To order or obtain information, e.g., on pricing or delivery, refer to the factory or the listed sales office.

| <u>PART NO.</u> | <u>X</u> | <u>/XX</u> |
|--------------------|--|------------|
| Device | Temperature Range | Package |
| Device: | TC1413: 3 A Single MOSFET Driver, Inverting TC1413N: 3 A Single MOSFET Driver, Non-Inverting | |
| Temperature Range: | C = 0°C to +70°C E = -40°C to +85°C | |
| Package: | OA = Plastic SOIC, (150 mil Body), 8-lead OA713 = Plastic SOIC, (150 mil Body), 8-lead (Tape and Reel) UA = Plastic Micro Small Outline (MSOP), 8-lead * UA713 = Plastic Micro Small Outline (MSOP), 8-lead * (Tape and Reel) PA = Plastic DIP (300 mil Body), 8-lead * MSOP package is only available in E-Temp. | |

Examples:

a) TC1413COA: 3A Single MOSFET driver, SOIC package, 0°C to +70°C.

b) TC1413CPA: 3A Single MOSFET driver, PDIP package, 0°C to +70°C.

c) TC1413EUA713: Tape and Reel, 3A Single MOSFET driver, MSOP package, -40°C to +85°C.

a) TC1413NCPA: 3A Single MOSFET driver, PDIP package, 0°C to +70°C.

b) TC1413NEPA: 3A Single MOSFET driver, PDIP package, -40°C to +85°C.

c) TC1413NEUA: 3A Single MOSFET driver, MSOP package, -40°C to +85°C.

Sales and Support

Data Sheets

Products supported by a preliminary Data Sheet may have an errata sheet describing minor operational differences and recommended workarounds. To determine if an errata sheet exists for a particular device, please contact one of the following:

1. Your local Microchip sales office
2. The Microchip Worldwide Site (www.microchip.com)

Please specify which device, revision of silicon and Data Sheet (include Literature #) you are using.

Customer Notification System

Register on our web site (www.microchip.com/cn) to receive the most current information on our products.

TC1413/TC1413N

NOTES:

Note the following details of the code protection feature on Microchip devices:

- Microchip products meet the specification contained in their particular Microchip Data Sheet.
- Microchip believes that its family of products is one of the most secure families of its kind on the market today, when used in the intended manner and under normal conditions.
- There are dishonest and possibly illegal methods used to breach the code protection feature. All of these methods, to our knowledge, require using the Microchip products in a manner outside the operating specifications contained in Microchip's Data Sheets. Most likely, the person doing so is engaged in theft of intellectual property.
- Microchip is willing to work with the customer who is concerned about the integrity of their code.
- Neither Microchip nor any other semiconductor manufacturer can guarantee the security of their code. Code protection does not mean that we are guaranteeing the product as “unbreakable.”

Code protection is constantly evolving. We at Microchip are committed to continuously improving the code protection features of our products. Attempts to break Microchip's code protection feature may be a violation of the Digital Millennium Copyright Act. If such acts allow unauthorized access to your software or other copyrighted work, you may have a right to sue for relief under that Act.

Information contained in this publication regarding device applications and the like is provided only for your convenience and may be superseded by updates. It is your responsibility to ensure that your application meets with your specifications. MICROCHIP MAKES NO REPRESENTATIONS OR WARRANTIES OF ANY KIND WHETHER EXPRESS OR IMPLIED, WRITTEN OR ORAL, STATUTORY OR OTHERWISE, RELATED TO THE INFORMATION, INCLUDING BUT NOT LIMITED TO ITS CONDITION, QUALITY, PERFORMANCE, MERCHANTABILITY OR FITNESS FOR PURPOSE. Microchip disclaims all liability arising from this information and its use. Use of Microchip devices in life support and/or safety applications is entirely at the buyer's risk, and the buyer agrees to defend, indemnify and hold harmless Microchip from any and all damages, claims, suits, or expenses resulting from such use. No licenses are conveyed, implicitly or otherwise, under any Microchip intellectual property rights.

Trademarks

The Microchip name and logo, the Microchip logo, dsPIC, FlashFlex, KEELOQ, KEELOQ logo, MPLAB, PIC, PICmicro, PICSTART, PIC³² logo, rPIC, SST, SST Logo, SuperFlash and UNI/O are registered trademarks of Microchip Technology Incorporated in the U.S.A. and other countries.

FilterLab, Hampshire, HI-TECH C, Linear Active Thermistor, MTP, SEEVAL and The Embedded Control Solutions Company are registered trademarks of Microchip Technology Incorporated in the U.S.A.

Silicon Storage Technology is a registered trademark of Microchip Technology Inc. in other countries.

Analog-for-the-Digital Age, Application Maestro, BodyCom, chipKIT, chipKIT logo, CodeGuard, dsPICDEM, dsPICDEM.net, dsPICworks, dsSPEAK, ECAN, ECONOMONITOR, FanSense, HI-TIDE, In-Circuit Serial Programming, ICSP, Mindi, MiWi, MPASM, MPF, MPLAB Certified logo, MPLIB, MPLINK, mTouch, Omniclient Code Generation, PICC, PICC-18, PICDEM, PICDEM.net, PICkit, PICTail, REAL ICE, rLAB, Select Mode, SQI, Serial Quad I/O, Total Endurance, TSHARC, UniWinDriver, WiperLock, ZENA and Z-Scale are trademarks of Microchip Technology Incorporated in the U.S.A. and other countries.

SQTP is a service mark of Microchip Technology Incorporated in the U.S.A.

GestIC and ULPP are registered trademarks of Microchip Technology Germany II GmbH & Co. & KG, a subsidiary of Microchip Technology Inc., in other countries.

All other trademarks mentioned herein are property of their respective companies.

© 2001-2012, Microchip Technology Incorporated, Printed in the U.S.A., All Rights Reserved.

 Printed on recycled paper.

ISBN: 9781620767870

QUALITY MANAGEMENT SYSTEM
CERTIFIED BY DNV
== ISO/TS 16949 ==

Microchip received ISO/TS-16949:2009 certification for its worldwide headquarters, design and wafer fabrication facilities in Chandler and Tempe, Arizona; Gresham, Oregon and design centers in California and India. The Company's quality system processes and procedures are for its PIC[®] MCUs and dsPIC[®] DSCs, KEELOQ[®] code hopping devices, Serial EEPROMs, microperipherals, nonvolatile memory and analog products. In addition, Microchip's quality system for the design and manufacture of development systems is ISO 9001:2000 certified.



MICROCHIP

Worldwide Sales and Service

AMERICAS

Corporate Office
2355 West Chandler Blvd.
Chandler, AZ 85224-6199
Tel: 480-792-7200
Fax: 480-792-7277
Technical Support:
<http://www.microchip.com/support>
Web Address:
www.microchip.com

Atlanta
Duluth, GA
Tel: 678-957-9614
Fax: 678-957-1455

Boston
Westborough, MA
Tel: 774-760-0087
Fax: 774-760-0088

Chicago
Itasca, IL
Tel: 630-285-0071
Fax: 630-285-0075

Cleveland
Independence, OH
Tel: 216-447-0464
Fax: 216-447-0643

Dallas
Addison, TX
Tel: 972-818-7423
Fax: 972-818-2924

Detroit
Farmington Hills, MI
Tel: 248-538-2250
Fax: 248-538-2260

Indianapolis
Noblesville, IN
Tel: 317-773-8323
Fax: 317-773-5453

Los Angeles
Mission Viejo, CA
Tel: 949-462-9523
Fax: 949-462-9608

Santa Clara
Santa Clara, CA
Tel: 408-961-6444
Fax: 408-961-6445

Toronto
Mississauga, Ontario,
Canada
Tel: 905-673-0699
Fax: 905-673-6509

ASIA/PACIFIC

Asia Pacific Office
Suites 3707-14, 37th Floor
Tower 6, The Gateway
Harbour City, Kowloon
Hong Kong
Tel: 852-2401-1200
Fax: 852-2401-3431

Australia - Sydney
Tel: 61-2-9868-6733
Fax: 61-2-9868-6755

China - Beijing
Tel: 86-10-8569-7000
Fax: 86-10-8528-2104

China - Chengdu
Tel: 86-28-8665-5511
Fax: 86-28-8665-7889

China - Chongqing
Tel: 86-23-8980-9588
Fax: 86-23-8980-9500

China - Hangzhou
Tel: 86-571-2819-3187
Fax: 86-571-2819-3189

China - Hong Kong SAR
Tel: 852-2943-5100
Fax: 852-2401-3431

China - Nanjing
Tel: 86-25-8473-2460
Fax: 86-25-8473-2470

China - Qingdao
Tel: 86-532-8502-7355
Fax: 86-532-8502-7205

China - Shanghai
Tel: 86-21-5407-5533
Fax: 86-21-5407-5066

China - Shenyang
Tel: 86-24-2334-2829
Fax: 86-24-2334-2393

China - Shenzhen
Tel: 86-755-8864-2200
Fax: 86-755-8203-1760

China - Wuhan
Tel: 86-27-5980-5300
Fax: 86-27-5980-5118

China - Xian
Tel: 86-29-8833-7252
Fax: 86-29-8833-7256

China - Xiamen
Tel: 86-592-2388138
Fax: 86-592-2388130

China - Zhuhai
Tel: 86-756-3210040
Fax: 86-756-3210049

ASIA/PACIFIC

India - Bangalore
Tel: 91-80-3090-4444
Fax: 91-80-3090-4123

India - New Delhi
Tel: 91-11-4160-8631
Fax: 91-11-4160-8632

India - Pune
Tel: 91-20-2566-1512
Fax: 91-20-2566-1513

Japan - Osaka
Tel: 81-66-152-7160
Fax: 81-66-152-9310

Japan - Yokohama
Tel: 81-45-471-6166
Fax: 81-45-471-6122

Korea - Daegu
Tel: 82-53-744-4301
Fax: 82-53-744-4302

Korea - Seoul
Tel: 82-2-554-7200
Fax: 82-2-558-5932 or
82-2-558-5934

Malaysia - Kuala Lumpur
Tel: 60-3-6201-9857
Fax: 60-3-6201-9859

Malaysia - Penang
Tel: 60-4-227-8870
Fax: 60-4-227-4068

Philippines - Manila
Tel: 63-2-634-9065
Fax: 63-2-634-9069

Singapore
Tel: 65-6334-8870
Fax: 65-6334-8850

Taiwan - Hsin Chu
Tel: 886-3-5778-366
Fax: 886-3-5770-955

Taiwan - Kaohsiung
Tel: 886-7-213-7828
Fax: 886-7-330-9305

Taiwan - Taipei
Tel: 886-2-2508-8600
Fax: 886-2-2508-0102

Thailand - Bangkok
Tel: 66-2-694-1351
Fax: 66-2-694-1350

EUROPE

Austria - Wels
Tel: 43-7242-2244-39
Fax: 43-7242-2244-393

Denmark - Copenhagen
Tel: 45-4450-2828
Fax: 45-4485-2829

France - Paris
Tel: 33-1-69-53-63-20
Fax: 33-1-69-30-90-79

Germany - Munich
Tel: 49-89-627-144-0
Fax: 49-89-627-144-44

Italy - Milan
Tel: 39-0331-742611
Fax: 39-0331-466781

Netherlands - Drunen
Tel: 31-416-690399
Fax: 31-416-690340

Spain - Madrid
Tel: 34-91-708-08-90
Fax: 34-91-708-08-91

UK - Wokingham
Tel: 44-118-921-5869
Fax: 44-118-921-5820

11/27/12