

CMPA801B025

25 W, 8.5 - 11.0 GHz, GaN MMIC, Power Amplifier

Cree's CMPA801B025 is a gallium nitride (GaN) High Electron Mobility Transistor (HEMT) based monolithic microwave integrated circuit (MMIC). GaN has superior properties compared to silicon or gallium arsenide, including higher breakdown voltage, higher saturated electron drift velocity and higher thermal conductivity. GaN HEMTs also offer greater power density and wider bandwidths compared to Si and GaAs transistors. This MMIC is available in a 10-lead metal/ceramic flanged package (CMPA801B025F) or small form-factor pill package (CMPA801B025P) for optimal electrical and thermal performance.

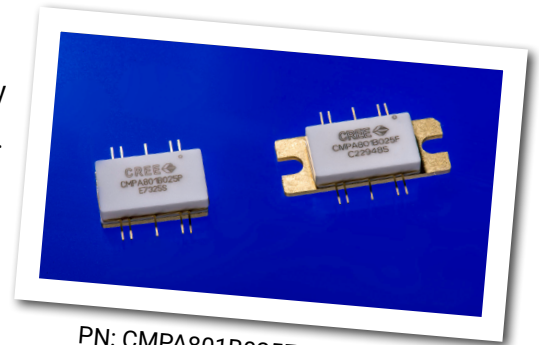

PN: CMPA801B025F/ CMPA801B025P
Package Type: 440208 / 440216

Typical Performance Over 8.5-11.0 GHz ($T_c = 25^\circ\text{C}$)

Parameter	8.5 GHz	10.0 GHz	11.0 GHz	Units
Output Power ¹	38.0	37.0	35.5	W
Output Power ¹	45.8	45.7	45.5	dBm
Power Added Efficiency ¹	37.0	36.0	35.0	%

Note¹: Measured in CMPA801B025F-AMP under 100 μs pulse width, 10% duty.

Features

- 8.5 - 11.0 GHz Operation
- 37 W P_{OUT} typical
- 16 dB Power Gain
- 36 % Typical PAE
- 50 Ohm internally matched
- <0.1 dB Power droop

Applications

- Marine Radar
- Communications
- Satellite Communication Uplink

Absolute Maximum Ratings (not simultaneous)

Parameter	Symbol	Rating	Units	Conditions
Drain-source Voltage	V_{DS}	84	V_{DC}	25°C
Gate-source Voltage	V_{GS}	-10, +2	V_{DC}	25°C
Power Dissipation	P_{DISS}	77	W	
Storage Temperature	T_{STG}	-55, +150	°C	
Operating Junction Temperature	T_J	225	°C	
Maximum Forward Gate Current	I_{GMAX}	13	mA	25°C
Soldering Temperature ¹	T_S	245	°C	
Screw Torque	τ	40	in-oz	
Thermal Resistance, Junction to Case	$R_{\theta JC}$	1.22	°C/W	Pulse Width = 100 μ s, Duty Cycle = 10%, $P_{DISS} = 55$ W
Thermal Resistance, Junction to Case	$R_{\theta JC}$	1.80	°C/W	CW, $P_{DISS} = 55$ W, 85°C
Case Operating Temperature	T_C	-40, +130	°C	Pulse Width = 100 μ s, Duty Cycle = 10%, $P_{DISS} = 55$ W
Case Operating Temperature	T_C	-40, +90	°C	CW, $P_{DISS} = 55$ W

Note:

¹ Refer to the Application Note on soldering at www.cree.com/RF/Document-Library

Electrical Characteristics (Frequency = 8.5 GHz to 11.0 GHz unless otherwise stated; $T_C = 25^\circ\text{C}$)

Characteristics	Symbol	Min.	Typ.	Max.	Units	Conditions
DC Characteristics¹						
Gate Threshold	$V_{GS(TH)}$	-3.8	-3.0	-2.3	V	$V_{DS} = 10$ V, $I_D = 13.2$ mA
Gate Quiescent Voltage	V_Q	-	-2.7	-	V	$V_{DS} = 28$ V, $I_D = 1.2$ A
Saturated Drain Current ²	I_{DS}	10.6	13.0	-	A	$V_{DS} = 6.0$ V, $V_{GS} = 2.0$ V
Drain-Source Breakdown Voltage	V_{BD}	84	100	-	V	$V_{GS} = -8$ V, $I_D = 13.2$ mA
RF Characteristics³						
Small Signal Gain	S21	20	24	-	dB	$V_{DD} = 28$ V, $I_{DQ} = 1.2$ A, $P_{IN} = -20$ dBm
Input Return Loss	S11	-	-6.0	-	dB	$V_{DD} = 28$ V, $I_{DQ} = 1.2$ A
Output Return Loss	S22	-	-6.0	-	dB	$V_{DD} = 28$ V, $I_{DQ} = 1.2$ A
Output Mismatch Stress	VSWR	-	-	5:1	Ψ	No damage at all phase angles, $V_{DD} = 28$ V, $I_{DQ} = 1.2$ A, Pulse Width = 100 μ s, Duty Cycle = 10%, $P_{IN} = 30$ dBm

Notes:

¹ Measured on-wafer prior to packaging.

² Scaled from PCM data.

³ Measured in the CMPA801B025F-AMP.

Electrical Characteristics Continued... (T_c = 25°C)

Characteristics	Symbol	Min.	Typ.	Max.	Units	Conditions
RF Characteristics^{1,2}						
Output Power	P _{OUT1}	44.75	45.8	–	dBm	V _{DD} = 28 V, I _{DQ} = 1.2 A, Frequency = 8.5 GHz, P _{IN} = 30 dBm
Output Power	P _{OUT2}	44.75	45.7	–	dBm	V _{DD} = 28 V, I _{DQ} = 1.2 A, Frequency = 10.0 GHz, P _{IN} = 30 dBm
Output Power	P _{OUT3}	44.35	45.5	–	dBm	V _{DD} = 28 V, I _{DQ} = 1.2 A, Frequency = 11.0 GHz, P _{IN} = 30 dBm
Power Gain	G ₁	14.75	15.8	–	dB	V _{DD} = 28 V, I _{DQ} = 1.2 A, Frequency = 8.5 GHz, P _{IN} = 30 dBm
Power Gain	G ₂	14.75	15.7	–	dB	V _{DD} = 28 V, I _{DQ} = 1.2 A, Frequency = 10.0 GHz, P _{IN} = 30 dBm
Power Gain	G ₃	14.35	15.5	–	dB	V _{DD} = 28 V, I _{DQ} = 1.2 A, Frequency = 11.0 GHz, P _{IN} = 30 dBm
Power Added Efficiency	PAE ₁	29	37	–	%	V _{DD} = 28 V, I _{DQ} = 1.2 A, Frequency = 8.5 GHz, P _{IN} = 30 dBm
Power Added Efficiency	PAE ₂	29	36	–	%	V _{DD} = 28 V, I _{DQ} = 1.2 A, Frequency = 10.0 GHz, P _{IN} = 30 dBm
Power Added Efficiency	PAE ₃	27	35	–	%	V _{DD} = 28 V, I _{DQ} = 1.2 A, Frequency = 11.0 GHz, P _{IN} = 30 dBm
Pulse Amplitude Droop	D	–	0.1	–	dB	V _{DD} = 28 V, I _{DQ} = 1.2 A, Frequency = 8.5 - 11.0 GHz, P _{IN} = 30 dBm

Notes:

¹ Pulse Width = 100 μs, Duty Cycle = 10 %.

² Measured in CMPA801B025F-AMP.

Electrostatic Discharge (ESD) Classifications

Parameter	Symbol	Class	Test Methodology
Human Body Model	HBM	1A (> 250 V)	JEDEC JESD22 A114-D
Charge Device Model	CDM	II (200 < 500 V)	JEDEC JESD22 C101-C

CMPA801B025F Typical Performance

Figure 1. - Output Power, Gain and Power Added Efficiency vs. Frequency

$V_{DD} = 28\text{ V}$, $P_{IN} = 30\text{ dBm}$, $I_{DQ} = 1.2\text{ A}$
Pulse Width = 100 μs , Duty Cycle = 10 %

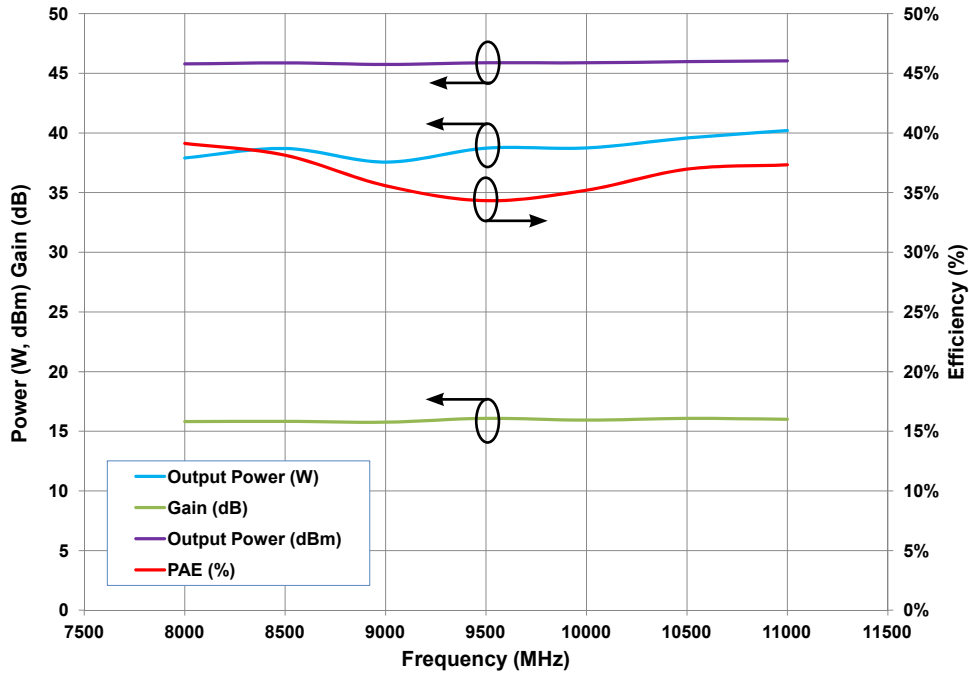
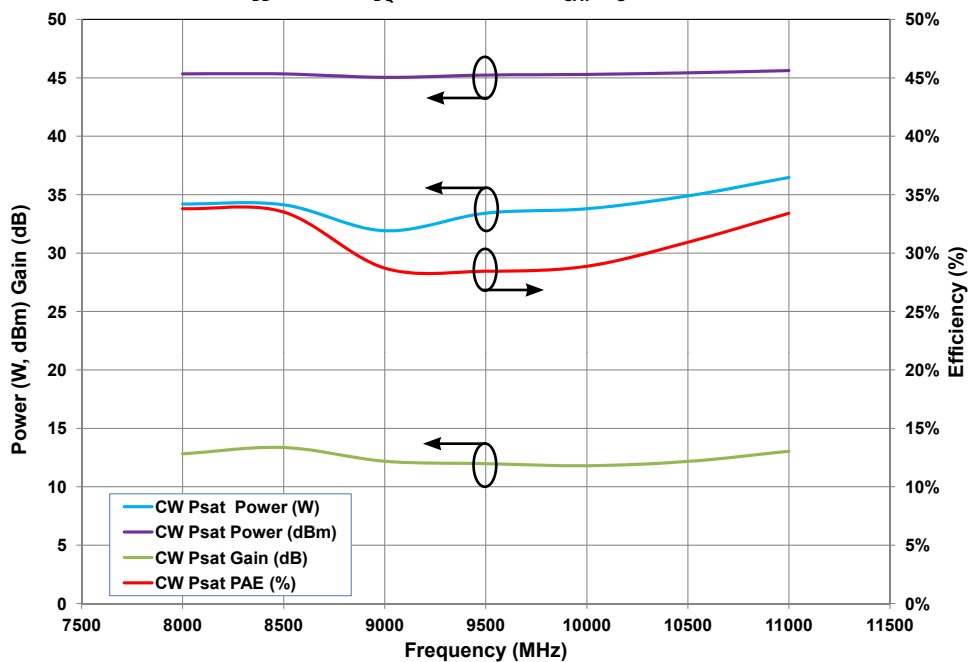

Figure 2. - Output Power, Gain and Power Added Efficiency vs. Frequency

$V_{DD} = 28\text{ V}$, $I_{DQ} = 1.2\text{ A}$, CW P_{SAT} ($I_G \approx 1.5\text{ mA}$)



CMPA801B025F Typical Performance

Figure 3. - Output Power, Gain and Power Added Efficiency vs. Input Power

$V_{DD} = 28\text{ V}$, $I_{DQ} = 1.2\text{ A}$, Frequency = 11 GHz

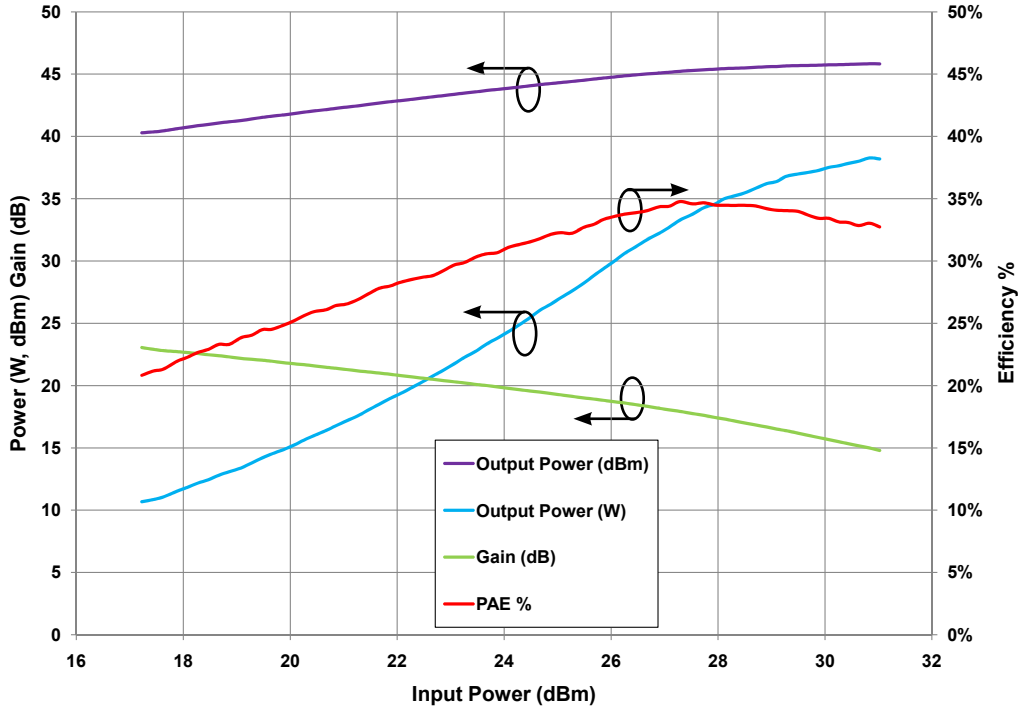
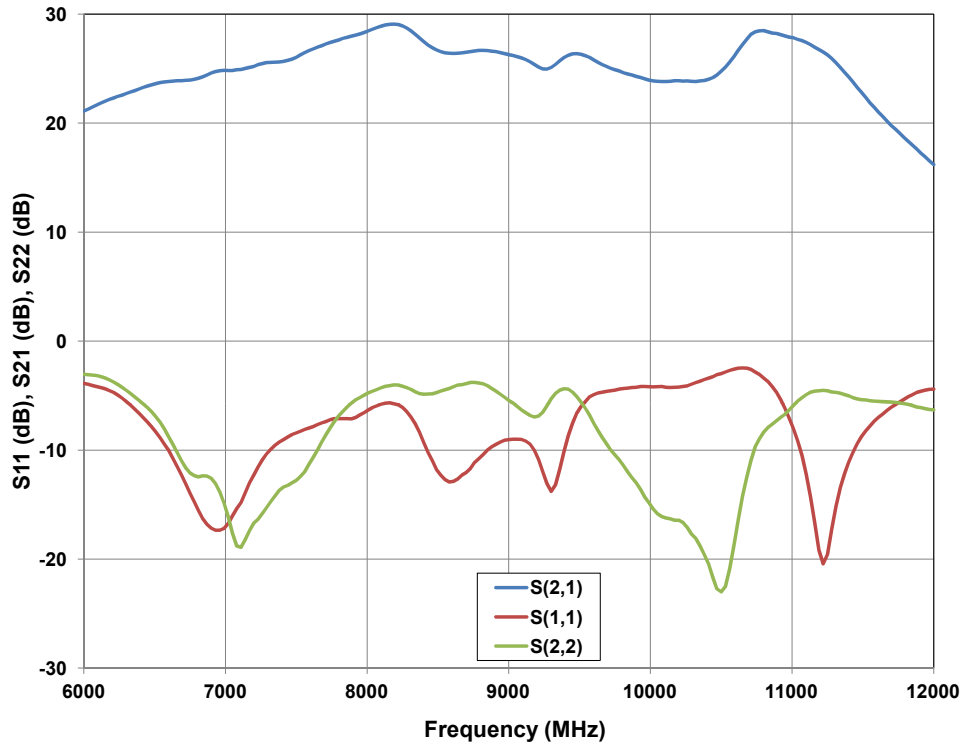
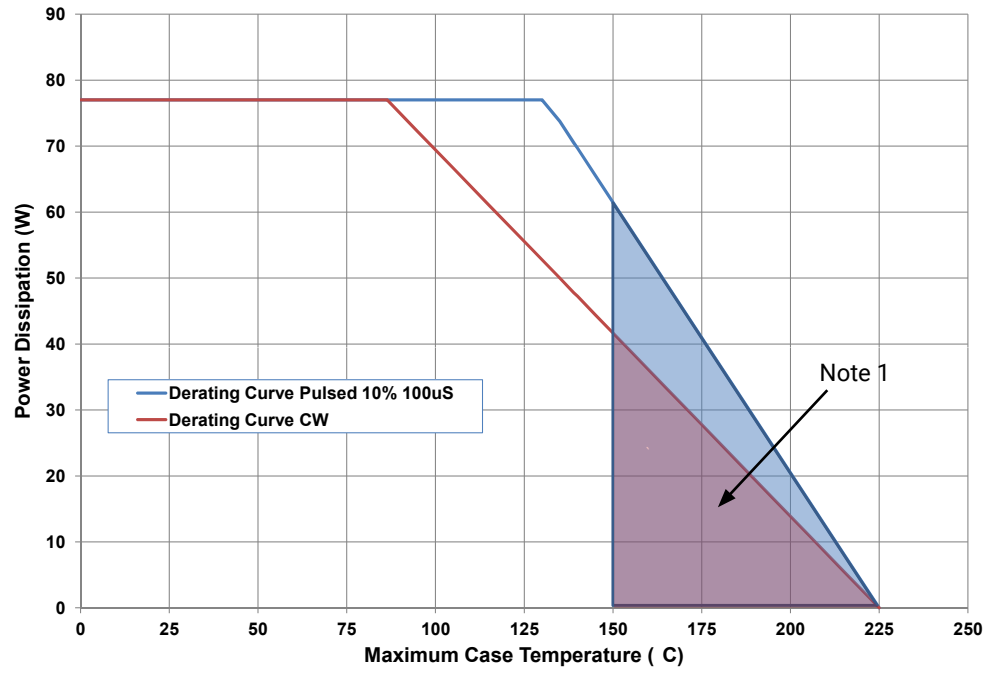

Figure 4. - Small Signal S-Parameters vs. Frequency



CMPA801B025F Typical Performance

Figure 5. - Power Dissipation Derating Curve



Note 1. Area exceeds Maximum Case Operating Temperature (See Page 2).

CMPA801B025F-AMP Demonstration Amplifier Circuit Bill of Materials

Designator	Description	Qty
C15	CAP ELECT 100UF 80V AFK SMD	1
R1, R2	RES 0.0 OHM 1/16W 0402 SMD	2
W1	WIRE, BLACK, 22 AWG ~ 1.50"	1
W2	WIRE, BLACK, 22 AWG ~ 1.75"	1
W3	WIRE, BLACK, 22 AWG ~ 2.0"	1
J1, J2	CONNECTOR, SMA, PANEL MOUNT JACK, FLANGE, 4-HOLE, BLUNT POST, 20MIL	2
J3	CONNECTOR, HEADER, RT>PLZ .1CEN LK 9POS	1
J4	CONNECTOR, SMB-U SURFACE MOUNT	1
-	PCB, TEST FIXTURE, TACONICS RF35P, 20 MILS, 440208 PKG	1
-	2-56 SOC HD SCREW 1/4 SS	4
-	#2 SPLIT LOCKWASHER SS	4
Q1	CMPA801B025F	1

CMPA801B025F-AMP Demonstration Amplifier Circuit

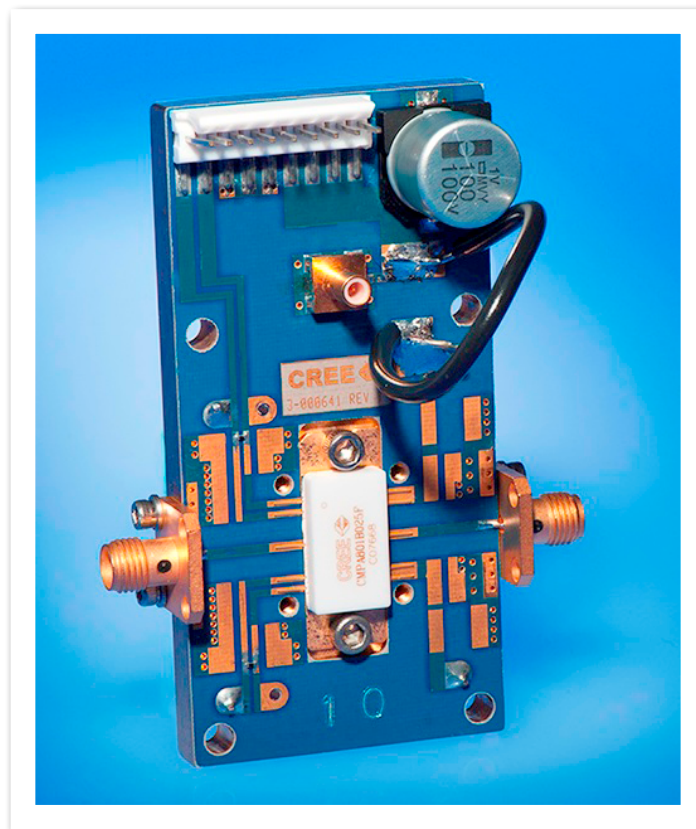

CMPA801B025F-AMP Demonstration Amplifier Circuit Schematic

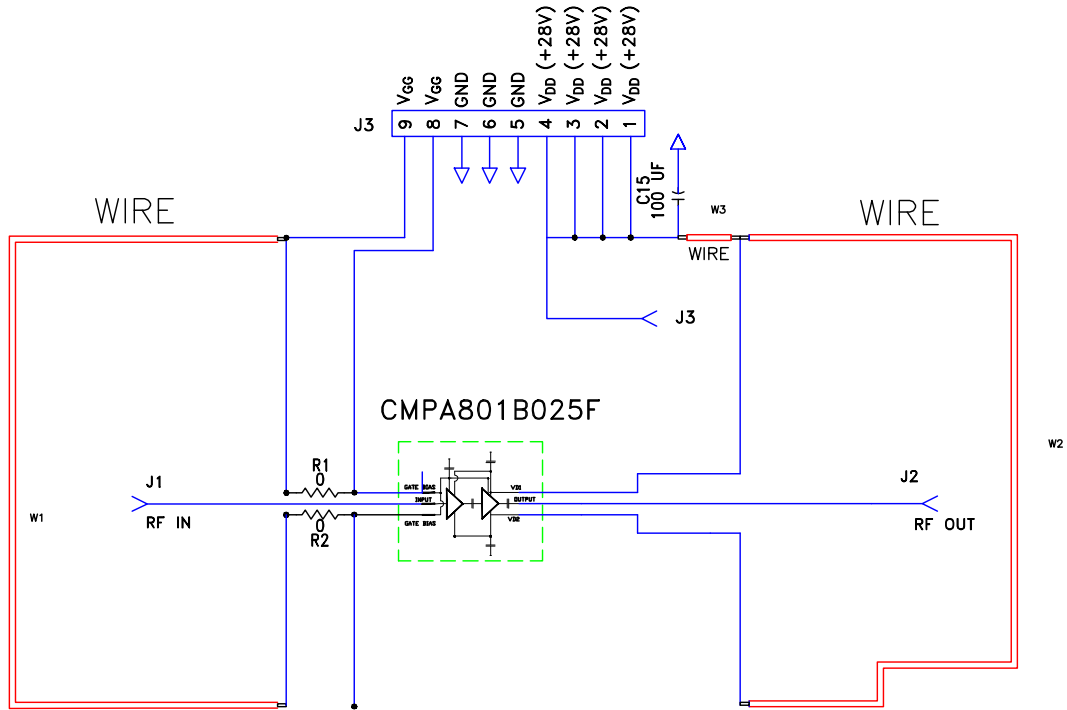

CMPA801B025F-AMP Demonstration Amplifier Circuit Outline

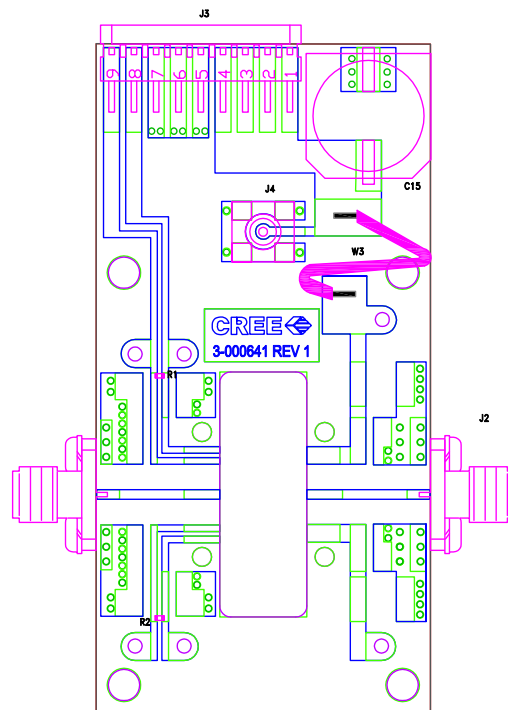

CMPA801B025F-AMP Demonstration Amplifier Circuit Schematic

To configure the CMPA801B025F test fixture to enable independent V_{G1} / V_{G2} control of the device, a cut must be made to the microstrip line just above the R1 resistor as shown. Pin 9 will then supply V_{G1} and Pin 8 will supply V_{G2} .

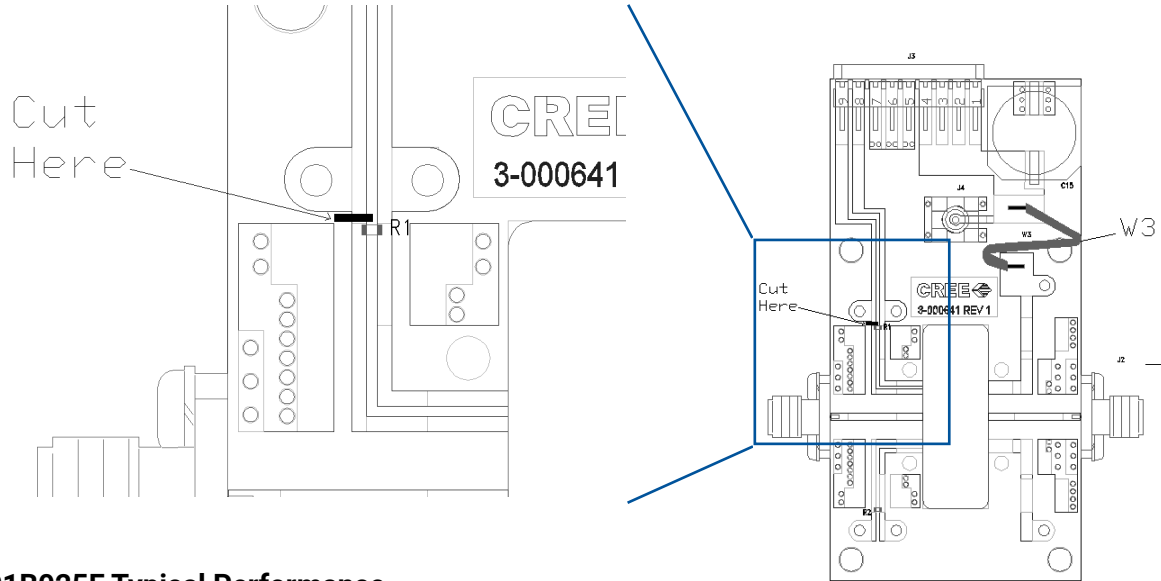

CMPA801B025F Typical Performance

Figure 7. - Transient Thermal Performance

$T_{CASE} = 85^{\circ}C$

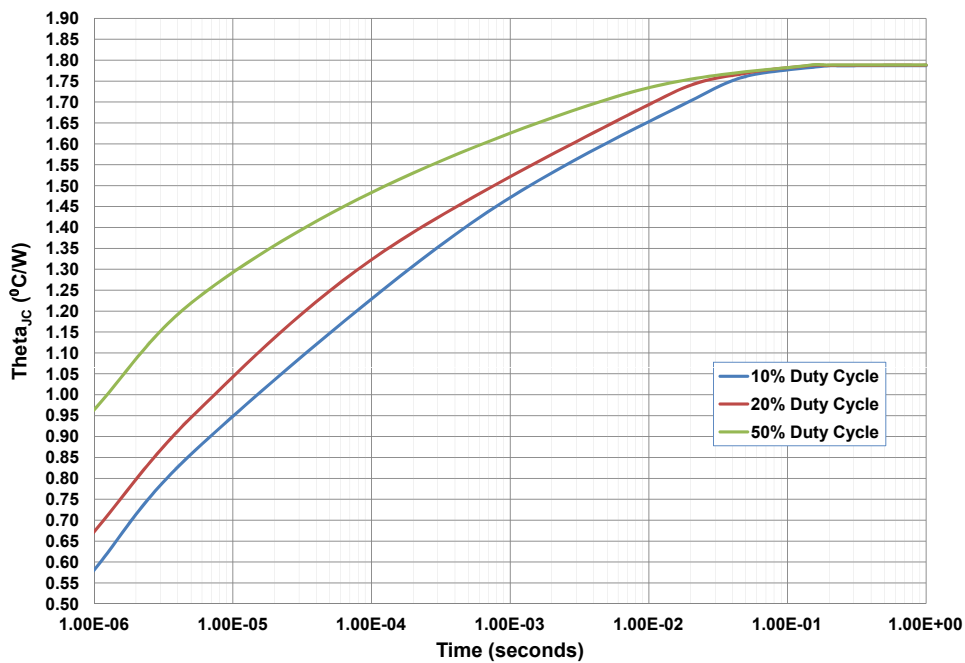

Product Dimensions CMPA801B025F (Package Type – 440208)

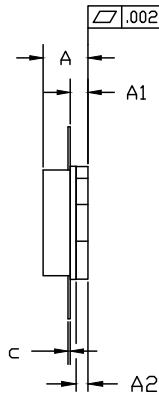
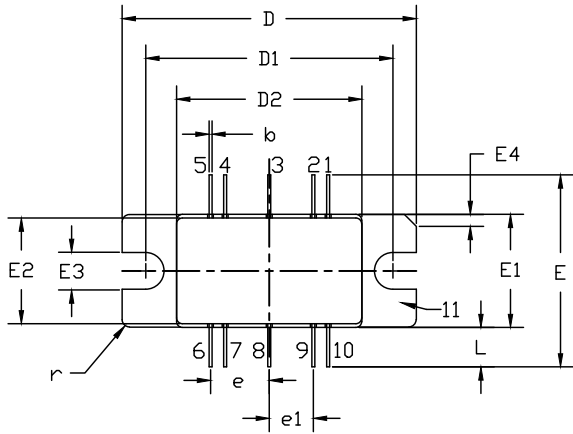

PIN 1: GATE BIAS 6: DRAIN BIAS
 2: GATE BIAS 7: DRAIN BIAS
 3: RF IN 8: RF OUT
 4: GATE BIAS 9: DRAIN BIAS
 5: GATE BIAS 10: DRAIN BIAS
 11: SOURCE

NOTES:

- DIMENSIONING AND TOLERANCING PER ANSI Y14.5M - 1994.
- CONTROLLING DIMENSION: INCH.
- ADHESIVE FROM LID MAY EXTEND A MAXIMUM OF 0.020" BEYOND EDGE OF LID.
- LID MAY BE MISALIGNED TO THE BODY OF PACKAGE BY A MAXIMUM OF 0.008" IN ANY DIRECTION.

DIM	INCHES		MILLIMETERS		NOTES
	MIN	MAX	MIN	MAX	
A	0.148	0.168	3.76	4.27	
A1	0.055	0.065	1.40	1.65	
A2	0.035	0.045	0.89	1.14	
b	0.01	TYP	0.254	TYP	10x
c	0.007	0.009	0.18	0.23	
D	0.995	1.005	25.27	25.53	
D1	0.835	0.845	21.21	21.46	
D2	0.623	0.637	15.82	16.18	
E	0.653	TYP	16.59	TYP	
E1	0.380	0.390	9.65	9.91	
E2	0.355	0.365	9.02	9.27	
E3	0.120	0.130	3.05	3.30	
E4	0.035	0.045	0.89	1.14	45° CHAMFER
e	0.200	TYP	5.08	TYP	4x
e1	0.150	TYP	3.81	TYP	4x
L	0.115	0.155	2.92	3.94	10x
r	0.025	TYP	.635	TYP	3x

Pin Number	Qty
1	Gate Bias for Stage 2
2	Gate Bias for Stage 2
3	RF In
4	Gate Bias for Stage 1
5	Gate Bias for Stage 1
6	Drain Bias
7	Drain Bias
8	RF Out
9	Drain Bias
10	Drain Bias
11	Source

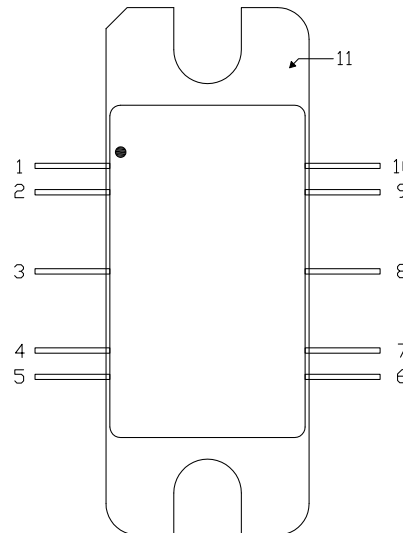

Product Dimensions CMPA801B025P (Package Type – 440216)

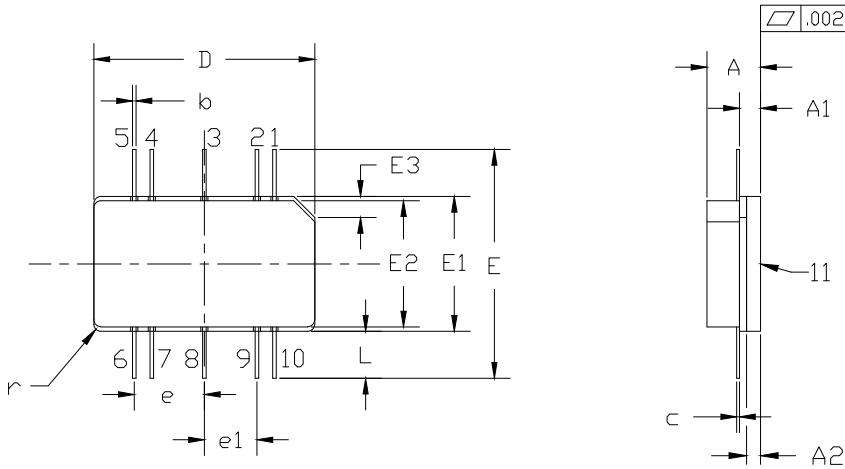

PIN 1: GATE BIAS 6: DRAIN BIAS
 2: GATE BIAS 7: DRAIN BIAS
 3: RF IN 8: RF OUT
 4: GATE BIAS 9: DRAIN BIAS
 5: GATE BIAS 10: DRAIN BIAS
 11: SOURCE

NOTES:

1. DIMENSIONING AND TOLERANCING PER ANSI Y14.5M - 1994.
2. CONTROLLING DIMENSION: INCH.
3. ADHESIVE FROM LID MAY EXTEND A MAXIMUM OF 0.020" BEYOND EDGE OF LID.
4. LID MAY BE MISALIGNED TO THE BODY OF PACKAGE BY A MAXIMUM OF 0.008" IN ANY DIRECTION.

DIM	INCHES		MILLIMETERS		NOTES
	MIN	MAX	MIN	MAX	
A	0.148	0.168	3.76	4.27	
A1	0.055	0.065	1.40	1.65	
A2	0.035	0.045	0.89	1.14	
b	0.01 TYP		0.254 TYP		10x
c	0.007	0.009	0.18	0.23	
D	0.623	0.637	15.82	16.18	
E	0.653 TYP		16.59 TYP		
E1	0.380	0.390	9.65	9.91	
E2	0.355	0.365	9.02	9.27	
E3	0.080	0.090	2.03	2.29	45° CHAMFER
e	0.200 TYP		5.08 TYP		4x
e1	0.150 TYP		3.81 TYP		4x
L	0.115	0.155	2.92	3.94	10x
r	0.020 TYP		.508 TYP		3x

Pin Number	Qty
1	Gate Bias for Stage 2
2	Gate Bias for Stage 2
3	RF In
4	Gate Bias for Stage 1
5	Gate Bias for Stage 1
6	Drain Bias
7	Drain Bias
8	RF Out
9	Drain Bias
10	Drain Bias
11	Source

Part Number System

CMPA801B025F

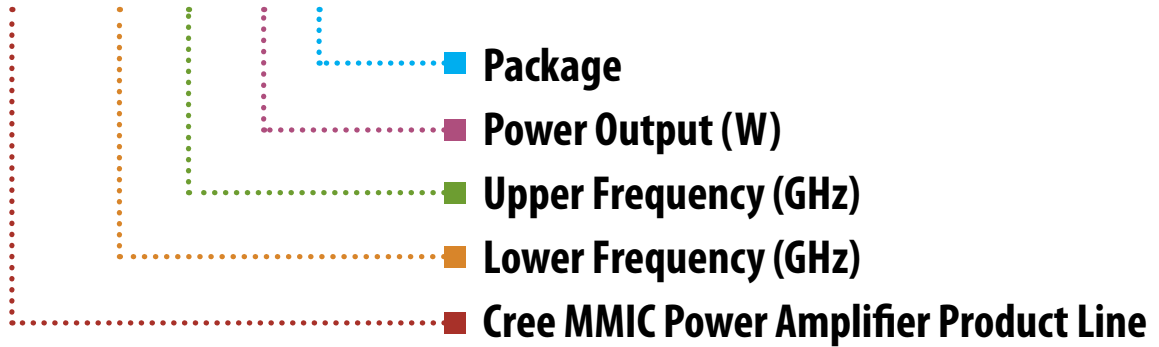

Parameter	Value	Units
Lower Frequency	8.5	GHz
Upper Frequency ¹	11.0	GHz
Power Output	25	W
Package	Flange	-

Table 1.

Note¹: Alpha characters used in frequency code indicate a value greater than 9.9 GHz. See Table 2 for value.

Character Code	Code Value
A	0
B	1
C	2
D	3
E	4
F	5
G	6
H	7
J	8
K	9
Examples:	1A = 10.0 GHz 2H = 27.0 GHz

Table 2.

Product Ordering Information

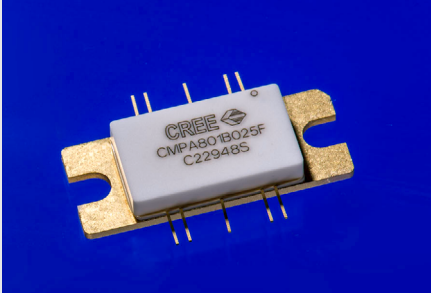
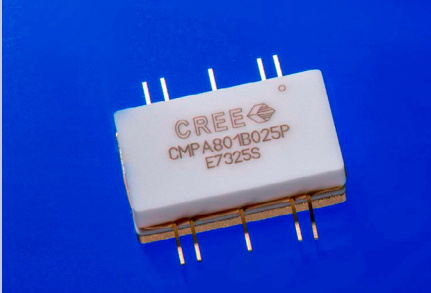
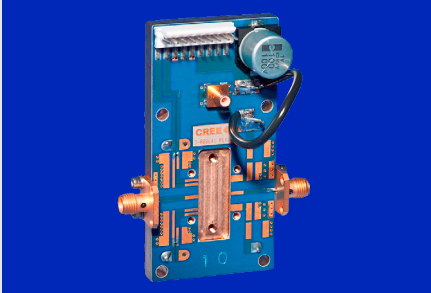
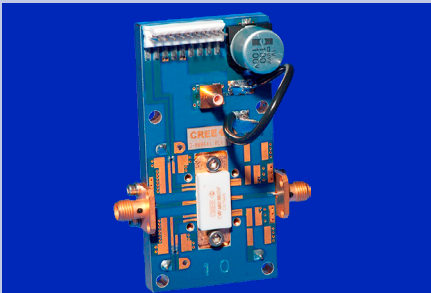
Order Number	Description	Unit of Measure	Image
CMPA801B025F	GaN HEMT	Each	
CMPA801B025P	GaN HEMT	Each	
CMPA801B025F-TB	Test board without GaN HEMT	Each	
CMPA801B025F-AMP	Test board with GaN HEMT installed	Each	



Disclaimer

Specifications are subject to change without notice. Cree, Inc. believes the information contained within this data sheet to be accurate and reliable. However, no responsibility is assumed by Cree for its use or for any infringement of patents or other rights of third parties which may result from its use. No license is granted by implication or otherwise under any patent or patent rights of Cree. Cree makes no warranty, representation or guarantee regarding the suitability of its products for any particular purpose. "Typical" parameters are the average values expected by Cree in large quantities and are provided for information purposes only. These values can and do vary in different applications, and actual performance can vary over time. All operating parameters should be validated by customer's technical experts for each application. Cree products are not designed, intended, or authorized for use as components in applications intended for surgical implant into the body or to support or sustain life, in applications in which the failure of the Cree product could result in personal injury or death, or in applications for the planning, construction, maintenance or direct operation of a nuclear facility. CREE and the CREE logo are registered trademarks of Cree, Inc.

For more information, please contact:

Cree, Inc.
4600 Silicon Drive
Durham, North Carolina, USA 27703
www.cree.com/RF

Sarah Miller
Marketing
Cree, RF Components
1.919.407.5302

Ryan Baker
Marketing & Sales
Cree, RF Components
1.919.407.7816

Tom Dekker
Sales Director
Cree, RF Components
1.919.407.5639