



BGU8061

low-noise high-linearity amplifier

Rev. 2 — 27 January 2017

Product data sheet

1 General description

The BGU8061 is, also known as the BTS3001L, a high-linearity bypass amplifier for wireless infrastructure applications, equipped with fast shutdown to support TDD systems. The LNA has a high input and output return loss and is designed to operate between 0.7 GHz and 1.5 GHz. It is housed in a 3 mm × 3 mm × 0.85 mm 10-terminal plastic thin small outline package. The LNA is ESD protected on all terminals.

2 Features and benefits

- Low-noise performance: NF = 1.1 dB
- High-linearity performance: IP_{3O} = 36.5 dBm
- High-input return loss > 10 dB
- High-output return loss > 10 dB
- Unconditionally stable up to 20 GHz
- Small 10-terminal leadless package 3 mm × 3 mm × 0.85 mm
- ESD protection on all terminals
- Moisture sensitivity level 1
- Fast shut down to support TDD systems
- +5 V single supply

3 Applications

- Wireless infrastructure
- Low noise and high-linearity applications
- LTE, W-CDMA, CDMA, GSM
- General-purpose wireless applications
- TDD or FDD systems
- Suitable for small cells



4 Quick reference data

Table 1. Quick reference data

$f = 900\text{ MHz}$; $V_{CC} = 5\text{ V}$; $T_{amb} = 25\text{ }^\circ\text{C}$; input and output $50\ \Omega$; unless otherwise specified. All RF parameters are measured on an application board with the circuit as shown in [Figure 29](#) and components listed in [Table 9](#) implemented. This board is optimized for $f = 900\text{ MHz}$.

Symbol	Parameter	Conditions	Min	Typ	Max	Unit
I _{CC}	supply current	LNA enable; bypass off	-	70	85	mA
		LNA disable; bypass on	-	3	5	mA
G _{ass}	associated gain	LNA enable; bypass off	19	20.5	22	dB
		LNA disable; bypass on	-1.6	-1.0	-	dB
NF	noise figure	LNA enable; bypass off ^[1]	-	1.1	1.8	dB
P _{L(1dB)}	output power at 1 dB gain compression	LNA enable; bypass off	19	20.5	-	dBm
IP _{3O}	output third-order intercept point	2-tone; tone spacing = 1 MHz; PL = 5 dBm per tone				
		LNA enable; bypass off	33.5	36.5	-	dBm
		LNA disable; bypass on	-	44	-	dBm

[1] Connector and Printed-Circuit Board (PCB) losses have been de-embedded.

5 Ordering information

Table 2. Ordering information

Type number	Package		Version
	Name	Description	
BGU8061	HVSON10	plastic thermal enhanced very thin small outline package; no leads; 10 terminals; body 3 mm × 3 mm × 0.85 mm	SOT650-2

6 Block diagram

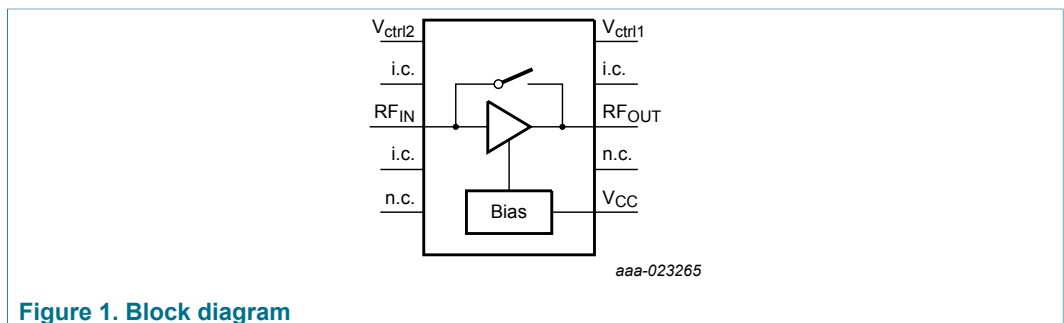
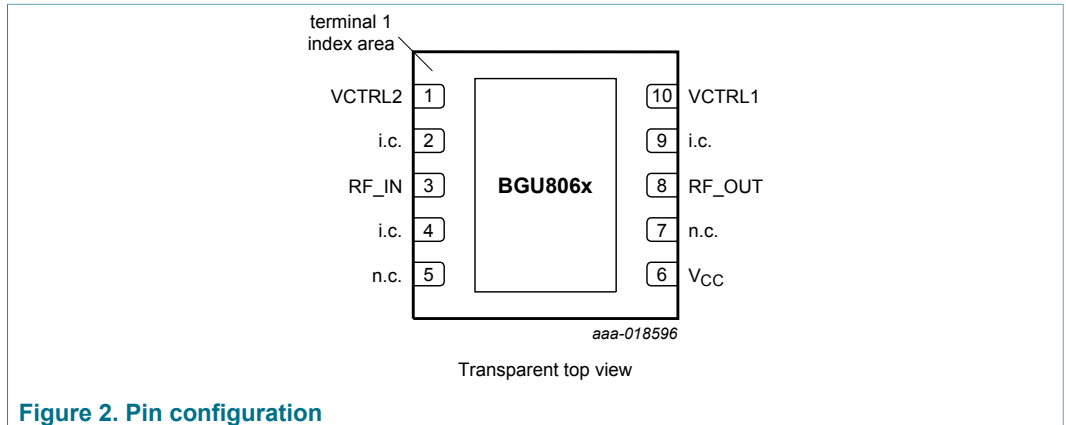

Figure 1. Block diagram

7 Pinning information

7.1 Pinning



7.2 Pin description

Table 3. Pin description

Symbol	Pin	Description
VCTRL2	1	voltage control 2
i.c.	2, 4, 9	internally connected, can be grounded or left open in the application
RF_IN	3	RF input
n.c.	5	not connected
V _{CC}	6	supply voltage
n.c.	7	not connected
RF_OUT	8	RF output
VCTRL1	10	voltage control 1
GND	exposed die pad	ground

8 Limiting values

Table 4. Limiting values

In accordance with the Absolute Maximum Rating System (IEC 60134).

Symbol	Parameter	Conditions	Min	Max	Unit
V _{CC}	supply voltage		-	6	V
V _{i(CTRL1)}	input voltage on pin CTRL1		-	3.6	V
V _{i(CTRL2)}	input voltage on pin CTRL2		-	3.6	V
P _{I(RF)CW}	continuous waveform RF input power		-	20	dBm
T _{amb}	ambient temperature		-40	+85	°C
T _{stg}	storage temperature		-40	+150	°C
T _j	junction temperature		-	150	°C
P	power dissipation	T _{case} ≤ 125 °C [1]	-	510	mW
V _{ESD}	electrostatic discharge voltage	Human Body Model (HBM) according to ANSI/ESDA/JEDEC standard JS-001-2010	-	2.0	kV
		Charged Device Model (CDM) according to JEDEC standard 22-C101B	-	1.0	kV

[1] Case is ground solder pad.

9 Recommended operating conditions

Table 5. Characteristics

Symbol	Parameter	Conditions	Min	Typ	Max	Unit
V _{CC}	supply voltage		4.75	5	5.25	V
Z ₀	characteristic impedance		-	50	-	Ω

10 Thermal characteristics

Table 6. Thermal characteristics

Symbol	Parameter	Conditions	Min	Typ	Max	Unit
R _{th(j-case)}	thermal resistance from junction to case	[1] [2]	-	55	-	K/W

[1] Case is ground solder pad.

[2] Thermal resistance measured using infrared measurement technique, device mounted on application board and placed in still air.

11 Characteristics

Table 7. Characteristics

$f = 900\text{ MHz}$; $V_{CC} = 5\text{ V}$; $T_{amb} = 25\text{ °C}$; input and output $50\ \Omega$; unless otherwise specified. All RF parameters are measured on an application board with the circuit as shown in [Figure 29](#) and components listed in [Table 9](#) implemented. This board is optimized for $f = 900\text{ MHz}$.

Symbol	Parameter	Conditions	Min	Typ	Max	Unit
I_{CC}	supply current	LNA enable; bypass off	-	70	85	mA
		LNA disable; bypass on	-	3	5	mA
G_{ass}	associated gain	LNA enable; bypass off	19	20.5	22	dB
		LNA disable; bypass on	-1.6	-1.0	-	dB
G_{flat}	gain flatness	within 100 MHz bandwidth; LNA enable; bypass off				
		$700\text{ MHz} \leq f \leq 1500\text{ MHz}$	-	0.9	-	dB
		$1000\text{ MHz} \leq f \leq 1500\text{ MHz}$	-	0.8	-	dB
NF	noise figure	LNA enable; bypass off ^[1]	-	1.1	1.8	dB
ΔG	gain variation	$700\text{ MHz} \leq f \leq 1500\text{ MHz}$	-	5.5	-	dB
$P_{L(1dB)}$	output power at 1 dB gain compression	LNA enable; bypass off	19	20.5	-	dBm
$IP3_O$	output third-order intercept point	2-tone; tone spacing = 1 MHz; $P_L = 5\text{ dBm}$ per tone				
		LNA enable; bypass off	33.5	36.5	-	dBm
		LNA disable; bypass on	-	44	-	dBm
RL_{in}	input return loss	LNA enable; bypass off	-	10	-	dB
		LNA disable; bypass on	-	15	-	dB
RL_{out}	output return loss	LNA enable; bypass off	-	10	-	dB
		LNA disable; bypass on	-	15	-	dB
ISL	isolation	LNA disable; bypass off	-	30	-	dB
		LNA enable; bypass off	-	20	-	dB
$t_{s(pon)}$	power-on settling time	$P_i = -20\text{ dBm}$	-	0.5	-	μs
$t_{s(poff)}$	power-off settling time	$P_i = -20\text{ dBm}$	-	0.1	-	μs
K	Rollett stability factor	both on-state and off-state up to $f = 20\text{ GHz}$	1	-	-	-

[1] Connector and Printed-Circuit Board (PCB) losses have been de-embedded.

Table 8. Control truth table

 $V_{CC} = 5\text{ V}$; $T_{amb} = 25\text{ }^{\circ}\text{C}$.

Control signal setting ^[1]		Mode of operation	
CTRL2 (pin 1)	CTRL1 (pin 10)	LNA	bypass
HIGH	LOW	disable	on
HIGH	HIGH	disable	on
LOW	LOW	enable	off
LOW	HIGH	disable	off

[1] A logic LOW is the result of an input voltage on that specific pin between -0.3 V and $+0.7\text{ V}$.
A logic HIGH is the result of an input voltage on that specific pin between 1.2 V and 3.6 V .

12 Graphics

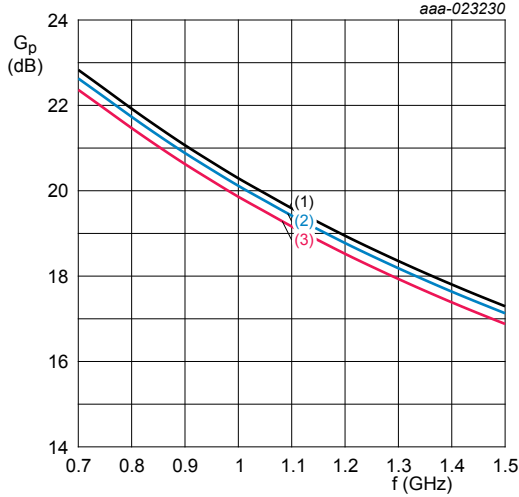

$V_{CC} = 5\text{ V}$
 (1) $T_{amb} = -40\text{ °C}$
 (2) $T_{amb} = +25\text{ °C}$
 (3) $T_{amb} = +95\text{ °C}$

Figure 3. Power gain as a function of frequency
 Gain mode; typical values

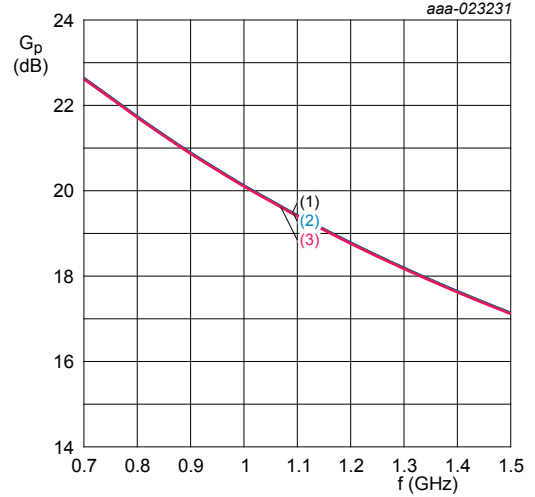

$T_{amb} = +25\text{ °C}$
 (1) $V_{CC} = 4.75\text{ V}$
 (2) $V_{CC} = 5\text{ V}$
 (3) $V_{CC} = 5.25\text{ V}$

Figure 4. Power gain as a function of frequency
 Gain mode; typical values

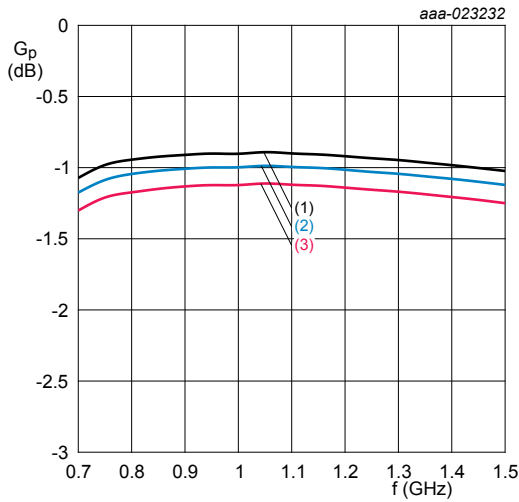

$V_{CC} = 5\text{ V}$
 (1) $T_{amb} = -40\text{ °C}$
 (2) $T_{amb} = +25\text{ °C}$
 (3) $T_{amb} = +95\text{ °C}$

Figure 5. Power gain as a function of frequency
 Bypass mode; typical values

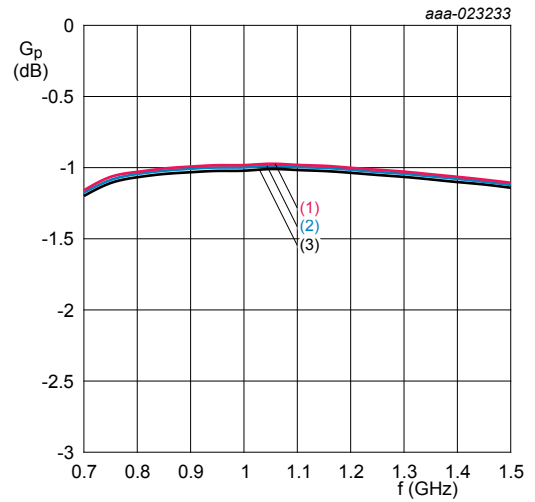

$T_{amb} = +25\text{ °C}$
 (1) $V_{CC} = 4.75\text{ V}$
 (2) $V_{CC} = 5\text{ V}$
 (3) $V_{CC} = 5.25\text{ V}$

Figure 6. Power gain as a function of frequency
 Bypass mode; typical values

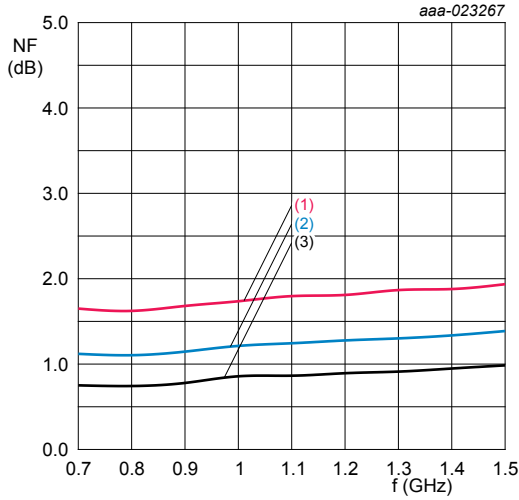

$V_{CC} = 5\text{ V}$
 (1) $T_{amb} = -40\text{ °C}$
 (2) $T_{amb} = +25\text{ °C}$
 (3) $T_{amb} = +95\text{ °C}$

Figure 7. Noise figure as a function of frequency
 Gain mode; typical values

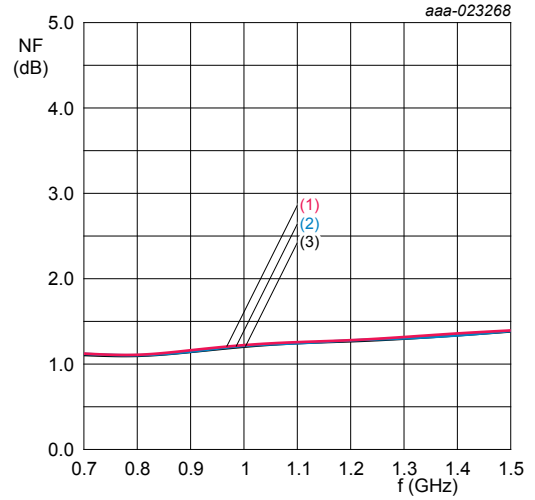

$T_{amb} = +25\text{ °C}$
 (1) $V_{CC} = 4.75\text{ V}$
 (2) $V_{CC} = 5\text{ V}$
 (3) $V_{CC} = 5.25\text{ V}$

Figure 8. Noise figure as a function of frequency
 Gain mode; typical values

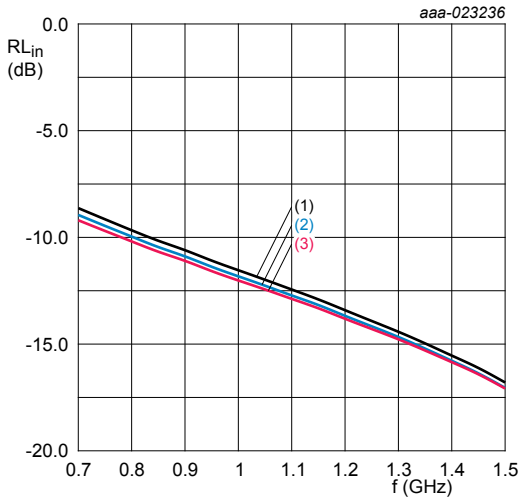

$V_{CC} = 5\text{ V}$
 (1) $T_{amb} = -40\text{ °C}$
 (2) $T_{amb} = +25\text{ °C}$
 (3) $T_{amb} = +95\text{ °C}$

Figure 9. Input return loss as a function of frequency
 Gain mode; typical values

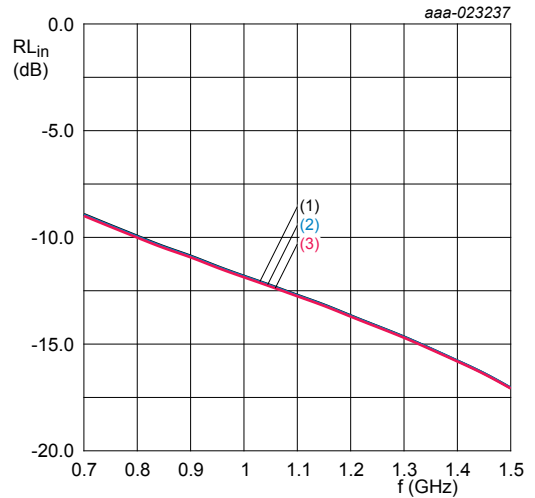

$T_{amb} = +25\text{ °C}$
 (1) $V_{CC} = 4.75\text{ V}$
 (2) $V_{CC} = 5\text{ V}$
 (3) $V_{CC} = 5.25\text{ V}$

Figure 10. Input return loss as a function of frequency
 Gain mode; typical values

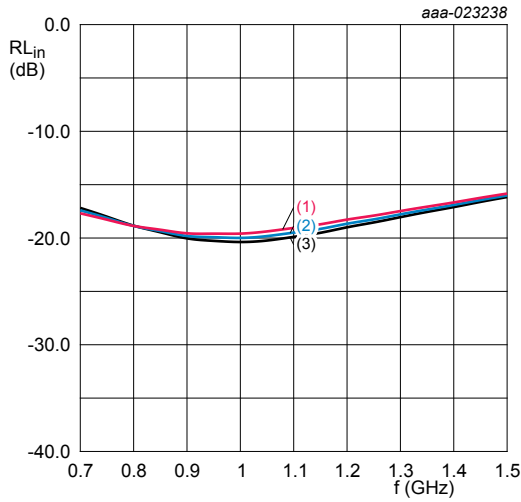

$V_{CC} = 5\text{ V}$
 (1) $T_{amb} = -40\text{ °C}$
 (2) $T_{amb} = +25\text{ °C}$
 (3) $T_{amb} = +95\text{ °C}$

Figure 11. Input return loss as a function of frequency
 Bypass mode; typical values

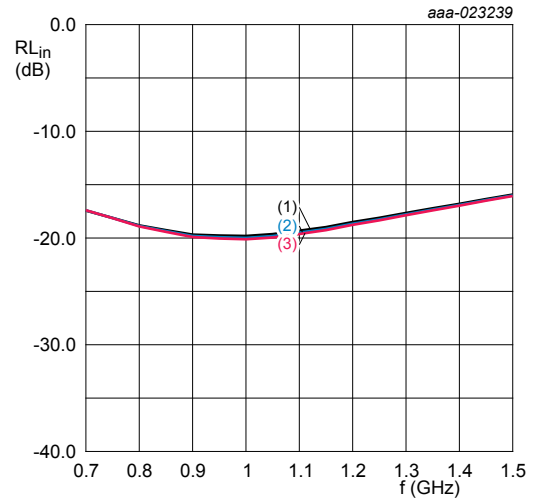

$T_{amb} = +25\text{ °C}$
 (1) $V_{CC} = 4.75\text{ V}$
 (2) $V_{CC} = 5\text{ V}$
 (3) $V_{CC} = 5.25\text{ V}$

Figure 12. Input return loss as a function of frequency
 Bypass mode; typical values

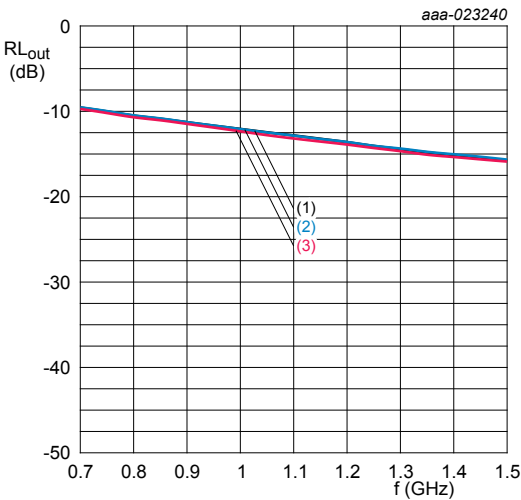

$V_{CC} = 5\text{ V}$
 (1) $T_{amb} = -40\text{ °C}$
 (2) $T_{amb} = +25\text{ °C}$
 (3) $T_{amb} = +95\text{ °C}$

Figure 13. Output return loss as a function of frequency
 Gain mode; typical values

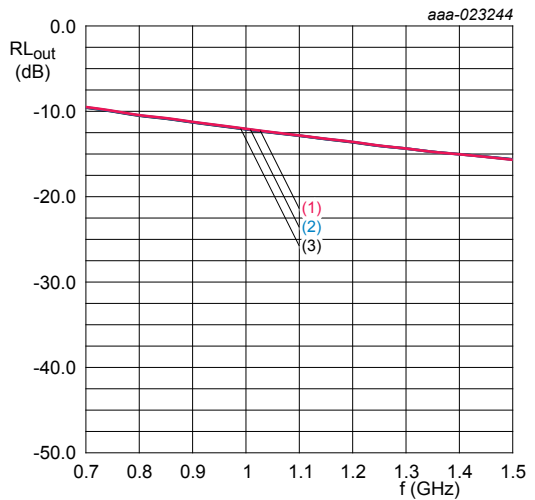

$T_{amb} = +25\text{ °C}$
 (1) $V_{CC} = 4.75\text{ V}$
 (2) $V_{CC} = 5\text{ V}$
 (3) $V_{CC} = 5.25\text{ V}$

Figure 14. Output return loss as a function of frequency
 Gain mode; typical values

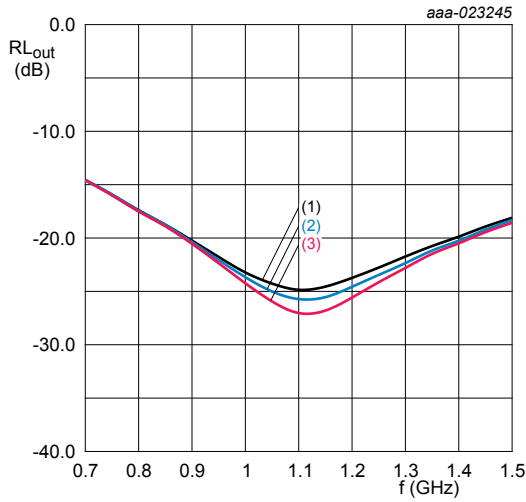

$V_{CC} = 5\text{ V}$
 (1) $T_{amb} = -40\text{ °C}$
 (2) $T_{amb} = +25\text{ °C}$
 (3) $T_{amb} = +95\text{ °C}$

Figure 15. Output return loss as a function of frequency Bypass mode; typical values

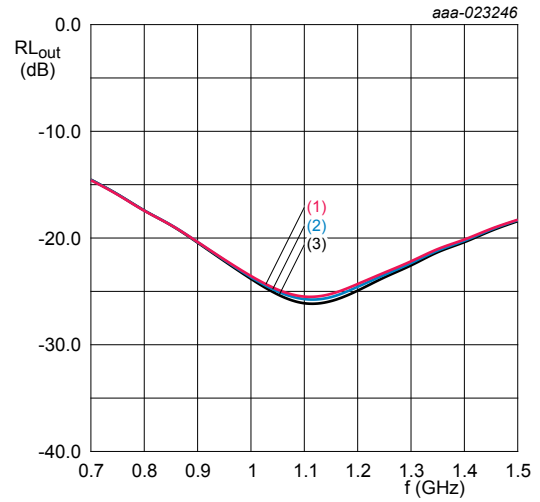

$T_{amb} = +25\text{ °C}$
 (1) $V_{CC} = 4.75\text{ V}$
 (2) $V_{CC} = 5\text{ V}$
 (3) $V_{CC} = 5.25\text{ V}$

Figure 16. Output return loss as a function of frequency Bypass mode; typical values

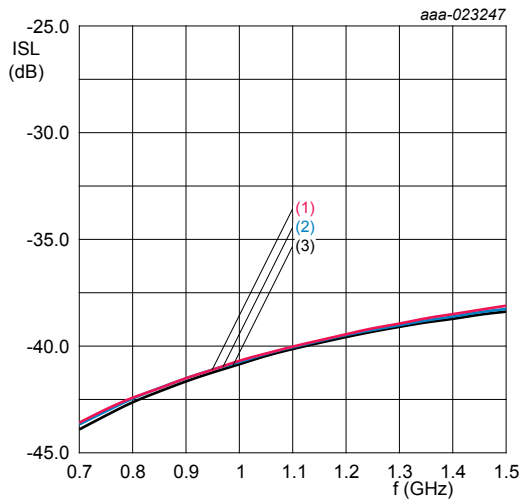

$V_{CC} = 5\text{ V}$
 (1) $T_{amb} = -40\text{ °C}$
 (2) $T_{amb} = +25\text{ °C}$
 (3) $T_{amb} = +95\text{ °C}$

Figure 17. Isolation as a function of frequency Isolation mode; typical values

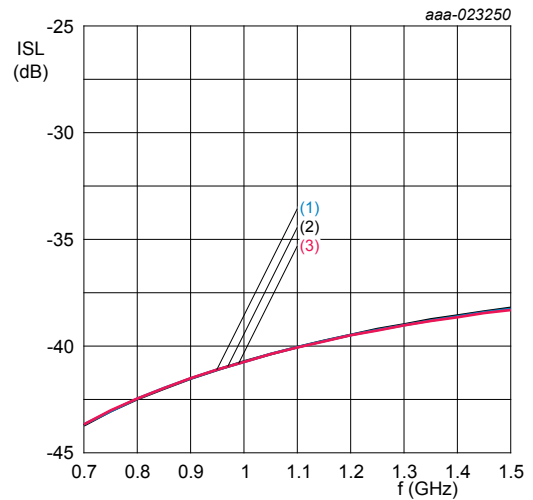

$T_{amb} = +25\text{ °C}$
 (1) $V_{CC} = 4.75\text{ V}$
 (2) $V_{CC} = 5\text{ V}$
 (3) $V_{CC} = 5.25\text{ V}$

Figure 18. Isolation as a function of frequency Isolation mode; typical values

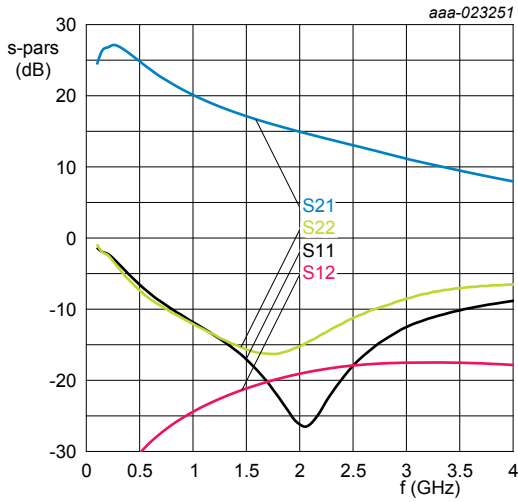

$V_{CC} = 5\text{ V}; T_{amb} = +25\text{ }^{\circ}\text{C}$

Figure 19. Wideband S-parameters as function of frequency Gain mode; typical values

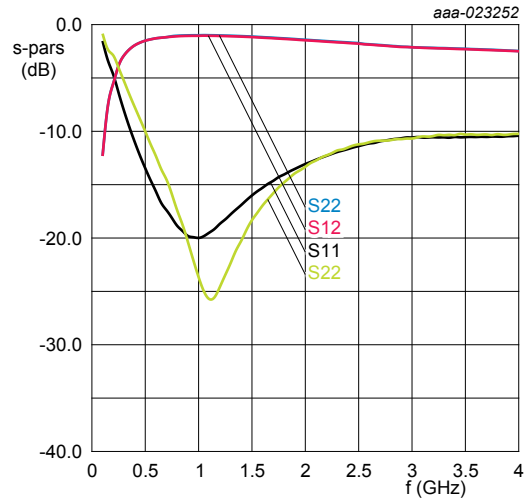

$V_{CC} = 5\text{ V}; T_{amb} = +25\text{ }^{\circ}\text{C}$

Figure 20. Wideband S-parameters as function of frequency Bypass mode; typical values

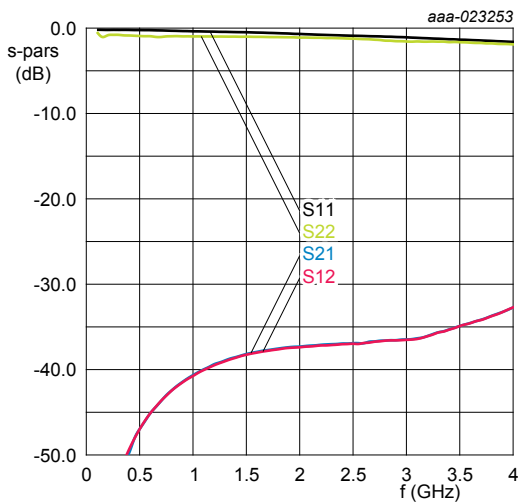

$V_{CC} = 5\text{ V}; T_{amb} = +25\text{ }^{\circ}\text{C}$

Figure 21. Wideband S-parameters as function of frequency Isolation mode; typical values

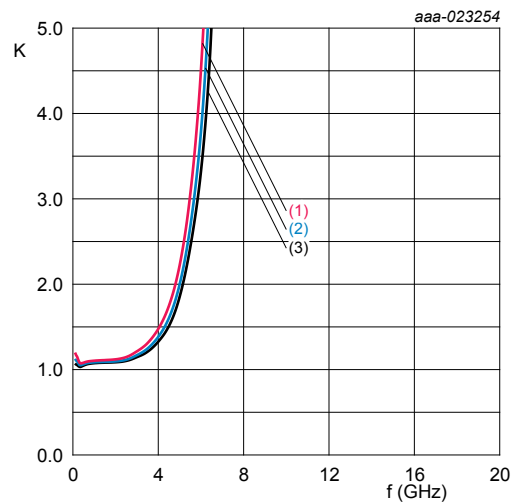

$V_{CC} = 5\text{ V}$
 (1) $T_{amb} = -40\text{ }^{\circ}\text{C}$
 (2) $T_{amb} = +25\text{ }^{\circ}\text{C}$
 (3) $T_{amb} = +95\text{ }^{\circ}\text{C}$

Figure 22. Rollett Stability factor as function of frequency Gain mode; typical values

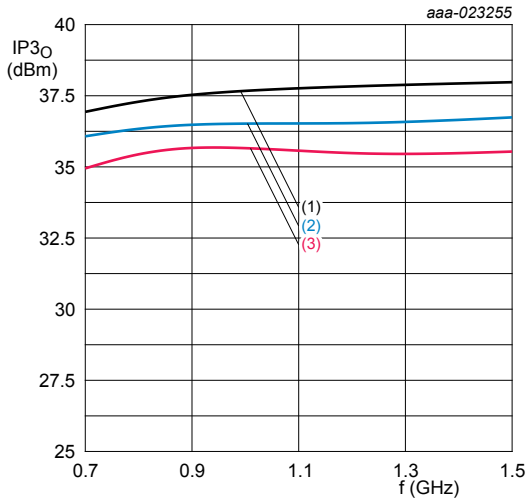

$V_{CC} = 5\text{ V}$
 (1) $T_{amb} = -40\text{ °C}$
 (2) $T_{amb} = +25\text{ °C}$
 (3) $T_{amb} = +95\text{ °C}$

Figure 23. Output third-order intercept point as a function of frequency Gain mode; typical values

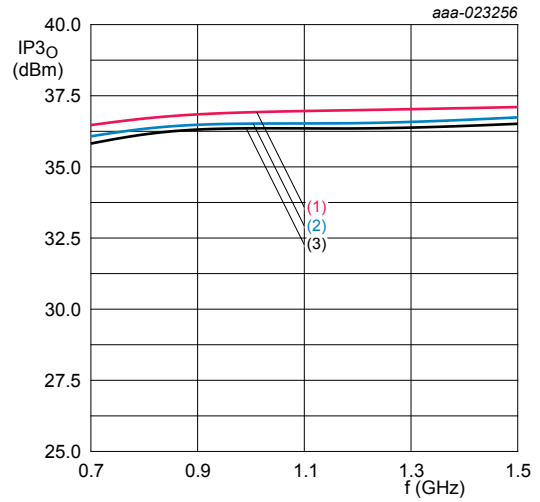

$T_{amb} = +25\text{ °C}$
 (1) $V_{CC} = 4.75\text{ V}$
 (2) $V_{CC} = 5\text{ V}$
 (3) $V_{CC} = 5.25\text{ V}$

Figure 24. Output third-order intercept point as a function of frequency Gain mode; typical values

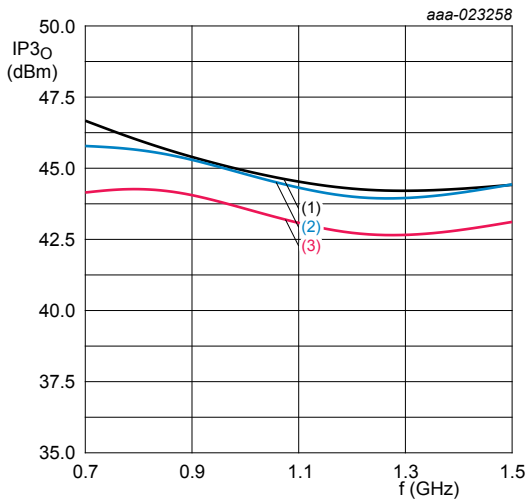

$V_{CC} = 5\text{ V}$
 (1) $T_{amb} = -40\text{ °C}$
 (2) $T_{amb} = +25\text{ °C}$
 (3) $T_{amb} = +95\text{ °C}$

Figure 25. Output third-order intercept point as a function of frequency Bypass mode; typical values

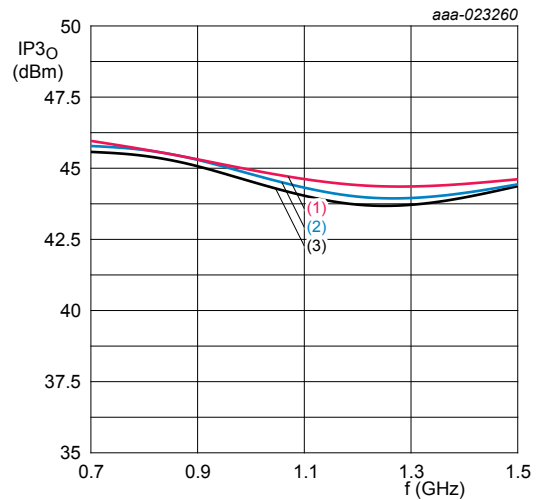

$T_{amb} = +25\text{ °C}$
 (1) $V_{CC} = 4.75\text{ V}$
 (2) $V_{CC} = 5\text{ V}$
 (3) $V_{CC} = 5.25\text{ V}$

Figure 26. Output third-order intercept point as a function of frequency Bypass mode; typical values

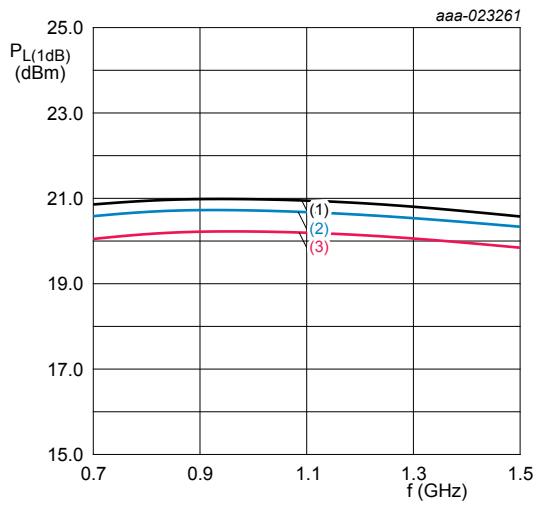

$V_{CC} = 5\text{ V}$

(1) $T_{amb} = -40\text{ }^{\circ}\text{C}$

(2) $T_{amb} = +25\text{ }^{\circ}\text{C}$

(3) $T_{amb} = +95\text{ }^{\circ}\text{C}$

Figure 27. Output power at 1 dB gain compression as a function of frequency Gain mode; typical values

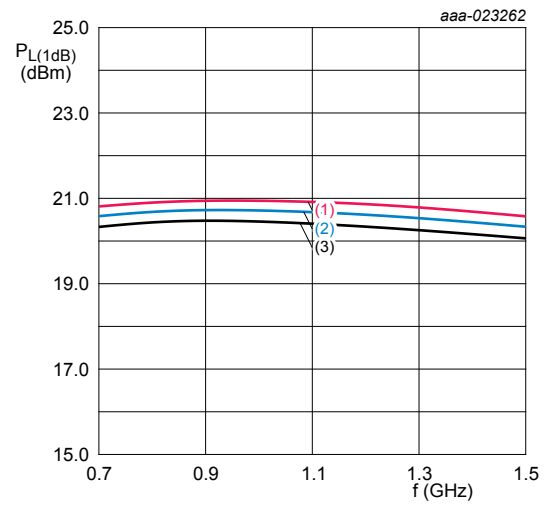

$T_{amb} = +25\text{ }^{\circ}\text{C}$

(1) $V_{CC} = 4.75\text{ V}$

(2) $V_{CC} = 5\text{ V}$

(3) $V_{CC} = 5.25\text{ V}$

Figure 28. Output power at 1 dB gain compression as a function of frequency Gain mode; typical values

13 Application information

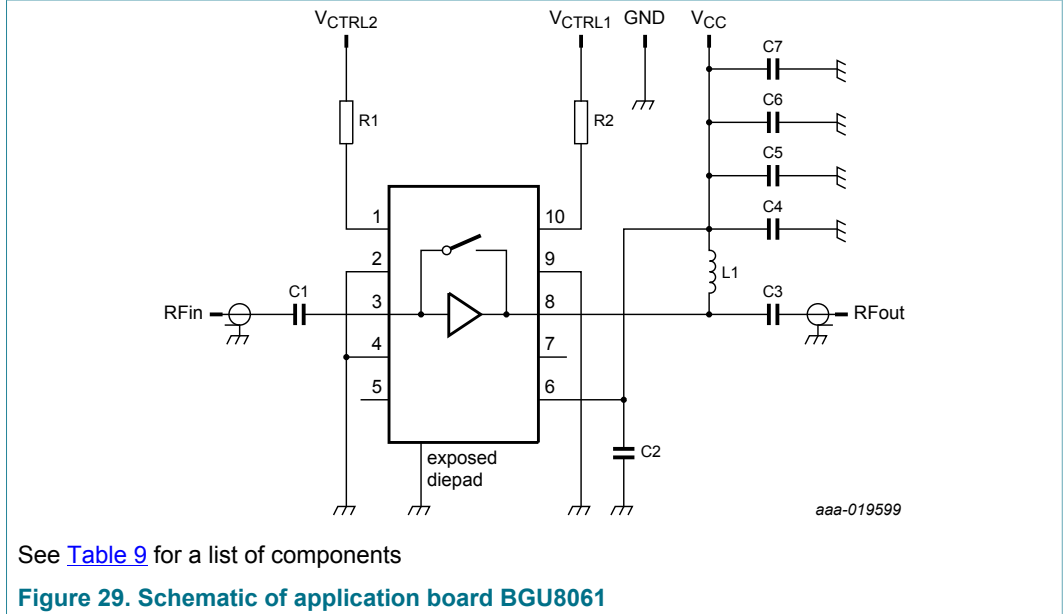

See [Table 9](#) for a list of components

Figure 29. Schematic of application board BGU8061

Table 9. List of components

See [Figure 29](#) for schematics.

Component	Description	Value	Remarks
C1	capacitor	100 nF	
C2, C3	capacitor	100 pF	
C4	capacitor	1 nF	
C5	capacitor	-	optional
C6	capacitor	10 nF	
C7	capacitor	1 μF	
L1	inductor	15 nH	
R1, R2	resistor	1 kΩ	

14 Package outline

HVSON10: plastic thermal enhanced very thin small outline package; no leads; 10 terminals; 3 x 3 x 0.85 mm SOT650-2

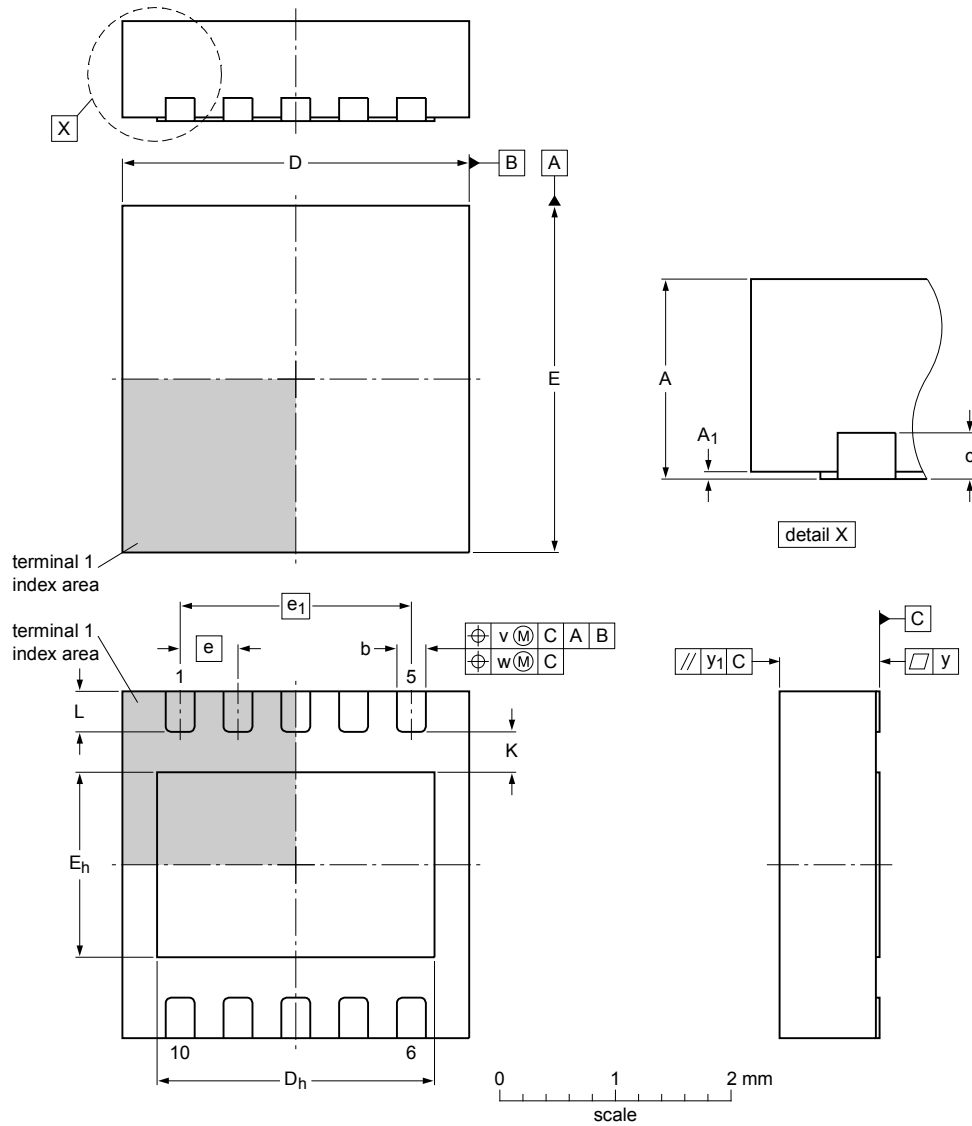

Dimensions

Unit	A ⁽¹⁾	A ₁	b	c	D ⁽¹⁾	D _h	E ⁽¹⁾	E _h	e	e ₁	K	L	v	w	y	y ₁
max	1.00	0.05	0.30		3.1	2.5	3.1	1.7			0.41	0.45				
nom	0.85	0.03	0.25	0.2	3.0	2.4	3.0	1.6	0.5	2	0.35	0.35	0.1	0.05	0.08	0.1
min	0.80	0.00	0.18		2.9	2.3	2.9	1.5			0.28	0.30				

Note

1. Plastic or metal protrusions of 0.075 mm maximum per side are not included.

sot650-2_po

Outline version	References			European projection	Issue date
	IEC	JEDEC	JEITA		
SOT650-2	---	MO-229	---		09-03-16 09-03-18

Figure 30. Package Outline SOT650-2 (HVSON10)

15 Abbreviations

Table 10. Abbreviations

Acronym	Description
CDMA	Code Division Multiple Access
ESD	ElectroStatic Discharge
FDD	Frequency-Division Duplexing
GSM	Global System for Mobile communication
LNA	Low Noise Amplifier
LTE	Long Term Evolution
TDD	Time-Division Duplexing
W-CDMA	Wideband Code Division Multiple Access

16 Revision history

Table 11. Revision history

Document ID	Release date	Data sheet status	Change notice	Supersedes
BGU8061 v.2	20170127	product data sheet	-	BGU8061 v.1
Modifications	<ul style="list-style-type: none"> • Section 1: added BTS3001L according to our new naming convention 			
BGU8061 v.1	<td>	product data sheet	-	-

Contents

1	General description	1
2	Features and benefits	1
3	Applications	1
4	Quick reference data	2
5	Ordering information	2
6	Block diagram	2
7	Pinning information	3
7.1	Pinning	3
7.2	Pin description	3
8	Limiting values	4
9	Recommended operating conditions	4
10	Thermal characteristics	4
11	Characteristics	5
12	Graphics	7
13	Application information	14
14	Package outline	15
15	Abbreviations	16
16	Revision history	16

Please be aware that important notices concerning this document and the product(s) described herein, have been included in section 'Legal information'.

© NXP Semiconductors N.V. 2017.

All rights reserved.

For more information, please visit: <http://www.nxp.com>

For sales office addresses, please send an email to: salesaddresses@nxp.com

Date of release: 27 January 2017

Document identifier: BGU8061