

## CotoMOS® CT248 / CS248 / CT348 / CS348

The CT248 / CS248 / CT348 / CS348 features current switching capability to 350mA with a low on resistance of 3.5Ω Maximum. Designed for Security, Industrial Controls, Measurement and Instrumentation applications the CotoMOS® relay is capable of handling 100V load conditions. If your requirements are different please contact your Coto Applications Engineer for assistance through [www.cotorelay.com](http://www.cotorelay.com).

### CT248/CS248 / CT348 / CS348 Features

- ▶ Contact Form: 1A/2A
- ▶ Load Voltage: 100V Maximum
- ▶ Operation LED Current: 3.0mA Maximum
- ▶ Load Current: 350mA Maximum
- ▶ On-Resistance: 3.5Ω Maximum
- ▶ Output Capacitance: 37pF Typical
- ▶ Low Off-State Leakage Current: 1.0μ A Maximum
- ▶ Suffix - H for DIP/SMD I/O Breakdown Voltage: 5000Vrms Minimum

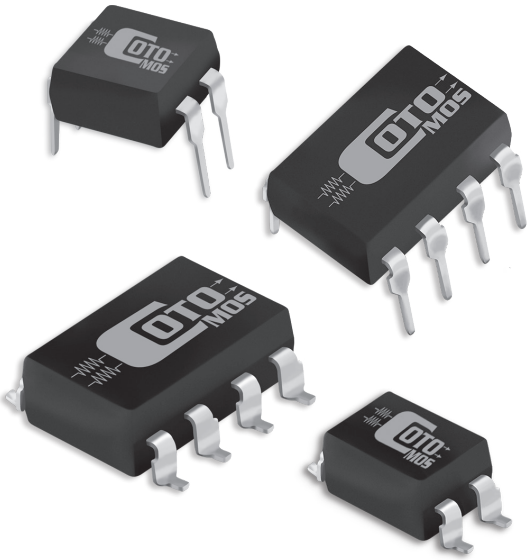

## DIMENSIONS

*in Inches (Millimeters)*

CT248

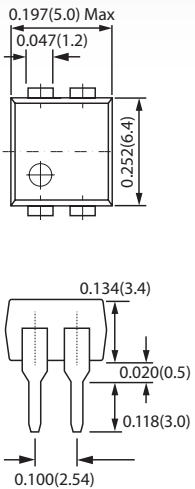

CS248

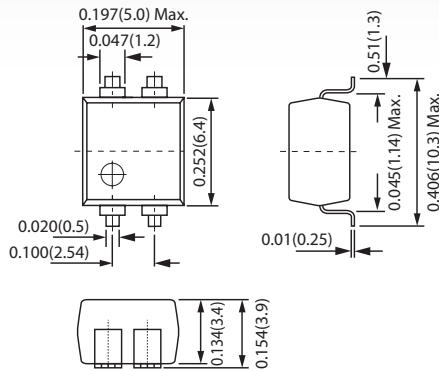

CS348

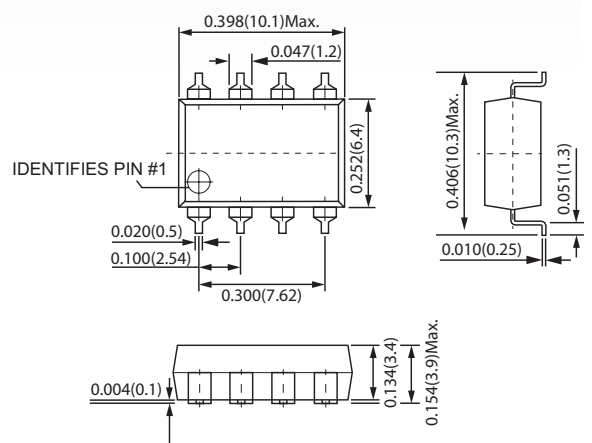

CT348

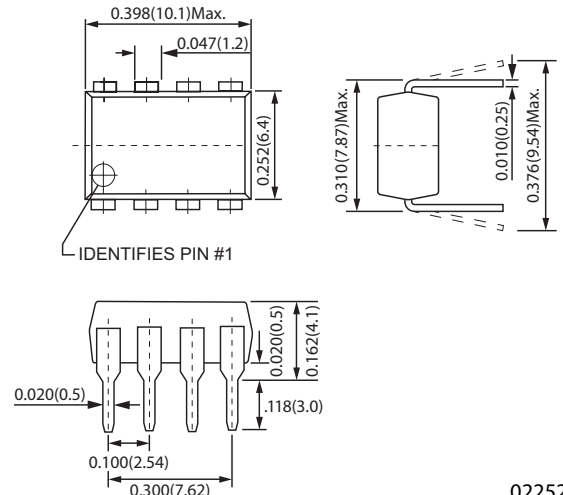

### TERMINAL IDENTIFICATION

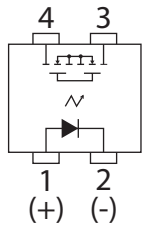

1: Anode (LED)  
2: Cathode (LED)  
3,4: Drain (MOSFET)

### TERMINAL IDENTIFICATION

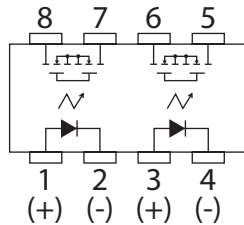

1,3: Anode (LED)  
2,4: Cathode (LED)  
5,6,7,8: Drain (MOSFET)

## CT248 / CS248 / CT348 / CS348 MAXIMUM RATINGS (Ambient Temperature: 25°C)

| Parameters                   | Symbol            | Units             | Value (DIP or SMD 4/8) |
|------------------------------|-------------------|-------------------|------------------------|
| <b>INPUT SPECIFICATIONS</b>  |                   |                   |                        |
| Continuous LED Current       | I <sub>F</sub>    | mA                | 50                     |
| Peak LED Current             | I <sub>FP</sub>   | mA                | 500                    |
| LED Reverse Voltage          | V <sub>R</sub>    | V                 | 5                      |
| Input Power Dissipation      | P <sub>in</sub>   | mW                | 75                     |
| <b>OUTPUT SPECIFICATIONS</b> |                   |                   |                        |
| Load Voltage                 | V <sub>L</sub>    | V (AC peak or DC) | 100                    |
| Load Current                 | I <sub>L</sub>    | mA                | 350 / 310              |
| Peak Load Current            | I <sub>Peak</sub> | A                 | 1400 / 1400            |
| Output Power Dissipation     | P <sub>Out</sub>  | mW                | 200 / 400              |
| <b>RELAY SPECIFICATIONS</b>  |                   |                   |                        |
| Total Power Dissipation      | P <sub>T</sub>    | mW                | 225 / 450              |
| I/O Breakdown Voltage        | V <sub>I/O</sub>  | V <sub>rms</sub>  | 1500                   |
| Operating Temperature        | T <sub>opr</sub>  | °C                | -40 ~ +85              |
| Storage Temperature          | T <sub>stg</sub>  | °C                | -40 ~ +100             |

## CT248 / CS248 / CT348 / CS348 ELECTRICAL SPECIFICATIONS (Ambient Temperature: 25°C)

| Parameters                   | Symbol             | Test Conditions  | Units | Min             | Typ  | Max |
|------------------------------|--------------------|--|-------|-----------------|------|-----|
| <b>INPUT</b>                 |                    |  |       |                 |      |     |
| LED Forward Voltage          | V <sub>F</sub>     | I <sub>F</sub> =10mA   | V     | 1.0             | 1.17 | 1.5 |
| Operation LED Current        | I <sub>F On</sub>  |  | mA    |                 | 0.9  | 3.0 |
| Recovery LED Voltage         | V <sub>F off</sub> |  | V     | 0.5             | 1.0  |     |
| <b>OUTPUT</b>                |                    |  |       |                 |      |     |
| On-Resistance Drain to Drain | R <sub>On</sub>    | I <sub>F</sub> =5mA, I <sub>L</sub> =Rating<br>Time to flow is within 1 sec. | Ω     |                 | 2.0  | 3.5 |
| Off-State Leakage Current    | I <sub>Leak</sub>  | V <sub>L</sub> =100V   | μA    |                 |      | 1.0 |
| Output Capacitance           | C <sub>Out</sub>   | V <sub>L</sub> =100V, f=1MHz   | pF    |                 | 37   |     |
| <b>TRANSMISSION</b>          |                    |  |       |                 |      |     |
| Operate Time                 | T <sub>On</sub>    | I <sub>F</sub> =10mA, I <sub>L</sub> =Rating                                 | ms    |                 | 0.2  | 1.0 |
| Recovery Time                | T <sub>Off</sub>   | I <sub>F</sub> =10mA, I <sub>L</sub> =Rating                                 | ms    |                 | 0.05 | 1.0 |
| <b>COUPLED</b>               |                    |  |       |                 |      |     |
| I/O Insulation Resistance    | R <sub>I/O</sub>   |  | Ω     | 10 <sup>9</sup> |      |     |
| I/O Capacitance              | C <sub>I/O</sub>   | f=1MHz   | pF    |                 | 1.3  |     |

### Environmental Ratings:

Operating Temp: -40°C to +85°C; Storage Temp: -40 to +100 C.  
All electrical parameters measured at 25° C unless otherwise specified.

# 48 SERIES GRAPHS

