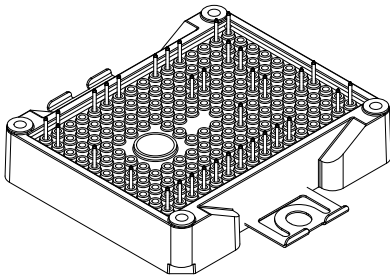
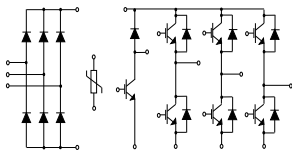

ACEPACK™ 2 converter inverter brake, 650 V, 50 A trench gate field-stop IGBT M series, soft diode and NTC

ACEPACK™ 2

Features

- ACEPACK™ 2 power module
 - DBC Cu Al₂O₃ Cu
- Converter inverter brake topology
 - 1600 V, very low drop rectifiers for converter
 - 650 V, 50 A IGBTs and diodes
 - Soft and fast recovery diode
- Integrated NTC

Applications

- Inverters
- Motor drives

Description

This power module is a converter-inverter brake (CIB) topology in an ACEPACK™ 2 package with NTC, integrating the advanced trench gate field-stop technology from STMicroelectronics. This new IGBT technology represents the best compromise between conduction and switching loss, to maximize the efficiency of any converter system up to 20 kHz.



Product status

A2C50S65M2

Product summary

Order code	A2C50S65M2
Marking	A2C50S65M2
Package	ACEPACK™ 2
Leads type	Solder contact pins

1 Electrical ratings

1.1 Inverter stage

Limiting values at $T_J = 25\text{ °C}$, unless otherwise specified.

1.1.1 IGBTs

Table 1. Absolute maximum ratings of the IGBTs, inverter stage

Symbol	Description	Value	Unit
V_{CES}	Collector-emitter voltage ($V_{GE} = 0\text{ V}$)	650	V
I_C	Continuous collector current ($T_C = 100\text{ °C}$)	50	A
$I_{CP}^{(1)}$	Pulsed collector current ($t_p = 1\text{ ms}$)	100	A
V_{GE}	Gate-emitter voltage	± 20	V
P_{TOT}	Total power dissipation of each IGBT ($T_C = 25\text{ °C}$, $T_J = 175\text{ °C}$)	208	W
T_{JMAX}	Maximum junction temperature	175	$^{\circ}\text{C}$
T_{Jop}	Operating junction temperature range under switching conditions	-40 to 150	$^{\circ}\text{C}$

1. Pulse width limited by maximum junction temperature

Table 2. Electrical characteristics of the IGBTs, inverter stage

Symbol	Parameter	Test conditions	Min.	Typ.	Max.	Unit
$V_{(BR)CES}$	Collector-emitter breakdown voltage	$I_C = 1\text{ mA}$, $V_{GE} = 0\text{ V}$	650			V
$V_{CE(sat)}$ (terminal)	Collector-emitter saturation voltage	$V_{GE} = 15\text{ V}$, $I_C = 50\text{ A}$		1.95	2.3	V
		$V_{GE} = 15\text{ V}$, $I_C = 50\text{ A}$, $T_J = 150\text{ °C}$		2.3		V
$V_{GE(th)}$	Gate threshold voltage	$V_{CE} = V_{GE}$, $I_C = 1\text{ mA}$	5	6	7	V
I_{CES}	Collector cut-off current	$V_{GE} = 0\text{ V}$, $V_{CE} = 650\text{ V}$			100	μA
I_{GES}	Gate-emitter leakage current	$V_{CE} = 0\text{ V}$, $V_{GE} = \pm 20\text{ V}$			± 500	nA
C_{ies}	Input capacitance	$V_{CE} = 25\text{ V}$, $f = 1\text{ MHz}$, $V_{GE} = 0\text{ V}$		4150		pF
C_{oes}	Output capacitance			170		pF
C_{res}	Reverse transfer capacitance			80		pF
Q_g	Total gate charge	$V_{CC} = 520\text{ V}$, $I_C = 50\text{ A}$, $V_{GE} = \pm 15\text{ V}$		150		nC
$t_{d(on)}$	Turn-on delay time	$V_{CC} = 300\text{ V}$, $I_C = 50\text{ A}$, $R_G = 6.8\ \Omega$, $V_{GE} = \pm 15\text{ V}$, $di/dt = 2320\text{ A}/\mu\text{s}$		147		ns
t_r	Current rise time			17.5		ns
$E_{on}^{(1)}$	Turn-on switching energy			0.147		mJ

Symbol	Parameter	Test conditions	Min.	Typ.	Max.	Unit
$t_{d(off)}$	Turn-off delay time	$V_{CC} = 300\text{ V}$, $I_C = 50\text{ A}$,		105		ns
t_f	Current fall time	$R_G = 6.8\ \Omega$, $V_{GE} = \pm 15\text{ V}$,		133		ns
$E_{off}^{(2)}$	Turn-off switching energy	$dv/dt = 7400\text{ V}/\mu\text{s}$		1.36		mJ
$t_{d(on)}$	Turn-on delay time	$V_{CC} = 300\text{ V}$, $I_C = 50\text{ A}$,		147		ns
t_r	Current rise time	$R_G = 6.8\ \Omega$, $V_{GE} = \pm 15\text{ V}$,		20		ns
$E_{on}^{(1)}$	Turn-on switching energy	$di/dt = 2010\text{ A}/\mu\text{s}$, $T_J = 150\text{ }^\circ\text{C}$		0.318		mJ
$t_{d(off)}$	Turn-off delay time	$V_{CC} = 300\text{ V}$, $I_C = 50\text{ A}$,		104		ns
t_f	Current fall time	$R_G = 6.8\ \Omega$, $V_{GE} = \pm 15\text{ V}$,		194		ns
$E_{off}^{(2)}$	Turn-off switching energy	$dv/dt = 6000\text{ V}/\mu\text{s}$, $T_J = 150\text{ }^\circ\text{C}$		1.82		mJ
t_{SC}	Short-circuit withstand time	$V_{CC} \leq 360\text{ V}$, $V_{GE} \leq 15\text{ V}$, $T_{Jstart} \leq 150\text{ }^\circ\text{C}$	6			μs
R_{THj-c}	Thermal resistance junction-to-case	Each IGBT		0.65	0.72	$^\circ\text{C}/\text{W}$
R_{THc-h}	Thermal resistance case-to-heatsink	Each IGBT, $\lambda_{grease} = 1\text{ W}/(\text{m}\cdot^\circ\text{C})$		0.79		$^\circ\text{C}/\text{W}$

1. Including the reverse recovery of the diode.
2. Including the tail of the collector current.

1.1.2

Diode

Limiting values at $T_J = 25\text{ }^\circ\text{C}$, unless otherwise specified.

Table 3. Absolute maximum ratings of the diode, inverter stage

Symbol	Parameter	Value	Unit
V_{RRM}	Repetitive peak reverse voltage	650	V
I_F	Continuous forward current ($T_C = 100\text{ }^\circ\text{C}$)	50	A
$I_{FP}^{(1)}$	Pulsed forward current ($t_p = 1\text{ ms}$)	100	A
T_{JMAX}	Maximum junction temperature	175	$^\circ\text{C}$
T_{Jop}	Operating junction temperature range under switching conditions	-40 to 150	$^\circ\text{C}$

1. Pulse width limited by maximum junction temperature

Table 4. Electrical characteristics of the diode, inverter stage

Symbol	Parameter	Test conditions	Min.	Typ.	Max.	Unit
V_F (terminal)	Forward voltage	$I_F = 50\text{ A}$	-	1.85	2.65	V
		$I_F = 50\text{ A}$, $T_J = 150\text{ }^\circ\text{C}$	-	1.65		
t_{rr}	Reverse recovery time	$I_F = 50\text{ A}$, $V_R = 300\text{ V}$, $V_{GE} = \pm 15\text{ V}$, $di_F/dt = 2320\text{ A}/\mu\text{s}$	-	155		ns
Q_{rr}	Reverse recovery charge		-	2.32		μC
I_{rrm}	Reverse recovery current		-	41		A
E_{rec}	Reverse recovery energy		-	0.53		mJ

Symbol	Parameter	Test conditions	Min.	Typ.	Max.	Unit
t_{rr}	Reverse recovery time	$I_F = 50\text{ A}$, $V_R = 300\text{ V}$, $V_{GE} = \pm 15\text{ V}$, $di_F/dt = 2010\text{ A}/\mu\text{s}$, $T_J = 150\text{ }^\circ\text{C}$	-	270		ns
Q_{rr}	Reverse recovery charge		-	5.98		μC
I_{rrm}	Reverse recovery current		-	62		A
E_{rec}	Reverse recovery energy		-	1.6		mJ
R_{THj-c}	Thermal resistance junction-to-case	Each diode	-	1.0	1.1	$^\circ\text{C}/\text{W}$
R_{THc-h}	Thermal resistance case-to-heatsink	Each diode, $\lambda_{grease} = 1\text{ W}/(\text{m}\cdot^\circ\text{C})$	-	0.9		$^\circ\text{C}/\text{W}$

1.2 Brake stage

Limiting values at $T_J = 25\text{ }^\circ\text{C}$, unless otherwise specified.

1.2.1 IGBT

Table 5. Absolute maximum ratings of the IGBT, brake stage

Symbol	Parameter	Value	Unit
V_{CES}	Collector-emitter voltage ($V_{GE} = 0$)	650	V
I_C	Continuous collector current ($T_C = 100\text{ }^\circ\text{C}$)	50	A
$I_{CP}^{(1)}$	Pulsed collector current ($t_p = 1\text{ ms}$)	100	A
V_{GE}	Gate-emitter voltage	± 20	V
P_{TOT}	Total power dissipation of each IGBT ($T_C = 25\text{ }^\circ\text{C}$, $T_J = 175\text{ }^\circ\text{C}$)	208	W
T_{JMAX}	Maximum junction temperature	175	$^\circ\text{C}$
T_{Jop}	Operating junction temperature range under switching conditions	-40 to 150	$^\circ\text{C}$

1. Pulse width limited by maximum junction temperature

Table 6. Electrical characteristics of the IGBT, brake stage

Symbol	Parameter	Test conditions	Min.	Typ.	Max.	Unit
$V_{(BR)CES}$	Collector-emitter breakdown voltage	$I_C = 1\text{ mA}$, $V_{GE} = 0\text{ V}$	650			V
$V_{CE(sat)}$ (terminal)	Collector-emitter saturation voltage	$V_{GE} = 15\text{ V}$, $I_C = 50\text{ A}$		1.95		V
		$V_{GE} = 15\text{ V}$, $I_C = 50\text{ A}$, $T_J = 150\text{ }^\circ\text{C}$		2.3		
$V_{GE(th)}$	Gate threshold voltage	$V_{CE} = V_{GE}$, $I_C = 1\text{ mA}$	5	6	7	V
I_{CES}	Collector cut-off current	$V_{GE} = 0\text{ V}$, $V_{CE} = 650\text{ V}$			100	μA
I_{GES}	Gate-emitter leakage current	$V_{CE} = 0\text{ V}$, $V_{GE} = \pm 20\text{ V}$			± 500	nA
C_{ies}	Input capacitance	$V_{CE} = 25\text{ V}$, $f = 1\text{ MHz}$, $V_{GE} = 0\text{ V}$		4150		pF
C_{oes}	Output capacitance			170		pF
C_{res}	Reverse transfer capacitance			80		pF
Q_g	Total gate charge	$V_{CC} = 520\text{ V}$, $I_C = 50\text{ A}$, $V_{GE} = \pm 15\text{ V}$		150		nC

Symbol	Parameter	Test conditions	Min.	Typ.	Max.	Unit
$t_{d(on)}$	Turn-on delay time	$V_{CC} = 300\text{ V}$, $I_C = 50\text{ A}$, $R_G = 6.8\ \Omega$, $V_{GE} = \pm 15\text{ V}$, $di/dt = 2320\text{ A}/\mu\text{s}$		147		ns
t_r	Current rise time			17.5		ns
$E_{on}^{(1)}$	Turn-on switching energy			0.147		mJ
$t_{d(off)}$	Turn-off delay time	$V_{CC} = 300\text{ V}$, $I_C = 50\text{ A}$, $R_G = 6.8\ \Omega$, $V_{GE} = \pm 15\text{ V}$, $dv/dt = 7400\text{ V}/\mu\text{s}$		105		ns
t_f	Current fall time			133		ns
$E_{off}^{(2)}$	Turn-off switching energy			1.36		mJ
$t_{d(on)}$	Turn-on delay time	$V_{CC} = 300\text{ V}$, $I_C = 50\text{ A}$, $R_G = 6.8\ \Omega$, $V_{GE} = \pm 15\text{ V}$, $di/dt = 2010\text{ A}/\mu\text{s}$, $T_J = 150\text{ }^\circ\text{C}$		147		ns
t_r	Current rise time			20		ns
$E_{on}^{(1)}$	Turn-on switching energy			0.318		mJ
$t_{d(off)}$	Turn-off delay time	$V_{CC} = 300\text{ V}$, $I_C = 50\text{ A}$, $R_G = 6.8\ \Omega$, $V_{GE} = \pm 15\text{ V}$, $dv/dt = 6000\text{ V}/\mu\text{s}$, $T_J = 150\text{ }^\circ\text{C}$		104		ns
t_f	Current fall time			194		ns
$E_{off}^{(2)}$	Turn-off switching energy			1.82		mJ
t_{SC}	Short-circuit withstand time	$V_{CC} \leq 360\text{ V}$, $V_{GE} \leq 15\text{ V}$, $T_{Jstart} \leq 150\text{ }^\circ\text{C}$	6			μs
R_{THj-c}	Thermal resistance junction-to-case	Each IGBT		0.65	0.72	$^\circ\text{C}/\text{W}$
R_{THc-h}	Thermal resistance case-to-heatsink	Each IGBT, $\lambda_{grease} = 1\text{ W}/(\text{m}\cdot^\circ\text{C})$		0.79		$^\circ\text{C}/\text{W}$

1. Including the reverse recovery of the diode
2. Including the tail of the collector current

1.2.2

Diode

Table 7. Absolute maximum ratings of the diode, brake stage

Symbol	Parameter	Value	Unit
V_{RRM}	Repetitive peak reverse voltage	650	V
I_F	Continuous forward current ($T_C = 100\text{ }^\circ\text{C}$)	50	A
$I_{FP}^{(1)}$	Pulsed forward current ($t_p = 1\text{ ms}$)	100	A
T_{JMAX}	Maximum junction temperature	175	$^\circ\text{C}$
T_{Jop}	Operating junction temperature range under switching conditions	-40 to 150	$^\circ\text{C}$

1. Pulse width limited by maximum junction temperature.

Table 8. Electrical characteristics of the diode, brake stage

Symbol	Parameter	Test conditions	Min.	Typ.	Max.	Unit
V_F (terminal)	Forward voltage	$I_F = 50\text{ A}$	-	1.85		V
		$I_F = 50\text{ A}$, $T_J = 150\text{ }^\circ\text{C}$	-	1.65		
t_{rr}	Reverse recovery time	$I_F = 50\text{ A}$, $V_R = 300\text{ V}$, $V_{GE} = \pm 15\text{ V}$, $di/dt = 2320\text{ A}/\mu\text{s}$	-	155		ns
Q_{rr}	Reverse recovery charge		-	2.32		μC
I_{rrm}	Reverse recovery current		-	41		A
E_{rec}	Reverse recovery energy		-	0.53		mJ

Symbol	Parameter	Test conditions	Min.	Typ.	Max.	Unit
t_{rr}	Reverse recovery time	$I_F = 50 \text{ A}$, $V_R = 300 \text{ V}$, $V_{GE} = \pm 15 \text{ V}$, $di/dt = 2010 \text{ A}/\mu\text{s}$, $T_J = 150 \text{ }^\circ\text{C}$	-	270		ns
Q_{rr}	Reverse recovery charge		-	5.98		μC
I_{rrm}	Reverse recovery current		-	62		A
E_{rec}	Reverse recovery energy		-	1.6		mJ
R_{THj-c}	Thermal resistance junction-to-case	Each diode	-	1.0	1.1	$^\circ\text{C}/\text{W}$
R_{THc-h}	Thermal resistance case-to-heatsink	Each diode, $\lambda_{grease} = 1 \text{ W}/(\text{m}\cdot^\circ\text{C})$	-	0.9		$^\circ\text{C}/\text{W}$

1.3

Converter stage

Limiting values at $T_J = 25 \text{ }^\circ\text{C}$, unless otherwise specified.

Table 9. Absolute maximum ratings of the bridge rectifiers

Symbol	Description	Value	Unit
V_{RRM}	Repetitive peak reverse voltage	1600	V
I_F	RMS forward current	50	A
I_{FSM}	Forward surge current $t_p = 10 \text{ ms}$, $T_C = 25 \text{ }^\circ\text{C}$	450	A
	Forward surge current $t_p = 10 \text{ ms}$, $T_C = 150 \text{ }^\circ\text{C}$	365	
I^2t	$t_p = 10 \text{ ms}$, $T_C = 25 \text{ }^\circ\text{C}$	1012	A^2s
	$t_p = 10 \text{ ms}$, $T_C = 150 \text{ }^\circ\text{C}$	666	
T_{JMAX}	Maximum junction temperature	175	$^\circ\text{C}$
T_{Jop}	Operating junction temperature range under switching conditions	-40 to 150	$^\circ\text{C}$

Table 10. Electrical characteristics of the bridge rectifiers

Symbol	Parameter	Test conditions	Min.	Typ.	Max.	Unit
V_F (terminal)	Forward voltage	$I_F = 50 \text{ A}$	-	1.23	1.6	V
		$I_F = 50 \text{ A}$, $T_J = 150 \text{ }^\circ\text{C}$	-	1.14		
I_R	Reverse current	$T_J = 150 \text{ }^\circ\text{C}$, $V_R = 1600 \text{ V}$	-	1		mA
R_{THj-c}	Thermal resistance junction-to-case	Each diode	-	1.00	1.10	$^\circ\text{C}/\text{W}$
R_{THc-h}	Thermal resistance case-to-heatsink	Each diode, $\lambda_{grease} = 1 \text{ W}/(\text{m}\cdot^\circ\text{C})$	-	0.95		$^\circ\text{C}/\text{W}$

1.4 NTC

Table 11. NTC temperature sensor, considered as stand-alone

Symbol	Parameter	Test conditions	Min.	Typ.	Max.	Unit
R ₂₅	Resistance	T = 25 °C		5		kΩ
R ₁₀₀	Resistance	T = 100 °C		493		Ω
ΔR/R	Deviation of R ₁₀₀		-5		+5	%
B _{25/50}	B-constant			3375		K
B _{25/80}	B-constant			3411		K
T	Operating temperature range		-40		150	°C

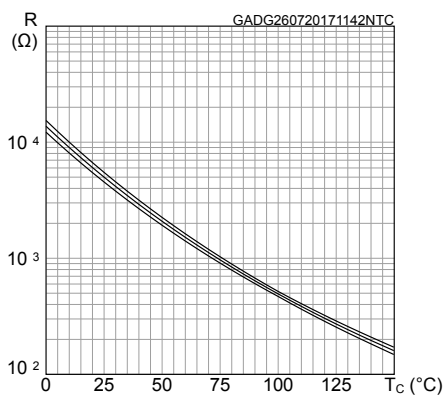
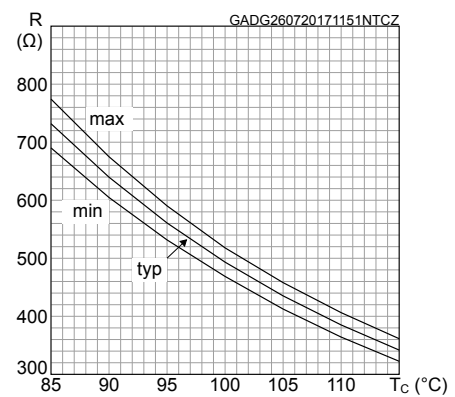
Figure 1. NTC resistance vs temperature

Figure 2. NTC resistance vs temperature, zoom

1.5 Package

Table 12. ACEPACK™ 2 package

Symbol	Parameter	Min.	Typ.	Max.	Unit
V _{isol}	Isolation voltage (AC voltage, t = 60 s)			2500	Vrms
T _{stg}	Storage temperature	-40		125	°C
CTI	Comparative tracking index	200			
L _s	Stray inductance module P1 - EW loop		33.5		nH
R _s	Module single lead resistance, terminal to chip		3.6		mΩ

2 Electrical characteristics (curves)

Figure 3. IGBT output characteristics
($V_{GE} = 15\text{ V}$, terminal)

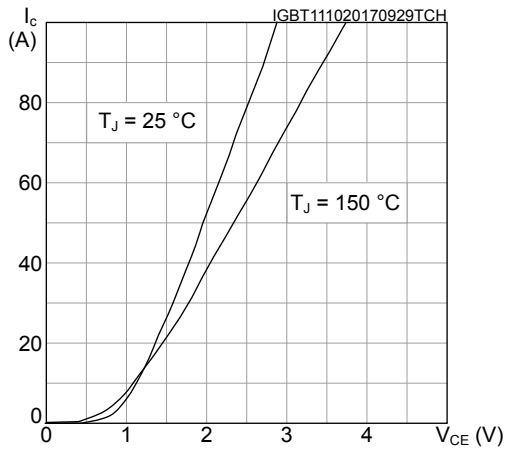

Figure 4. IGBT output characteristics
($T_J = 150\text{ °C}$, terminal)

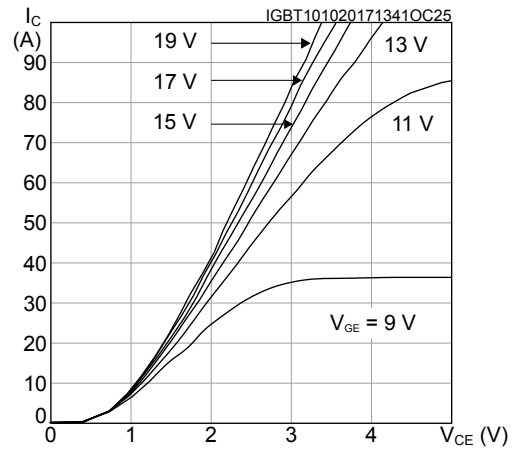

Figure 5. IGBT transfer characteristics
($V_{CE} = 15\text{ V}$, terminal)

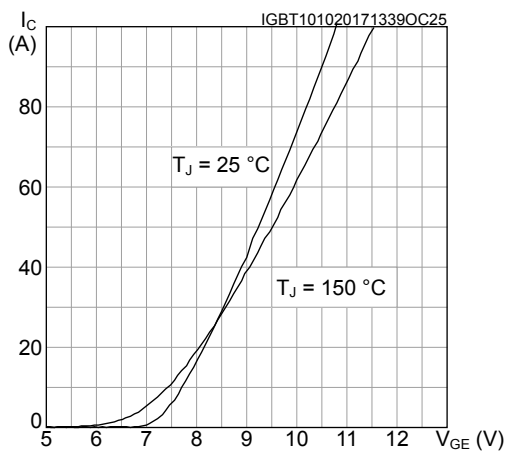

Figure 6. IGBT collector current vs case temperature

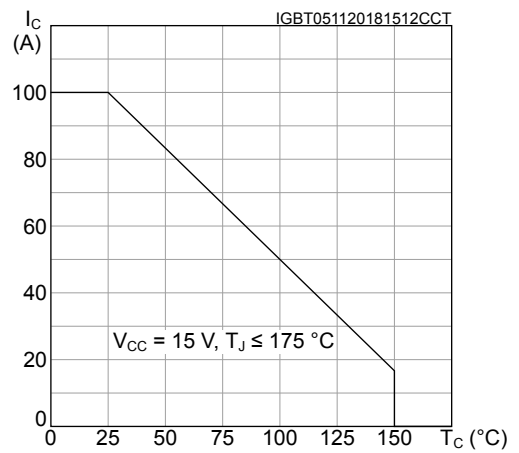

Figure 7. Switching energy vs gate resistance

Figure 8. Switching energy vs collector current

Figure 9. IGBT reverse biased safe operating area (RBSOA)

Figure 10. Diode forward characteristics (terminal)

Figure 11. Diode reverse recovery energy vs diode current slope

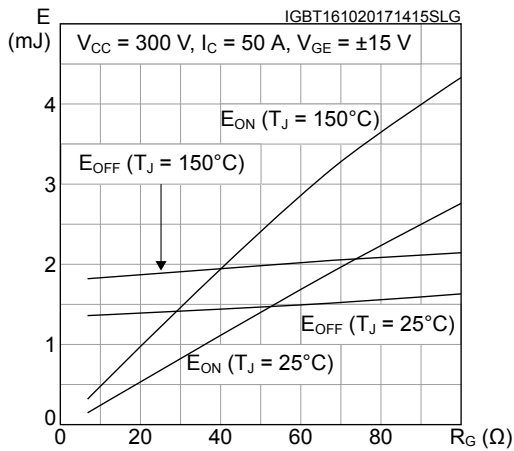
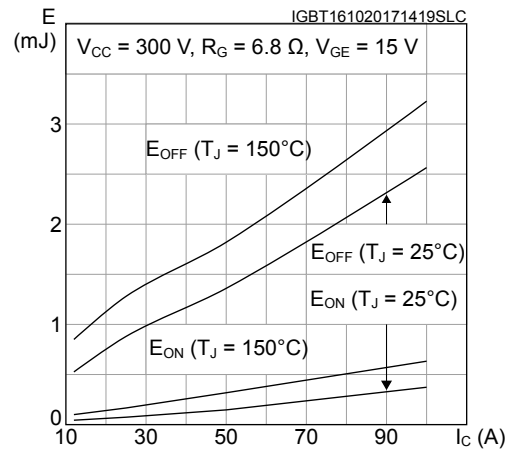
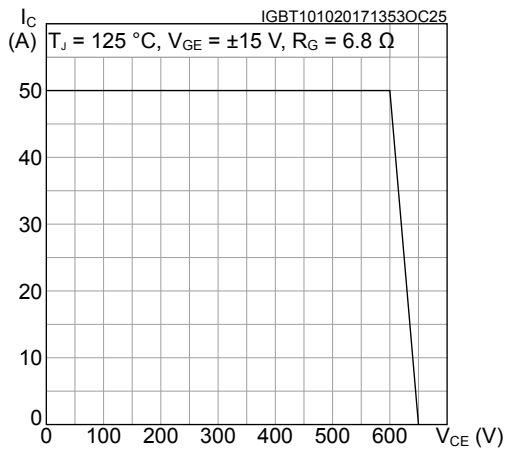
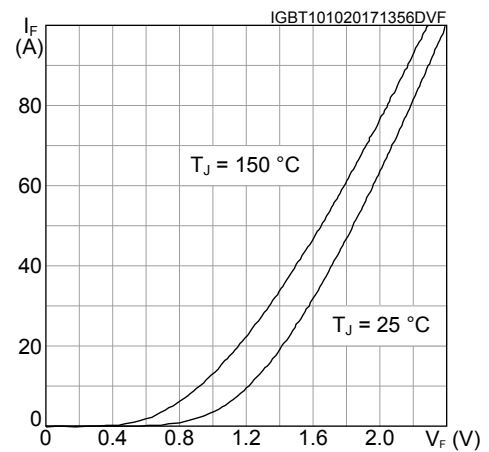
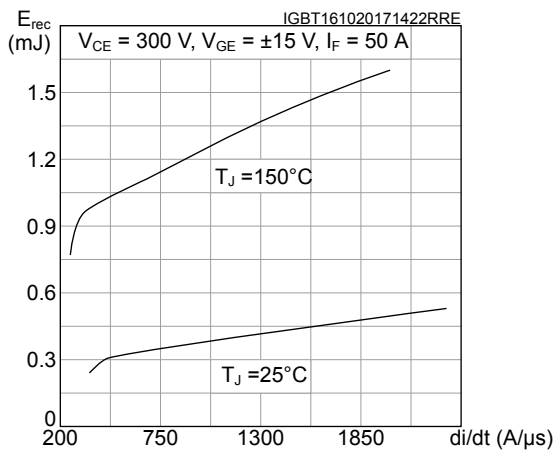
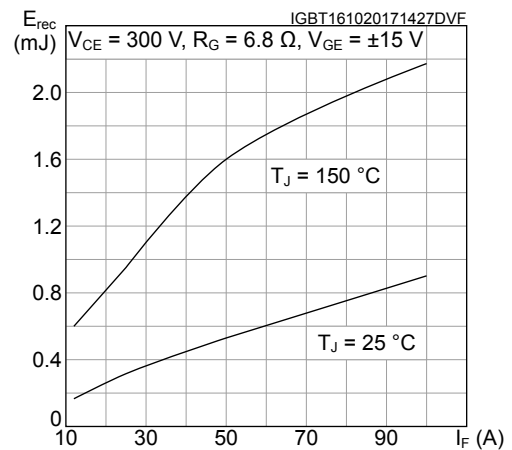
Figure 12. Diode reverse recovery energy vs forward current

Figure 13. Diode reverse recovery energy vs gate resistance

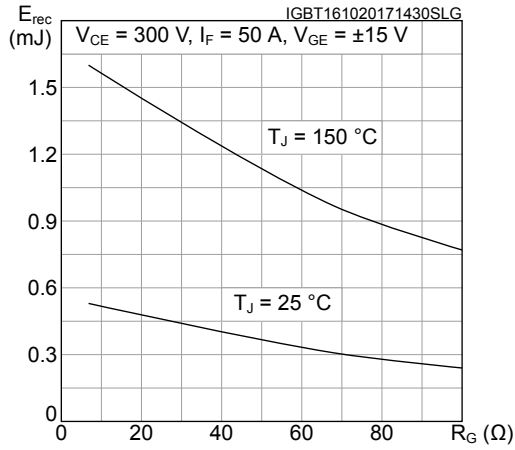

Figure 14. Converter diode forward characteristics (terminal)

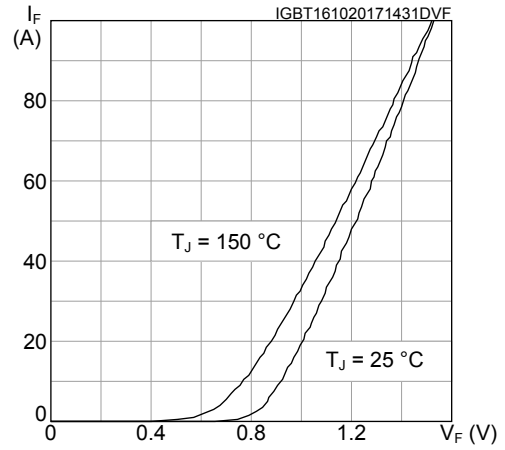

Figure 15. IGBT thermal impedance

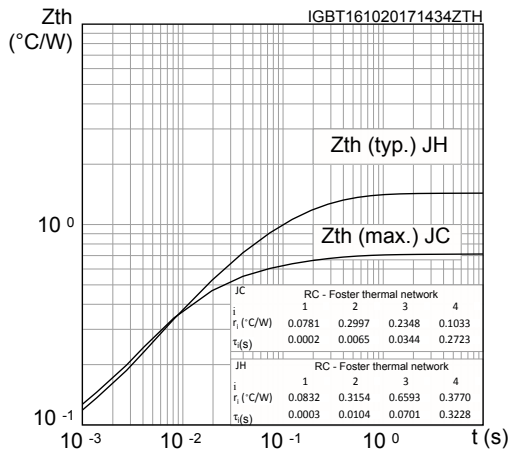
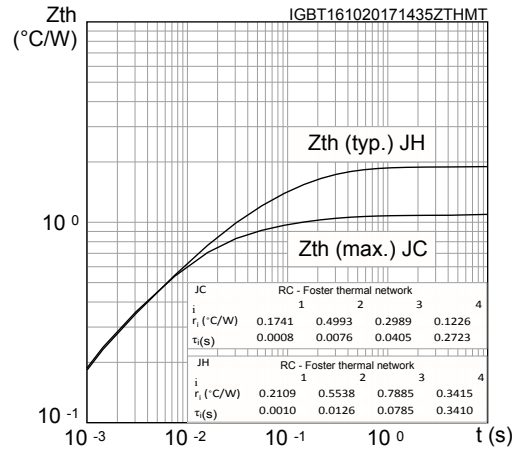
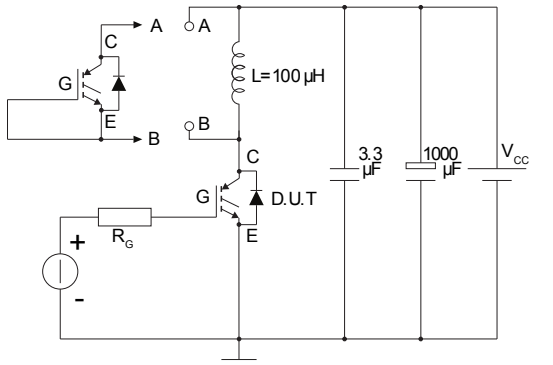
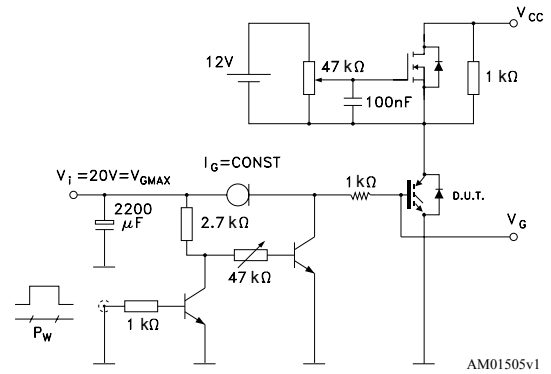
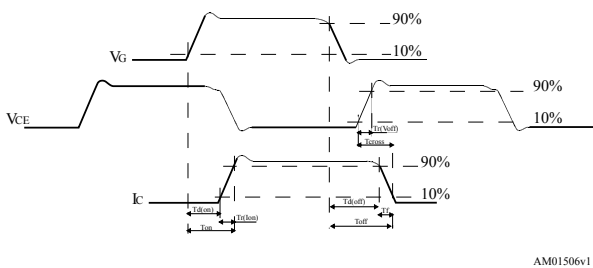
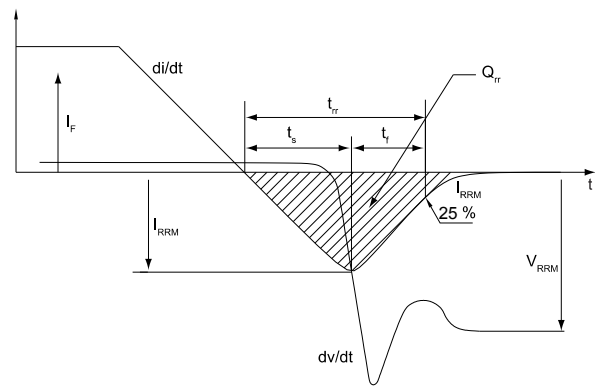

Figure 16. Inverter diode thermal impedance



3 Test circuits

Figure 17. Test circuit for inductive load switching

Figure 18. Gate charge test circuit

Figure 19. Switching waveform

Figure 20. Diode reverse recovery waveform

4 Topology and pin description

Figure 21. Electrical topology and pin description

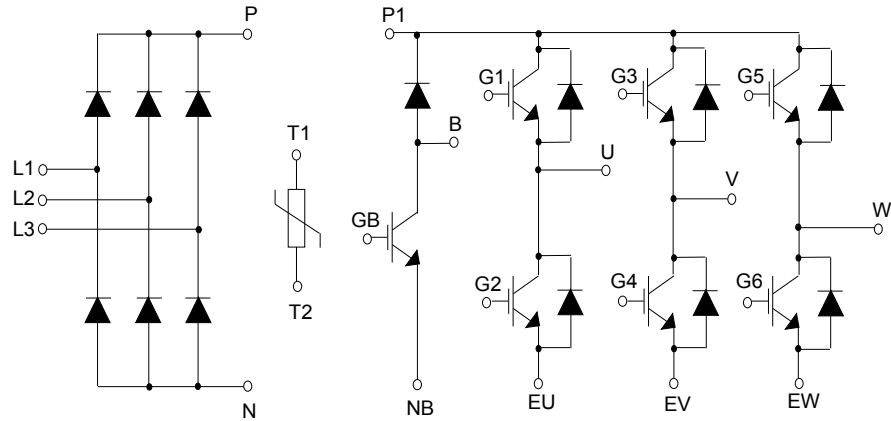
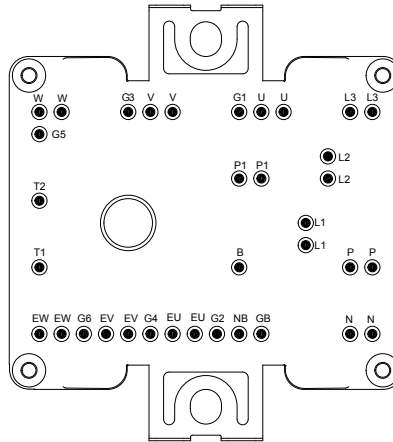

Figure 22. Package top view with CIB pinout



5 Package information

In order to meet environmental requirements, ST offers these devices in different grades of **ECOPACK®** packages, depending on their level of environmental compliance. ECOPACK® specifications, grade definitions and product status are available at: www.st.com. ECOPACK® is an ST trademark.

5.1 ACEPACK™ 2 CIB solder pins package information

Figure 23. ACEPACK™ 2 CIB solder pins package outline (dimensions are in mm)

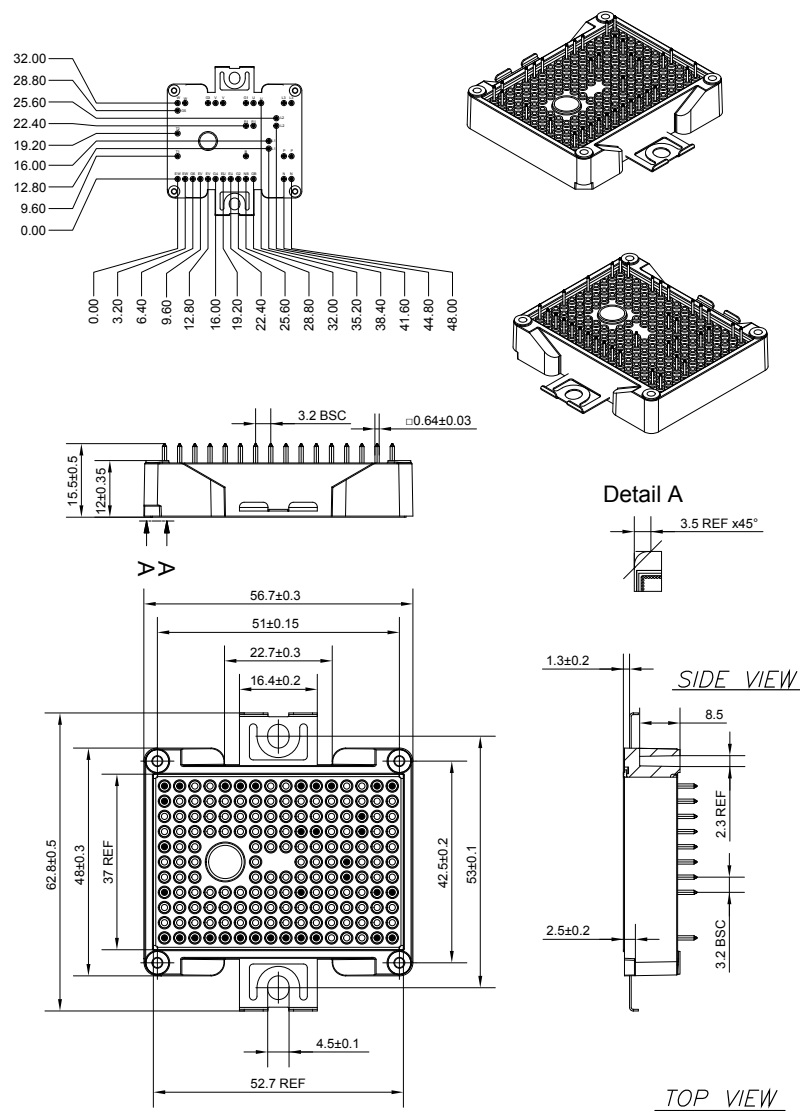

8569722_ACEPACK2_CIB_solderable_pins

- The lead size includes the thickness of the lead plating material.
- Dimensions do not include mold protrusion.
- Package dimensions do not include any eventual metal burrs.

Revision history

Table 13. Document revision history

Date	Revision	Changes
16-Oct-2017	1	Initial release
02-Mar-2018	2	<p>Removed maturity status indication from cover page. The document status is production data.</p> <p>Updated features on cover page.</p> <p>Updated Table 10. Electrical characteristics of the bridge rectifiers.</p> <p>Updated Figure 15. IGBT thermal impedance and Figure 16. Inverter diode thermal impedance.</p> <p>Updated Figure 23. ACEPACK™ 2 CIB solder pins package outline (dimensions are in mm).</p> <p>Minor text changes</p>
19-Nov-2018	3	<p>Added Section STPOWER LOGO and Figure 6. IGBT collector current vs case temperature.</p>

Contents

1	Electrical ratings	2
1.1	Inverter stage	2
1.1.1	IGBTs	2
1.1.2	Diode	3
1.2	Brake stage	4
1.2.1	IGBT	4
1.2.2	Diode	5
1.3	Converter stage	6
1.4	NTC	7
1.5	Package	7
2	Electrical characteristics (curves)	8
3	Test circuits	11
4	Topology and pin description	12
5	Package information	13
5.1	ACEPACK™ 2 CIB solder pins package information	13
	Revision history	14
	Contents	15
	@NA	16

IMPORTANT NOTICE – PLEASE READ CAREFULLY

STMicroelectronics NV and its subsidiaries (“ST”) reserve the right to make changes, corrections, enhancements, modifications, and improvements to ST products and/or to this document at any time without notice. Purchasers should obtain the latest relevant information on ST products before placing orders. ST products are sold pursuant to ST’s terms and conditions of sale in place at the time of order acknowledgement.

Purchasers are solely responsible for the choice, selection, and use of ST products and ST assumes no liability for application assistance or the design of Purchasers’ products.

No license, express or implied, to any intellectual property right is granted by ST herein.

Resale of ST products with provisions different from the information set forth herein shall void any warranty granted by ST for such product.

ST and the ST logo are trademarks of ST. All other product or service names are the property of their respective owners.

Information in this document supersedes and replaces information previously supplied in any prior versions of this document.

© 2018 STMicroelectronics – All rights reserved