

LIGHT LED M08 CoB Product Series

1. Description

The LiteON CoB Product series is a revolutionary, energy efficient and ultra-compact new light source, combining the lifetime and reliability advantages of Light Emitting Diodes with the brightness of conventional lighting. It gives you total design freedom and unmatched brightness, creating a new opportunities for solid state lighting to displace conventional lighting technologies.

1.1 Features

- Compact high flux density light source
- Uniform high quality illumination
- Streamlined thermal path
- MacAdam compliant binning structure
More energy efficient than incandescent, halogen and fluorescent lamps
- Instant light with unlimited dimming
- RoHS compliant and Pb free

1.2 Benefits Features

- Enhanced optical control
- Clean white light without pixilation
- Uniform consistent white light
- Significantly reduced thermal resistance and increased operating temperatures
- Lower operating costs
- Reduced maintenance costs

1.3 Naming Rule

L T P L - M 0 8 2 X X Z S X X - X X

Code1
Code2
Code3
Code4
Code5
Code6
Code7

Code 1: Product Line

PL: High Power LED

Code 2: Package Type/Platform

M08: Metal substrate with 13.5x13.5mm square.

Code 3: Light Emitting Surface

2: 9.5mm excluding dam

Code 4: Product Series

06: 06 Series

10: 10 Series

18: 18 Series

Code5: Emission Color Characteristics

Z: White Color Rendering Index 80 Min.

Q: White Color Rendering Index 90 Min.

Code6: Color Temperature

27: 2700K at 85degC

30: 3000K at 85degC

40: 4000K at 85degC

Note: The Color Temperature follow ANSI C78.377A Doc.

Code7: Hue Bin by MacAdam Ellipses Step

T0: 2700~4000K MacAdam Ellipse / ANSI Bin

LIGHT LED M08 CoB Product Series

1.4 Product List

PN	Series	CCT	CRI	Color Bin			Lumen Bin	
				3SDCM	5SDCM	ANSI	-8%~+8%	-15%~+15%
LTPL-M08206ZS27-T0	6	2700K	80	☆	☆	☆	☆	☆
LTPL-M08206ZS30-T0	6	3000K	80	☆	☆	☆	☆	☆
LTPL-M08206ZS40-T0	6	4000K	80	☆	☆	☆	☆	☆
LTPL-M08210ZS27-T0	10	2700K	80	☆	☆	☆	☆	☆
LTPL-M08210ZS30-T0	10	3000K	80	☆	☆	☆	☆	☆
LTPL-M08210ZS40-T0	10	4000K	80	☆	☆	☆	☆	☆
LTPL-M08218ZS27-T0	18	2700K	80	☆	☆	☆	☆	☆
LTPL-M08218ZS30-T0	18	3000K	80	☆	☆	☆	☆	☆
LTPL-M08218ZS40-T0	18	4000K	80	☆	☆	☆	☆	☆
LTPL-M08206QS30-T0	6	3000K	90	☆	☆	☆	☆	☆
LTPL-M08210QS30-T0	10	3000K	90	☆	☆	☆	☆	☆
LTPL-M08218QS30-T0	18	3000K	90	☆	☆	☆	☆	☆

LIGHT LED M08 CoB Product Series

2. Outline Dimensions

2.1 Form Factor of M082 series CoB



Notes

1. All dimensions are in millimeters.
2. Tolerance is ± 0.3 mm unless otherwise noted.

2.2 Internal Equivalent Circuit

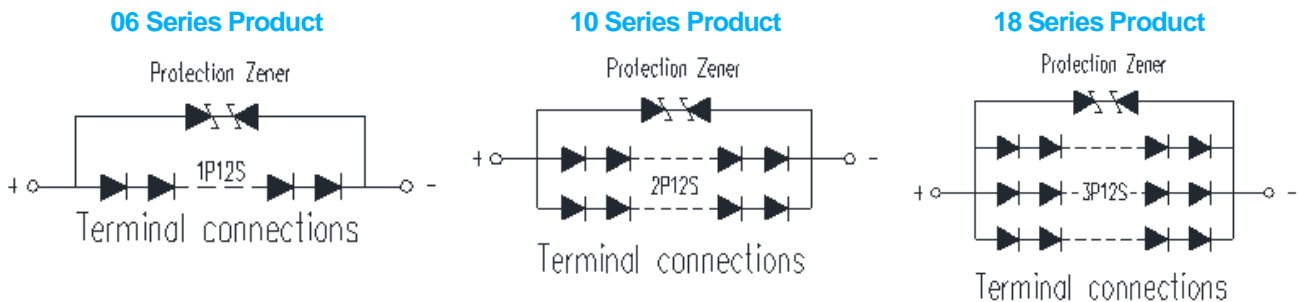

Notes

1. LED of equivalent circuit means all series/parallel in CoB package.

LIGHT LED M08 CoB Product Series

3. Absolute Maximum Ratings at Ta=25°C

Parameter	Symbol	Product Series	Rating	Unit
Power Dissipation	P _O	6	8	W
		10	16	
		18	24	
Forward Current	I _F	6	200	mA
		10	400	
		18	600	
Junction Temperature	T _J		125	°C
Thermal Resistance, Junction-Case	R _{th, J-C}	6	2.04	°C/W
		10	1.2	
		18	0.9	
Operating Temperature Range	T _{opr}		-40 to 85	°C
Storage Temperature Range	T _{stg}		-40 to 100	°C

Notes

1. The pulse mode condition is 1/10 duty cycle with 100 msec. pulse width.
2. Forbid to be operated at reverse voltage condition.
3. The unit of Rth is °C/W electrical.
4. The M08 CoB is recommended soldering temperature under 350degC and could not over 3.5sec.

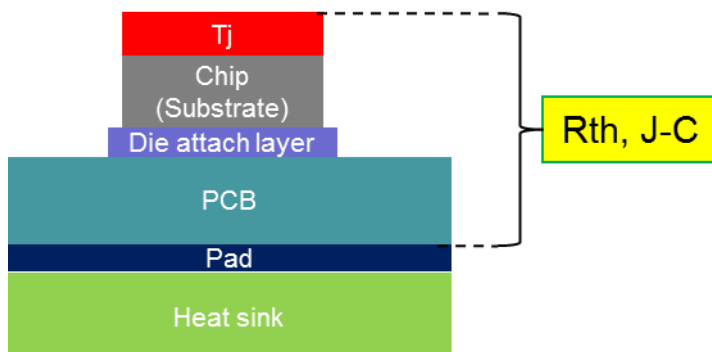

LIGHT LED M08 CoB Product Series

4. Electro-Optical Characteristics

4.1 Typical Performance

Dominant CCT	Product Series	CRI min.	Current (mA)	V _F (V) @25°C	Flux(lm) @25°C	V _F (V) @85°C	Flux(lm) @85°C	Eff.(lm/W) @25°C	Eff.(lm/W) @85°C
2700K	6	80	120	37.0	596	35.8	531	134	124
	10	80	240	37.0	1121	35.8	998	126	116
	18	80	360	37.0	1720	35.8	1531	129	119
3000K	6	80	120	37.0	621	35.8	553	140	129
	10	80	240	37.0	1168	35.8	1040	132	121
	18	80	360	37.0	1792	35.8	1595	135	124
4000K	6	80	120	37.0	658	35.8	586	148	136
	10	80	240	37.0	1238	35.8	1102	139	128
	18	80	360	37.0	1900	35.8	1691	143	131
3000K	6	90	120	37.0	515	35.8	459	116	107
	10	90	240	37.0	969	35.8	863	109	100
	18	90	360	37.0	1487	35.8	1324	112	103

Notes

1. All of V_F value are typical, the real bin range please refer page 16 "V_F Binning Parameter".
2. All of flux value are typical, the real bin range please refer page 13 "Flux Binning Parameter".
3. Tolerance of flux is ±7%, tolerance of CCX/CCY is ±0.007, tolerance of CRI is ±2, and tolerance of V_F is ±3%.
4. Typical viewing angle is 120deg.

LIGHT LED M08 CoB Product Series

4.2 Forward Current vs. Lumen Voltage

■ 06 Series Product

Current	VF	Lumen (lm)			
		CRI 80			CRI 90
(mA)	(V)	2700K	3000K	4000K	3000K
60	34.5	323	337	357	280
70	34.9	371	387	410	321
80	35.3	419	436	462	362
90	35.7	466	485	514	403
100	36.1	507	529	560	439
110	36.6	554	577	611	479
120	37.0	596	621	658	515
130	37.4	636	663	702	550
140	37.8	677	705	747	585
150	38.2	714	744	788	617
160	38.7	757	788	836	654
170	39.1	793	826	875	686
180	39.5	829	863	915	716
200	40.3	912	950	1007	789

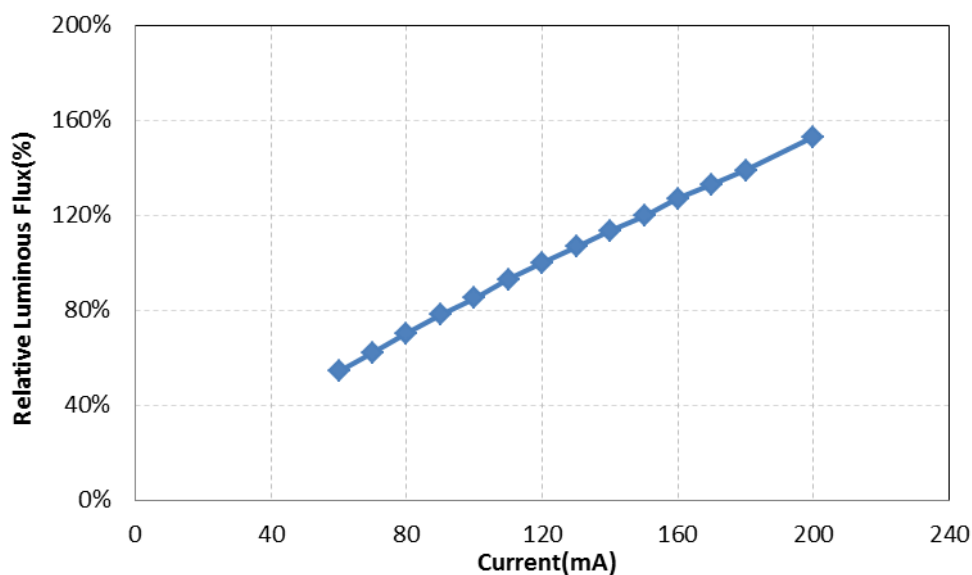

LIGHT LED M08 CoB Product Series

■ 10 Series Product

Current (mA)	VF (V)	Lumen (lm)			
		CRI 80			CRI 90
		2700K	3000K	4000K	3000K
120	34.5	608	634	672	526
140	34.9	698	727	771	603
160	35.3	790	822	872	683
180	35.7	877	913	968	758
200	36.1	956	996	1056	827
220	36.6	1040	1084	1149	900
240	37.0	1121	1168	1238	969
260	37.4	1204	1254	1330	1041
280	37.8	1266	1318	1397	1094
300	38.2	1347	1403	1487	1164
320	38.7	1415	1474	1562	1223
340	39.1	1490	1552	1645	1288
360	39.5	1567	1633	1731	1355
400	40.3	1727	1799	1907	1493



LIGHT LED M08 CoB Product Series

■ 18 Series Product

Current (mA)	VF (V)	Lumen (lm)			
		CRI 80			CRI 90
		2700K	3000K	4000K	3000K
150	34.0	800	833	883	691
180	34.5	943	983	1042	816
210	34.9	1089	1134	1202	941
240	35.3	1229	1280	1357	1062
270	35.7	1366	1423	1508	1181
300	36.1	1482	1544	1637	1282
360	37.0	1720	1792	1900	1487
390	37.4	1853	1931	2046	1602
420	37.8	1961	2043	2166	1696
450	38.2	2065	2151	2280	1785
480	38.7	2193	2284	2421	1896
510	39.1	2288	2383	2526	1978
540	39.5	2373	2472	2620	2051
600	40.3	2563	2670	2830	2216



LIGHT LED M08 CoB Product Series

4.3 Relative Spectral Power Distribution at Typical Current

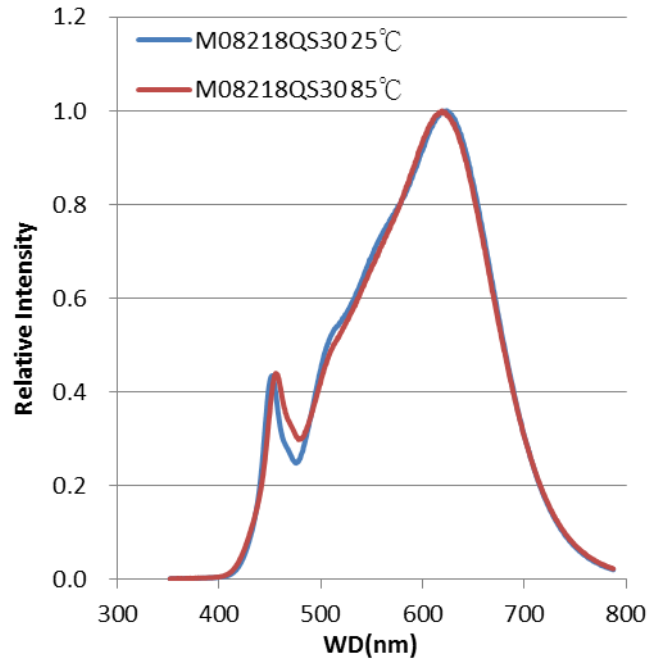
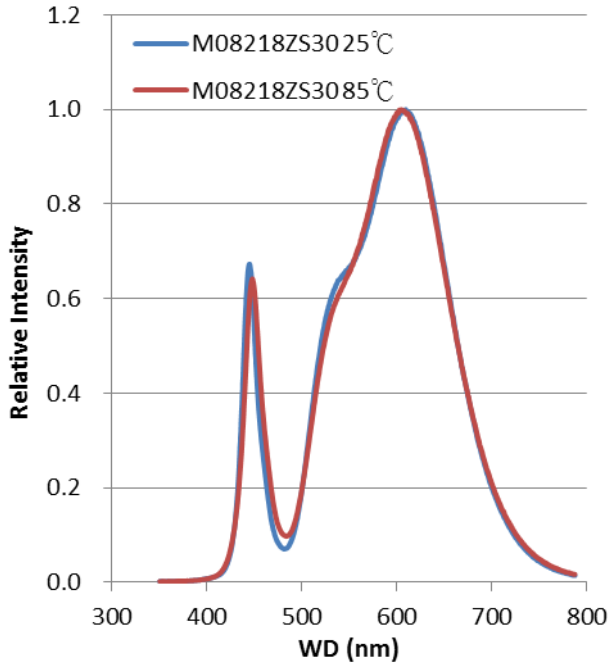

4.4 Radiation Characteristics



LIGHT LED M08 CoB Product Series

4.5 Forward Current vs. Forward Voltage

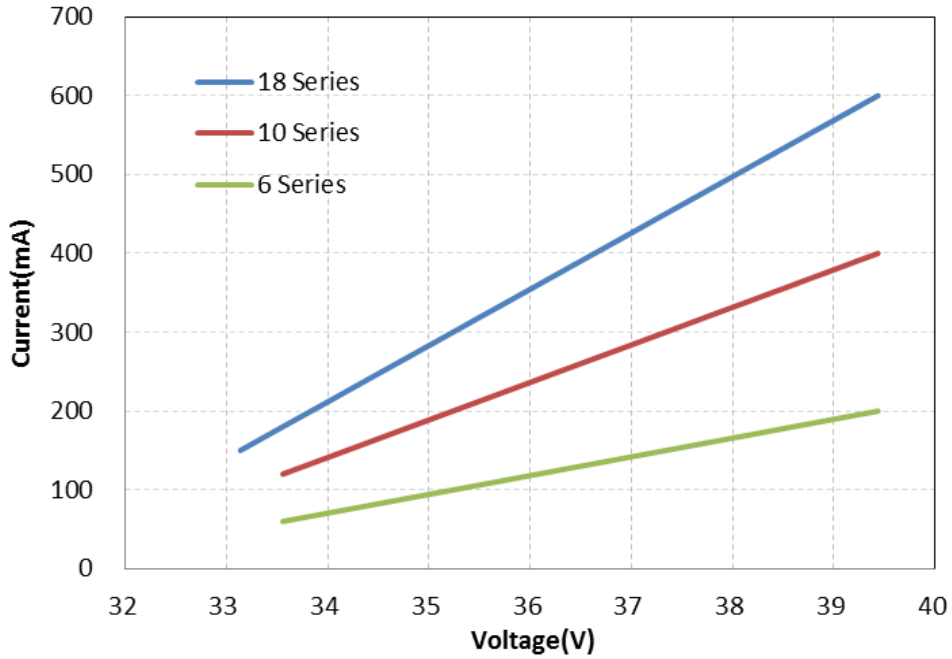

4.6 Forward Current Degrading Curve

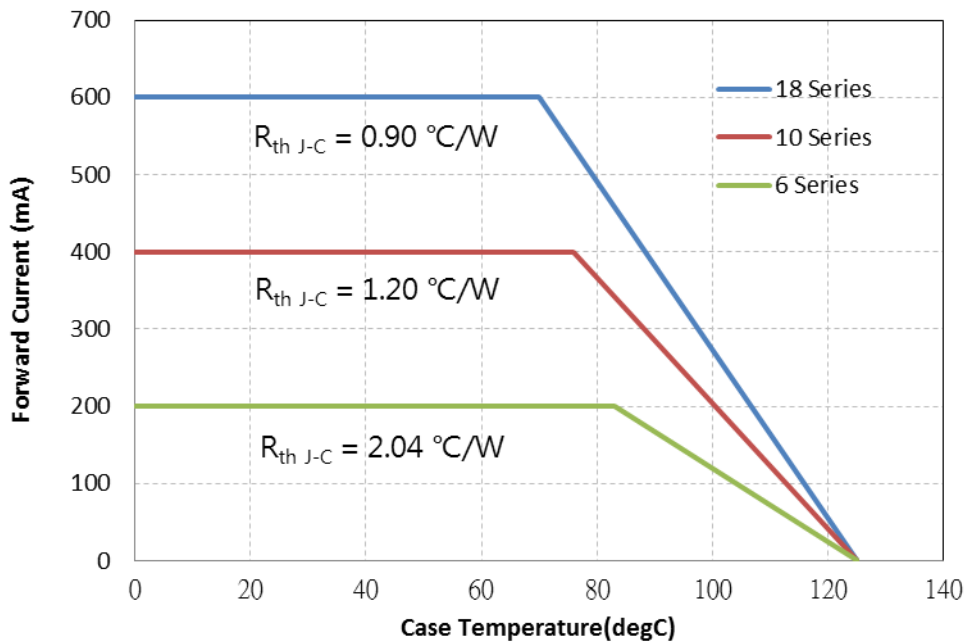

**LIGHT LED
M08 CoB Product Series**

4.7 Relative Intensity vs. Case Temperature

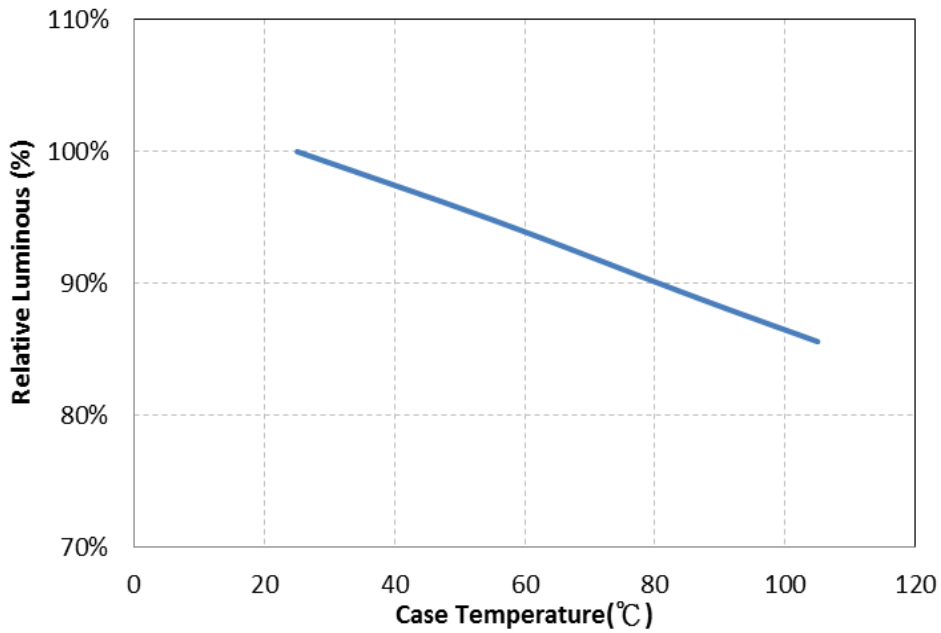

4.8 Forward Voltage vs. Case Temperature



LIGHT LED M08 CoB Product Series

5. CoB Binning Definition

Flux Binning Parameter (25degC)

Lumen CODE List of M08 Series Product			
Parameter	Code	Unit	Lumen
Luminous Flux	C	lm	495
	D		535
	E		580
	F		625
	G		675
	H		730
	I		790
	J		850
	K		920
	L		990
	M		1070
	N		1155
	O		1245
	P		1345
	Q		1455
	R		1570
	S		1695
	T		1830
	U		1975
	V		2130

Example of M08 Series Product Bin (2700K 06 series)

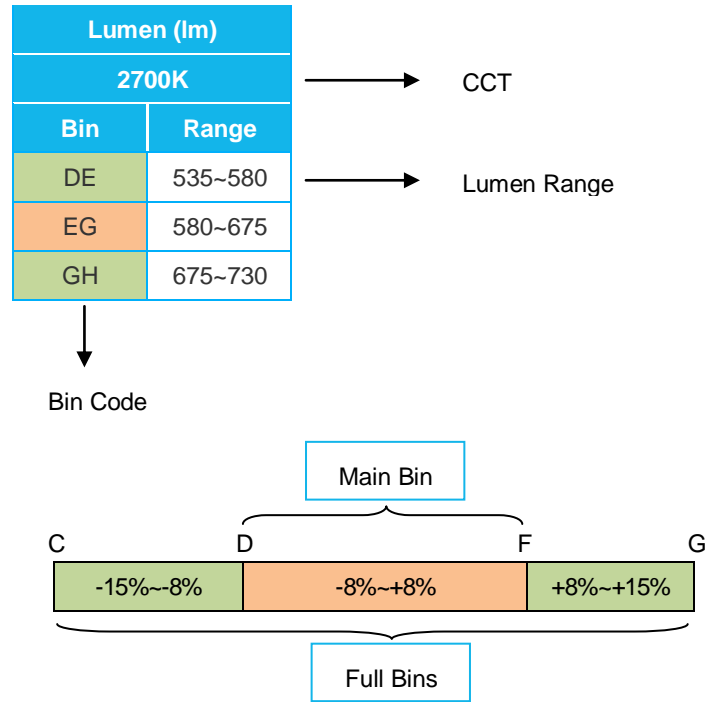

LIGHT LED M08 CoB Product Series

■ 06 Series Lumen Bin

Lumen (lm)							
CRI 80						CRI 90	
2700K		3000K		4000K		3000K	
Bin	Range	Bin	Range	Bin	Range	Bin	Range
DE	535~580	DE	535~580	EF	580~625	BC	460~495
EG	580~675	EG	580~675	FH	625~730	CE	495~580
GH	675~730	GH	675~730	HI	730~790	EF	580~625

■ 10 Series Lumen Bin

Lumen (lm)							
CRI 80						CRI 90	
2700K		3000K		4000K		3000K	
Bin	Range	Bin	Range	Bin	Range	Bin	Range
LM	990~1070	LM	990~1070	MN	1070~1155	JK	850~920
MO	1070~1245	MO	1070~1245	NP	1155~1345	KM	920~1070
OP	1245~1345	OP	1245~1345	PQ	1345~1455	MN	1070~1155

■ 18 Series Lumen Bin

Lumen (lm)							
CRI 80						CRI 90	
2700K		3000K		4000K		3000K	
Bin	Range	Bin	Range	Bin	Range	Bin	Range
QR	1455~1570	RS	1570~1695	RS	1570~1695	OP	1245~1345
RT	1570~1830	SU	1695~1975	SU	1695~1975	PR	1345~1570
TU	1830~1975	UV	1975~2130	UV	1975~2130	RS	1570~1695

LIGHT LED M08 CoB Product Series

■ Example of LiteOn CoB MacAdam Ellipse Color Definition (EX: 2700K)



CIE Center Point						
CCT	25degC (LiteOn Spec.)		85degC (ANSI)		Hot/Cold Factor	
	CCX	CCY	CCX	CCY	CCX	CCY
2700	0.4611	0.4137	0.4578	0.4101	-0.0033	-0.0036
3000	0.4381	0.4077	0.4338	0.4030	-0.0043	-0.0047
4000	0.3869	0.3860	0.3818	0.3797	-0.0051	-0.0063

Notes

1. LiteOn tester and shipping spec follow the color bin with 25degC CCX/CCY center.
2. The Hot/Cold factor means the CCX/CCY shift from 25degC to 85degC.
3. The Hot/Cold shift is measured by LiteOn CAS 140B instrument system.
4. The ellipse equation expression: $SDCM = (g11*(x-x_0)^2 + 2*g12*(x-x_0)*(y-y_0) + g22*(y-y_0)^2)^{0.5}$

LIGHT LED M08 CoB Product Series

■ M08 2700K

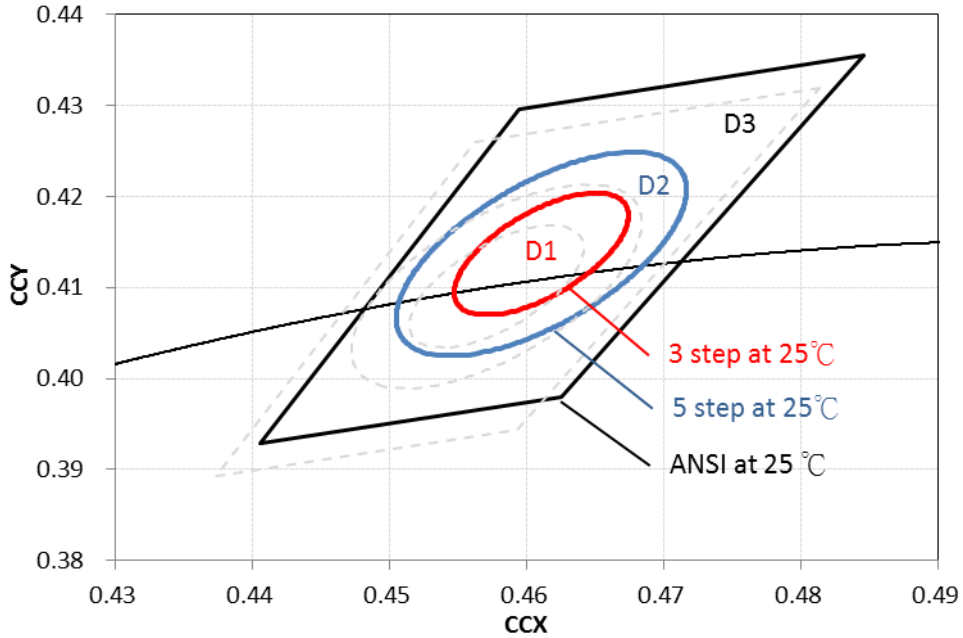

■ M08 3000K

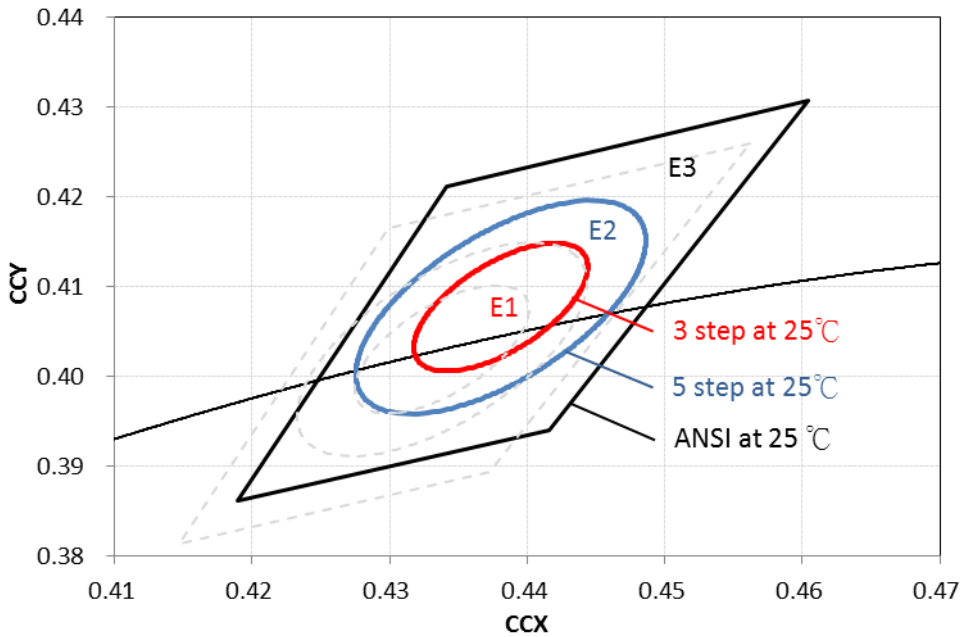

LIGHT LED M08 CoB Product Series

■ M08 4000K

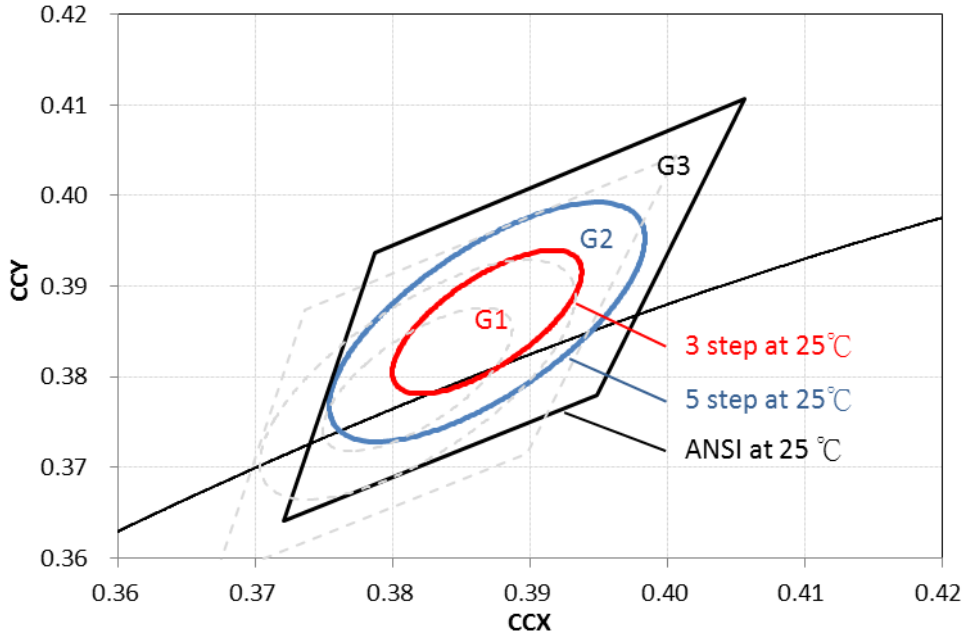

■ Forward Voltage Binning Parameter (25degC)

Parameter	Bin	Symbol	Min	Max	Unit	Condition
Forward Voltage	V1	V _F	33	42.0	V	I _F = Typical Current

Note:

1. Full Rank on Label. (Example: V1/EG/D1)

Forward Voltage Rank	Luminous Flux Rank	Color Rank
V1	EG	D1

LIGHT LED M08 CoB Product Series

6. Reliability Test Plan

No	Test item	Condition	Duration	Result
1	High Temperature Operating Life	Tc=85°C, IF=Typical Current	1K hours	Pass
2	Wet High Temperature Operating Life	60°C/90%RH, IF=Typical Current(DC) 30 min ON/OFF	1K hours	Pass
3	Thermal Shock	-40°C to 125°C, 15minutes dwell, <10 seconds transfer, measurement in every 250 cycle	500 cycles	Pass
4	Fast Switch Cycling Test	40000cycles, 2 mins On/Off, Room temperature(25°C+/-5C), measurement in every 5000 cycle	40K cycles	Pass
5	High Temperature Storage Life	Ta=120°C	1K hours	Pass
6	Low Temperature Storage Life	Ta=-55°C	1K hours	Pass
7	Mechanical Shock	1500G, 0.5ms pulse, 5 shocks each 6 axis	30 Times (5 shocks each 6 axis)	Pass
8	Variable Vibration Frequency	10-2000-10 Hz, log or linear sweep rate, 20G for approximately minute 1.5mm, each applied three times per axis over 6 hrs.	18 hrs (three times per axis over 6 hrs.)	Pass

Criteria for Judging the Damage

Item	Symbol	Test Condition	Criteria for Judgment	
			Min.	Max.
Forward Voltage	Vf	IF=Typical Current		U.S.L. x 1.1
Luminous Flux	Lm	IF=Typical Current	L.S.L. x 0.7	
CCX&CCY	X,Y	IF=Typical Current		Shift<0.02

Notes:

1. Operating life test are mounted on thermal heat sink
2. Storage item are only component, not put on heat sink.

**LIGHT LED
M08 CoB Product Series**

7. Packing Specifications

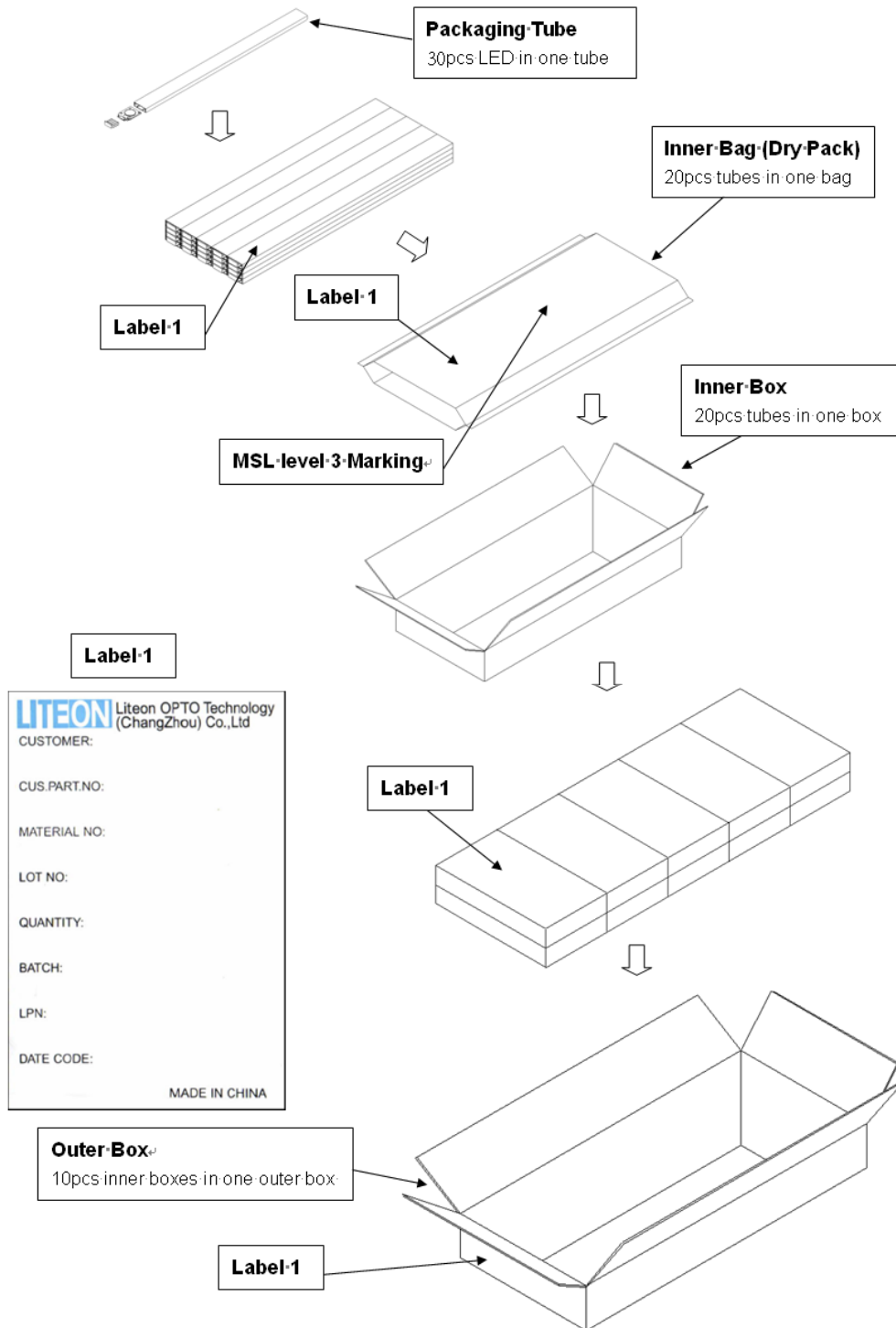

LIGHT LED M08 CoB Product Series

8. Cautions

8.1 An LED is a current-operated device. In order to ensure intensity uniformity on multiple LEDs connected in parallel in an application, it is recommended that a current limiting resistor be incorporated in the drive circuit, in series with each LED as shown in circuit below.

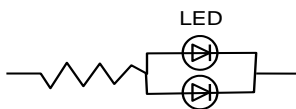

(A) Recommended circuit.

(B) The brightness of each LED might appear different due to the differences in the I-V characteristics of those LEDs.

8.2 Do not put any pressure on the light emitting surface either by finger or any hand tool and do not stack the COB products. Stress or pressure may cause damage to the wires of the LED array.

8.3 This product is not designed for the use under any of the following conditions, please confirm the performance and reliability are well enough if you use it under any of the following conditions

- Do not use sulfur-containing materials in commercial products including the materials such as seals and adhesives that may contain sulfur.
- Do not put this product in a place with a lot of moisture (over 85% relative humidity), dew condensation, briny air, and corrosive gas (Cl, H₂S, NH₃, SO₂, NOX, etc.), exposure to a corrosive environment may affect silver plating.

ESD (Electrostatic Discharge)

Static Electricity or power surge will damage the LED. Suggestions to prevent ESD damage:

- Use of a conductive wrist band or anti-electrostatic glove when handling these LEDs.
- All devices, equipment, and machinery must be properly grounded.
- Work tables, storage racks, etc. should be properly grounded.
- Use ion blower to neutralize the static charge which might have built up on surface of the LED's plastic lens as a result of friction between LEDs during storage and handling.

ESD-damaged LEDs will exhibit abnormal characteristics such as high reverse leakage current, low forward voltage, or "no light up" at low currents.

To verify for ESD damage, check for "light up" and V_F of the suspect LEDs at low currents.