

## CARMEN-RS-C-WHT

~10° spot beam. Assembly with holder C compatible with HEKLA sockets and connectors. White version.

### TECHNICAL SPECIFICATIONS:

Dimensions	Ø 69.5 mm
Height	41.5 mm
Fastening	socket
ROHS compliant	yes ⓘ

### MATERIAL SPECIFICATIONS:

Component	Type	Material	Colour	Finish
CARMEN-RS	Single lens	PMMA	clear	
CARMEN-HLD-C-WHT	Holder	PC	white	





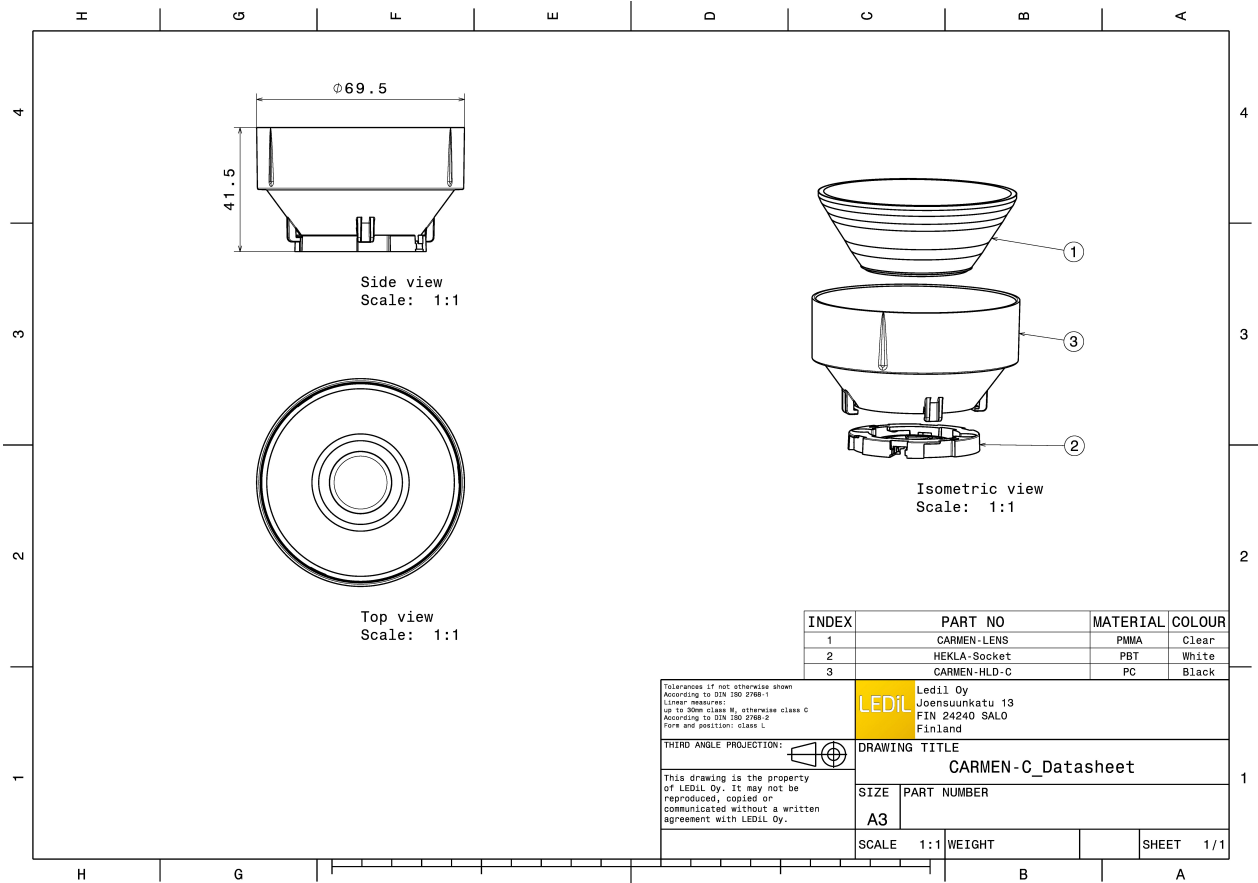

### ORDERING INFORMATION:

Component		Qty in box	MOQ	MPQ	Box weight (kg)
CP16940_CARMEN-RS-C-WHT	Single lens	150	150	15	8.8
» Box size: 480 x 280 x 300 mm					

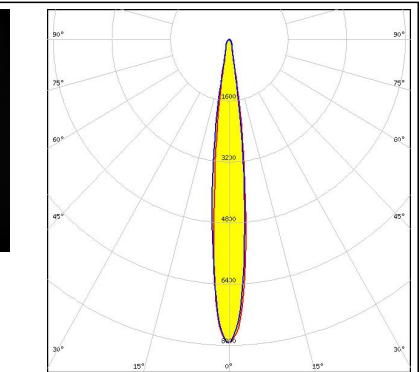
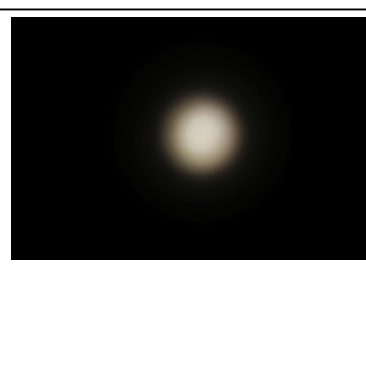
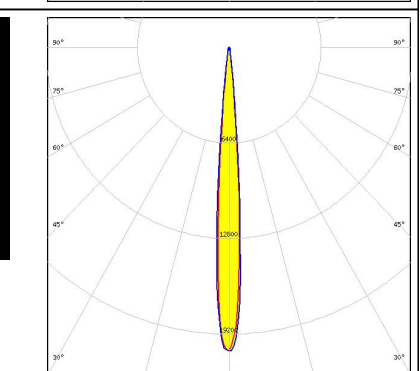

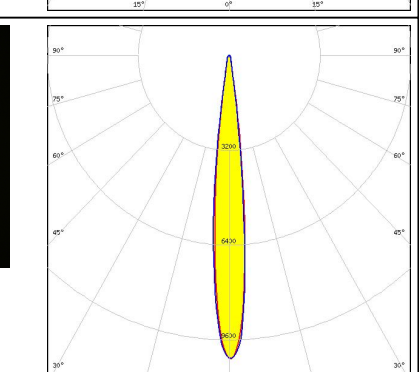
#### PHOTOMETRIC DATA (MEASURED):

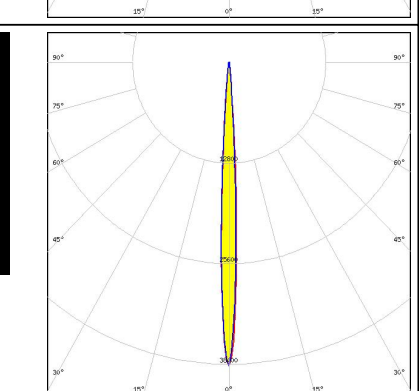
<p>bridgelux</p> <p>LED Vesta TW 9mm (9W) DP            FWHM 12.0°            Efficiency 83 %            Peak intensity 7.9 cd/lm            LEDs/each optic 1            Light colour White            Required components:            C16142_HEKLA-SOCKET-K            Bender Wirth: 489 Typ L8</p>		
<p><b>CITIZEN</b></p> <p>LED CLU700/701/702            FWHM 8.0°            Efficiency 86 %            Peak intensity 20.4 cd/lm            LEDs/each optic 1            Light colour White            Required components:            F15255_HEKLA-SOCKET-C</p>		
<p><b>CITIZEN</b></p> <p>LED CLU710/711            FWHM 12.0°            Efficiency 83 %            Peak intensity 10.3 cd/lm            LEDs/each optic 1            Light colour White            Required components:            F15859_HEKLA-SOCKET-I</p>		
<p><b>CITIZEN</b></p> <p>LED CLU7B2            FWHM 6.0°            Efficiency 87 %            Peak intensity 38.6 cd/lm            LEDs/each optic 1            Light colour White            Required components:            F15255_HEKLA-SOCKET-C</p>		

#### PHOTOMETRIC DATA (MEASURED):



LED CXA/B 15xx  
 FWHM 12.0°  
 Efficiency 85 %  
 Peak intensity 10.8 cd/lm  
 LEDs/each optic 1  
 Light colour White  
 Required components:  
 F15256\_HEKLA-SOCKET-D

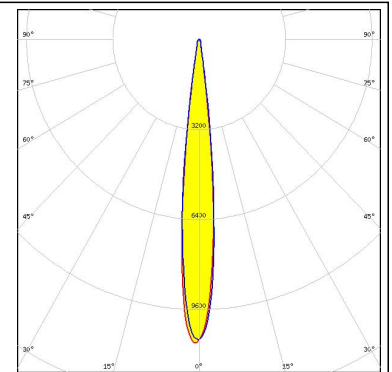

LED LUXEON CX Plus CoB - HD S01H4  
 FWHM 8.0°  
 Efficiency 87 %  
 Peak intensity 27.2 cd/lm  
 LEDs/each optic 1  
 Light colour White  
 Required components:  
 Bender Wirth: 634c Lena

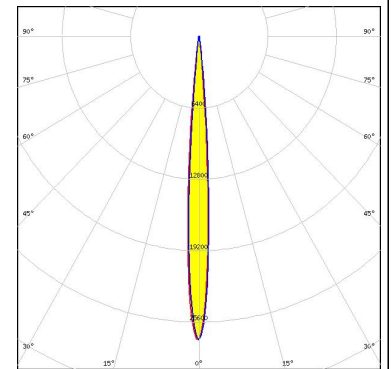

LED LUXEON CX Plus CoB - HD S04H9  
 FWHM 13.0°  
 Efficiency 86 %  
 Peak intensity 10.5 cd/lm  
 LEDs/each optic 1  
 Light colour White  
 Required components:  
 Bender Wirth: 634c Hekla

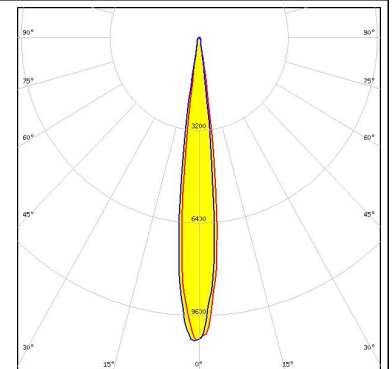
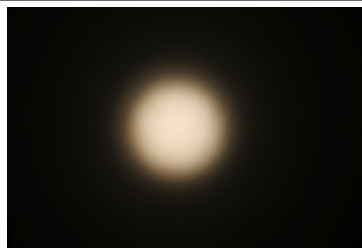

LED CXM-3  
 FWHM 6.0°  
 Efficiency 88 %  
 Peak intensity 36.9 cd/lm  
 LEDs/each optic 1  
 Light colour White  
 Required components:  
 F15255\_HEKLA-SOCKET-C

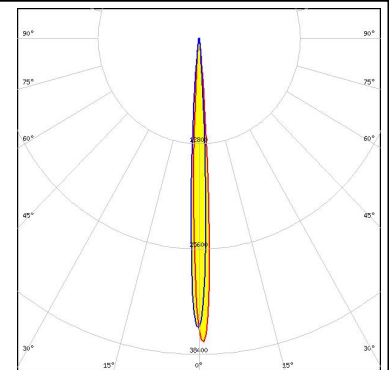

#### PHOTOMETRIC DATA (MEASURED):



LED CXM-4  
 FWHM 7.0°  
 Efficiency 86 %  
 Peak intensity 27.1 cd/lm  
 LEDs/each optic 1  
 Light colour White  
 Required components:  
 F15255\_HEKLA-SOCKET-C

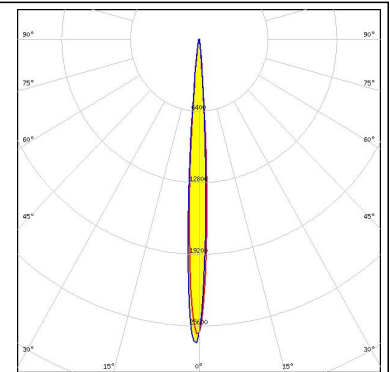

LED LC020C  
 FWHM 11.0°  
 Efficiency 84 %  
 Peak intensity 13 cd/lm  
 LEDs/each optic 1  
 Light colour White  
 Required components:  
 F15848\_HEKLA-SOCKET-G

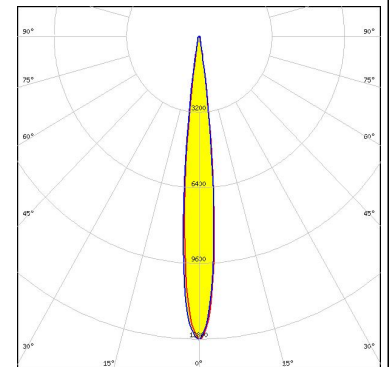
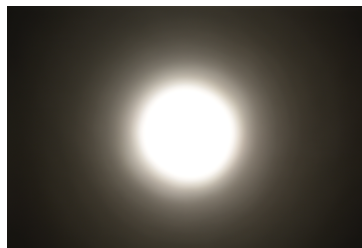

LED XOB 6 mm  
 FWHM 9.0°  
 Efficiency 83 %  
 Peak intensity 20.1 cd/lm  
 LEDs/each optic 1  
 Light colour White  
 Required components:  
 F15255\_HEKLA-SOCKET-C

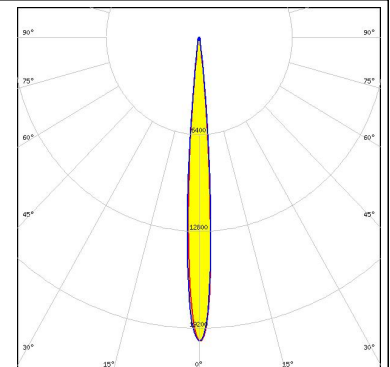
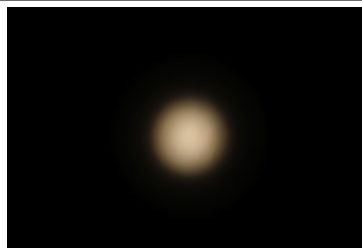

LED XOB 9.8 mm  
 FWHM 12.0°  
 Efficiency 85 %  
 Peak intensity 10.3 cd/lm  
 LEDs/each optic 1  
 Light colour White  
 Required components:  
 F15255\_HEKLA-SOCKET-C

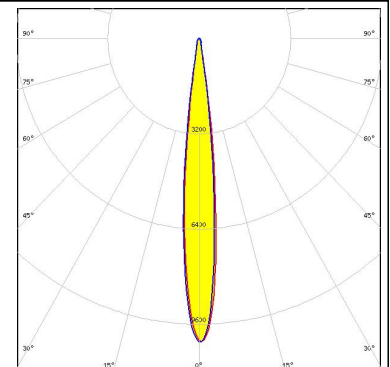
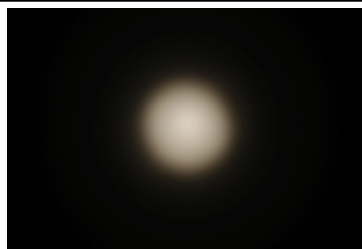

#### PHOTOMETRIC DATA (SIMULATED):

#### CITIZEN

LED CLL02x/CLU02x (LES10)  
FWHM 14.0°  
Efficiency 90 %  
Peak intensity 10.4 cd/lm  
LEDs/each optic 1  
Light colour White  
Required components:  
F15255\_HEKLA-SOCKET-C

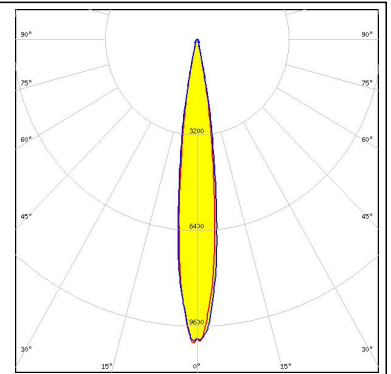

#### GENERAL INFORMATION:

NOTE: The typical beam angle will be changed by different color, chip size and chip position tolerance. The typical total beam angle is the full angle measured where the luminous intensity is half of the peak value.

Due to use of high power COB's with this product, special attention to proper thermal design is highly recommended. LEDiL has no liability for direct, indirect or consecutive damages arising from the LEDiL products being used outside of the recommended temperature range.

#### MATERIALS:

As part of our continuous research and improvement processes, and to ensure the best possible quality and availability of our products, LEDiL reserves the right to change material grades without notice.

#### PRODUCT DATA USER AGREEMENT AND DISCLAIMER:

The measured data in the provided downloadable LEDiL Product Datasheets and Mechanical 2D-Drawings is rounded and provided as reference for planning. LEDiL Oy's optical specifications have been verified by conducting performance testing of the products in accordance with the company's quality system. The reported data are averaged results of multiple measurements with typical variation. LEDiL Oy reserves the right to without prior notification make changes and improvements to its products.

LEDiL Oy assumes neither warranty, nor guarantee nor any other liability of any kind for the contents and correctness of the provided data. The provided data has been generated with highest diligence but the provided data may in reality not represent the complete possible variation range of all intrinsic parameters. Therefore, in certain cases a deviation from the provided data could occur.

LEDiL Oy reserves the right to undertake technical changes of its products without further notification which could lead to changes in the provided data. LEDiL Oy assumes no liability of any kind for the possible deviation from any provided data or any other damage resulting from the usage of the provided data.

The user agrees to this disclaimer and user agreement with the download or usage of the provided files.

#### LEDiL Oy

Joensuunkatu 13  
FI-24240 SALO  
Finland

#### LEDiL Inc.

228 West Page Street  
Suite D  
Sycamore IL 60178  
USA

#### Local sales and technical support

[www.ledil.com/where\\_to\\_buy](http://www.ledil.com/where_to_buy)

#### Shipping locations

Salo, Finland  
Hong Kong, China

#### Distribution Partners

[www.ledil.com/where\\_to\\_buy](http://www.ledil.com/where_to_buy)