

SD4Y Programmer

Programmer Introduction Programming Procedure for the AMS AS5xxx Series

Table of Contents

Table of Contents	2
1 Introduction	4
2 Main Features	5
3 Supported Devices:.....	5
4 SD4Y Programmer operation conditions UPROG1.4	6
4.1 Outputs.....	6
4.2 Inputs	6
4.3 Absolute maximum ratings Inputs.....	7
4.4 ESD Protection and Operating Temperature	7
5 Programmer Hardware Description	8
5.1 SD4Y Programmer Hardware Description	8
5.2 Additional Hardware.....	11
5.2.1 Standard Adapter for 1 Wire Interface / SPI Interface and I2C Interface	11
5.2.2 Relay Board	12
6 SD4Y Programmer GUI Installation	13
7 Programming of the ams AS5xxx series.....	14
7.1 ams AS5145.....	14
7.1.1 Hardware.....	14
7.1.2 Programming Procedure and Function Description for the ams AS5145.....	15
7.2 ams AS5045B	20
7.2.1 Hardware.....	20
7.2.2 Programming Procedure and Function Description for the ams AS5045B	21
7.3 ams AS5043.....	26
7.3.1 Hardware.....	26
7.3.2 Programming Procedure and Function Description for the ams AS5043.....	27
7.4 ams AS5045.....	32
7.4.1 Hardware.....	32
7.4.2 Programming Procedure and Function Description for the ams AS5045.....	33
7.5 ams AS5140.....	38
7.5.1 Hardware.....	38
7.5.2 Programming Procedure and Function Description for the ams AS5140.....	39
7.6 ams AS5040.....	44

UPROG Programmer - Programming Procedure for ams AS5xxx series

7.6.1	Hardware.....	44
7.6.2	Programming Procedure and Function Description for the ams AS5040.....	45
7.7	ams AS5030.....	50
7.7.1	Hardware.....	50
7.7.2	Programming Procedure and Function Description for the ams AS5030.....	51
7.8	ams AS5134.....	56
7.8.1	Hardware.....	56
7.8.2	Programming Procedure and Function Description for the ams AS5134.....	57
7.9	ams AS5132.....	62
7.9.1	Hardware.....	62
7.9.2	Programming Procedure and Function Description for the ams AS5030.....	63
8	Programming of the ams 1 Wire UART Sensors.....	67
8.1	AS5x6y programming procedure.....	67
8.2	AS5403 programming procedure.....	67
9	Programming of the ams Sensors with standard interfaces.....	68
9.1	ams AS5147.....	68
9.1.1	Hardware.....	68
9.1.2	Programming Procedure and Function Description for the ams AS5147.....	69
9.2	ams AS5047D.....	73
9.2.1	Hardware.....	73
9.2.2	Programming Procedure and Function Description for the ams AS5147.....	74
	Copyright.....	78
	Disclaimer.....	78

UPROG Programmer - Programming Procedure for ams AS5xxx series

Revision History

Revision	Date	Owner	Description
1.0	22-5-2013	SD4Y	Initial doc
1.1	18-08-2013	SD4Y	ams AS5030 update
1.2	18-09-2013	SD4Y	ams AS5132 update
1.3	24-10-2013	SD4Y	ams AS5134; ams 5045B update
1.4	06-11-2013	SD4Y	Introduction update
1.5	06-11-2013	SD4Y	ams AS5043; ams5045; ams5140;
1.6	06-02-2014	SD4Y	Adding operation conditions
1.7	12-09-2014	SD4Y	Including AS5162 and AS5403; additional HW
1.8	28-01-2015	SD4Y	updated limits for fuses

1 Introduction

The SD4Y production programmer is designed for high-speed programming for the AMS magnetic position sensors in the production.

The programmer supports all interfaces for programming the AS5x4x, AS5x3x and AS514x magnetic position sensor.

All mandatory commands e.g. Analog Read back, which are necessary and mandatory for programming the AMS magnetic position sensors, are implemented.

The SD4Y is fully ESD protected and the power supply is galvanic isolated from the internal uC.

Internal Voltage measurements are checking the supply and programming voltage to be sure, there is no internal damage.

The SD4Y production programmer is operating in standalone mode.

UPROG Programmer - Programming Procedure for ams AS5xxx series

2 Main Features

- Supports AMS magnetic position sensors, with required programming voltage
- High speed programming
- Analog read back of AMS OTP technology supported
- Fully ESD and Over-voltage protected I/O (galvanic isolation)
- Internal diagnostics
- Supply and IO voltage adjustable
- Detection of load condition and automatic speed adaption feature
- USB Connector
- Serial Connector
- Included Programming Capacitors
- Automatically disconnecting of the programming capacitors during analog read back

3 Supported Devices:

The following list is showing the AMS magnetic position sensors, which are integrated in the programmer uC & GUI. Drivers are available for LabView 2010 32bit and 32 bit Windows dll.

AS5030
AS5040
AS5043
AS5045
AS5045B
AS5047D
AS5115
AS5132
AS5134
AS5140
AS5145
AS5147

The following devices are supported by hardware & drivers. GUI is provided by ams.

AS5x6y Family
AS5403

UPROG Programmer - Programming Procedure for ams AS5xxx series

4 SD4Y Programmer operation conditions UPROG1.4

4.1 Outputs

Parameter	Min	Typ.	Max	Units	Comments
Digital outputs in 3,3V mode	3	3.3	3.6	V	2mA load
VDD in 3,3V mode	3	3.3	3.6	V	
Digital outputs in 5V mode	4.5	5	5.5	V	2mA load
VDD in 5V mode	4.5	5	5.5	V	
Prog PIN	3	n.a.	8.6	V	
I _{max} VDD _{usb}	50	n.a.	n.a.	mA	USB Supply
I _{max} VDD _{RS232}	150	n.a.	n.a.	mA	RS232 Supply external
I _{max} V _{Prog}	50	n.a.	n.a.	mA	
I _{max} on digital IO	20	n.a.	n.a.	mA	1 channel, short circuit

4.2 Inputs

Parameter	Min	Typ.	Max	Units	Comments
VDD _{USB}	4.5	5	5.5	V	
VDD _{RS232}	11	12	13	V	
Digital I/O in 3.3V mode	3	3,3	3,6	V	
Digital I/O in 5V mode	4.5	5	5.5	V	
Analog input voltage on Prog	0	n.a.	3.3	V	

UPROG Programmer - Programming Procedure for ams AS5xxx series

4.3 Absolute maximum ratings Inputs

Parameter	Min	Typ.	Max	Units	Comments
High Level Input	n.a.	n.a.	7	V	Digital pins
Low Level Input	-0.4	n.a.	n.a.	V	Digital pins
High Level Input	n.a.	n.a.	5	V	Analoque pins
Low Level Input	-0.4	n.a.	n.a.	V	Analoque pins

4.4 ESD Protection and Operating Temperature

Parameter	Min	Typ.	Max	Units	Comments
Human Body Model	2000			V	On any Pin (prog connector)
Machine Model	200			V	On any Pin (prog connector)
Charge-Device Model	1000			V	On any Pin (prog connector)
Parameter	Min	Typ.	Max	Units	Comments
Operating Temperature	10	25	35	[degC]	

UPROG Programmer - Programming Procedure for ams AS5xxx series

5 Programmer Hardware Description

5.1 SD4Y Programmer Hardware Description

The SD4Y Programmer has two possible input connectors for the PC

- 1) USB
- 2) RS232 and external Power Supply (**12V max**)

USB:

The USB connector can be used for operate the SD4Y Programmer without an additional Supply.

Important: The max allowed current consumption on the VDD is 50mA. Otherwise the USB controller turns off.

A firmware upgrade is only possible with the USB connector.

RS232:

To use the RS232 an additional Supply is necessary. **The max. Voltage is 12V.**

Important: The max allowed current consumption on the VDD is 150mA. Otherwise the RS232 controller turns off.

UPROG Programmer - Programming Procedure for ams AS5xxx series

SD4Y-Programmer Connector

The SD4Y Programmer has a 20 pin connector for the DUT (Device under test)

This Connector has the same PIN Out like the AMS AS5000 Programmer.

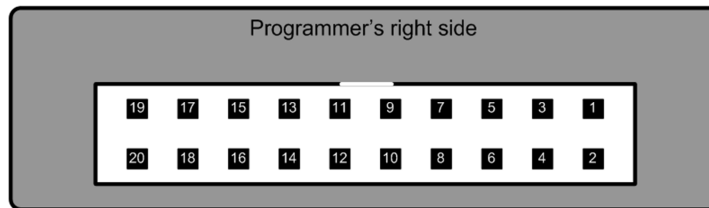

Pin #	Signal	Comment
1	Vzap	Programming voltage
2	Vzap	Programming voltage
3	D10	Encoder signal
4	ADC2	Device autodetection voltage
5	D9	Encoder signal
6	ADC1	Vzap feedback
7	D8	Encoder signal
8	D11	Encoder signal
9	D7	Encoder signal
10	D6	Encoder signal
11	VDD	Encoder power supply
12	VDD	Encoder power supply
13	GND	Ground
14	GND	Ground
15	D5	Encoder signal
16	D0	Encoder & LCD display signal
17	D4	Encoder signal
18	D1	LCD signal – Do not use
19	D3	Encoder signal
20	D2	Encoder signal

UPROG Programmer - Programming Procedure for ams AS5xxx series

Connection of the SD4Y Programmer to an AMS Sensor during programming and analog readback mode

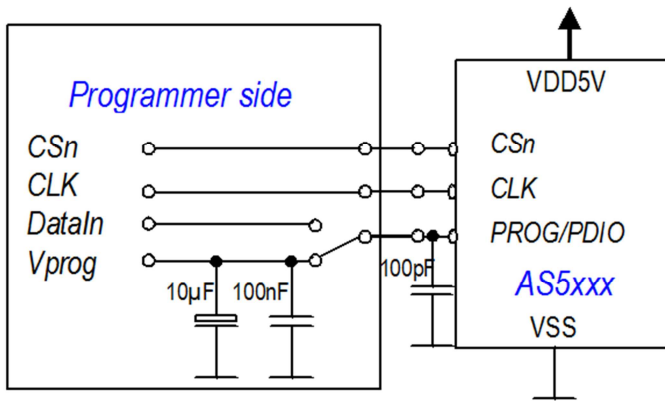

Programming: During programming the programmer is switching internal the programming caps to the Programming Pin.

Additional Programming Capacitors are not necessary and not allowed. The max allowed capacitor on the Programming Pin on the Application board is 100pF.

The cable length has to be as short as possible.

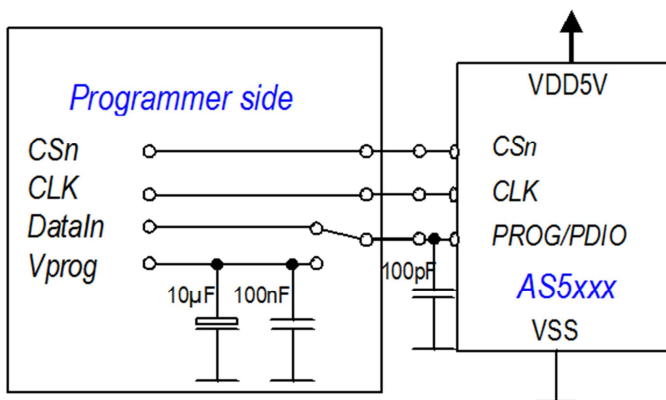

AnalogReadBack: During the analog read back, programmer is disconnecting automatically the internal programming capacitors

The max allowed capacitor on the Programming Pin on the Application board is 100pF during analog read back. Otherwise the not fused fuses can be destroyed.

The cable length has to be as short as possible.

5.2 Additional Hardware

5.2.1 Standard Adapter for 1 Wire Interface / SPI Interface and I2C Interface

The standard adapter is necessary for AMS Sensors with 1-Wire UART (e.g. AS5162 or AS5403) and AMS Sensors with a standard SPI Interface. Additional there is the possibility to use this adapter board for AMS Sensor with I2C Interface.

Additional for the AS5403 there is a PWM_Sync Input included for triggered SPI or UART Read.

Board:

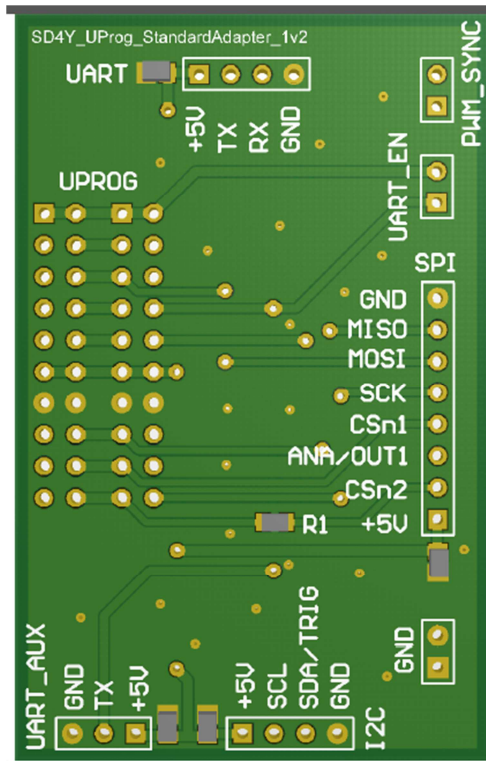

UPROG Programmer - Programming Procedure for ams AS5xxx series

5.2.2 Relay Board

The Relay Board is for the following sensors and measurements necessary.

- 1) AS5262 Sensor: With this relay board there is the possibility to program both dies with one programmer
- 2) Using External VDD.
- 3) Using a DVM to measure the right DAC Value of the AS5262 --> DAC Calibration

Board:

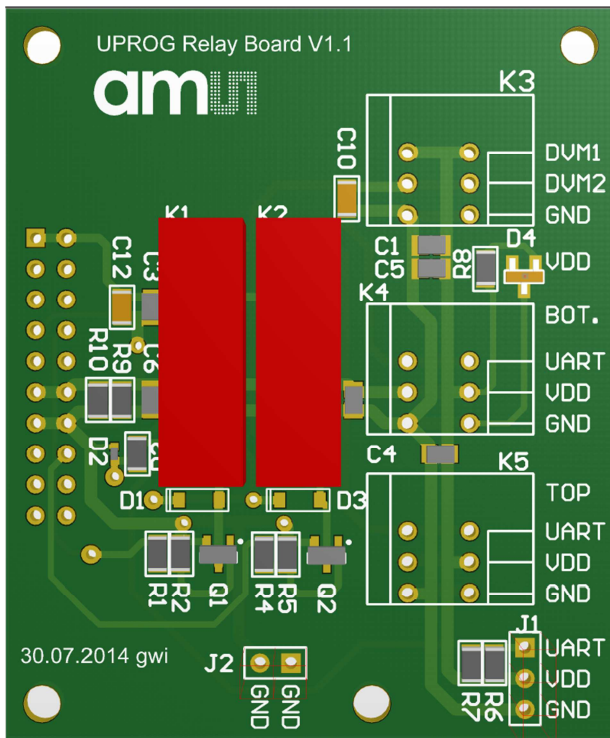

6 SD4Y Programmer GUI Installation

To use the SD4Y Programmer GUI some additional steps are necessary to run the software.

- 1) Download the latest Labview Runtime Engine and VISA Drivers
The GUI is written in Labview. For this reason the latest Labview Runtime Engine (Labview Runtime Engine 2012) and the latest VISA Drivers(NI-VISA Runtime Engine) are necessary. Please find the files on the official National Instruments webpage www.ni.com
- 2) Install the GUI for the SD4Y Programmer
- 3) Connect the USB or the RS232 to the Programmer and the PC. It's not allowed to use both connections at the same time.
- 4) The connection to the DUT has to be open during the first GUI start up. If the GUI is running and the right device is used it's not necessary to disconnect the Programmer Connector
- 5) Open the GUI

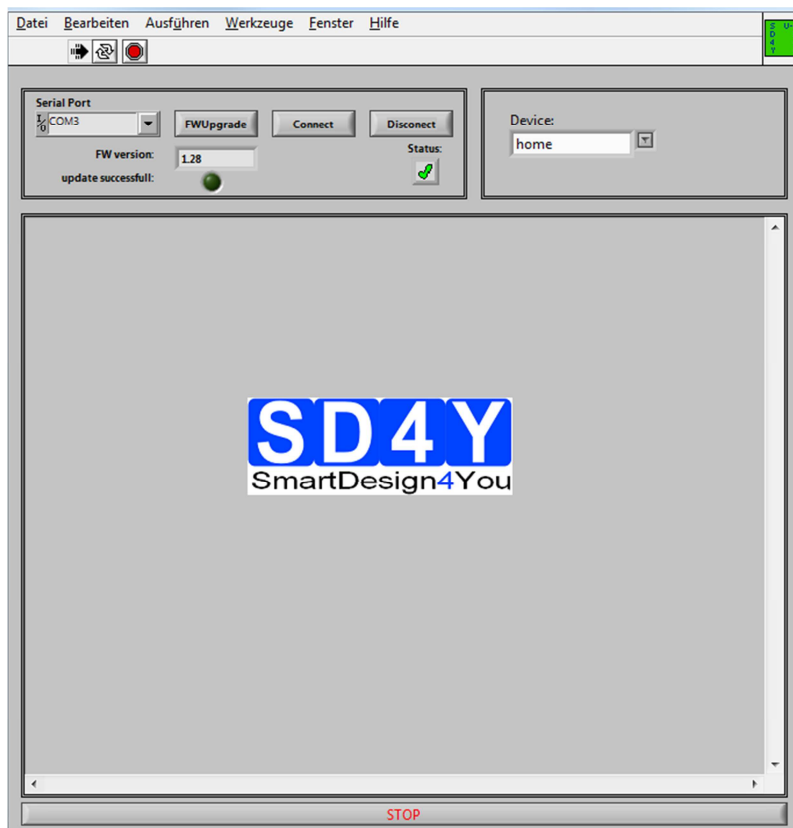

7 Programming of the ams AS5xxx series

7.1 ams AS5145

7.1.1 Hardware

PINOUT: 20 PIN Connector to AS5145/AS5045

Connector on the SD4Y Programmer

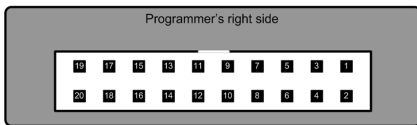

Pinout AS5145

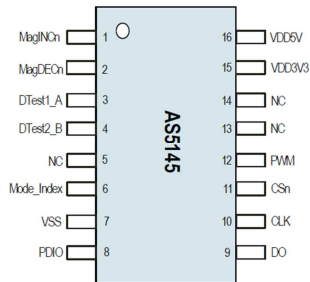

*copyright by ams 2013

Connection between SD4Y and AS5145

SD4Y Connector	AS5145
PinNr	PinDescription
1	Vprog
2	Vprog
13	GND
14	GND
11	Vdd
12	Vdd
15	DO
17	CSn
20	CLK

7.1.2 Programming Procedure and Function Description for the ams AS5145

1) Start the GUI

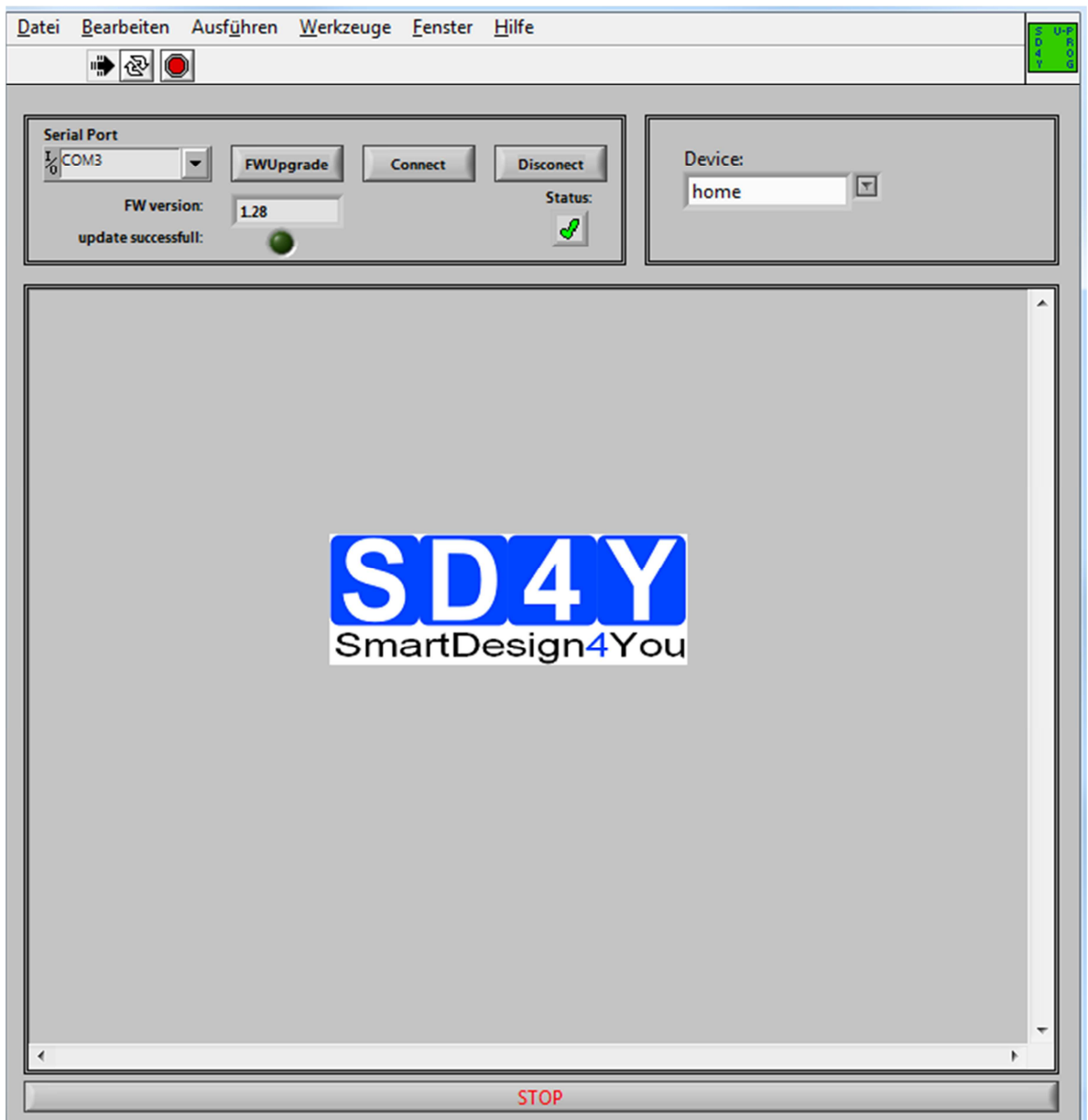

a) Choose the right COM Port



UPROG Programmer - Programming Procedure for ams AS5xxx series



- b) Press the  Button. The Status will change to the green checkmark.
- c) Please check if the latest firmware is used. For a firmware update, please connect the programmer to the USB , choose the right COM and press the FW upgrade

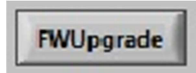

Button

If the update was successful, the FW- Version will change.

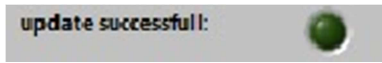

Additional the  marker will be green.



- 2) Choose the right Device  (AS5145)
- 3) The GUI will change to the right Device

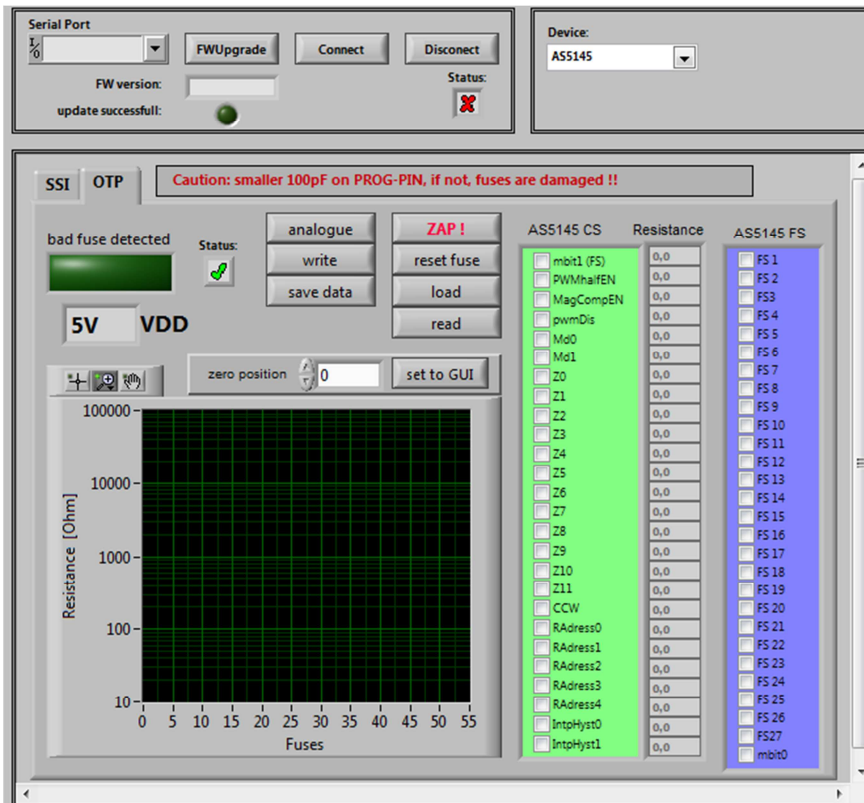

- 4) Set the VDD to the right Value
- 5) To use the **OTP TAB Area** first is important.

UPROG Programmer - Programming Procedure for ams AS5xxx series

6) SSI Tab : If a zero programming is necessary.

By selecting the SSI tab, information of the angular position and the status bits appear:

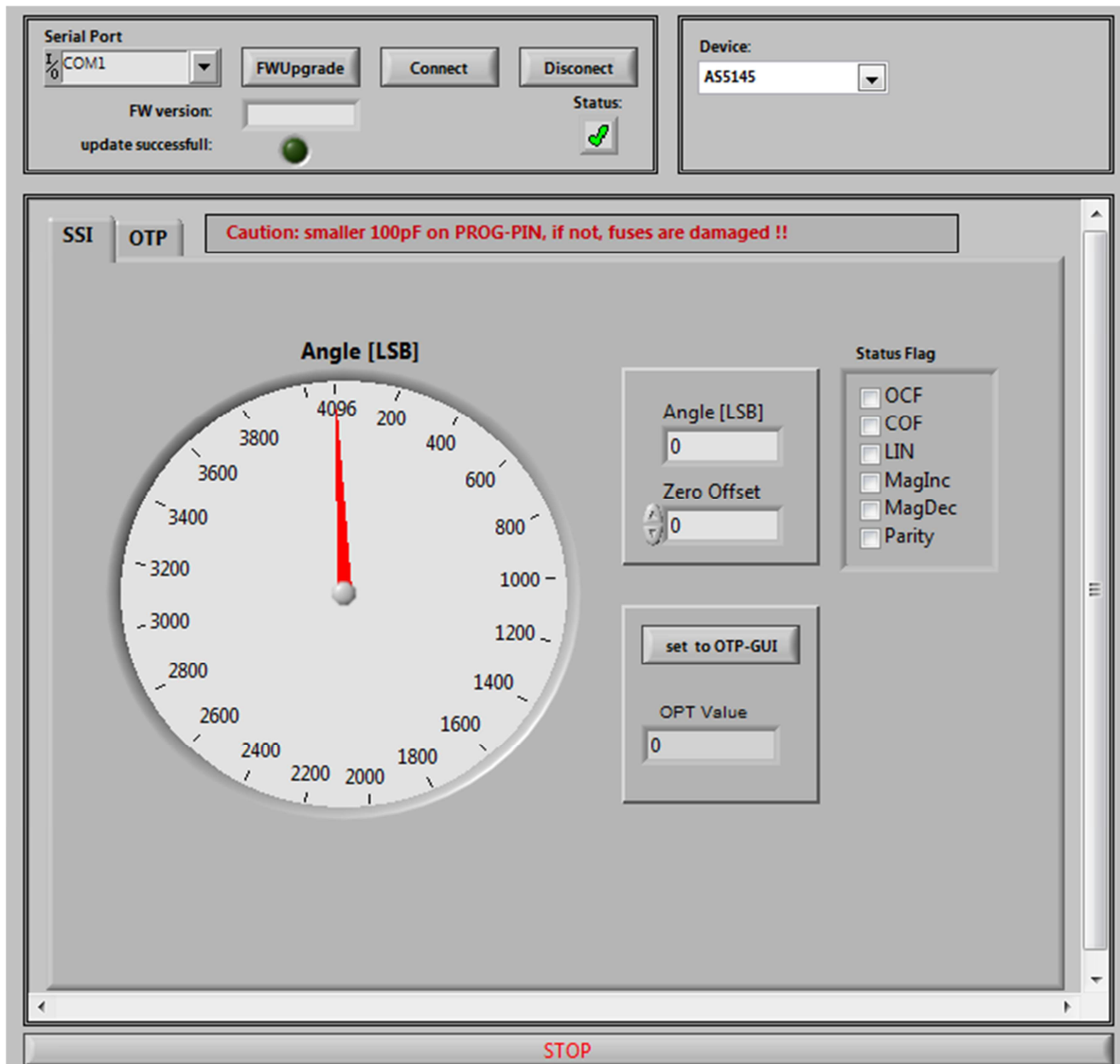

- Angle [LSB] Graphic is showing the actual position of the magnet.
- Angle [LSB] is showing the actual position of the magnet in LSB
- Zero Offset: For adding or subtracting an offset to the current Angle position
- Set to OTP-GUI: The OPT Value is showing the Angle + the zero offset. With pushing the "Set to OTP-GUI" button the information of the OPT Value is stored in the AS5145CS area of the OTP Tab.

UPROG Programmer - Programming Procedure for ams AS5xxx series

- Status flag: The Status Flag displays the status bits extracted from the SSI.

- 7) Push the “set to OTP-GUI” for setting the zero point or use the manual setting of the zero



point in the OTP Tab area.

- 8) **Change to the OTP Area.**

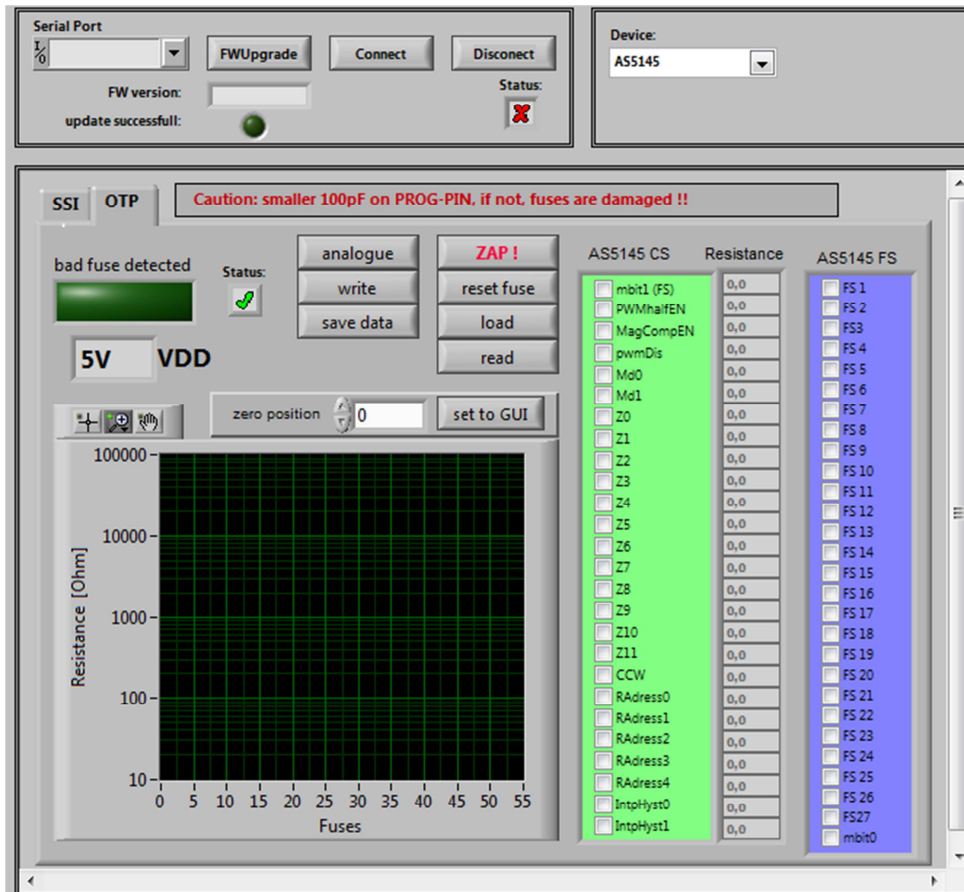

- 9) Select necessary Bits for programming in the **AS5145 CS** (Customer settings)

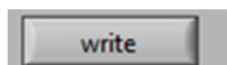

- 10) Push the write button

- 11) The OTP Write was successful.

UPROG Programmer - Programming Procedure for ams AS5xxx series

12) Several writing is possible.

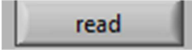
13) Push the read button  if a digital reading is necessary

14) Several digital reading is possible.

15) If the values in the AS5145 CS area are right, push  Button for permanent programming.

16) **Push Analogue. The analog read back is mandatory, after programming!**

Warning: It's not allowed to connect a capacitor to the VPRog. This can destroy all OTP Bits during the analog read back

17) In the "Resistance" area is the OTP Fuse resistance Information of all Customer Bits.

Programmed Fuse: 50 - 200 Ohm

Unprogrammed Fuse: >10 kOhm

Bad Fuse: 200 Ohm - 10 kOhm

If a bad fuse is detected the GUI will show an alert. A reprogramming of this bad fuse is not allowed.

18) **Verification between written data and analogue data is mandatory, to be sure no bit is missing.**

19) With Save Date , the Resistance values of the OTP will be stored in a TXT-file

—

UPROG Programmer - Programming Procedure for ams AS5xxx series

7.2 ams AS5045B

7.2.1 Hardware

PINOUT: 20 PIN Connector to AS5045B

Connector on the SD4Y Programmer

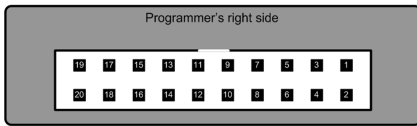

Pinout AS5145

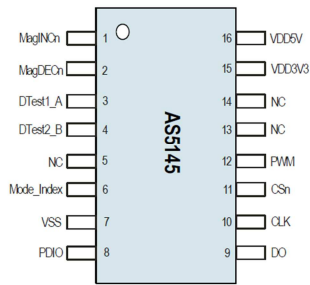

*copyright by ams 2013

Connection between SD4Y and AS5045B

SD4Y Connector	AS5045B
PinNr	PinDescription
1	Vprog
2	Vprog
13	GND
14	GND
11	Vdd
12	Vdd
15	DO
17	CSn
20	CLK

7.2.2 Programming Procedure and Function Description for the ams AS5045B

1) Start the GUI



UPROG Programmer - Programming Procedure for ams AS5xxx series



- e) Press the  Button. The Status will change to the green checkmark.
- f) Please check if the latest firmware is used. For a firmware update, please connect the programmer to the USB , choose the right COM and press the FW upgrade

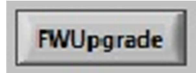

Button
If the update was successful, the FW- Version will change.

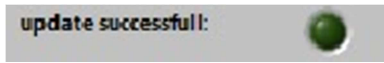

Additional the marker will be green.



- 2) Choose the right Device (AS5045B)
- 3) The GUI will change to the right Device

The screenshot shows the UPROG Programmer GUI. At the top, there are controls for the Serial Port (COM10), FW version (1.26), and an 'update successful' indicator (green dot). A 'Device' dropdown menu is set to 'AS5045B'. Below this, there are tabs for 'SS1' and 'OTP'. A caution message reads: 'Caution: smaller 100pF on PROG-PIN, if not, fuses are damaged !!'. The main area is divided into sections for 'bad fuse detected', '5V VDD', and a 'Resistance [Ohm]' graph. The graph shows a logarithmic scale from 10 to 100,000 Ohms over 55 fuses. To the right, there are two columns of checkboxes for 'AS5045 CS' and 'AS5045 FS', each with a 'Resistance' value of 0,0. The 'AS5045 CS' column includes options like 'mbit1 (FS)', 'PWMHalfEN', 'MagCompEN', 'pwmDis', 'Reserved1', 'Reserved2', 'Z0' through 'Z11', 'CCW', 'RAddress0' through 'RAddress4', 'IntpHyst0', and 'IntpHyst1'. The 'AS5045 FS' column includes options 'FS 1' through 'FS 27' and 'mbit0'.

- 4) Set the VDD to the right Value
- 5) To use the **OTP TAB Area** first is important.
- 6) **SS1 Tab** : If a zero programming is necessary.

UPROG Programmer - Programming Procedure for ams AS5xxx series

By selecting the SSI tab, information of the angular position and the status bits appear:

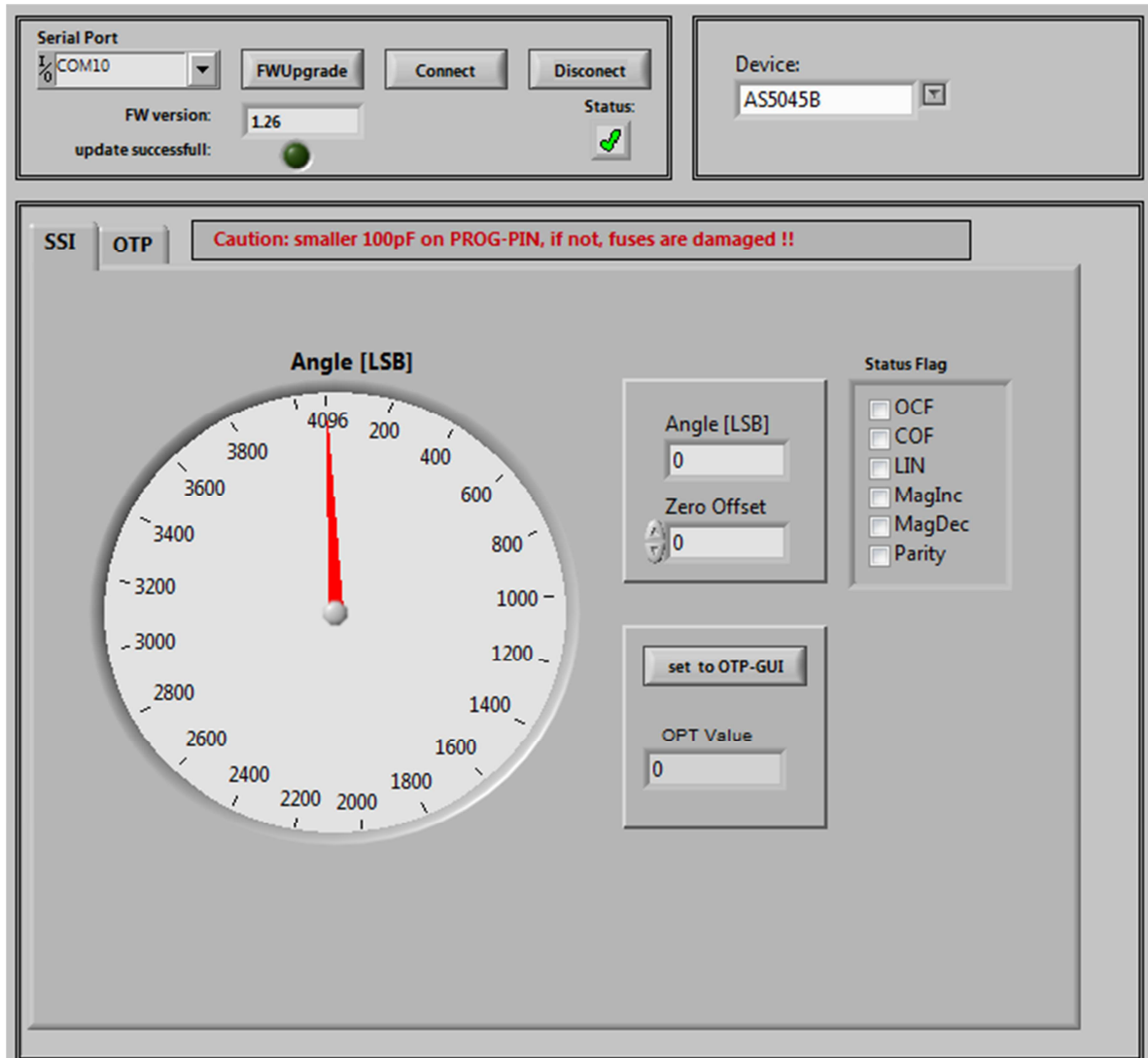

- Angle [LSB] Graphic is showing the actual position of the magnet.
- Angle [LSB] is showing the actual position of the magnet in LSB
- Zero Offset: For adding or subtracting an offset to the current Angle position
- Set to OTP-GUI: The OPT Value is showing the Angle + the zero offset. With pushing the “Set to OTP-GUI” button the information of the OPT Value is stored in the AS5145CS area of the OTP Tab.
- Status flag: The Status Flag displays the status bits extracted from the SSI.

UPROG Programmer - Programming Procedure for ams AS5xxx series

- 7) Push the “set to OTP-GUI” for setting the zero point or use the manual setting of the zero

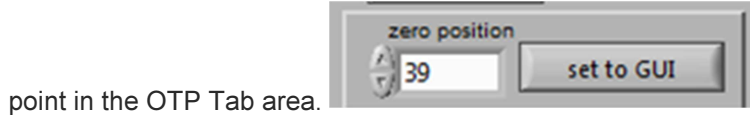

- 8) **Change to the OTP Area.**

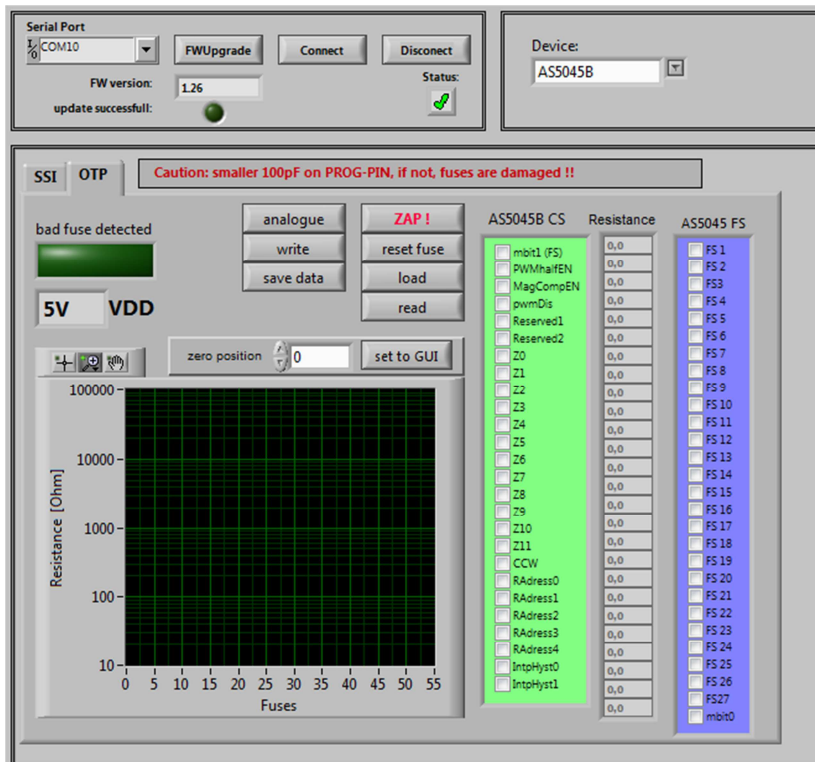

- 9) Select necessary Bits for programming in the **AS5045B CS** (Customer settings)

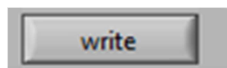

- 10) Push the write button

11) The OTP Write was successful.

12) Several writing is possible.

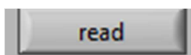

13) Push the read button if a digital reading is necessary

14) Several digital reading is possible.

UPROG Programmer - Programming Procedure for ams AS5xxx series

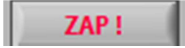
15) If the values in the AS5045B CS area are right, push  Button for permanent programming.

16) **Push Analogue. The analog read back is mandatory, after programming!**

Warning: It's not allowed to connect a capacitor to the VPRog. This can destroy all OTP Bits during the analog read back

17) In the "Resistance" area is the OTP Fuse resistance Information of all Customer Bits.

Programmed Fuse: 50 - 200 Ohm

Unprogrammed Fuse: >10 kOhm

Bad Fuse: 200 Ohm - 10 kOhm

If a bad fuse is detected the GUI will show an alert. A reprogramming of this bad fuse is not allowed.

18) Verification between written data and analogue data is mandatory, to be sure no bit is missing.

19) With Save Date , the Resistance values of the OTP will be stored in a TXT-file

—

UPROG Programmer - Programming Procedure for ams AS5xxx series

7.3 ams AS5043

7.3.1 Hardware

PINOUT: 20 PIN Connector to AS5043

Connector on the SD4Y Programmer

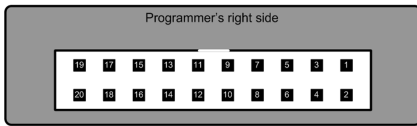

Pinout AS5043

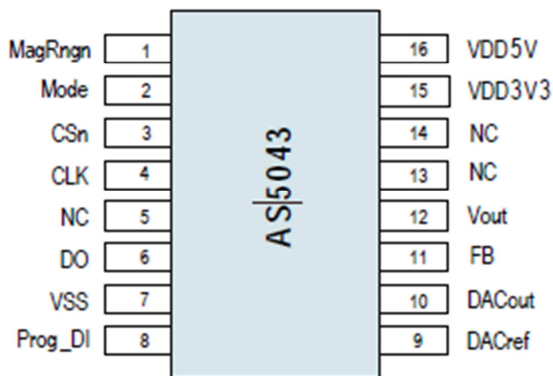

*copyright by ams 2013

Connection between SD4Y and AS5043

SD4Y Connector	AS5043
PinNr	PinDescription
1	Prog_DI
2	Prog_DI
13	VSS
14	VSS
11	VDD5V
12	VDD5V
15	DO
17	CSn
20	CLK

7.3.2 Programming Procedure and Function Description for the ams AS5043

1) Start the GUI

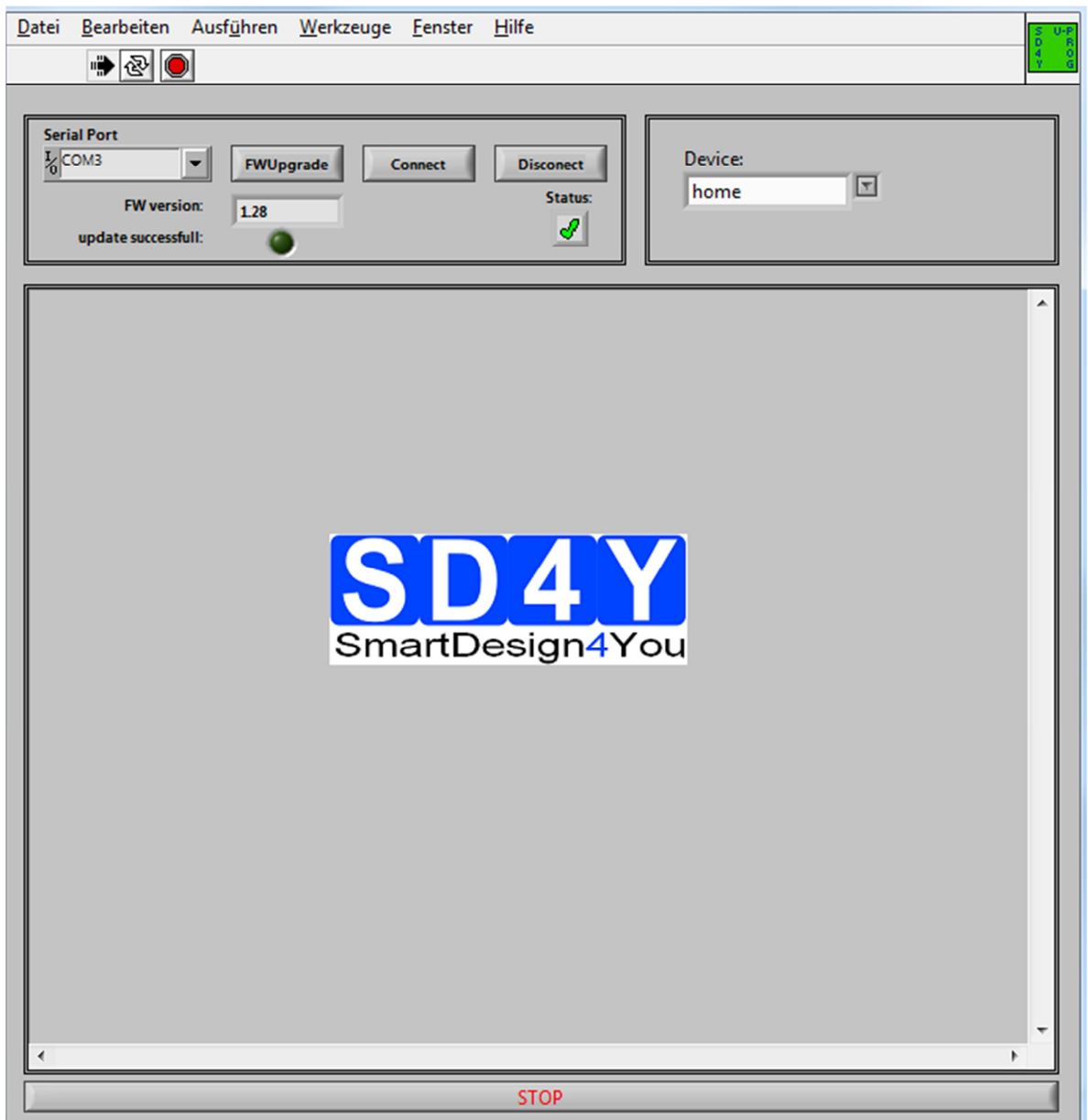

g) Choose the right COM Port



UPROG Programmer - Programming Procedure for ams AS5xxx series



- h) Press the  Button. The Status will change to the green checkmark.
- i) Please check if the latest firmware is used. For a firmware update, please connect the programmer to the USB , choose the right COM and press the FW upgrade

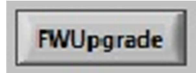

Button

If the update was successful, the FW- Version will change.

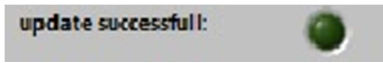

Additional the  marker will be green.



- 2) Choose the right Device  (AS5043)
- 3) The GUI will change to the right Device

The screenshot shows the UPROG Programmer interface. At the top, there are controls for the serial port (COM3), FW version (1.2e), and a status indicator (green checkmark). The device is set to AS5043. Below this, there are tabs for SSI and OTP. The main area displays a graph of VDD vs OTP with high and low limits. To the right, there are checkboxes for various pins (Z0-Z9, FB int EN, Ref Ext EN, Clamp Md EN, Output Range1, Output Range0) and fuses (FS 1-16). Buttons for OTP-read, analogue, write, Zap!, and save data are also visible. A red STOP button is at the bottom.

- 4) Set the VDD to the right Value
- 5) To use the **OTP TAB Area** first is important

UPROG Programmer - Programming Procedure for ams AS5xxx series

6) SSI Tab : If a zero programming is necessary.

By selecting the SSI tab, information of the angular position and the status bits appear:

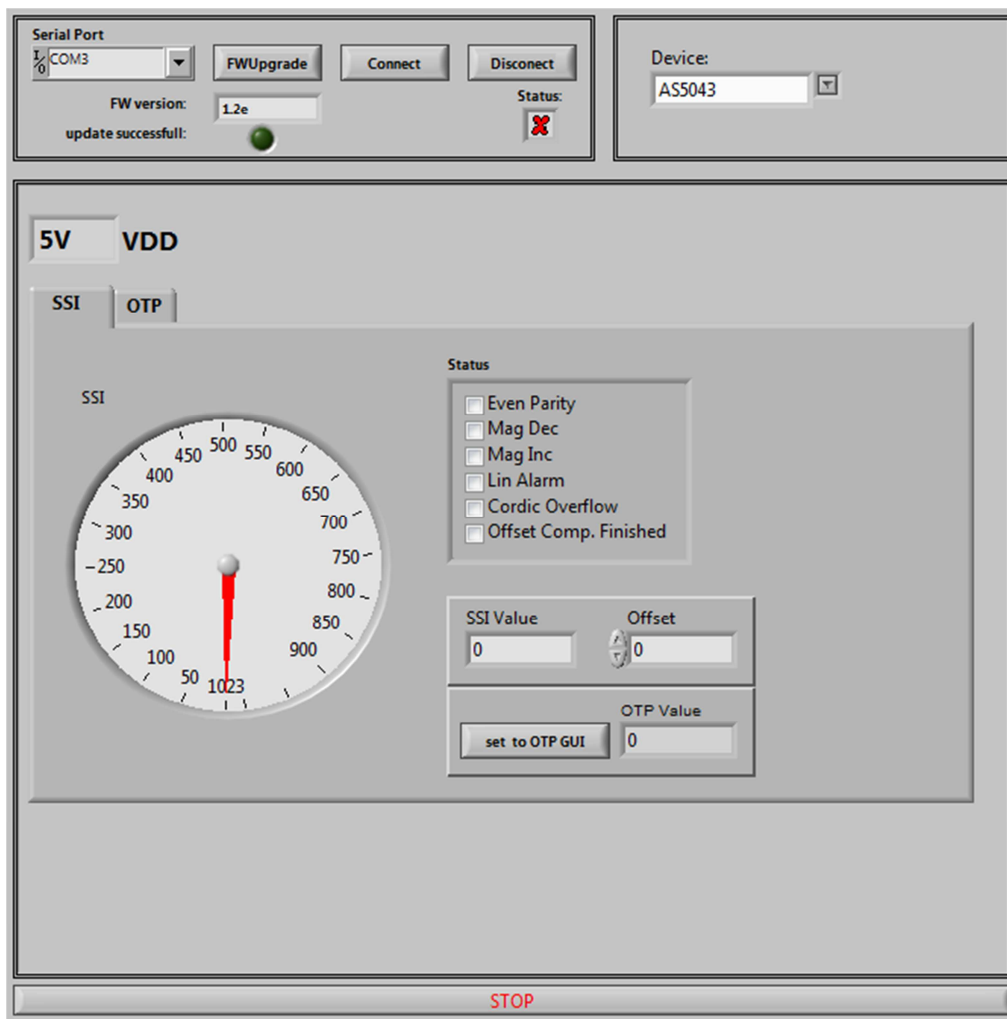

- Angle [LSB] Graphic is showing the actual position of the magnet.
- Angle [LSB] is showing the actual position of the magnet in LSB
- Zero Offset: For adding or subtracting an offset to the current Angle position
- Set to OTP-GUI: The OTP Value is showing the Angle + the zero offset. With pushing the "Set to OTP-GUI" button the information of the OTP Value is stored in the AS5145CS area of the OTP Tab.
- Status flag: The Status Flag displays the status bits extracted from the SSI.

UPROG Programmer - Programming Procedure for ams AS5xxx series

- 7) Push the “set to OTP-GUI” for setting the zero point or use the manual setting of the zero

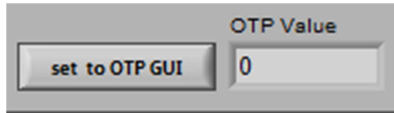

point in the OTP Tab area.

- 8) Change to the OTP Area.

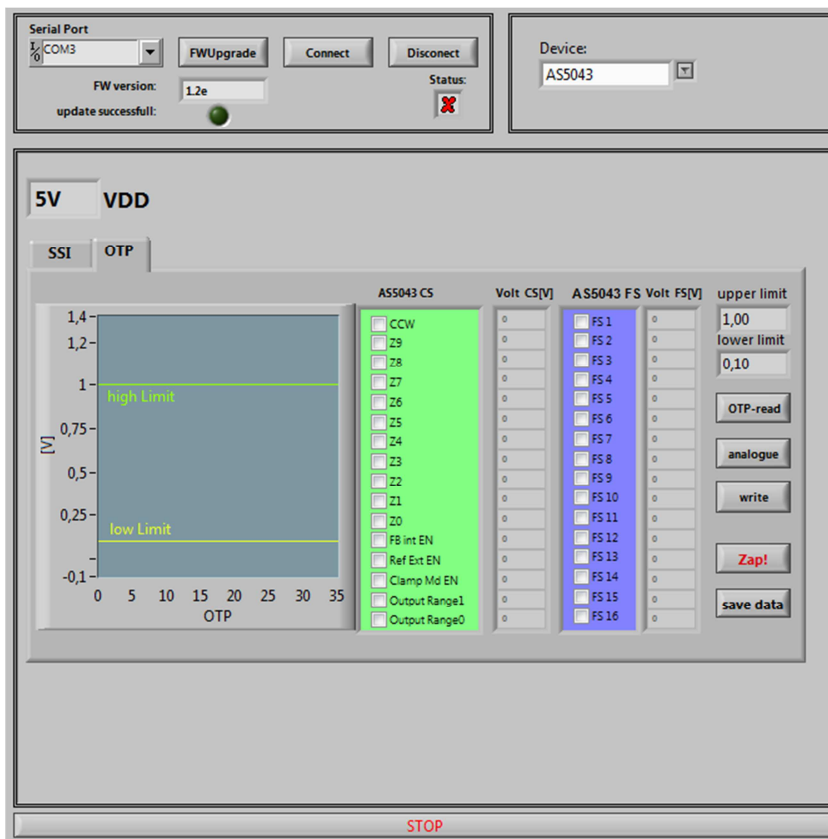

- 9) Select necessary Bits for programming in the **AS5043 CS** (Customer settings)

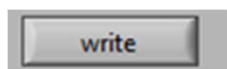

- 10) Push the write button

- 11) The OTP Write was successful.

- 12) Several writing is possible.

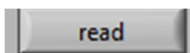

- 13) Push the read button if a digital reading is necessary

UPROG Programmer - Programming Procedure for ams AS5xxx series

- 14) Several digital reading is possible.
- 15) If the values in the AS5043 CS area are right, push  Button for permanent programming.
- 16) **Push Analogue. The analog read back is mandatory, after programming!**
Warning: It's not allowed to connect a capacitor to the VPRog. This can destroy all OTP Bits during the analog read back
- 17) In the "Volt CS[V]" area is the OTP Fuse voltage Information of all Customer Bits.
Programmed Fuse: < 0,1 V
Unprogrammed Fuse: >1V
Bad Fuse: 0,1V - 1 V
- If a bad fuse is detected the GUI will show an alert. A reprogramming of this bad fuse is not allowed.
- 18) **Verification between written data and analogue data is mandatory; to be sure no bit is missing.**
- 19) With Save Date , the Resistance values of the OTP will be stored in a TXT-file

UPROG Programmer - Programming Procedure for ams AS5xxx series

7.4 ams AS5045

7.4.1 Hardware

PINOUT : 20 PIN Connector to AS5045

Connector on the SD4Y Programmer

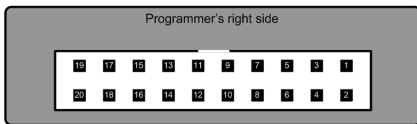

Pinout AS5045

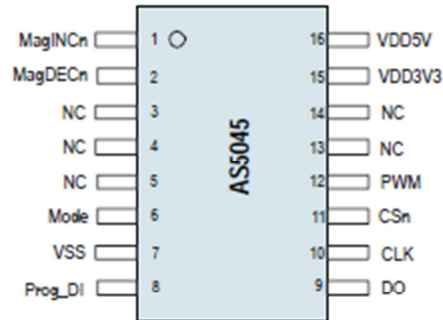

*copyright by ams 2013

Connection between SD4Y and AS5045

SD4Y Connector	AS5045
PinNr	PinDescription
1	Prog_DI
2	Prog_DI
13	GND
14	GND
11	Vdd
12	Vdd
15	DO
17	CSn
20	CLK

7.4.2 Programming Procedure and Function Description for the ams AS5045

1) Start the GUI

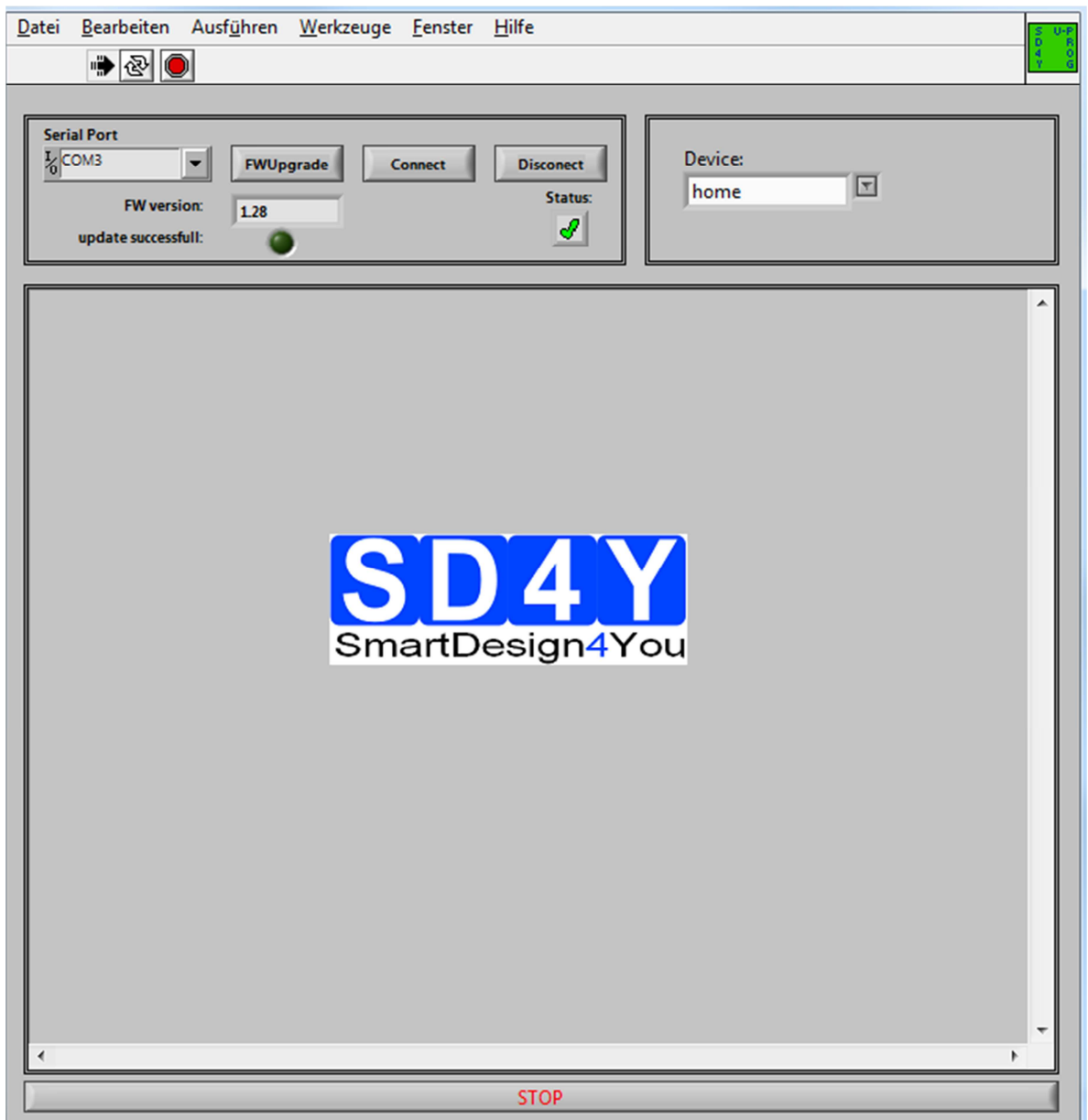

j) Choose the right COM Port



UPROG Programmer - Programming Procedure for ams AS5xxx series



- k) Press the  Button. The Status will change to the green checkmark.
- l) Please check if the latest firmware is used. For a firmware update, please connect the programmer to the USB , choose the right COM and press the FW upgrade

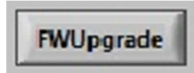

Button

If the update was successful, the FW- Version will change.

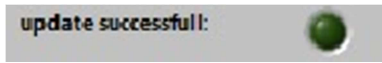

Additional the  marker will be green.



- 2) Choose the right Device  (AS5045)
- 3) The GUI will change to the right Device

The screenshot shows the UPROG Programmer GUI. At the top, there are controls for the Serial Port (COM3), FW version (1.2e), and update successful status (green dot). The Device dropdown is set to AS5045. The main area is divided into tabs for 5V, VDD, SSI, and OTP. The OTP tab is active, showing a graph of voltage [V] vs OTP and a table of parameters for AS5045 CS and AS5045 FS. The parameters are:

AS5045 CS	Voit CS[V]	AS5045 FS	Voit FS[V]	upper limit	lower limit
<input type="checkbox"/> CCW	0	<input type="checkbox"/> FS 1	0	1,00	0,10
<input type="checkbox"/> Z11	0	<input type="checkbox"/> FS 2	0		
<input type="checkbox"/> Z10	0	<input type="checkbox"/> FS 3	0		
<input type="checkbox"/> Z9	0	<input type="checkbox"/> FS 4	0		
<input type="checkbox"/> Z8	0	<input type="checkbox"/> FS 5	0		
<input type="checkbox"/> Z7	0	<input type="checkbox"/> FS 6	0		
<input type="checkbox"/> Z6	0	<input type="checkbox"/> FS 7	0		
<input type="checkbox"/> Z5	0	<input type="checkbox"/> FS 8	0		
<input type="checkbox"/> Z4	0	<input type="checkbox"/> FS 9	0		
<input type="checkbox"/> Z3	0	<input type="checkbox"/> FS 10	0		
<input type="checkbox"/> Z2	0	<input type="checkbox"/> FS 11	0		
<input type="checkbox"/> Z1	0	<input type="checkbox"/> FS 12	0		
<input type="checkbox"/> Z0	0	<input type="checkbox"/> FS 13	0		
<input type="checkbox"/> pwmDES	0	<input type="checkbox"/> FS 14	0		
<input type="checkbox"/> Mag Comp EN	0	<input type="checkbox"/> FS 15	0		
<input type="checkbox"/> PWM half EN	0	<input type="checkbox"/> FS 16	0		

Buttons for 'read', 'analogue', 'write', 'Zap!', and 'save data' are visible. A 'STOP' indicator is at the bottom.

- 4) Set the VDD to the right Value
- 5) To use the **OTP TAB Area** first is important.

UPROG Programmer - Programming Procedure for ams AS5xxx series

6) SSI Tab : If a zero programming is necessary.

By selecting the SSI tab, information of the angular position and the status bits appear:

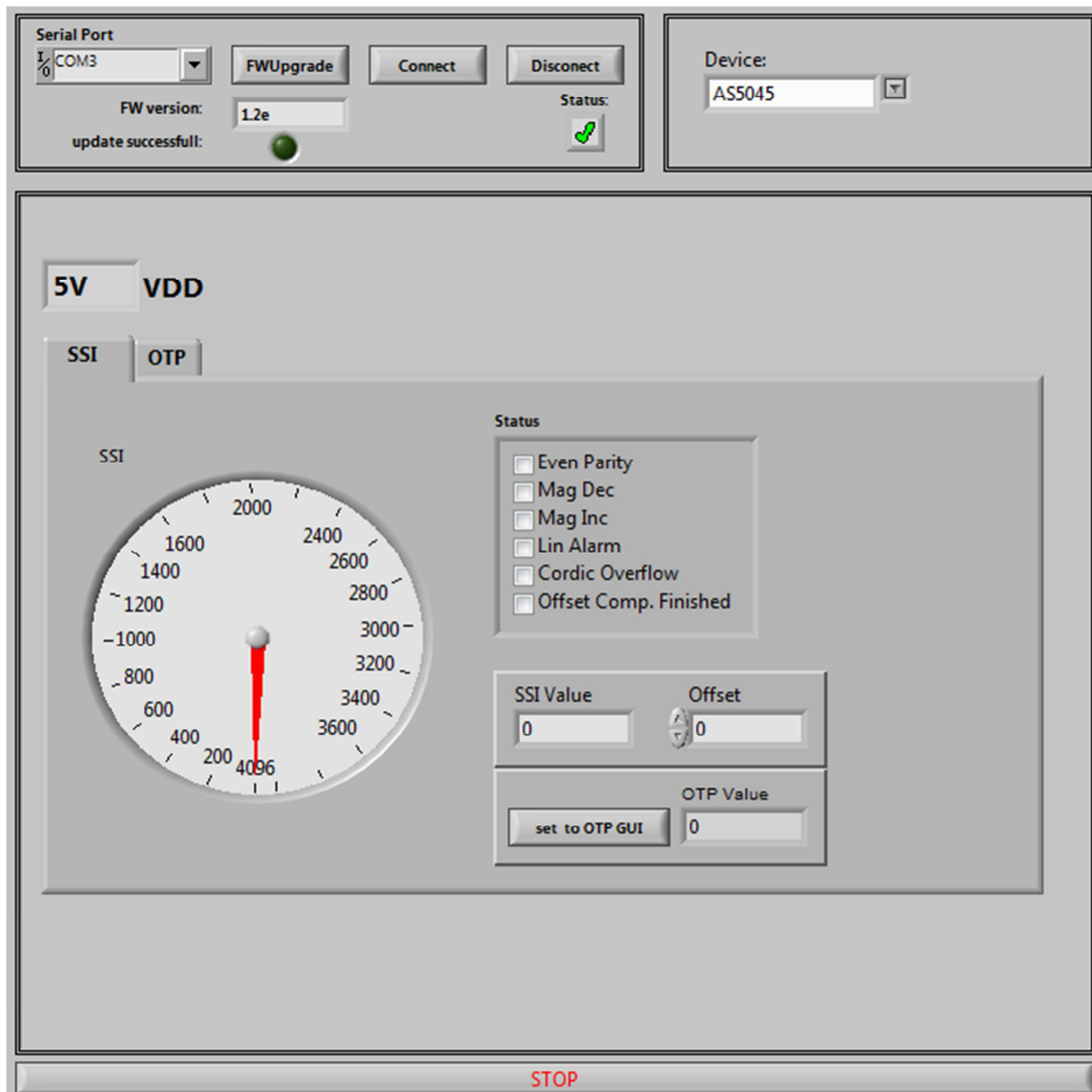

- Angle [LSB] Graphic is showing the actual position of the magnet.
- Angle [LSB] is showing the actual position of the magnet in LSB
- Zero Offset: For adding or subtracting an offset to the current Angle position
- Set to OTP-GUI: The OTP Value is showing the Angle + the zero offset. With pushing the “Set to OTP-GUI” button the information of the OTP Value is stored in the AS5145CS area of the OTP Tab.
- Status flag: The Status Flag displays the status bits extracted from the SSI.

UPROG Programmer - Programming Procedure for ams AS5xxx series

- 7) Push the “set to OTP-GUI” for setting the zero point or use the manual setting of the zero

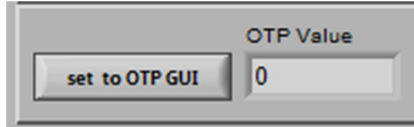

point in the OTP Tab area.

- 8) Change to the OTP Area.

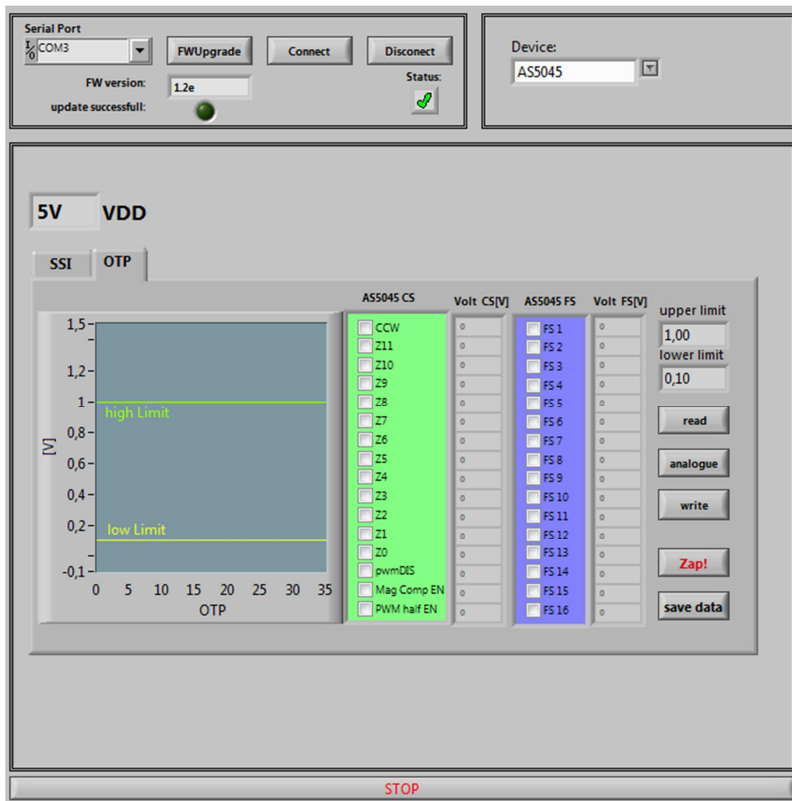

- 9) Select necessary Bits for programming in the **AS5045 CS** (Customer settings)

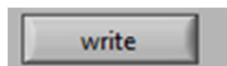

- 10) Push the write button

11) The OTP Write was successful.

12) Several writing is possible.

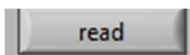

13) Push the read button if a digital reading is necessary

14) Several digital reading is possible.

UPROG Programmer - Programming Procedure for ams AS5xxx series

15) If the values in the AS5045 CS area are right, push  Button for permanent programming.

16) **Push Analogue. The analog read back is mandatory, after programming!**

Warning: It's not allowed to connect a capacitor to the VPRog. This can destroy all OTP Bits during the analog read back

17) In the "Volt CS[V]" area is the OTP Fuse voltage Information of all Customer Bits.

Programmed Fuse: < 0,1 V

Unprogrammed Fuse: >1V

Bad Fuse: 0,1V - 1 V

If a bad fuse is detected the GUI will show an alert. A reprogramming of this bad fuse is not allowed.

18) **Verification between written data and analogue data is mandatory, to be sure no bit is missing.**

19) With Save Date , the Resistance values of the OTP will be stored in a TXT-file

UPROG Programmer - Programming Procedure for ams AS5xxx series

7.5 ams AS5140

7.5.1 Hardware

PINOUT : 20 PIN Connector to AS5140

Connector on the SD4Y Programmer

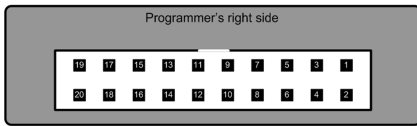

Pinout AS5140

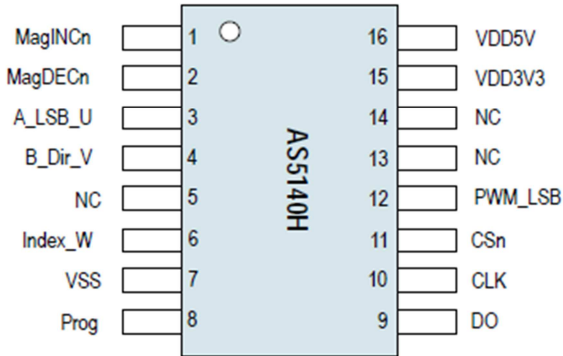

*copyright by ams 2013

Connection between SD4Y and AS5140

SD4Y Connector	AS5140
PinNr	PinDescription
1	Vprog
2	Vprog
13	GND
14	GND
11	Vdd
12	Vdd
15	DO
17	CSn
20	CLK

7.5.2 Programming Procedure and Function Description for the ams AS5140

1) Start the GUI

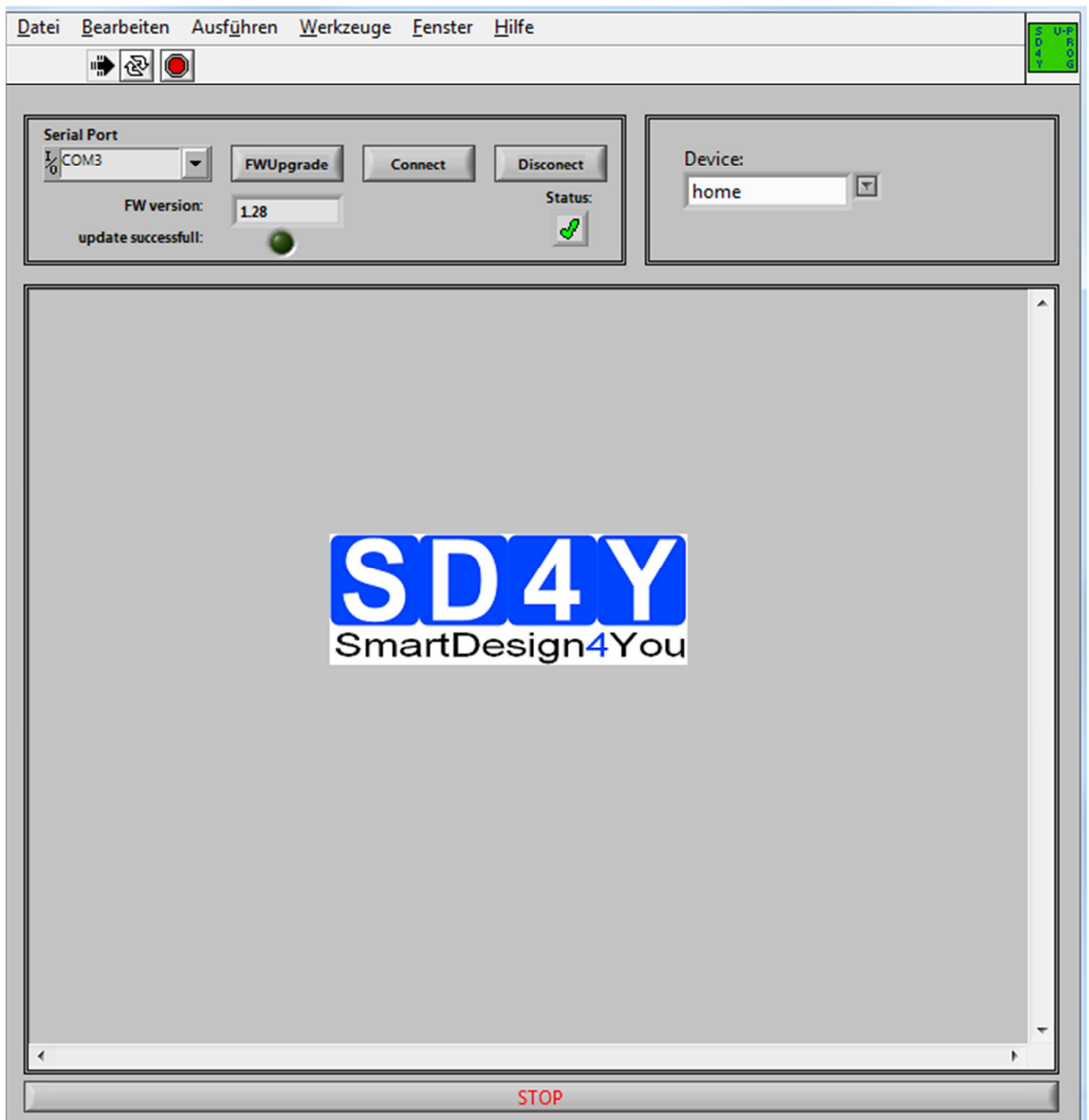

a) Choose the right COM Port



UPROG Programmer - Programming Procedure for ams AS5xxx series



- b) Press the  Button. The Status will change to the green checkmark.
- c) Please check if the latest firmware is used. For a firmware update, please connect the programmer to the USB , choose the right COM and press the FW upgrade

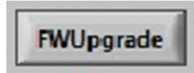

Button

If the update was successful, the FW- Version will change.

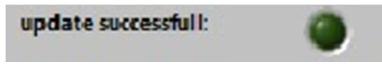

Additional the  marker will be green.



- 3) Choose the right Device  (AS5140)
- 4) The GUI will change to the right Device

The screenshot displays the UPROG Programmer GUI for the AS5140 device. At the top, the 'Serial Port' is set to COM3, and the 'FW version' is 1.2e. The 'update successful:' indicator is green. The main interface is divided into several sections:

- SS1 OTP:** Includes a caution message: "Caution: max capacitiv load on prog pin must not exceed 100pP".
- bad fuse detected:** A green bar indicates a bad fuse detected.
- 5V VDD:** Controls for setting the voltage and VDD.
- Resistance [Ohm]:** A graph showing resistance values for various fuses.
- AS5140 CS:** A list of fuses (mbit1 (FS) to RAddress4) with checkboxes and resistance values (0,0).
- AS5140 FS:** A list of fuses (FS 1 to mbit0) with checkboxes and resistance values (0,0).

- 5) Set the VDD to the right Value
- 6) To use the **OTP TAB Area** first is important.

UPROG Programmer - Programming Procedure for ams AS5xxx series

7) SSI Tab : If a zero programming is necessary.

By selecting the SSI tab, information of the angular position and the status bits appear:

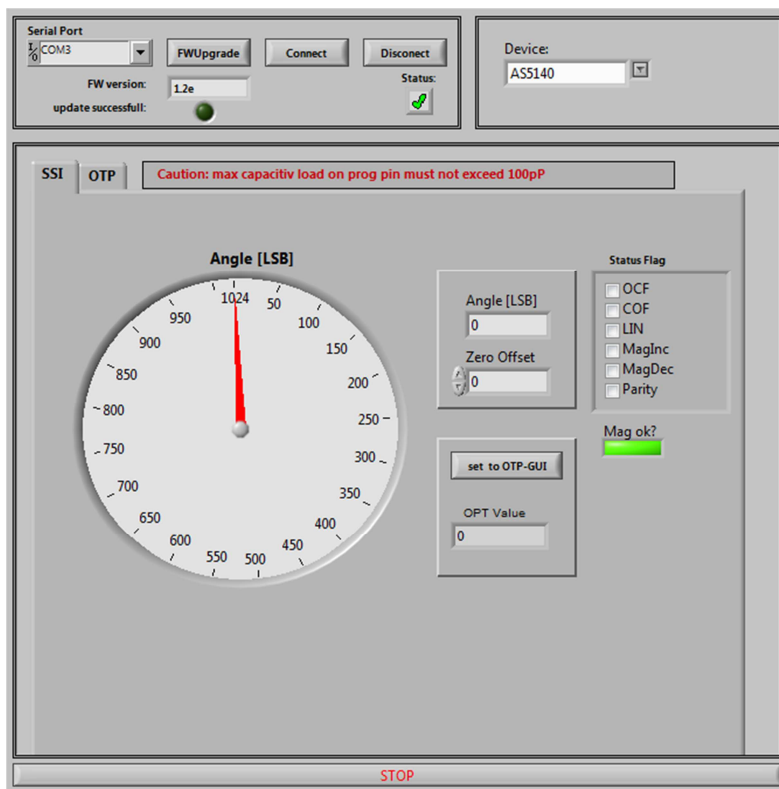

- Angle [LSB] Graphic is showing the actual position of the magnet.
- Angle [LSB] is showing the actual position of the magnet in LSB
- Zero Offset: For adding or subtracting an offset to the current Angle position
- Set to OTP-GUI: The OPT Value is showing the Angle + the zero offset. With pushing the “Set to OTP-GUI” button the information of the OPT Value is stored in the AS5145CS area of the OTP Tab.
- Status flag: The Status Flag displays the status bits extracted from the SSI.
- Mag ok? : The Status Flag displays the position of the magnet in z-distance.
Green = AGC is ok
Red = AGC is not ok

8) Push the “set to OTP-GUI” for setting the zero point or use the manual setting of the zero point in the OTP Tab area.

UPROG Programmer - Programming Procedure for ams AS5xxx series



9) **Change to the OTP Area.**

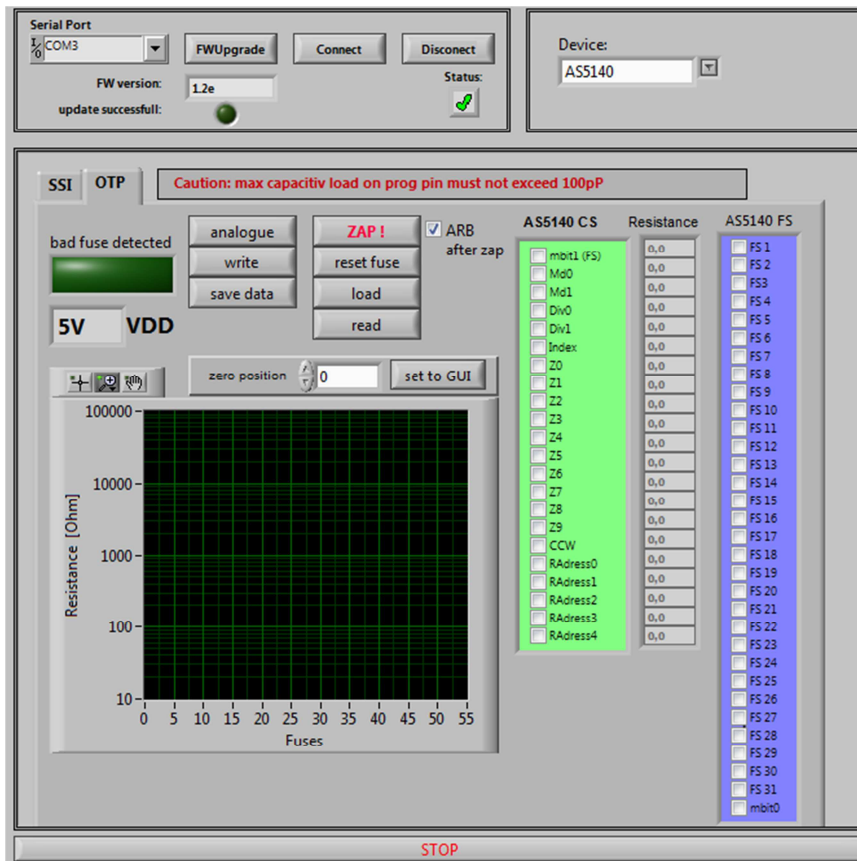

10) Select necessary Bits for programming in the **AS5140 CS** (Customer settings)

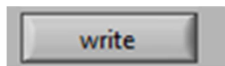

- 11) Push the write button
- 12) The OTP Write was successful.
- 13) Several writing is possible.

UPROG Programmer - Programming Procedure for ams AS5xxx series

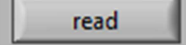
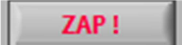
- 14) Push the read button  if a digital reading is necessary
- 15) Several digital reading is possible.
- 16) If the values in the AS5140 CS area are right, push  Button for permanent programming.
- 17) **Push Analogue. The analog read back is mandatory, after programming!**

The automatically analog read back is by default on

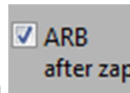

Warning: It's not allowed to connect a capacitor to the VPRog. This can destroy all OTP Bits during the analog read back

- 18) In the "Resistance" area is the OTP Fuse resistance Information of all Customer Bits.

Programmed Fuse: 50 - 200 Ohm

Unprogrammed Fuse: >10 kOhm

Bad Fuse: 200 Ohm - 10 kOhm

If a bad fuse is detected the GUI will show an alert. A reprogramming of this bad fuse is not allowed.

- 19) **Verification between written data and analogue data is mandatory, to be sure no bit is missing.**
- 20) With Save Date , the Resistance values of the OTP will be stored in a TXT-file

UPROG Programmer - Programming Procedure for ams AS5xxx series

7.6 ams AS5040

7.6.1 Hardware

PINOUT : 20 PIN Connector to AS5040

Connector on the SD4Y Programmer

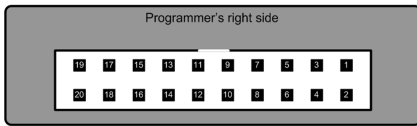

Pinout AS5040

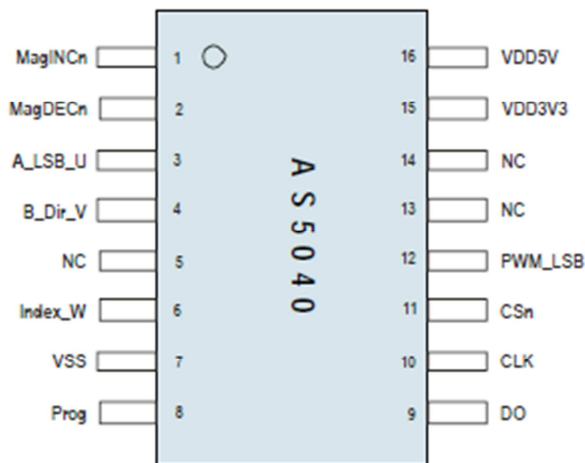

*copyright by ams 2013

Connection between SD4Y and AS5040

SD4Y Connector	AS5040
PinNr	PinDescription
1	Prog
2	Prog
13	VSS
14	VSS
11	VDD
12	VDD
15	DO
17	CSn
20	CLK

7.6.2 Programming Procedure and Function Description for the ams AS5040

21) Start the GUI

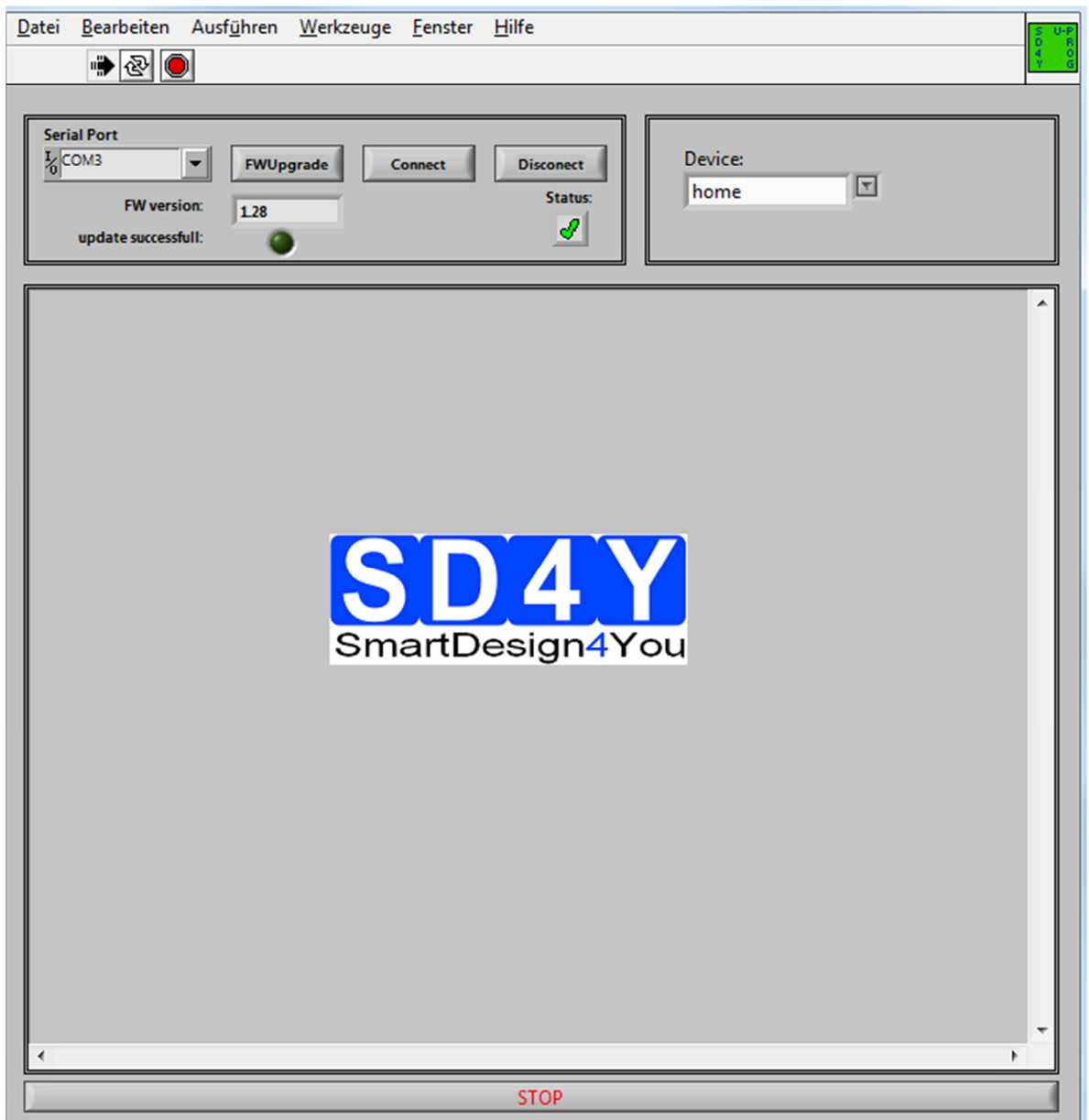

22) Choose the right COM Port

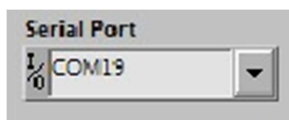

UPROG Programmer - Programming Procedure for ams AS5xxx series



23) Press the **Connect** Button. The Status will change to the green checkmark.

24) Please check if the latest firmware is used. For a firmware update, please connect the programmer to the USB, choose the right COM and press the FW upgrade Button

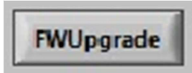

If the update was successful, the FW- Version will change.

Additional the **update successful:**  marker will be green.

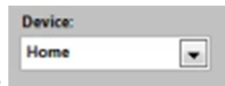

25) Choose the right Device **Home** (AS5040)

26) The GUI will change to the right Device

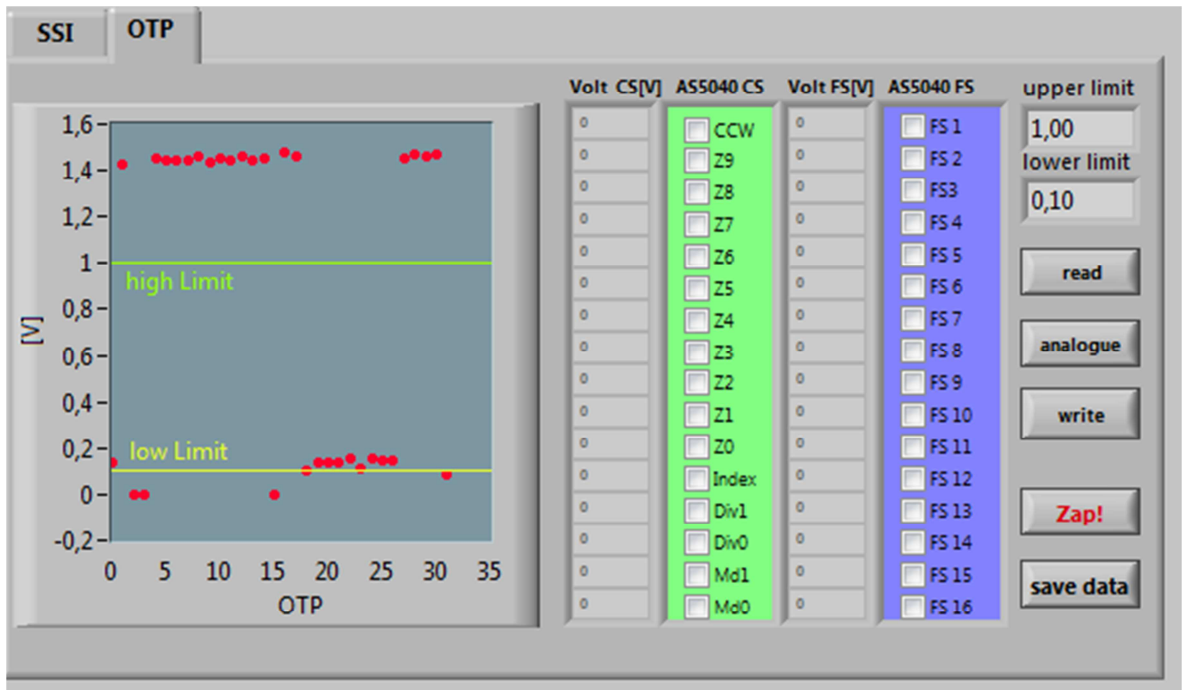

27) Set the VDD to the right Value

28) To use the **OTP TAB Area** first is important

29) **SSI Tab : If a zero programming is necessary.**

By selecting the SSI tab, information of the angular position and the status bits appear:

UPROG Programmer - Programming Procedure for ams AS5xxx series

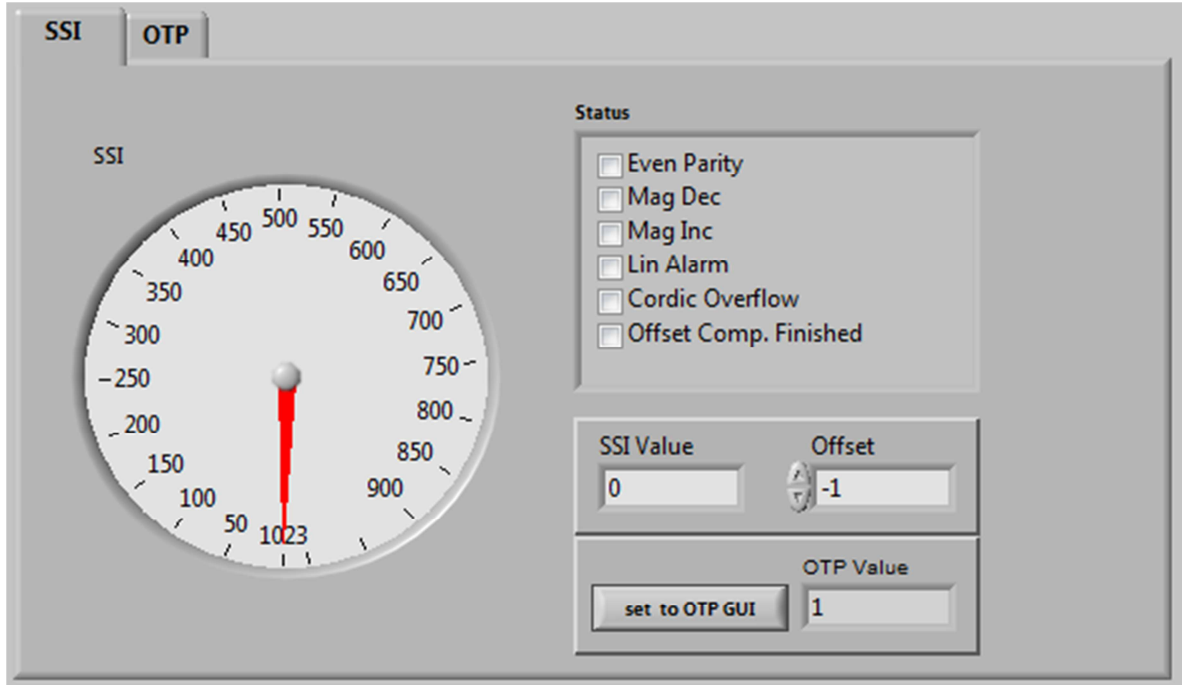

- SSI Graphic is showing the actual position of the magnet.
- SSI Value is showing the actual position of the magnet in LSB
- Offset : For adding or subtracting an offset to the current Angle position
- Set to OTP-GUI: The OTP Value is showing the Angle + the zero offset. With pushing the "Set to OTP-GUI" button the information of the OTP Value is stored in the AS5145CS area of the OTP Tab.
- Status flag: The Status Flag displays the status bits extracted from the SSI.

30) Push the "set to OTP-GUI" for setting the zero point .

UPROG Programmer - Programming Procedure for ams AS5xxx series

31) Change to the OTP Area.

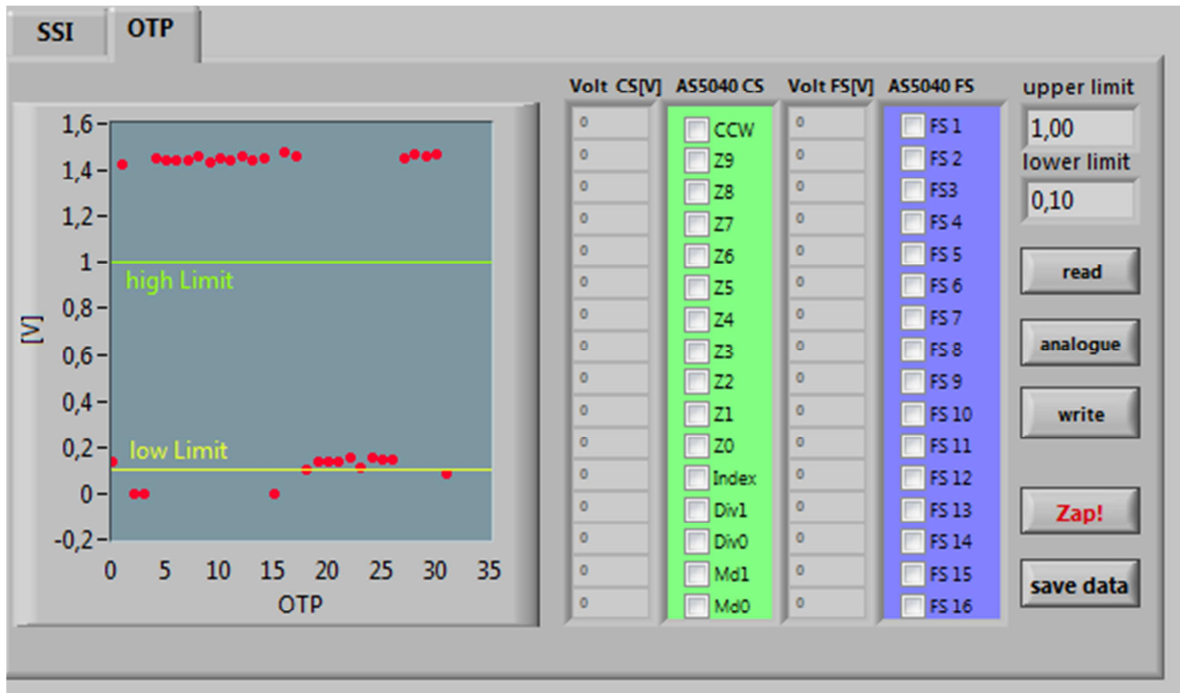

32) Select necessary Bits for programming in the **AS5040 CS** (Customer settings)

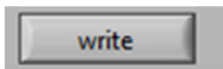

33) Push the write button

34) The OTP Write was successful.

35) Several writing is possible.



36) Push the read button if a digital reading is necessary.

37) Several reading is possible

38) If the values in the AS5040 CS area are right, push  Button for permanent programming.

39) **Push Analogue. The analog read back is mandatory, after programming!**

UPROG Programmer - Programming Procedure for ams AS5xxx series

40) In the "Volt CS[V]" area is the OTP Fuse voltage Information of all Customer Bits.

Programmed Fuse: < 0,1 V

Unprogrammed Fuse: >1V

Bad Fuse: 0,1V - 1 V

If a bad fuse is detected the GUI will show an alert. A reprogramming of this bad fuse is not allowed.

41) **Verification between written data and analogue data is mandatory, to be sure no bit is missing.**

42) With Save Date , the Resistance values of the OTP will be stored in a TXT-file

UPROG Programmer - Programming Procedure for ams AS5xxx series

7.7 ams AS5030

7.7.1 Hardware

PINOUT : 20 PIN Connector to AS5030

Connector on the SD4Y Programmer

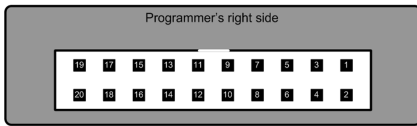

Pinout AS5030

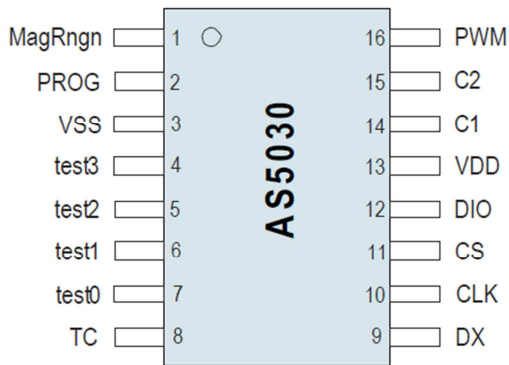

*copyright by ams 2013

Connection between SD4Y and AS5030

SD4Y Connector	AS5030
PinNr	PinDescription
1	Prog
2	Prog
13	VSS
14	VSS
11	VDD
12	VDD
7	DO
17	CSn
20	CLK

7.7.2 Programming Procedure and Function Description for the ams AS5030

1) Start the GUI

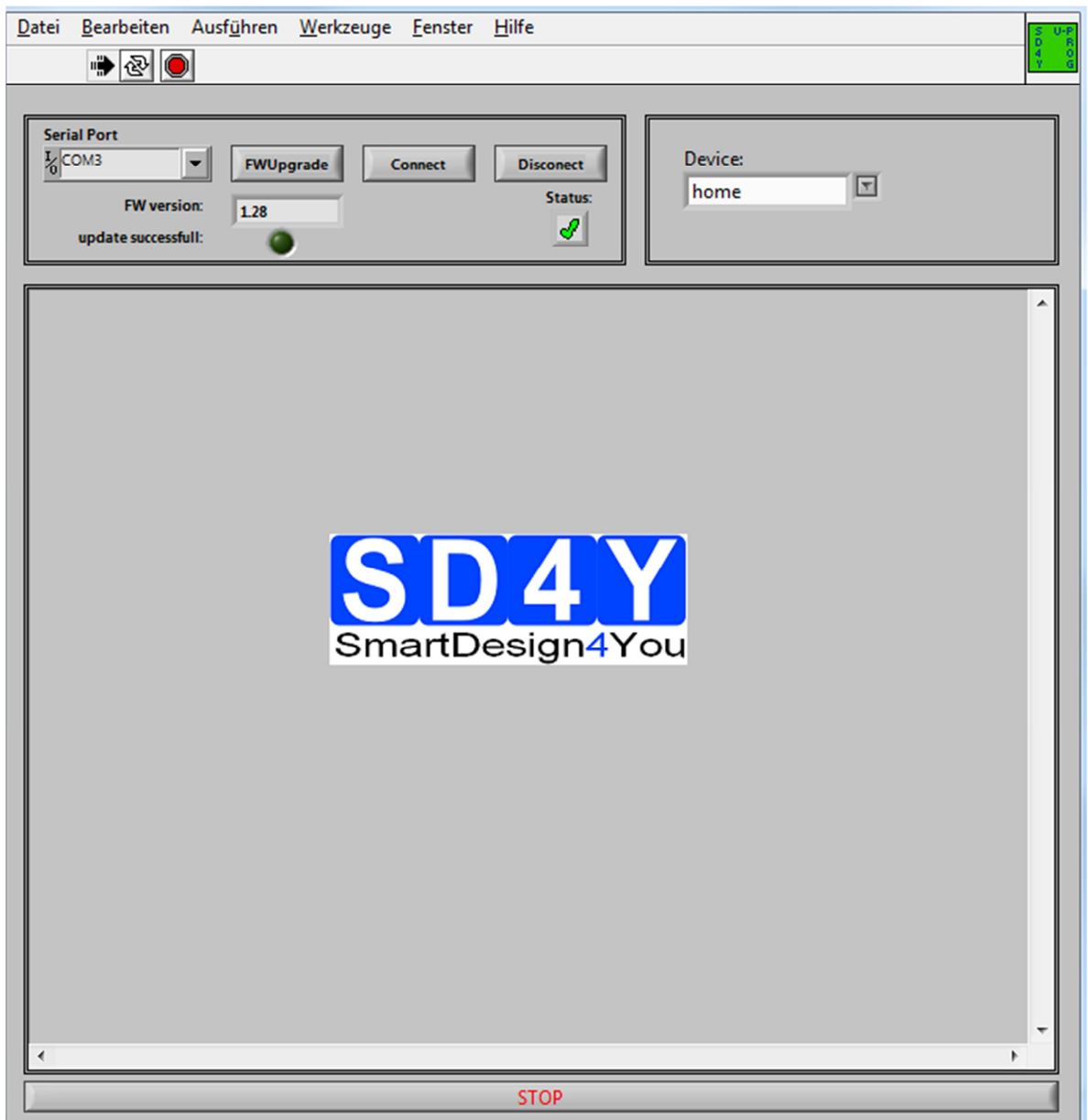

2) Choose the right COM Port



UPROG Programmer - Programming Procedure for ams AS5xxx series



- 3) Press the  Button. The Status will change to the green checkmark.
- 4) Please check if the latest firmware is used. For a firmware update, please connect the programmer to the USB , choose the right COM and press the FW upgrade Button

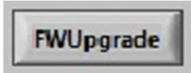

If the update was successful, the FW- Version will change.

Additional the  marker will be green.



- 43) Choose the right Device  (AS5030)
- 44) The GUI will change to the right Device

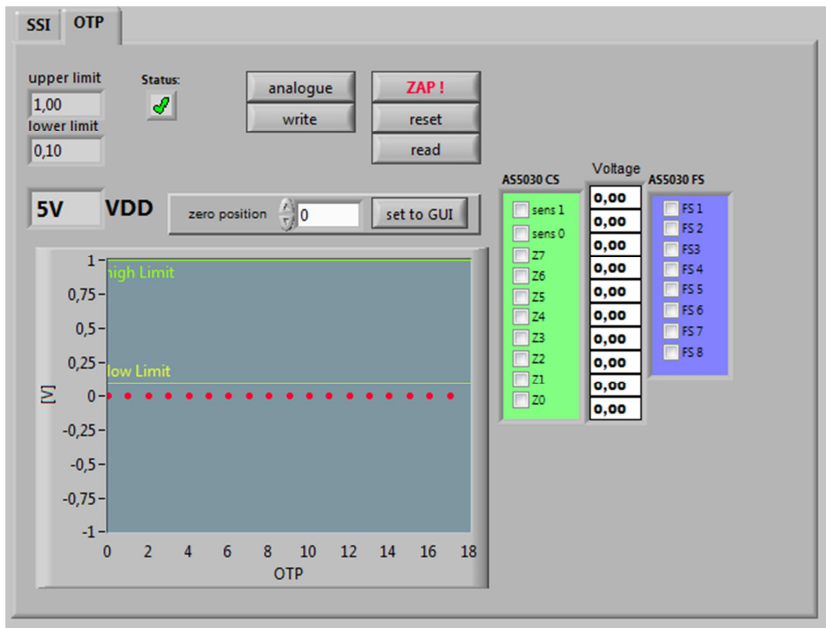

- 45) Set the VDD to the right Value
- 46) To use the **OTP TAB Area** first is important.
- 47) **SSI Tab : If a zero programming is necessary.**

By selecting the SSI tab, information of the angular position and the status bits appear:

UPROG Programmer - Programming Procedure for ams AS5xxx series

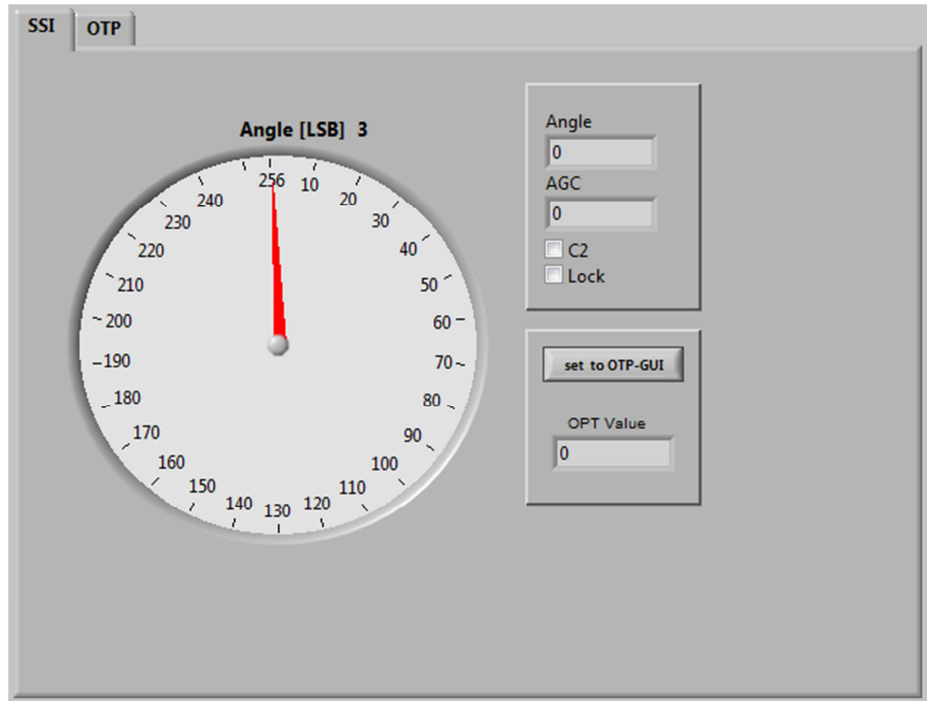

- SSI Graphic is showing the actual position of the magnet.
- Angle is showing the actual position of the magnet in LSB
- AGC is showing the actual AGC Value.
- C2 is showing the status of the hardware pin C2
- Lock is showing that AGC is locked
- Set to OTP-GUI: The OPT Value is showing the Angle. With pushing the “Set to OTP-GUI” button the information of the OPT Value is stored in the AS5030CS area of the OTP Tab.

48) Push the “set to OTP-GUI” for setting the zero point .

UPROG Programmer - Programming Procedure for ams AS5xxx series

49) Switch to the OTP Area.

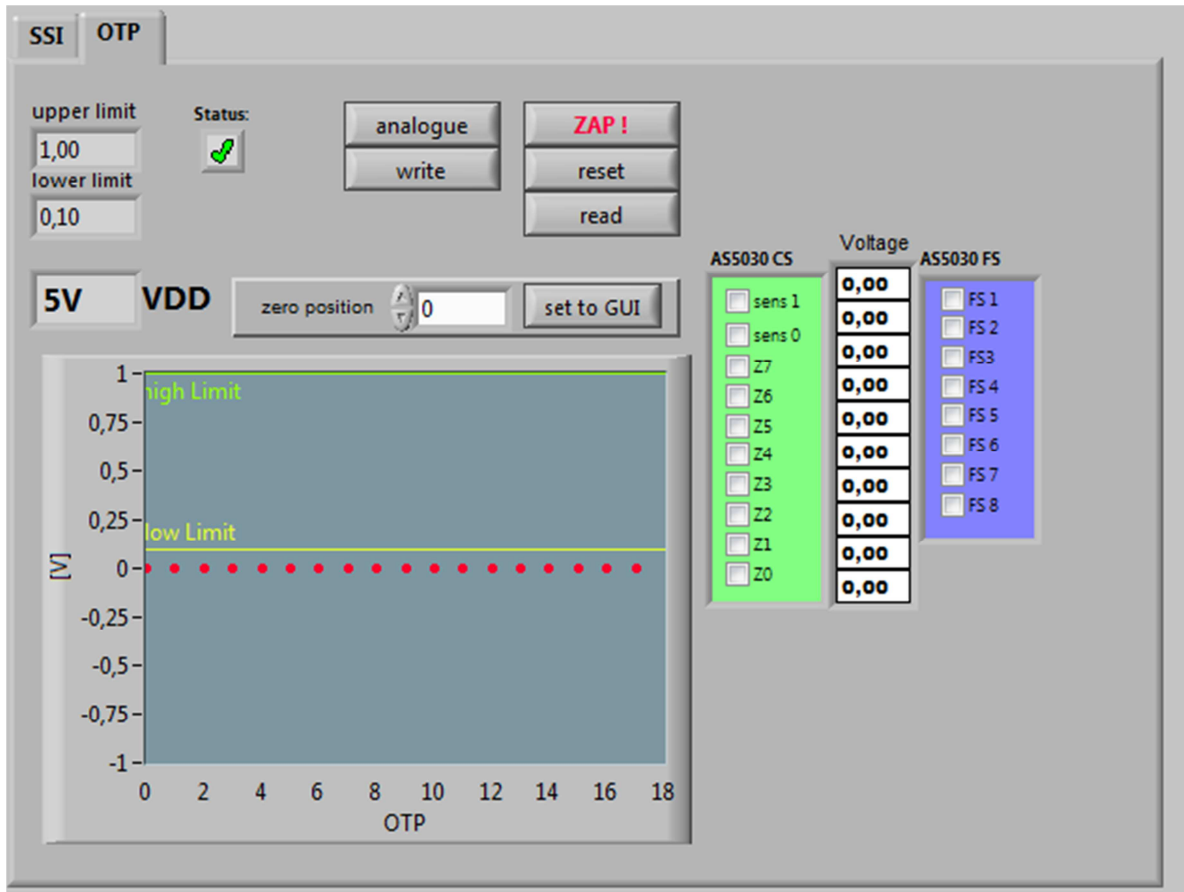

50) Select necessary Bits for programming in the **AS5030 CS** (Customer settings)

51) Push the write button 

52) The OTP Write was successful.

53) Several writing is possible.

54) Push the read button  if a digital reading is necessary.

55) Several reading is possible

56) If the values in the AS5040 CS area are right, push  Button for permanent programming.

UPROG Programmer - Programming Procedure for ams AS5xxx series

57) **Push Analogue. The analog read back is mandatory, after programming! Important: Analog Read Back for AS5030 is working with Hardware Revision 1.4 or higher**

58) In the "Volt CS[V]" area is the OTP Fuse voltage Information of all Customer Bits.

Programmed Fuse: < 0,1 V

Unprogrammed Fuse: >1V

Bad Fuse: 0,1V - 1 V

If a bad fuse is detected the GUI will show an alert. A reprogramming of this bad fuse is not allowed.

59) **Verification between written data and analogue data is mandatory; to be sure no bit is missing.**

60) With Save Date , the Resistance values of the OTP will be stored in a TXT-file

UPROG Programmer - Programming Procedure for ams AS5xxx series

7.8 ams AS5134

7.8.1 Hardware

PINOUT : 20 PIN Connector to AS5134

Connector on the SD4Y Programmer

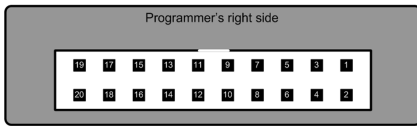

Pinout AS5134

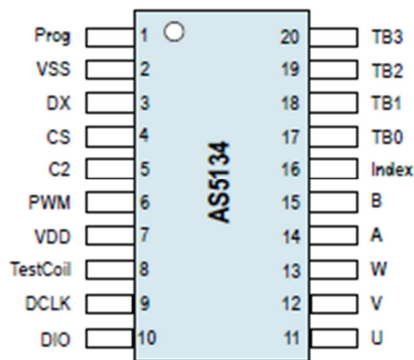

*copyright by ams 2013

Connection between SD4Y and AS5134

SD4Y Connector	AS5134
PinNr	PinDescription
1	Prog
2	Prog
13	VSS
14	VSS
11	VDD
12	VDD
7	DO
17	CSn
20	CLK

7.8.2 Programming Procedure and Function Description for the ams AS5134

- 1) Start the GUI

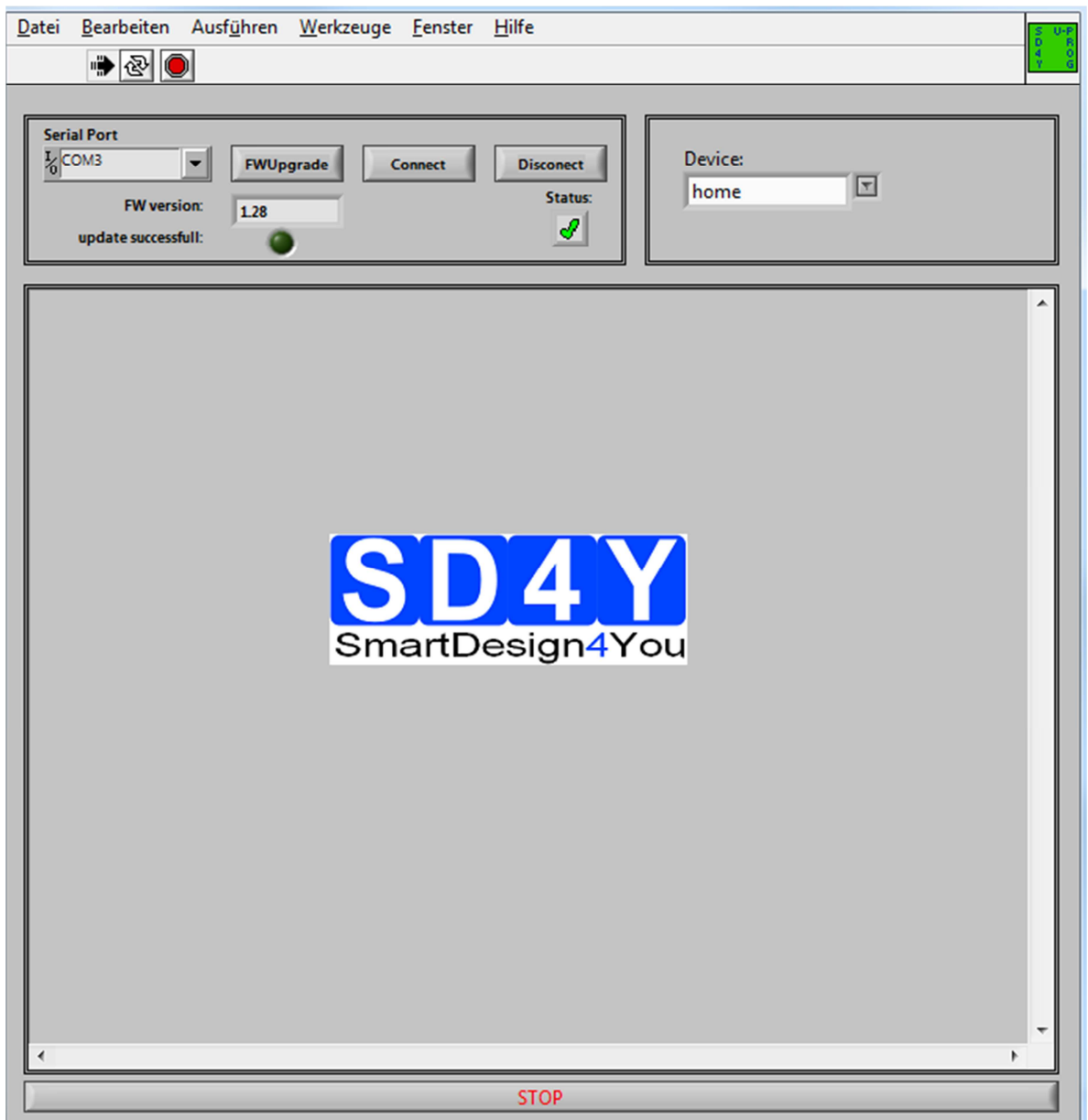

- 2) Choose the right COM Port

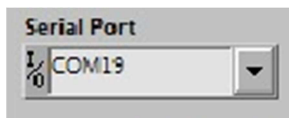

UPROG Programmer - Programming Procedure for ams AS5xxx series

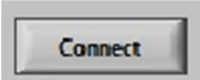

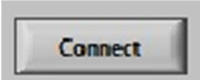
- 3) Press the  Button. The Status will change to the green checkmark.
- 4) Please check if the latest firmware is used. For a firmware update, please connect the programmer to the USB , choose the right COM and press the FW upgrade Button

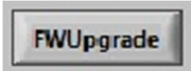

If the update was successful, the FW- Version will change.

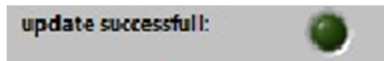

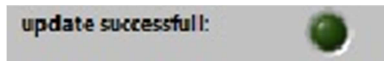
Additional the  marker will be green.

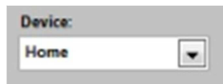

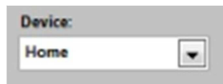
- 5) Choose the right Device  (AS5132)
- 6) The GUI will change to the right Device

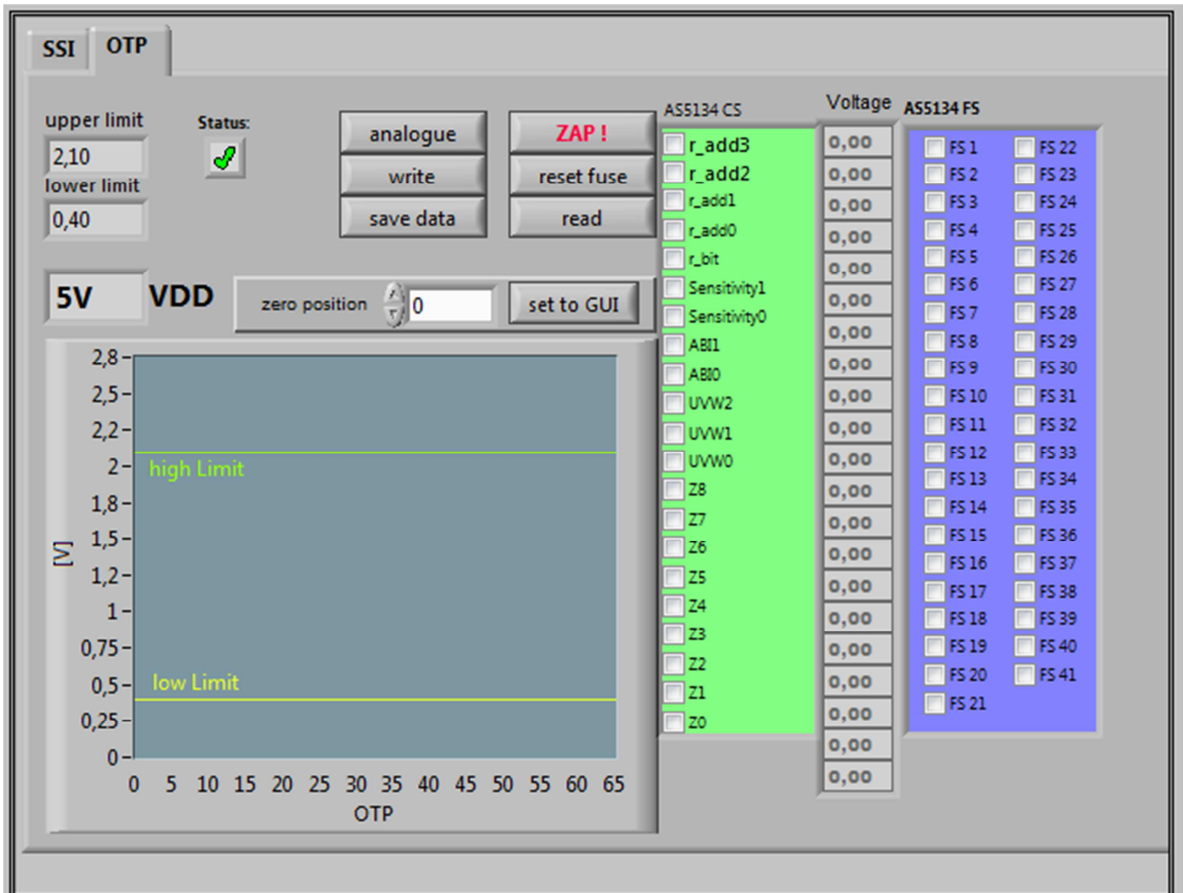

The screenshot shows the UPROG Programmer GUI for the AS5134 CS device. The interface includes several control panels and a data table.

SSI / OTP Section:

- upper limit: 2,10
- lower limit: 0,40
- Status: 
- Buttons: analogue, write, save data, ZAP!, reset fuse, read

VDD Section:

- 5V VDD
- zero position: 0
- set to GUI

Graph:

- Y-axis: [V] (0 to 2,8)
- X-axis: OTP (0 to 65)
- high Limit: ~2,10 V
- low Limit: ~0,40 V

AS5134 CS Parameters:

<input type="checkbox"/> r_add3	0,00
<input type="checkbox"/> r_add2	0,00
<input type="checkbox"/> r_add1	0,00
<input type="checkbox"/> r_add0	0,00
<input type="checkbox"/> r_bit	0,00
<input type="checkbox"/> Sensitivity1	0,00
<input type="checkbox"/> Sensitivity0	0,00
<input type="checkbox"/> AB11	0,00
<input type="checkbox"/> AB10	0,00
<input type="checkbox"/> UVW2	0,00
<input type="checkbox"/> UVW1	0,00
<input type="checkbox"/> UVW0	0,00
<input type="checkbox"/> Z8	0,00
<input type="checkbox"/> Z7	0,00
<input type="checkbox"/> Z6	0,00
<input type="checkbox"/> Z5	0,00
<input type="checkbox"/> Z4	0,00
<input type="checkbox"/> Z3	0,00
<input type="checkbox"/> Z2	0,00
<input type="checkbox"/> Z1	0,00
<input type="checkbox"/> Z0	0,00

Voltage AS5134 FS Parameters:

<input type="checkbox"/> FS 1	<input type="checkbox"/> FS 22
<input type="checkbox"/> FS 2	<input type="checkbox"/> FS 23
<input type="checkbox"/> FS 3	<input type="checkbox"/> FS 24
<input type="checkbox"/> FS 4	<input type="checkbox"/> FS 25
<input type="checkbox"/> FS 5	<input type="checkbox"/> FS 26
<input type="checkbox"/> FS 6	<input type="checkbox"/> FS 27
<input type="checkbox"/> FS 7	<input type="checkbox"/> FS 28
<input type="checkbox"/> FS 8	<input type="checkbox"/> FS 29
<input type="checkbox"/> FS 9	<input type="checkbox"/> FS 30
<input type="checkbox"/> FS 10	<input type="checkbox"/> FS 31
<input type="checkbox"/> FS 11	<input type="checkbox"/> FS 32
<input type="checkbox"/> FS 12	<input type="checkbox"/> FS 33
<input type="checkbox"/> FS 13	<input type="checkbox"/> FS 34
<input type="checkbox"/> FS 14	<input type="checkbox"/> FS 35
<input type="checkbox"/> FS 15	<input type="checkbox"/> FS 36
<input type="checkbox"/> FS 16	<input type="checkbox"/> FS 37
<input type="checkbox"/> FS 17	<input type="checkbox"/> FS 38
<input type="checkbox"/> FS 18	<input type="checkbox"/> FS 39
<input type="checkbox"/> FS 19	<input type="checkbox"/> FS 40
<input type="checkbox"/> FS 20	<input type="checkbox"/> FS 41
<input type="checkbox"/> FS 21	

- 7) Set the VDD to the right Value
- 8) To use the **OTP TAB Area** first is important.

UPROG Programmer - Programming Procedure for ams AS5xxx series

9) **SSI Tab : If a zero programming is necessary.**

By selecting the SSI tab, information of the angular position and the status bits appear:

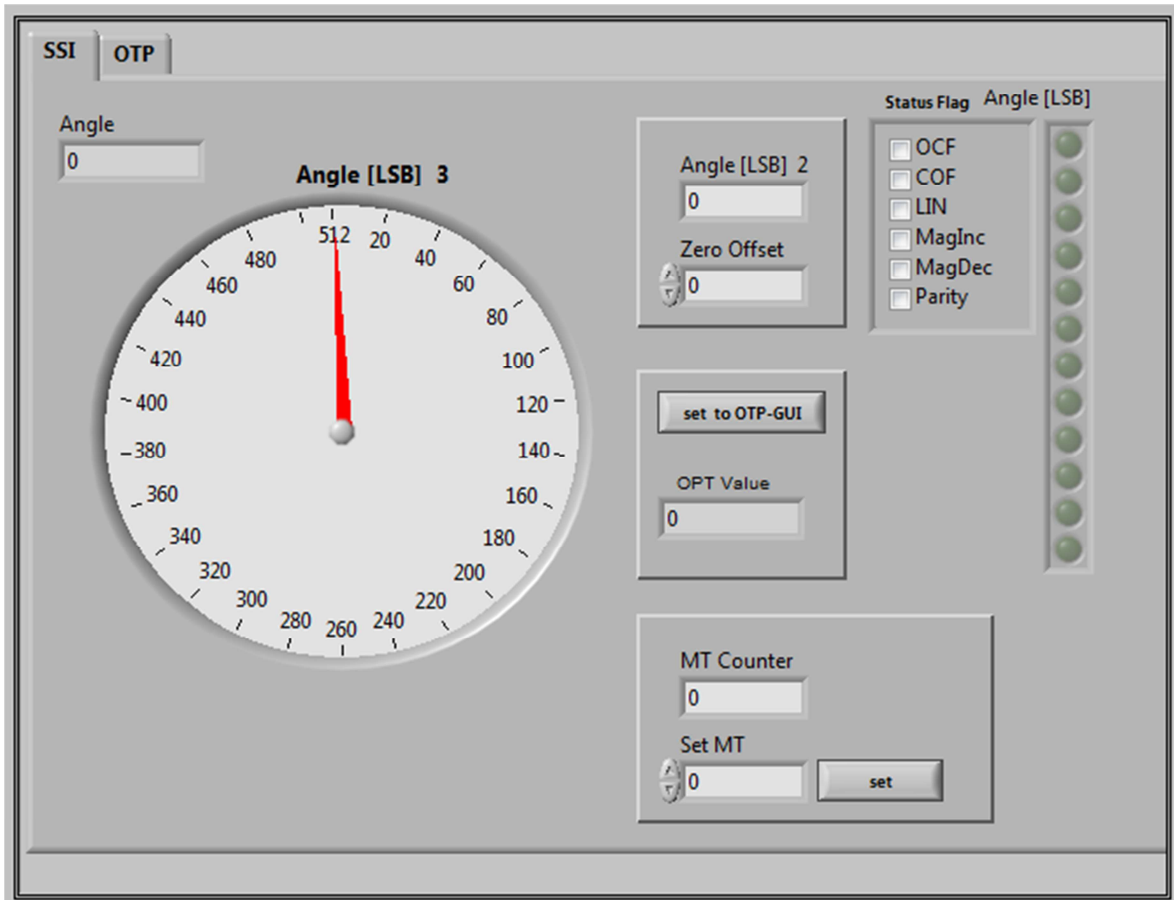

- SSI Graphic is showing the actual position of the magnet.
- Angle is showing the actual position of the magnet in LSB
- Status flag: The Status Flag displays the status bits extracted from the SSI.
- Set to OTP-GUI: The OTP Value is showing the Angle. With pushing the “Set to OTP-GUI” button the information of the OTP Value is stored in the AS5134CS area of the OTP Tab.
- zero offset can be add to the actual zero position
- MT Counter = digital multi counter . more information in the AMS AS5134 Datasheet

UPROG Programmer - Programming Procedure for ams AS5xxx series

- 10) Push the “set to OTP-GUI” for setting the zero point .
- 11) **Switch to the OTP Area.**

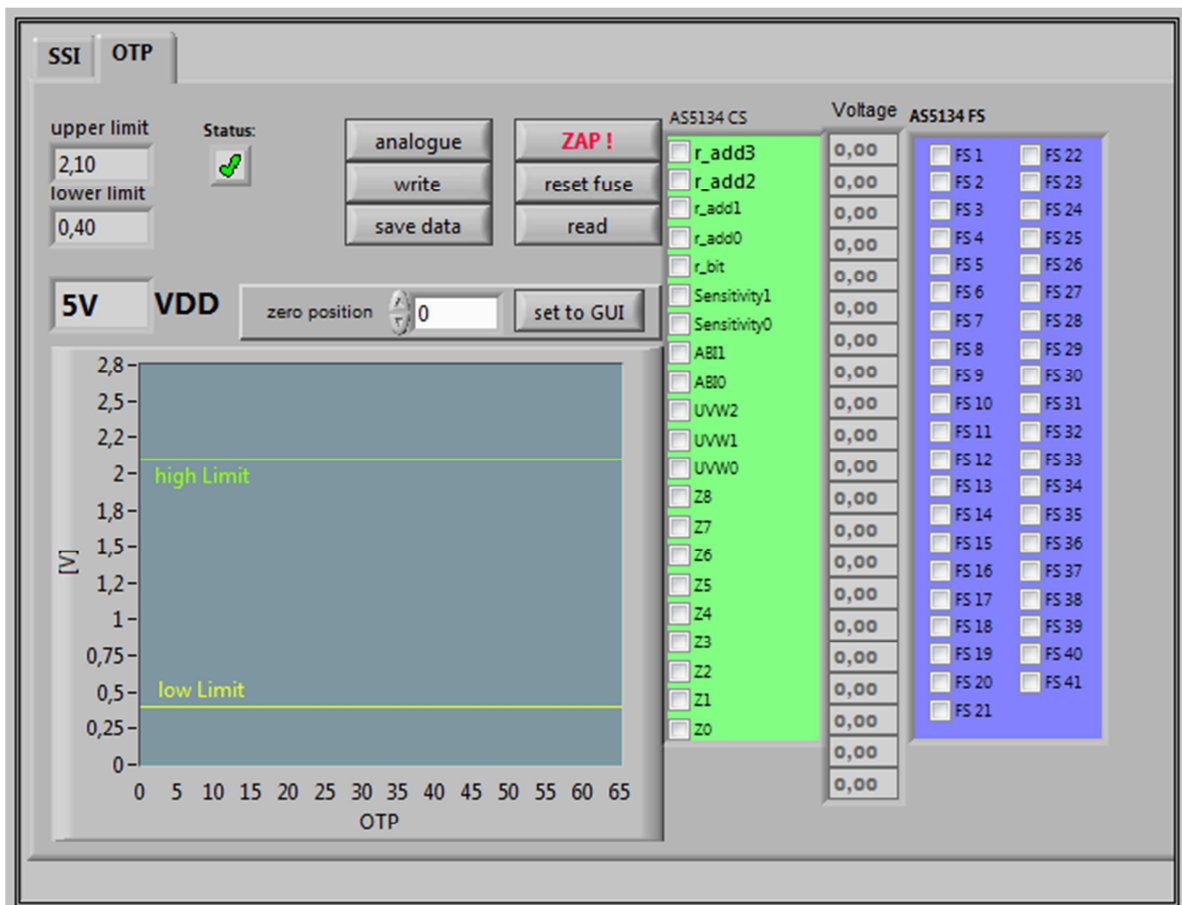

- 12) Select necessary Bits for programming in the **AS5134 CS** (Customer settings)

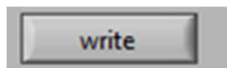

- 13) Push the write button
- 14) The OTP Write was successful.
- 15) Several writing is possible.

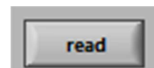

- 16) Push the read button if a digital reading is necessary and for verification.
- 17) Several reading is possible

UPROG Programmer - Programming Procedure for ams AS5xxx series

18) If the values in the AS5134 CS area are right, push  Button for permanent programming.

19) **Push Analogue. The analog read back is mandatory, after programming! Important: Analog Read Back for AS5134 is working with Hardware Revision 1.4 or higher**

20) In the "Volt CS[V]" area is the OTP Fuse voltage Information of all Customer Bits.

Programmed Fuse: < 0,4 V

Unprogrammed Fuse: >2,1V

Bad Fuse: 0,4V – 2,1 V

If a bad fuse is detected the GUI will show an alert. A reprogramming of this bad fuse is not allowed.

21) **Verification between written data and analogue data is mandatory; to be sure no bit is missing.**

22) With Save Date , the Resistance values of the OTP will be stored in a TXT-file

UPROG Programmer - Programming Procedure for ams AS5xxx series

7.9 ams AS5132

7.9.1 Hardware

PINOUT : 20 PIN Connector to AS5132

Connector on the SD4Y Programmer

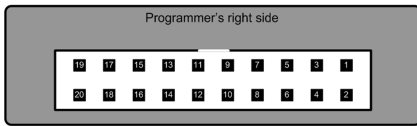

Pinout AS5132

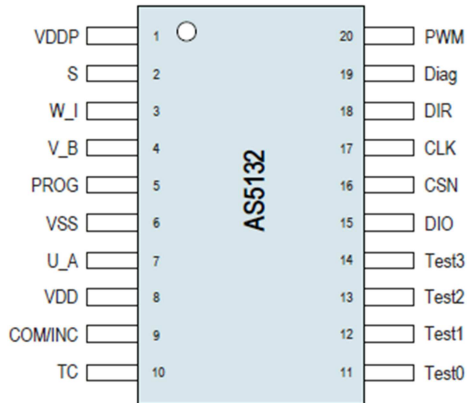

*copyright by ams 2013

Connection between SD4Y and AS5132

SD4Y Connector	AS5132
PinNr	PinDescription
1	Prog
2	Prog
13	VSS
14	VSS
11	VDD
12	VDD
7	DO
17	CSn
20	CLK

7.9.2 Programming Procedure and Function Description for the ams AS5030

1) Start the GUI

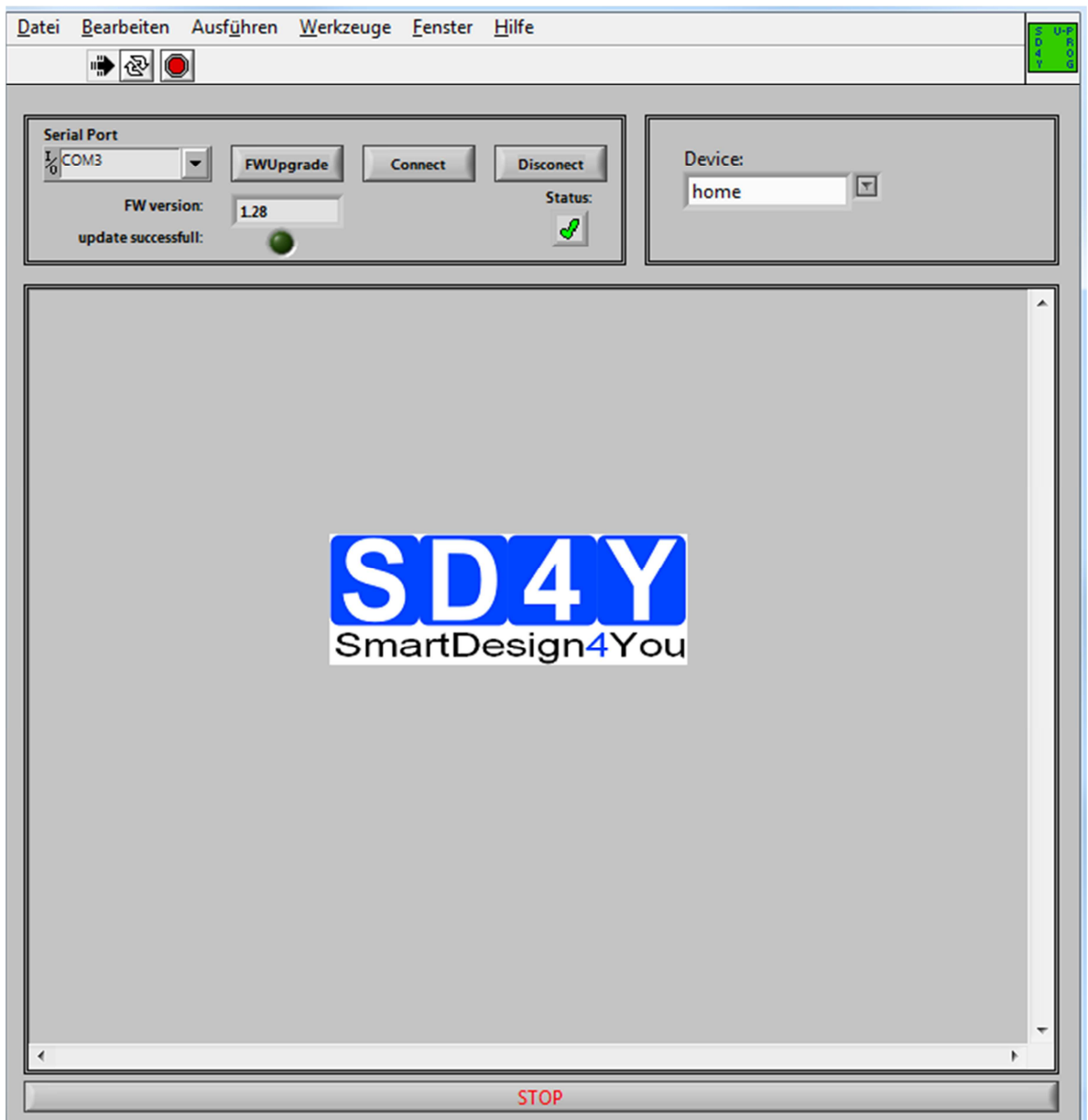

23) Choose the right COM Port



UPROG Programmer - Programming Procedure for ams AS5xxx series



24) Press the  Button. The Status will change to the green checkmark.

25) Please check if the latest firmware is used. For a firmware update, please connect the programmer to the USB , choose the right COM and press the FW upgrade Button

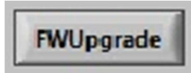

If the update was successful, the FW- Version will change.

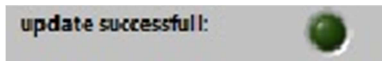

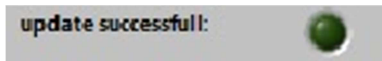
Additional the  marker will be green.

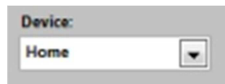

2) Choose the right Device  (AS5132)

3) The GUI will change to the right Device

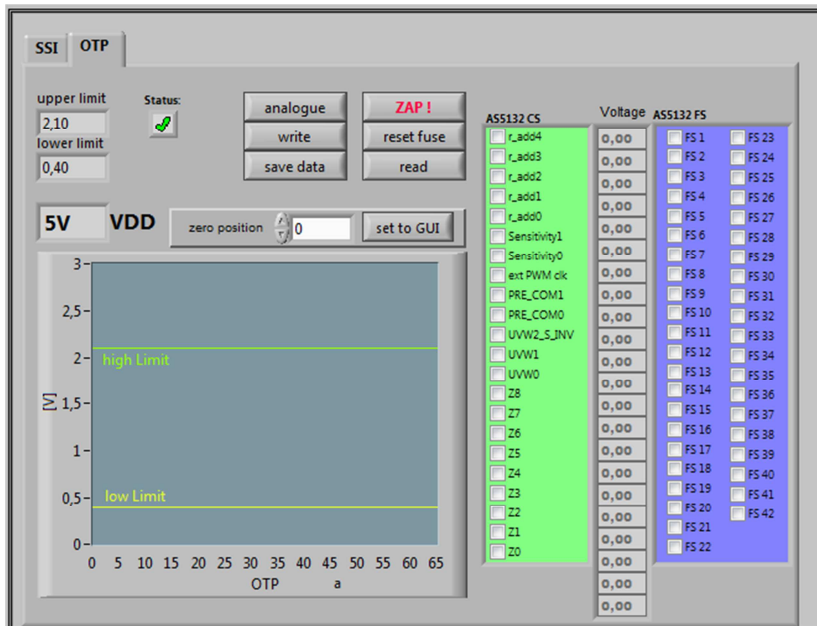

4) Set the VDD to the right Value

5) To use the **OTP TAB Area** first is important.

UPROG Programmer - Programming Procedure for ams AS5xxx series

6) SSI Tab : If a zero programming is necessary.

By selecting the SSI tab, information of the angular position and the status bits appear:

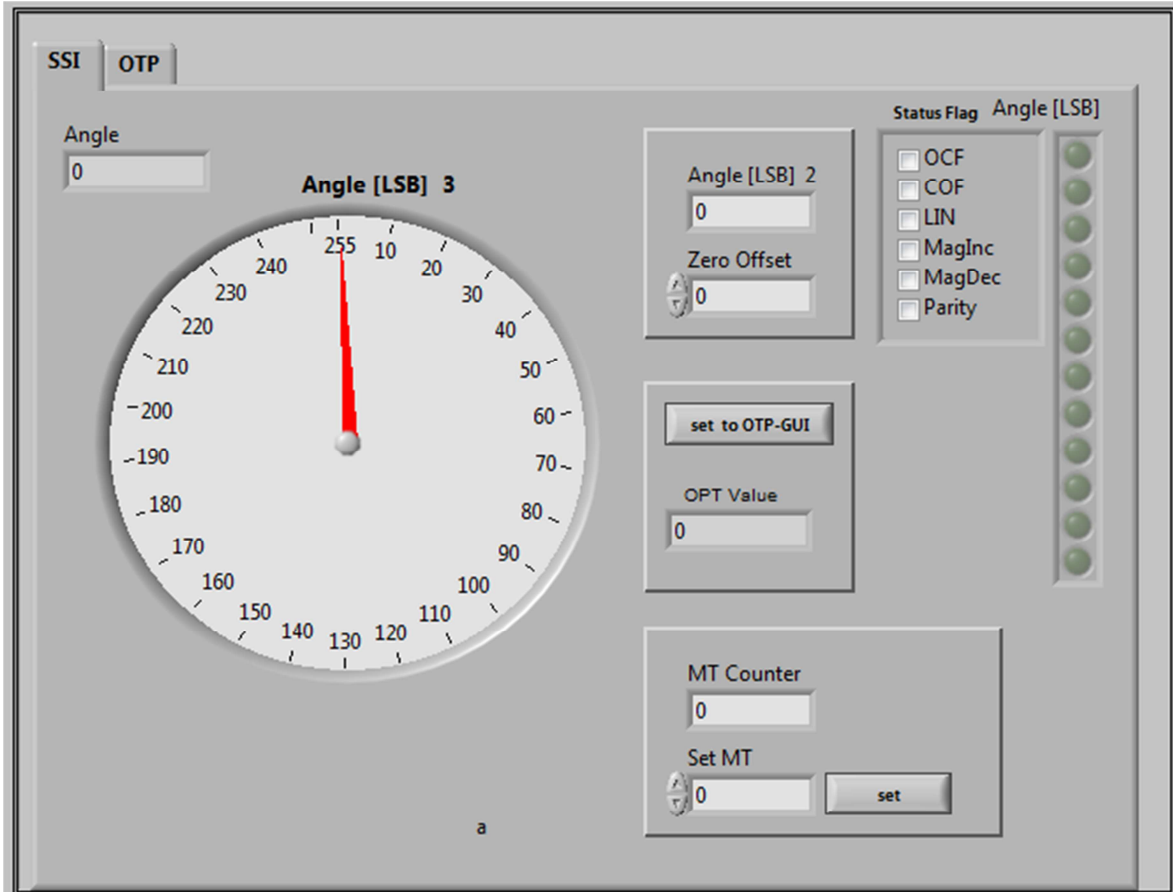

- SSI Graphic is showing the actual position of the magnet.
- Angle is showing the actual position of the magnet in LSB
- Status flag: The Status Flag displays the status bits extracted from the SSI.
- Set to OTP-GUI: The OTP Value is showing the Angle. With pushing the "Set to OTP-GUI" button the information of the OTP Value is stored in the AS5132CS area of the OTP Tab.
- zero offset can be add to the actual zero position
- MT Counter = digital multi counter . more information in the AMS AS5132 Datasheet

UPROG Programmer - Programming Procedure for ams AS5xxx series

- 7) Push the “set to OTP-GUI” for setting the zero point
- 8) **Switch to the OTP Area.**

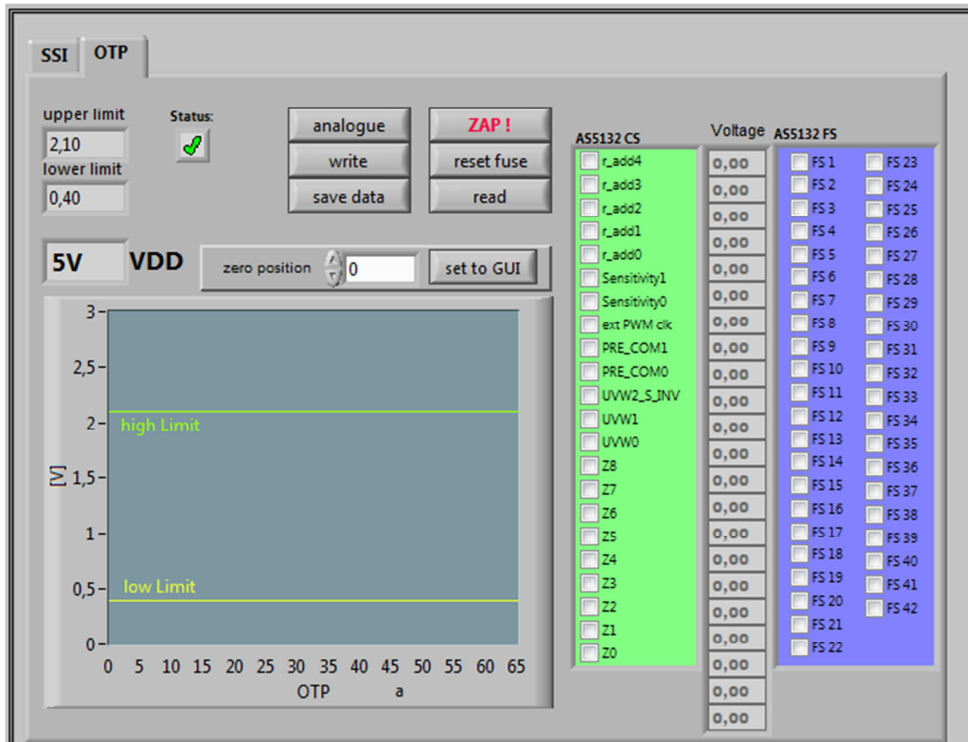

- 9) Select necessary Bits for programming in the **AS5132 CS** (Customer settings)

- 10) Push the write button

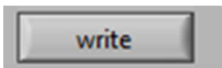

- 11) The OTP Write was successful.
- 12) Several writing is possible.

- 13) Push the read button

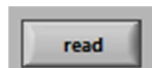

- 14) Several reading is possible

- 15) If the values in the AS5132 CS area are right, push



Button for permanent programming.

- 16) **Push Analogue. The analog read back is mandatory, after programming! Important: Analog Read Back for AS5132 is working with Hardware Revision 1.4 or higher**

UPROG Programmer - Programming Procedure for ams AS5xxx series

17) In the "Volt CS[V]" area is the OTP Fuse voltage Information of all Customer Bits.

Programmed Fuse: < 0,4 V

Unprogrammed Fuse: >2,1V

Bad Fuse: 0,4V – 2,1 V

If a bad fuse is detected the GUI will show an alert. A reprogramming of this bad fuse is not allowed.

18) Verification between written data and analogue data is mandatory; to be sure no bit is missing.

19) With Save Date , the Resistance values of the OTP will be stored in a TXT-file

8 Programming of the ams 1 Wire UART Sensors

8.1 AS5x6y programming procedure

AS5162 and AS5262 programming procedure is explained by an application note from ams AG. For programming the DUAL Die sensor and for calibration of the DAC the relay board is necessary. Also the GUI is written and programmed by ams AG, as an executable software and can be downloaded from www.ams.com

8.2 AS5403 programming procedure

AS5403 programming procedure is explained in an application note from ams AG. Also the GUI is written and programmed by ams AG as an executable software and can be downloaded from www.ams.com

9 Programming of the ams Sensors with standard interfaces

9.1 ams AS5147

9.1.1 Hardware

PINOUT: 20 PIN Connector to AS5147

Connector on the SD4Y Programmer

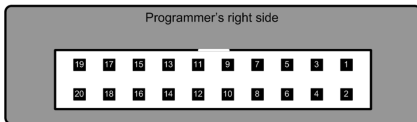

Pinout AS5147

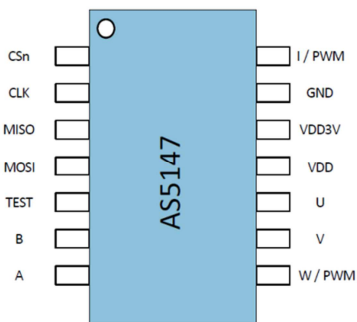

*copyright by ams 2014

Connection between SD4Y and AS5147

SD4Y Connector PinNr	AS5147 PinDescription
1	Prog
2	Prog
13	VSS
14	VSS
11	VDD
12	VDD
7	DO
17	CSn
20	CLK

9.1.2 Programming Procedure and Function Description for the ams AS5147

- 1) Start the GUI

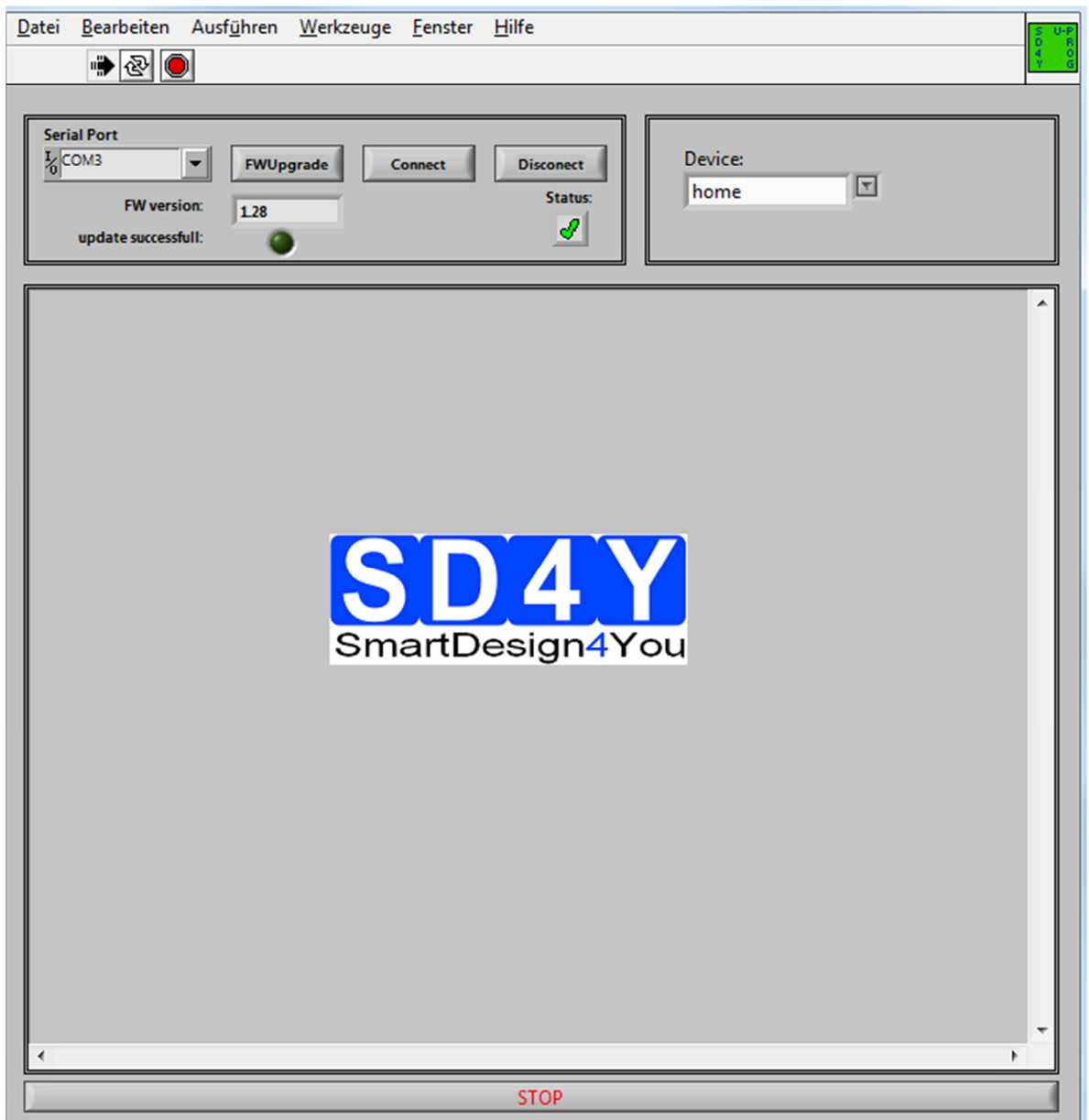

- 26) Choose the right COM Port



UPROG Programmer - Programming Procedure for ams AS5xxx series



27) Press the **Connect** Button. The Status will change to the green checkmark.

28) Please check if the latest firmware is used. For a firmware update, please connect the programmer to the USB , choose the right COM and press the FW upgrade Button

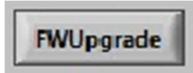

If the update was successful, the FW- Version will change.

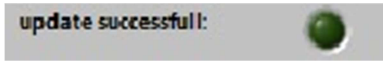

Additional the **update successful!** marker will be green.

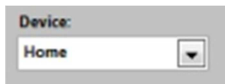

2) Choose the right Device **Home** (AS5147)

3) The GUI will change to the right Device

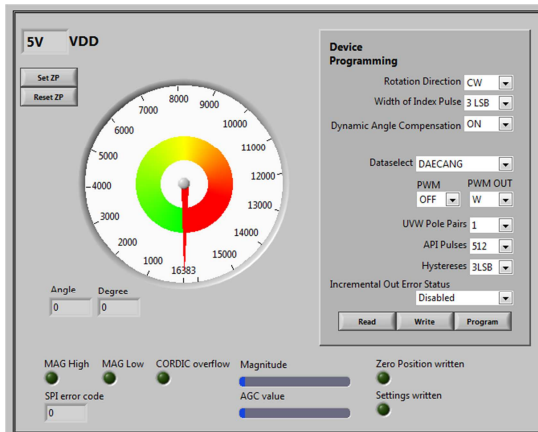

4) Set the VDD to the right Value

UPROG Programmer - Programming Procedure for ams AS5xxx series

- 5) Set Zero Point: SET ZP
- 6) Set Customer Settings:

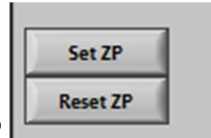

Device Programming

Rotation Direction

Width of Index Pulse

Dynamic Angle Compensation

Dataselect

PWM PWM OUT

UVW Pole Pairs

API Pulses

Hystereses

Incremental Out Error Status

- Rotation Direction (Clockwise, Counterclockwise)
- Index Pulse Programming (3LSB or 1LSB)
- Dynamic Angle Error Compensation (On/OFF)
- Dataselect: Angle on SPI Output
- PWM Setting: Turn ON and OFF
- PWM Out: Choosing W or I Pin for PWM Output
- UVV Pole Pairs: Up to 7 Pol Pairs
- ABI Pulse: ABI Pulses
- Hystereses
- Error Status: Enable, disable

UPROG Programmer - Programming Procedure for ams AS5xxx series

7) Select necessary Bits for programming in the **Device Programming** (Customer settings)

8) Push the write button

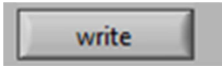

9) The OTP Write was successful.

10) Several writing is possible.

11) Push the read button

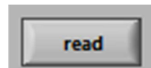

if a digital reading is necessary.

12) Several reading is possible

13) If the values are right, push

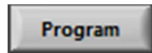

Button for permanent programming.

14) **If the programming and the internal procedure was correct, the programmer shows:
Programming successful:**

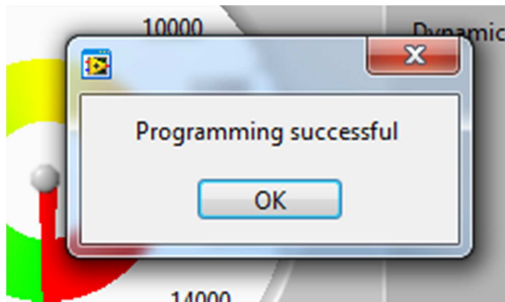

UPROG Programmer - Programming Procedure for ams AS5xxx series

9.2 ams AS5047D

9.2.1 Hardware

PINOUT: 20 PIN Connector to AS5047D

Connector on the SD4Y Programmer

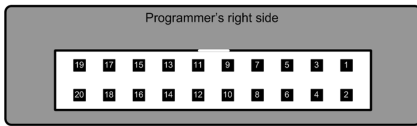

Pinout AS5047D

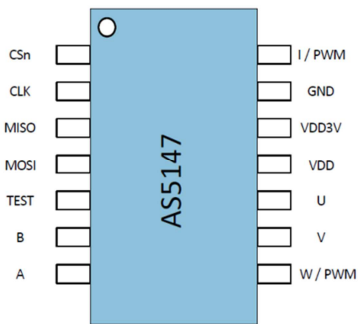

***copyright by ams 2014**

Connection between SD4Y and AS5047D

SD4Y Connector	AS5047D
PinNr	PinDescription
1	Prog
2	Prog
13	VSS
14	VSS
11	VDD
12	VDD
7	DO
17	CSn
20	CLK

9.2.2 Programming Procedure and Function Description for the ams AS5047D

1) Start the GUI

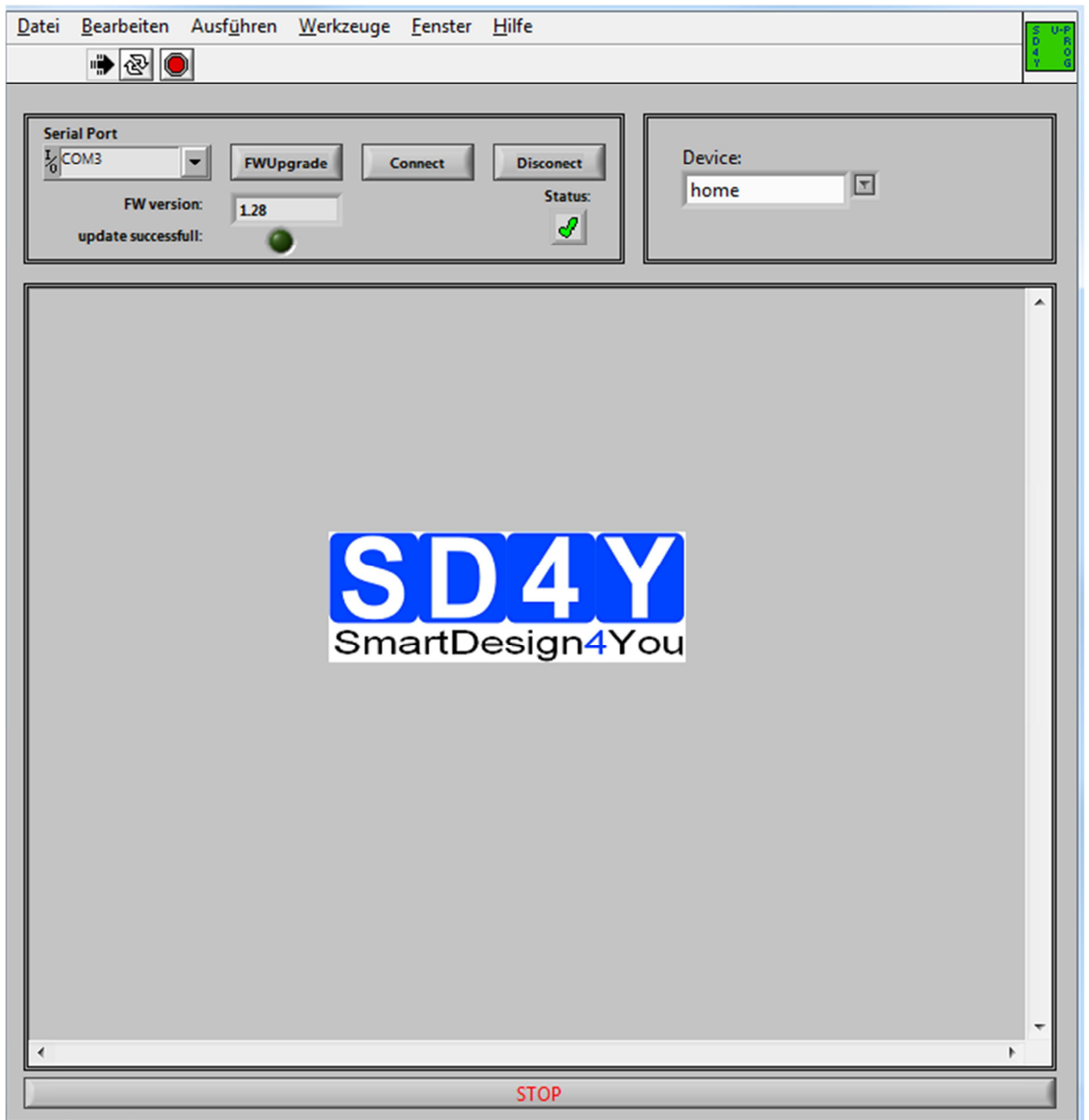

2) Choose the right COM Port

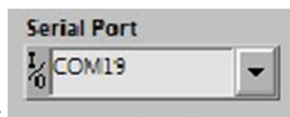

UPROG Programmer - Programming Procedure for ams AS5xxx series



- 3) Press the  Button. The Status will change to the green checkmark.
- 4) Please check if the latest firmware is used. For a firmware update, please connect the programmer to the USB , choose the right COM and press the FW upgrade Button



If the update was successful, the FW- Version will change.

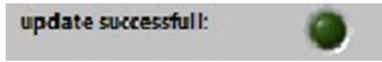

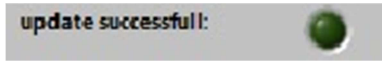
Additional the  marker will be green.

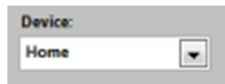

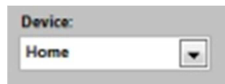
- 15) Choose the right Device  (AS5047D)
- 16) The GUI will change to the right Device

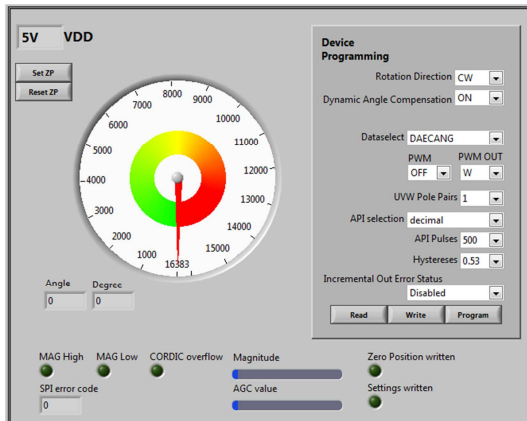

- 17) Set the VDD to the right Value

UPROG Programmer - Programming Procedure for ams AS5xxx series

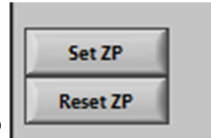

18) Set Zero Point: SET ZP

19) Set Customer Settings:

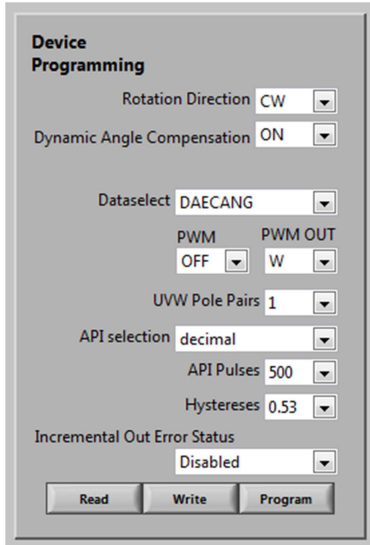

- Rotation Direction (Clockwise, Counterclockwise)
- Index Pulse Programming (3LSB or 1LSB)
- Dynamic Angle Error Compansation (On/OFF)
- Dataselect: Angle on SPI Output
- PWM Setting: Turn ON and OFF
- PWM Out: Choosing W or I Pin for PWM Output
- UVV Pole Pairs: Up to 7 Pol Pairs
- ABI Pulse: ABI Pulses
- Hystereses
- Error Status: Enable, disable

UPROG Programmer - Programming Procedure for ams AS5xxx series

20) Select necessary Bits for programming in the **Device Programming** (Customer settings)

21) Push the write button

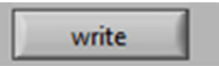

22) The OTP Write was successful.

23) Several writing is possible.

24) Push the read button

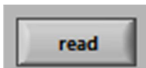

if a digital reading is necessary.

25) Several reading is possible

26) If the values are right, push

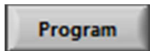

Button for permanent programming.

27) **If the programming and the internal procedure was correct, the programmer shows:
Programming successful:**

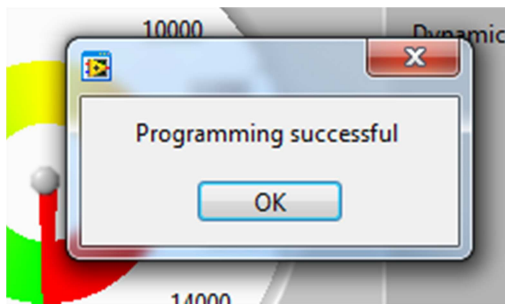

Copyright

Copyright © 2013 SD4Y

Disclaimer

Whilst every effort has been made to ensure that programming algorithms are correct at the time of their release, it is always possible that programming problems may be encountered, especially when new devices and their associated algorithms are initially released.

It's recommended that all users are doing the programmer check (hardware internal check and check for the analog read back) and always that a sample of a devices has been programmed correctly, before programming a large batch. Additional it's recommended to do the programmer check several times in the production.

SD4Y Ltd. can not be held responsible for any third party claims which arise out of the use of this programmer including 'consequential loss' and 'loss of profit'.

Additional SD4Y Ltd. cannot be held for any programming problems which are 'out of our control'

Contact Information

SD4Y