

Hi-Rel Slotted Optical Switches

Types OPB870N, OPB870L, OPB870P, OPB870T Series

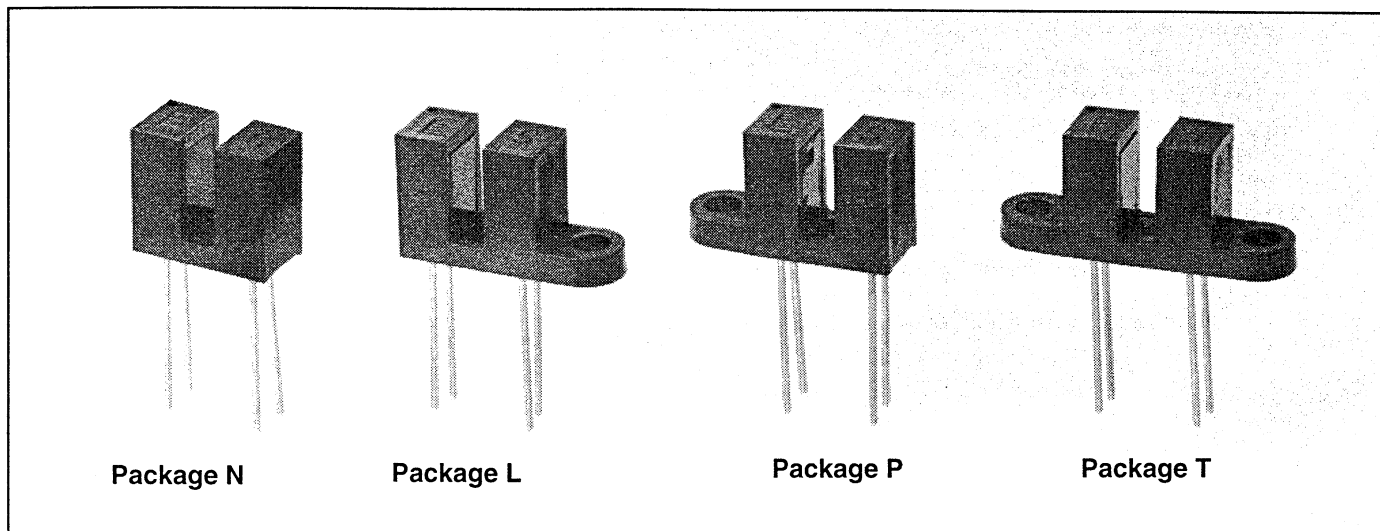

Features

- Non-contact switching
- Choice of apertures
- Choice of minimum $I_{C(ON)}$
- Hermetically sealed components
- Components processed to Optek's screening program patterned after MIL-PRF-19500 for TX and TXV devices
- S level processing available
- Plastic meets NASA publication 1124

Description

The OPB870 series slotted optical switch consists of a gallium aluminum arsenide LED and a silicon phototransistor soldered into a printed circuit board then mounted in a high temperature plastic housing on opposite sides of a 0.125 inch (3.18 mm) wide slot. Phototransistor switching takes place whenever an opaque object passes through the slot. Options include phototransistor aperture widths of 0.050 inches (1.27 mm) or 0.010 inches (0.25 mm) for high resolution positioning sensing.

The OPB870 hi-rel series uses optoelectronic components that have been processed and tested as either TX or TXV components per MIL-PRF-19500. Typical screening and lot acceptance tests are provided on page 13-4.

Absolute Maximum Ratings ($T_A = 25^\circ\text{C}$ unless otherwise noted)

Operating Temperature Range	-65° C to +125° C
Storage Temperature Range	-65° C to +150° C
Lead Soldering Temperature [1/16 inch (1.6 mm) from case 5 sec. with soldering iron]	240° C
Input Diode	
Forward DC Current	50 mA
Reverse Voltage	2.0 V
Power Dissipation	100 mW ⁽²⁾

Output Phototransistor

Collector-Emitter Voltage	50 V
Emitter-Collector Voltage	7.0 V
Power Dissipation	100 mW ⁽²⁾

Notes:

- (1) Duration can be extended to 10 sec. max. when flow soldering.
- (2) Derate linearly 1.00 mW/°C above 25° C.
- (3) Methanol or isopropanol are recommended as cleaning agents.

Part Number Guide

OPB 87X X 5X XX

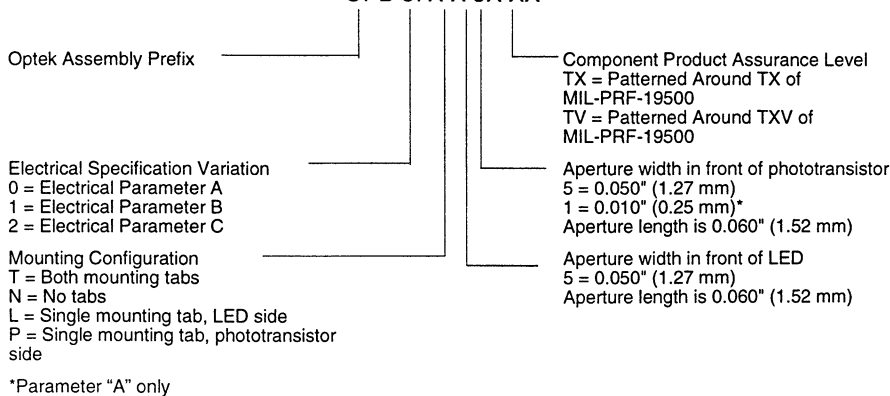

Type OPB870 Series

Electrical Characteristics ($T_A = 25^\circ\text{C}$ unless otherwise noted)

Symbol	Parameter	Min	Typ	Max	Units	Test Conditions		
Input Diode								
V_F	Forward Voltage ⁽⁴⁾	1.00	1.35	1.70	V	$I_F = 20.0\text{ mA}$		
		1.20	1.55	1.90	V	$I_F = 20.0\text{ mA}, T_A = -55^\circ\text{C}$		
		0.80	1.20	1.60	V	$I_F = 20.0\text{ mA}, T_A = 100^\circ\text{C}$		
I_R	Reverse Current		0.1	10	μA	$V_R = 2.0\text{ V}$		
Output Phototransistor								
$V_{(BR)CEO}$	Collector-Emitter Breakdown Voltage	50	110		V	$I_C = 1.0\text{ mA}, I_F = 0$		
$V_{(BR)ECO}$	Emitter-Collector Breakdown Voltage	7.0	10.0		V	$I_E = 100\ \mu\text{A}, I_F = 0$		
$I_{C(off)}$	Collector-Emitter Dark Current		0.2	100	nA	$V_{CE} = 10.0\text{ V}, I_F = 0$		
			10	100	μA	$V_{CE} = 10.0\text{ V}, I_F = 0, T_A = 100^\circ\text{C}$		
Coupled								
$I_{C(ON)}$	On-State Collector Current ⁽⁴⁾							
	Parameter A	OPB870	500			μA	$V_{CE} = 10.0\text{ V}, I_F = 20.0\text{ mA}$	
		OPB870	200			μA	$V_{CE} = 10.0\text{ V}, I_F = 20.0\text{ mA}, T_A = -55^\circ\text{C}$	
		OPB870	200			μA	$V_{CE} = 10.0\text{ V}, I_F = 20.0\text{ mA}, T_A = 100^\circ\text{C}$	
	Parameter B	OPB871	1000				μA	$V_{CE} = 5.0\text{ V}, I_F = 10.0\text{ mA}$
		OPB871	400				μA	$V_{CE} = 5.0\text{ V}, I_F = 10.0\text{ mA}, T_A = -55^\circ\text{C}$
		OPB871	400				μA	$V_{CE} = 5.0\text{ V}, I_F = 10.0\text{ mA}, T_A = 100^\circ\text{C}$
	Parameter C	OPB872	1800				μA	$V_{CE} = 0.4\text{ V}, I_F = 20.0\text{ mA}$
		OPB872	800				μA	$V_{CE} = 0.4\text{ V}, I_F = 20.0\text{ mA}, T_A = -55^\circ\text{C}$
		OPB872	800				μA	$V_{CE} = 0.4\text{ V}, I_F = 20.0\text{ mA}, T_A = 100^\circ\text{C}$
$V_{CE(SAT)}$	Collector-Emitter Saturation Voltage	OPB870		0.20	0.30	V	$I_C = 400\ \mu\text{A}, I_F = 20.0\text{ mA}$	
		OPB871		0.20	0.30	V	$I_C = 800\ \mu\text{A}, I_F = 10.0\text{ mA}$	
		OPB872		0.20	0.30	V	$I_C = 1800\ \mu\text{A}, I_F = 20.0\text{ mA}$	
t_r	Output Rise Time	OPB870		8.0	15.0	μs	$V_{CC} = 10.0\text{ V}, I_F = 20.0\text{ mA}, R_L = 1000\ \Omega$	
		OPB871		12.0	20.0	μs		
		OPB872		12.0	20.0	μs		
t_f	Output Fall Time	OPB870		8.0	15.0	μs	$V_{CC} = 10.0\text{ V}, I_F = 20.0\text{ mA}, R_L = 1000\ \Omega$	
		OPB871		12.0	20.0	μs		
		OPB872		12.0	20.0	μs		

(4) Measurement is taken during the last 500 μs of a single 1.0 ms test pulse. Heating due to increased pulse rate or pulse width can cause change in measurement results.

HI-REL OPTO COMPONENTS

Type OPB870 Series

Package Configuration T

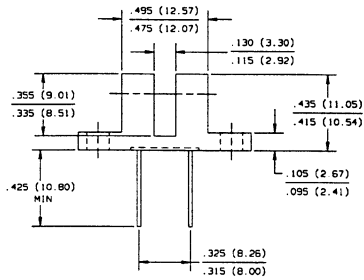
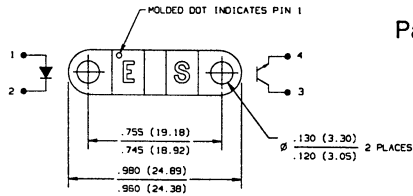

DIMENSIONS ARE IN INCHES (MILLIMETERS)

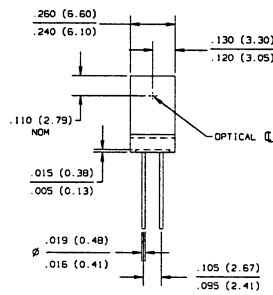

Package Configuration N

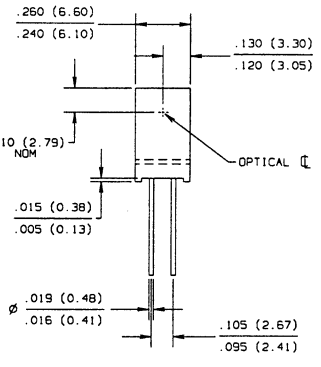
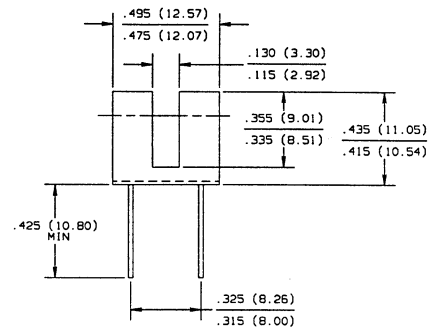
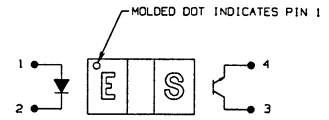

DIMENSIONS ARE IN INCHES (MILLIMETERS)

Package Configuration P

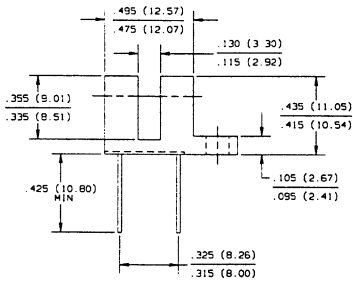
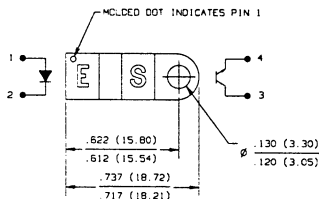

DIMENSIONS ARE IN INCHES (MILLIMETERS)

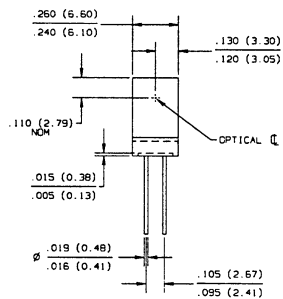

Package Configuration L

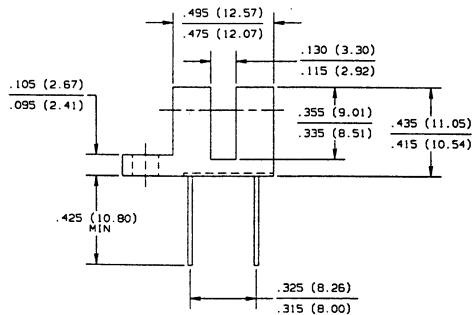
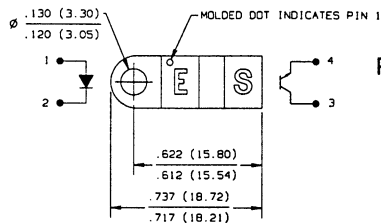

DIMENSIONS ARE IN INCHES (MILLIMETERS)

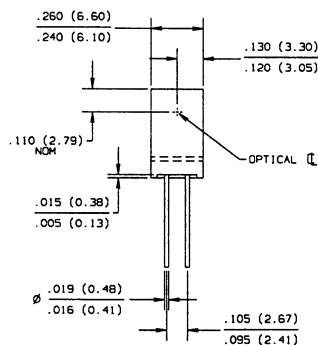

Type OPB870 Series

Typical Performance Curves

Relative Output Current vs Time

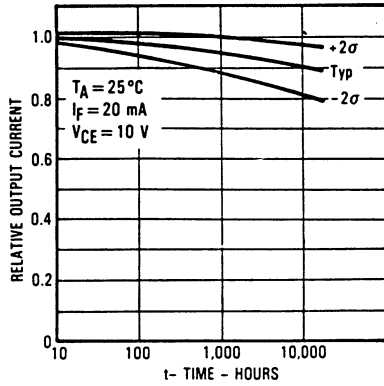

Normalized Output Current vs Ambient Temperature

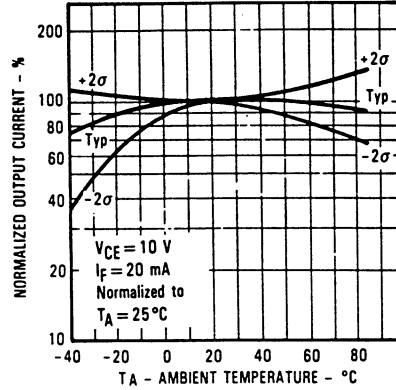

Reduction in Output Current Due to LED Heating vs Forward Current

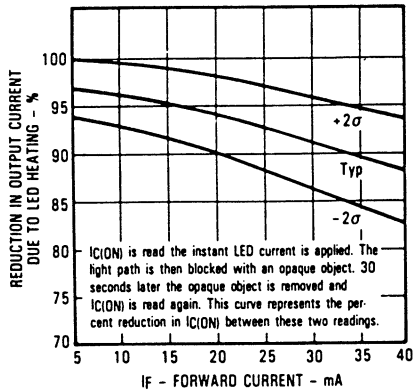

Normalized Output Current vs Input Current

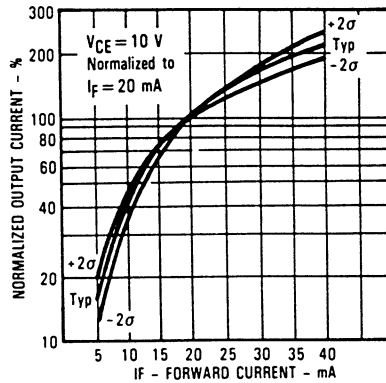

Rise and Fall Time vs Load Resistance

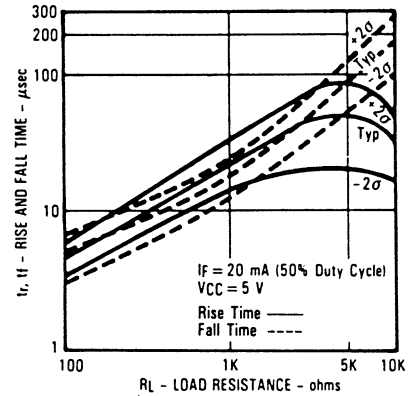

HI-RELIABLE OPTO COMPONENTS