

## **Not Recommended for New Designs**

---

The MAX909 was manufactured for Maxim by an outside wafer foundry using a process that is no longer available. It is not recommended for new designs. A Maxim replacement or an industry second-source may be available. The data sheet remains available for existing users. **The other parts on the following data sheet are not affected.**

For further information, please see the QuickView data sheet for this part or contact [technical support](#) for assistance.

# Dual/Quad/Single, High-Speed, Ultra-Low-Power, Single-Supply TTL Comparators

## General Description

The MAX907/MAX908/MAX909 are dual/quad/single, high-speed, ultra-low-power voltage comparators designed for use in systems powered from a single +5V supply; the MAX909 also accepts dual  $\pm 5V$  supplies. Their 40ns propagation delay (with 5mV input overdrive) is achieved with a power consumption of only 3.5mW per comparator. The wide input common-mode range extends from 200mV below ground (below the negative supply rail for the MAX909) to within 1.5V of the positive supply rail.

Because they are micropower, high-speed comparators that operate from a single +5V supply and include built-in hysteresis, these devices replace a variety of older comparators in a wide range of applications.

MAX907/MAX908/MAX909 outputs are TTL-compatible, requiring no external pullup circuitry. All inputs and outputs can be continuously shorted to either supply rail without damage. These easy-to-use comparators incorporate internal hysteresis to ensure clean output switching even when the devices are driven by a slow-moving input signal.

The MAX909 features complementary outputs and an output latch. A separate supply pin for extending the analog input range down to -5V is also provided.

The dual MAX907 and single MAX909 are available in 8-pin DIP and SO packages, and the quad MAX908 is available in 14-pin DIP and SO packages. These comparators are ideal for single +5V-supply applications that require the combination of high speed, precision, and ultra-low power dissipation.

## Applications

- Battery-Powered Systems
- High-Speed A/D Converters
- High-Speed V/F Converters
- Line Receivers
- Threshold Detectors/Discriminators
- High-Speed Sampling Circuits
- Zero-Crossing Detectors

## Features

- ◆ 40ns Propagation Delay
- ◆ 700 $\mu$ A (3.5mW) Supply Current per Comparator
- ◆ Single 4.5V to 5.5V Supply Operation (or  $\pm 5V$ , MAX909 only)
- ◆ Wide Input Range Includes Ground (or -5V, MAX909 only)
- ◆ Low, 500 $\mu$ V Offset Voltage
- ◆ Internal Hysteresis Provides Clean Switching
- ◆ TTL-Compatible Outputs (Complementary on MAX909)
- ◆ Input and Output Short-Circuit Protection
- ◆ Internal Latch (MAX909 only)

## Ordering Information

| PART          | TEMP RANGE      | PIN-PACKAGE   |
|---------------|-----------------|---------------|
| MAX907CPA     | 0°C to +70°C    | 8 Plastic DIP |
| MAX907CSA     | 0°C to +70°C    | 8 SO          |
| MAX907EPA     | -40°C to +85°C  | 8 Plastic DIP |
| MAX907ESA     | -40°C to +85°C  | 8 SO          |
| MAX907MSA/PR* | -55°C to +125°C | 8 SO          |

Ordering Information continued at end of data sheet.

\*Go to [www.maxim-ic.com/PR-1](http://www.maxim-ic.com/PR-1) for details on high-reliability plastic processing.

## Pin Configurations

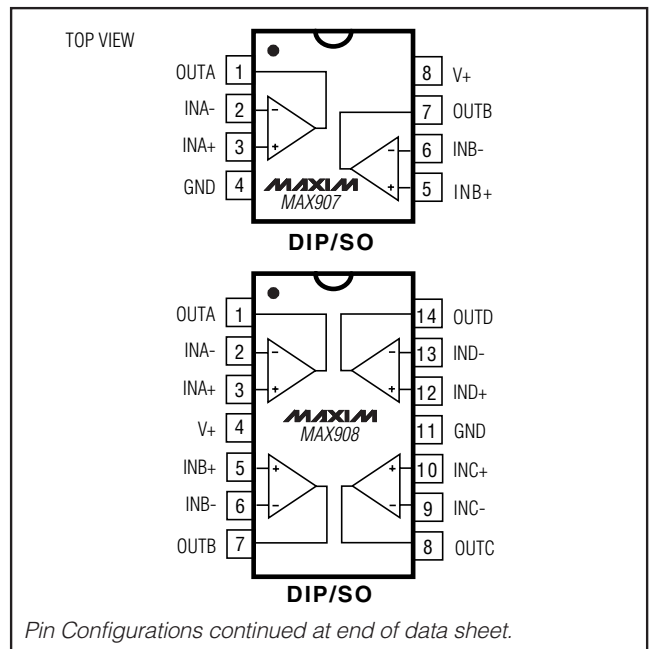

# Dual/Quad/Single, High-Speed, Ultra-Low-Power, Single-Supply TTL Comparators

## ABSOLUTE MAXIMUM RATINGS

|  |                            |  |                 |
|--|----------------------------|--|-----------------|
| Positive Supply Voltage (V+ to GND) .....              | +6V                        | Continuous Power Dissipation (T <sub>A</sub> = +70°C)  |                 |
| Negative Supply Voltage (V- to GND, MAX909 only) ..... | -7V                        | 8-Pin Plastic DIP (derate 9.09mW/°C above +70°C) ...   | 727mW           |
| Differential Input Voltage                             |                            | 8-Pin SO (derate 5.88mW/°C above +70°C) .....          | 471mW           |
| MAX907/MAX908 .....                                    | -0.3V to (V+ + 0.3V)       | 14-Pin Plastic DIP (derate 10.00mW/°C above +70°C) ... | 800mW           |
| MAX909 .....   | (V- - 0.3V) to (V+ + 0.3V) | 14-Pin SO (derate 8.33mW/°C above +70°C) .....         | 667mW           |
| Common-Mode Input Voltage                              |                            | Operating Temperature Ranges:                          |                 |
| MAX907/MAX908 .....                                    | -0.3V to (V+ + 0.3V)       | MAX90_C_ .....   | 0°C to +70°C    |
| MAX909 .....   | (V- - 0.3V) to (V+ + 0.3V) | MAX90_E_ .....   | -40°C to +85°C  |
| Latch Input Voltage (MAX909 only) .....                | -0.3V to (V+ + 0.3V)       | MAX907MSA/PR .....                                     | -55°C to +125°C |
| Input/Output Short-Circuit Duration to V+ or GND ...   | Continuous                 | Storage Temperature Range .....                        | -65°C to +150°C |
|  |                            | Lead Temperature (soldering, 10s) .....                | +300°C          |

Stresses beyond those listed under "Absolute Maximum Ratings" may cause permanent damage to the device. These are stress ratings only, and functional operation of the device at these or any other conditions beyond those indicated in the operational sections of the specifications is not implied. Exposure to absolute maximum rating conditions for extended periods may affect device reliability.

## ELECTRICAL CHARACTERISTICS

(V+ = 5V, T<sub>A</sub> = +25°C; MAX909 only: V- = 0V, V<sub>LATCH</sub> = 0V; unless otherwise noted.)

| PARAMETER                              | SYMBOL             | CONDITIONS  | MIN                   | TYP  | MAX      | UNITS |
|--|--------------------|---|-----------------------|------|----------|-------|
| Positive Trip Point                    | V <sub>TRIP+</sub> | (Note 1)  |                       | 2    | 4        | mV    |
| Negative Trip Point                    | V <sub>TRIP-</sub> | (Note 1)  |                       | -2   | -4       | mV    |
| Input Offset Voltage                   | V <sub>OS</sub>    | (Note 2)  |                       | 0.5  | 2.0      | mV    |
| Input Bias Current                     | I <sub>B</sub>     | V <sub>CM</sub> = 0V, V <sub>IN</sub> = V <sub>OS</sub> |                       | 100  | 300      | nA    |
| Input Offset Current                   | I <sub>OS</sub>    | V <sub>CM</sub> = 0V, V <sub>IN</sub> = V <sub>OS</sub> |                       | 25   | 50       | nA    |
| Input Voltage Range                    | V <sub>CMR</sub>   | (Notes 3, 4)  | MAX907/MAX908/MAX909  | -0.2 | V+ - 1.5 | V     |
|  |                    |   | MAX909 only: V- = -5V | -5.2 | V+ - 1.5 |       |
| Common-Mode Rejection Ratio            | CMRR               | (Notes 4, 5)  |                       | 50   | 150      | μV/V  |
| Power-Supply Rejection Ratio           | PSRR               | (Notes 4, 6)  |                       | 50   | 200      | μV/V  |
| Output High Voltage                    | V <sub>OH</sub>    | I <sub>SOURCE</sub> = 100μA                             | 3.0                   | 3.5  |          | V     |
| Output Low Voltage                     | V <sub>OL</sub>    | I <sub>SINK</sub> = 3.2mA                               |                       | 0.36 | 0.475    | V     |
|  |                    | I <sub>SINK</sub> = 8mA                                 |                       | 0.4  |          |       |
| Positive Supply Current per Comparator | I+                 | (Note 7)  | MAX907/MAX908         | 0.7  | 1.0      | mA    |
|  |                    |   | MAX909                | 1.2  | 1.8      |       |
| Negative Supply Current                | I-                 | MAX909 only: V- = -5V                                   |                       | 60   | 100      | μA    |
| Power Dissipation per Comparator       | PD                 | (Note 8)  | MAX907/MAX908         | 3.5  | 5.5      | mW    |
|  |                    |   | MAX909                | 6    | 10       |       |
| Output Rise Time                       | t <sub>r</sub>     | V <sub>OUT</sub> = 0.4V to 2.4V, C <sub>L</sub> = 10pF  |                       | 12   |          | ns    |
| Output Fall Time                       | t <sub>f</sub>     | V <sub>OUT</sub> = 2.4V to 0.4V, C <sub>L</sub> = 10pF  |                       | 6    |          | ns    |

# Dual/Quad/Single, High-Speed, Ultra-Low-Power, Single-Supply TTL Comparators

## ELECTRICAL CHARACTERISTICS (continued)

(V<sub>+</sub> = 5V, T<sub>A</sub> = +25°C; MAX909 only: V<sub>-</sub> = 0V, V<sub>LATCH</sub> = 0V; unless otherwise noted.)

| PARAMETER                      | SYMBOL                              | CONDITIONS  | MIN | TYP | MAX | UNITS |
|--------------------------------|-------------------------------------|---|-----|-----|-----|-------|
| Propagation Delay              | t <sub>PD+</sub> , t <sub>PD-</sub> | V <sub>IN</sub> = 100mV, V <sub>OD</sub> = 5mV (Note 9)               |     | 40  | 50  | ns    |
| Differential Propagation Delay | Δt <sub>PD</sub>                    | V <sub>IN</sub> = 100mV, V <sub>OD</sub> = 5mV (Note 10)              |     | 1   |     | ns    |
| Propagation Delay Skew         | t <sub>PDskew</sub>                 | MAX909 only: V <sub>IN</sub> = 100mV, V <sub>OD</sub> = 5mV (Note 11) |     | 2   |     | ns    |
| Latch Input Voltage High       | V <sub>IH</sub>                     | (Note 12)   | 2.0 |     |     | V     |
| Latch Input Voltage Low        | V <sub>IL</sub>                     | (Note 12)   |     |     | 0.8 | V     |
| Latch Input Current            | I <sub>IH</sub> , I <sub>IL</sub>   | (Note 12)   |     |     | 20  | μA    |
| Latch Setup Time               | t <sub>s</sub>                      | (Note 12)   |     | 2   |     | ns    |
| Latch Hold Time                | t <sub>h</sub>                      | (Note 12)   |     | 2   |     | ns    |

## ELECTRICAL CHARACTERISTICS

(V<sub>+</sub> = 5V, T<sub>A</sub> = T<sub>MIN</sub> to T<sub>MAX</sub>; MAX909 only: V<sub>-</sub> = 0V, V<sub>LATCH</sub> = 0V; unless otherwise noted.)

| PARAMETER                              | SYMBOL             | CONDITIONS  |                                   | MIN  | TYP | MAX                  | UNITS |
|--|--------------------|---|-----------------------------------|------|-----|----------------------|-------|
| Positive Trip Point                    | V <sub>TRIP+</sub> | (Note 1)  |                                   |      | 2   | 5                    | mV    |
| Negative Trip Point                    | V <sub>TRIP-</sub> | (Note 1)  |                                   |      | -2  | -5                   | mV    |
| Input Offset Voltage                   | V <sub>OS</sub>    | (Note 2)  |                                   |      | 1   | 3.5                  | mV    |
| Input Bias Current                     | I <sub>B</sub>     | V <sub>CM</sub> = 0V, V <sub>IN</sub> = V <sub>OS</sub> |                                   |      | 200 | 500                  | nA    |
| Input Offset Current                   | I <sub>OS</sub>    | V <sub>CM</sub> = 0V, V <sub>IN</sub> = V <sub>OS</sub> |                                   |      | 50  | 100                  | nA    |
| Input Voltage Range                    | V <sub>CMR</sub>   | C/E temp. ranges (Notes 3, 4)                           | MAX907/MAX908/MAX909              | -0.2 |     | V <sub>+</sub> - 1.5 | V     |
|  |                    |   | MAX909 only, V <sub>-</sub> = -5V | -5.2 |     | V <sub>+</sub> - 1.5 |       |
|  |                    | M temp. range (Notes 3, 4)                              | MAX907MSA/PR                      | -0.1 |     | V <sub>+</sub> - 1.5 |       |
| Common-Mode Rejection Ratio            | CMRR               | (Notes 4, 5)  |                                   |      | 75  | 300                  | μV/V  |
| Power-Supply Rejection Ratio           | PSRR               | (Notes 4, 6)  |                                   |      | 75  | 400                  | μV/V  |
| Output High Voltage                    | V <sub>OH</sub>    | I <sub>SOURCE</sub> = 100μA                             |                                   | 2.8  | 3.5 |                      | V     |
| Output Low Voltage                     | V <sub>OL</sub>    | I <sub>SINK</sub> = 3.2mA                               | T <sub>A</sub> = T <sub>MAX</sub> |      |     | 0.45                 | V     |
|  |                    |   | T <sub>MIN</sub> = 0°C            |      |     | 0.525                |       |
|  |                    |   | T <sub>MIN</sub> = -40°C          |      |     | 0.550                |       |
| Positive Supply Current per Comparator | I <sub>+</sub>     | (Note 7)  | MAX907/MAX908                     |      | 0.8 | 1.2                  | mA    |
|  |                    |   | MAX909                            |      | 1.2 | 2.0                  |       |
| Negative Supply Current                | I <sub>-</sub>     | MAX909 only; V <sub>-</sub> = -5V                       |                                   |      | 100 | 200                  | μV    |
| Power Dissipation per Comparator       | PD                 | (Note 8)  | MAX907/MAX908                     |      | 4   | 7                    | mW    |
|  |                    |   | MAX909                            |      | 6   | 11                   |       |

# Dual/Quad/Single, High-Speed, Ultra-Low-Power, Single-Supply TTL Comparators

## ELECTRICAL CHARACTERISTICS (continued)

( $V_+ = 5V$ ,  $T_A = T_{MIN}$  to  $T_{MAX}$ ; MAX909 only:  $V_- = 0V$ ,  $V_{LATCH} = 0V$ ; unless otherwise noted.)

| PARAMETER                      | SYMBOL                | CONDITIONS  | MIN | TYP | MAX | UNITS   |
|--------------------------------|-----------------------|---|-----|-----|-----|---------|
| Propagation Delay              | $t_{PD+}$ , $t_{PD-}$ | $V_{IN} = 100mV$ , $V_{OD} = 5mV$<br>(Note 9)               |     | 45  | 70  | ns      |
| Differential Propagation Delay | $\Delta t_{PD}$       | $V_{IN} = 100mV$ , $V_{OD} = 5mV$<br>(Note 10)              |     | 2   |     | ns      |
| Propagation Delay Skew         | $t_{PDskew}$          | MAX909 only: $V_{IN} = 100mV$ ,<br>$V_{OD} = 5mV$ (Note 11) |     | 4   |     | ns      |
| Latch Input Voltage High       | $V_{IH}$              | (Note 12)   | 2.0 |     |     | V       |
| Latch Input Voltage Low        | $V_{IL}$              | (Note 12)   |     |     | 0.8 | V       |
| Latch Input Current            | $I_{IH}$ , $I_{IL}$   | (Note 12)   |     |     | 20  | $\mu A$ |
| Latch Setup Time               | $t_s$                 | (Note 12)   |     | 4   |     | ns      |
| Latch Hold Time                | $t_h$                 | (Note 12)   |     | 4   |     | ns      |

- Note 1:** Trip Point is defined as the input voltage required to make the comparator output change state. The difference between upper ( $V_{TRIP+}$ ) and lower ( $V_{TRIP-}$ ) trip points is equal to the width of the input-referred hysteresis zone ( $V_{HYST}$ ). Specified for an input common-mode voltage ( $V_{CM}$ ) of 0V (see Figure 1).
- Note 2:** Input Offset Voltage is defined as the center of the input-referred hysteresis zone. Specified for  $V_{CM} = 0V$  (see Figure 1).
- Note 3:** Inferred from the CMRR test. Note that a correct logic result is obtained at the output, provided that at least one input is within the  $V_{CMR}$  limits. Note also that either or both inputs can be driven to the upper or lower absolute maximum limit without damage to the part.
- Note 4:** Tested with  $V_+ = 5.5V$  (and  $V_- = 0V$  for MAX909). MAX909 also tested over the full analog input range (i.e., with  $V_- = -5.5V$ ).
- Note 5:** Tested over the full input voltage range ( $V_{CMR}$ ).
- Note 6:** Specified over the full tolerance of operating supply voltage: MAX907/MAX908 tested with  $4.5V < V_+ < 5.5V$ . MAX909 tested with  $4.5V < V_+ < 5.5V$  and with  $-5.5V < V_- < 0V$ .
- Note 7:** Positive Supply Current specified with the worst-case condition of all outputs at logic low (MAX907/MAX908), and with  $V_+ = 5.5V$ .
- Note 8:** Typical power specified with  $V_+ = 5V$ ; maximum with  $V_+ = 5.5V$  (and with  $V_- = -5.5V$  for MAX909).
- Note 9:** Due to difficulties in measuring propagation delay with 5mV of overdrive in automatic test equipment, this parameter is guaranteed by design for the MAX907 and MAX908. Correlation tests show that the specification can be guaranteed if all other DC parameters are within the specified limits.  $V_{OS}$  must be added to the overdrive voltage for low values of overdrive. For the MAX909, propagation delay is typical only and there is no guaranteed maximum limit.
- Note 10:** Differential Propagation Delay is specified as the difference between any two channels in the MAX907/MAX908 (both outputs making either a low-to-high or a high-to-low transition).
- Note 11:** Propagation Delay Skew is specified as the difference between any single channel's output low-to-high transition ( $t_{PD+}$ ) and high-to-low transition ( $t_{PD-}$ ), and also between the QOUT and  $\bar{Q}$ OUT transition on the MAX909.
- Note 12:** Latch specifications apply to MAX909 only (see Figure 2).

# Dual/Quad/Single, High-Speed, Ultra-Low-Power, Single-Supply TTL Comparators

## Typical Operating Characteristics

( $V_{+} = 5V$ ,  $T_A = +25^{\circ}C$ , unless otherwise noted.)

MAX907/MAX908/MAX909

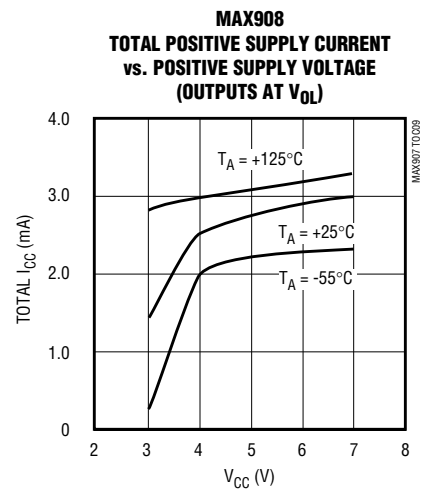
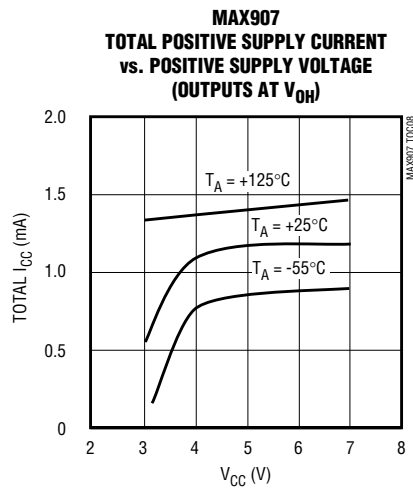
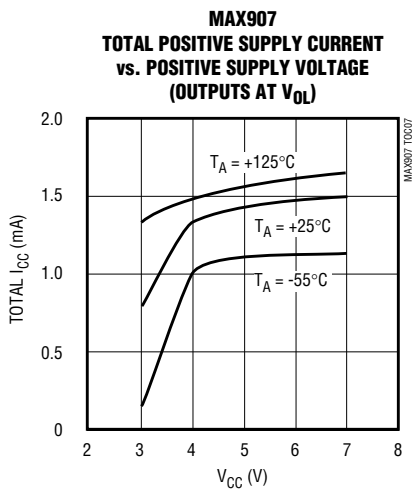
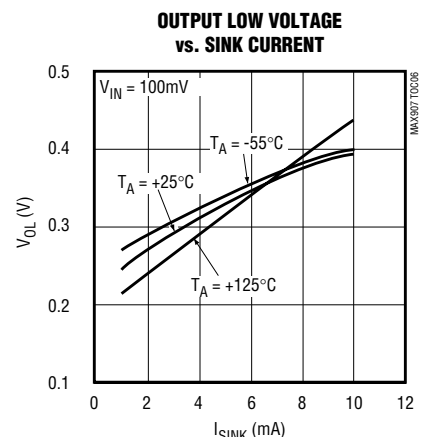
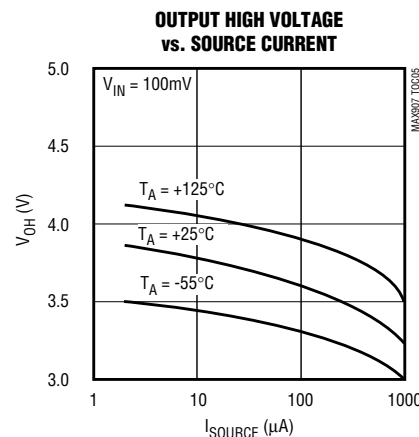
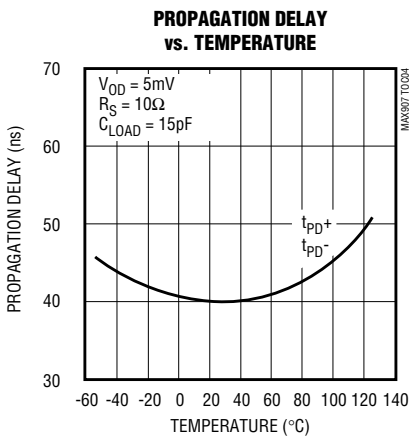
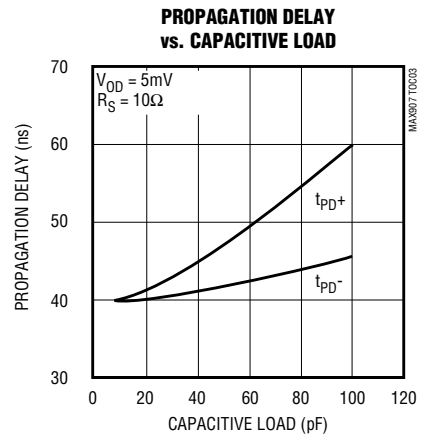
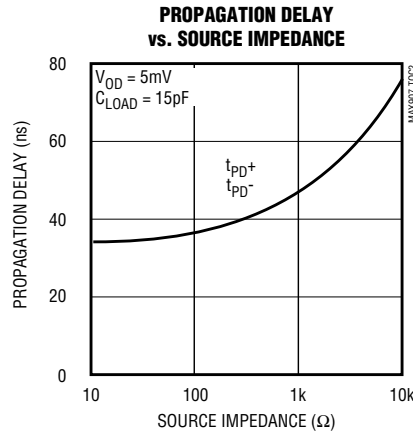
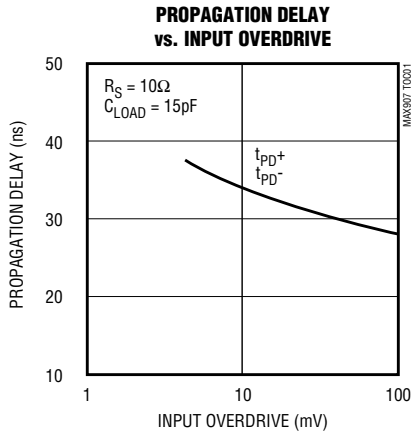

# Dual/Quad/Single, High-Speed, Ultra-Low-Power, Single-Supply TTL Comparators

## Typical Operating Characteristics (continued)

( $V_+ = 5V$ ,  $T_A = +25^\circ C$ , unless otherwise noted.)

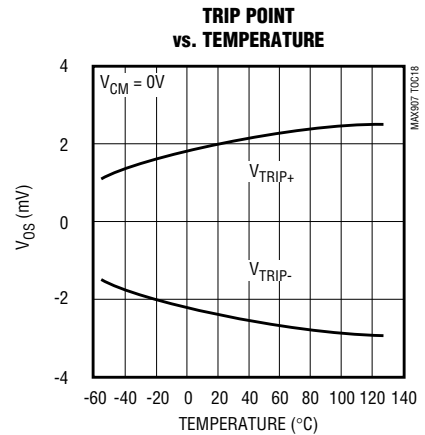
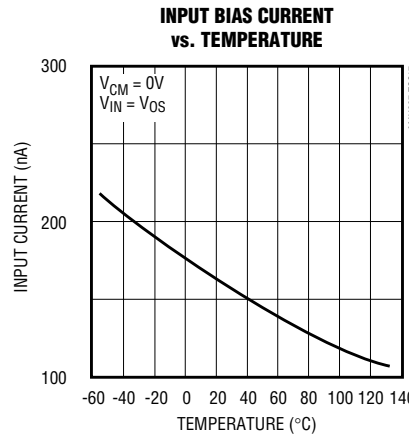
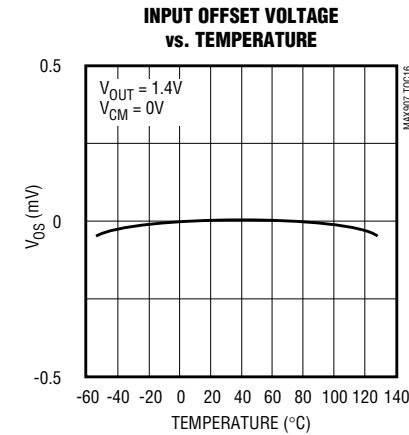
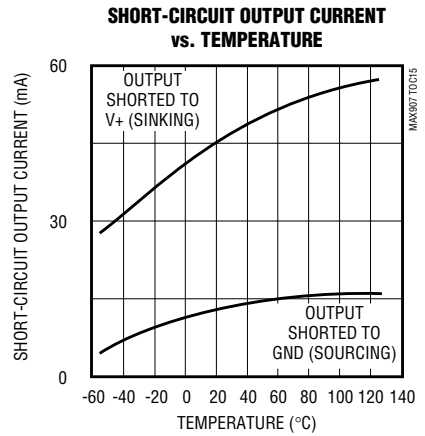
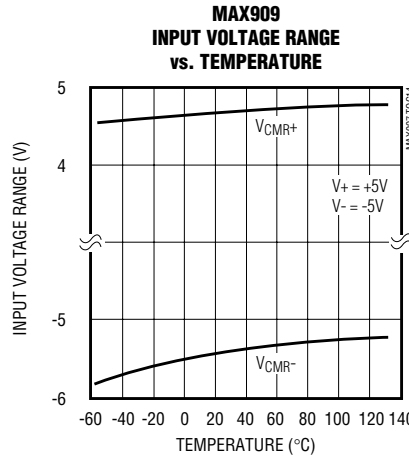
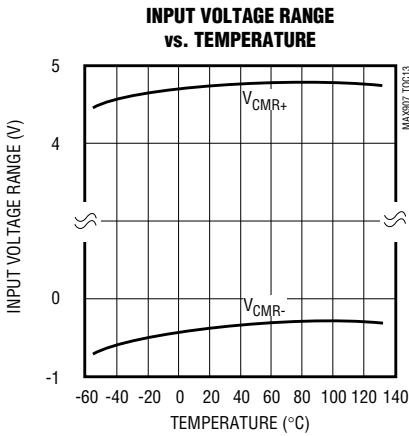
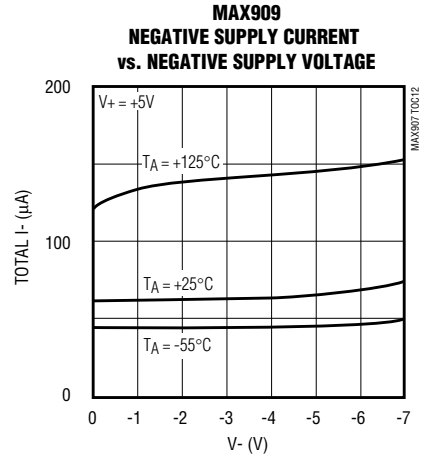
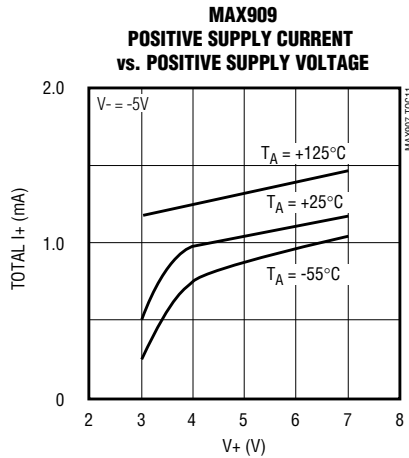
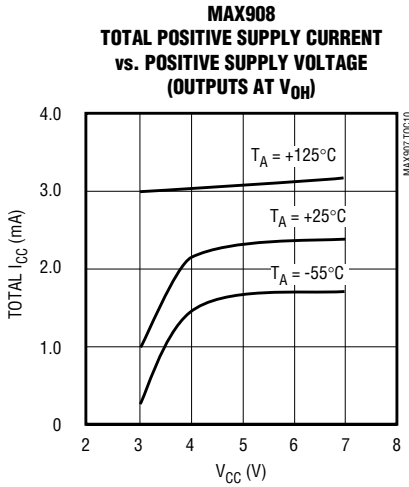

# Dual/Quad/Single, High-Speed, Ultra-Low-Power, Single-Supply TTL Comparators

## Typical Operating Characteristics (continued)

(V+ = 5V, T<sub>A</sub> = +25°C, unless otherwise noted.)

**MAX907/MAX908**  
**PROPAGATION DELAY (t<sub>PD+</sub>)**  
**(5mV OVERDRIVE)**

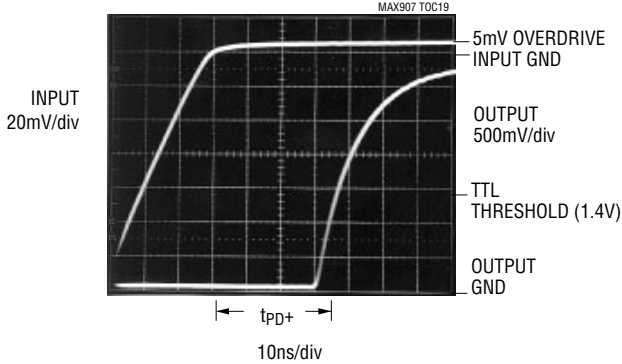

**MAX907/MAX908**  
**PROPAGATION DELAY (t<sub>PD-</sub>)**  
**(5mV OVERDRIVE)**

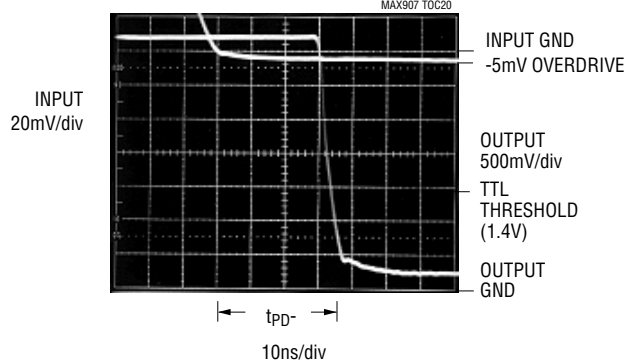

**MAX909**  
**PROPAGATION DELAY (t<sub>PD+</sub>)**  
**(5mV OVERDRIVE)**

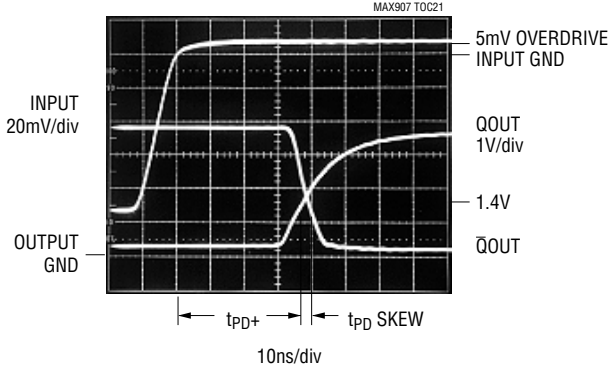

**MAX909**  
**PROPAGATION DELAY (t<sub>PD-</sub>)**  
**(5mV OVERDRIVE)**

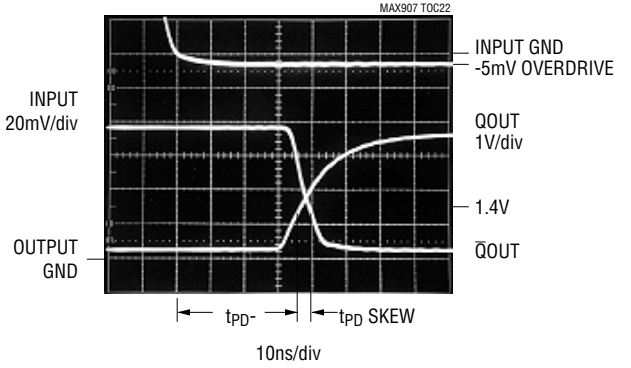

**RESPONSE TO 10MHz SINE WAVE**

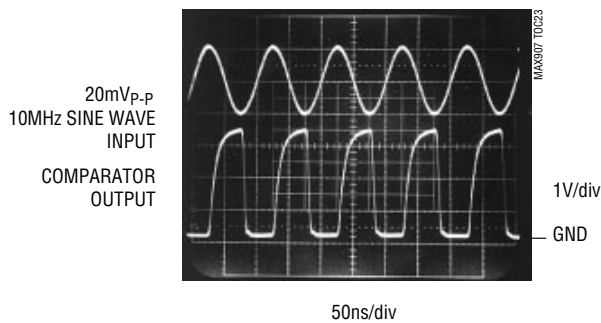



# Dual/Quad/Single, High-Speed, Ultra-Low-Power, Single-Supply TTL Comparators

## Pin Description

| PIN    |        |        | NAME               | FUNCTION  |
|--------|--------|--------|--------------------|---|
| MAX907 | MAX908 | MAX909 |                    |   |
| 1      | 1      | —      | OUTA               | Comparator A Output   |
| 2      | 2      | —      | INA-               | Comparator A Inverting Input  |
| 3      | 3      | —      | INA+               | Comparator A Noninverting Input   |
| 4      | 11     | 6      | GND                | Ground  |
| 5      | 5      | —      | INB+               | Comparator B Noninverting Input   |
| 6      | 6      | —      | INB-               | Comparator B Inverting Input  |
| 7      | 7      | —      | OUTB               | Comparator B Output   |
| 8      | 4      | 1      | V+                 | Positive Supply   |
| —      | 8      | —      | OUTC               | Comparator C Output   |
| —      | 9      | —      | INC-               | Comparator C Inverting Input  |
| —      | 10     | —      | INC+               | Comparator C Noninverting Input   |
| —      | 12     | —      | IND+               | Comparator D Noninverting Input   |
| —      | 13     | —      | IND-               | Comparator D Inverting Input  |
| —      | 14     | —      | OUTD               | Comparator D Output   |
| —      | —      | 2      | IN+                | Noninverting Input  |
| —      | —      | 3      | IN-                | Inverting Input   |
| —      | —      | 4      | V-                 | Negative Supply or Ground   |
| —      | —      | 5      | LE                 | The latch is transparent when LE is low. The comparator output is stored when LE is high. |
| —      | —      | 7      | QOUT               | Comparator Output   |
| —      | —      | 8      | $\overline{Q}$ OUT | Inverted Comparator Output  |

## Detailed Description

### Timing

Noise or undesired parasitic AC feedback cause most high-speed comparators to oscillate in the linear region (i.e., when the voltage on one input is at or near the voltage on the other input). The MAX907/MAX908/MAX909 eliminate this problem by incorporating internal hysteresis. When the two comparator input voltages are equal, hysteresis effectively causes one comparator input voltage to move quickly past the other, thus taking the input out of the region where oscillation occurs. Standard comparators require that hysteresis be added through the use of external resistors. The MAX907/MAX908/MAX909's fixed internal hysteresis eliminates these resistors (and the equations required to determine appropriate values).

Adding hysteresis to a comparator creates two trip points: one for the input voltage rising and one for the input voltage falling (Figure 1). The difference between these two input-referred trip points is the hysteresis.

Figure 1 illustrates the case where IN- is fixed and IN+ is varied. If the inputs were reversed, the figure would look the same, except the output would be inverted.

The MAX909 includes an internal latch, allowing the result of a comparison to be stored. If LE is low, the latch is transparent (i.e., the comparator operates as though the latch is not present). The state of the comparator output is stored when LE is high (Figure 2).

Note that the MAX909 can be operated with V- connected to ground or to a negative supply voltage. The MAX909's input range extends from (V- - 0.2V) to (V+ - 1.5V).

# Dual/Quad/Single, High-Speed, Ultra-Low-Power, Single-Supply TTL Comparators

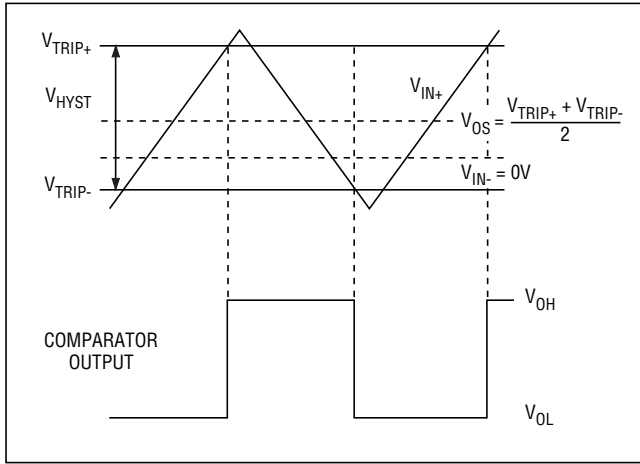

Figure 1. Input and Output Waveforms, Noninverting Input Varied

## Applications Information

### Circuit Layout

Because of the MAX907/MAX908/MAX909's high gain bandwidth, special precautions must be taken to realize the full high-speed capability. A printed circuit board with a good, low-inductance ground plane is mandatory. Place the decoupling capacitor (a 0.1µF ceramic capacitor is a good choice) as close to V+ as possible. Pay close attention to the decoupling capacitor's bandwidth, keeping leads short. Short lead lengths on the inputs and outputs are also essential to avoid unwanted parasitic feedback around the comparators. Solder the device directly to the printed circuit board instead of using a socket.

### Overdriving the Inputs

The inputs to the MAX907/MAX908/MAX909 may be driven beyond the voltage limits given in the *Absolute Maximum Ratings*, as long as the current flowing into the device is limited to 25mA. However, if the inputs are overdriven, the output may be inverted. The addition of an external diode prevents this inversion by limiting the input voltage to 200mV to 300mV below ground (Figure 3).

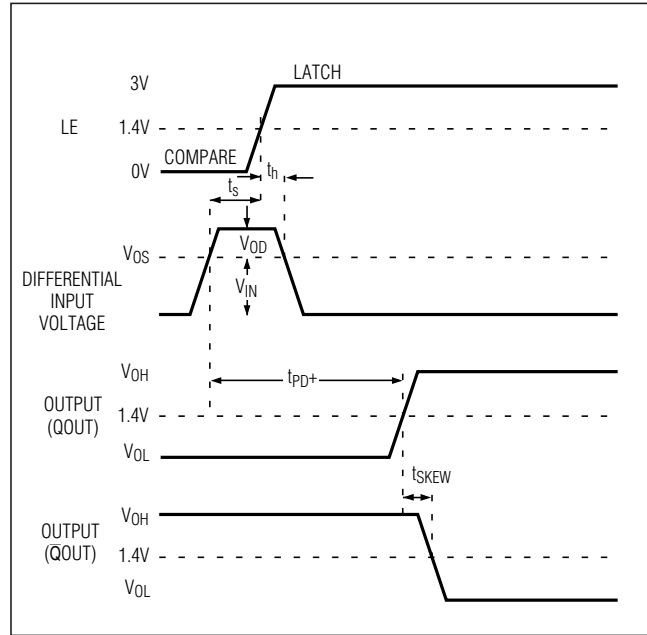

Figure 2. MAX909 Timing Diagram

### Battery-Operated Infrared Data Link

Figure 4's circuit allows reception of infrared data. The MAX403 converts the photodiode current to a voltage, and the MAX907 determines whether the amplifier output is high enough to be called a "1". The current consumption of this circuit is minimal: The MAX403 and MAX907 require typically 250µA and 700µA, respectively.

# Single/Dual/Quad, High-Speed, Ultra-Low-Power, Single-Supply TTL Comparators

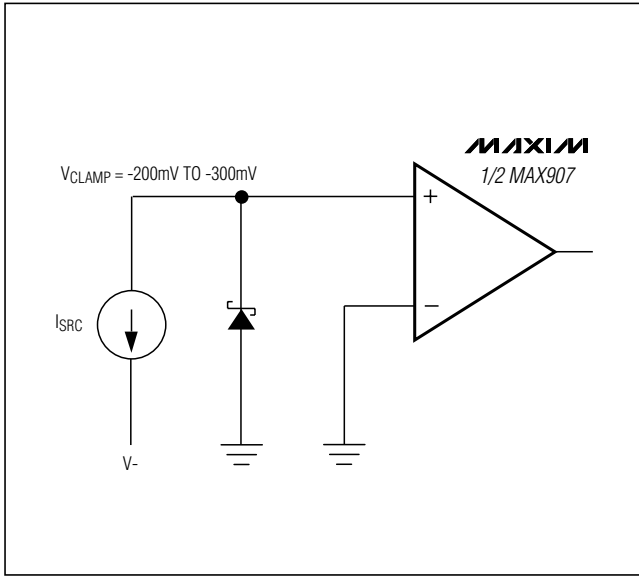

Figure 3. Schottky Clamp for Input Driven Below Ground

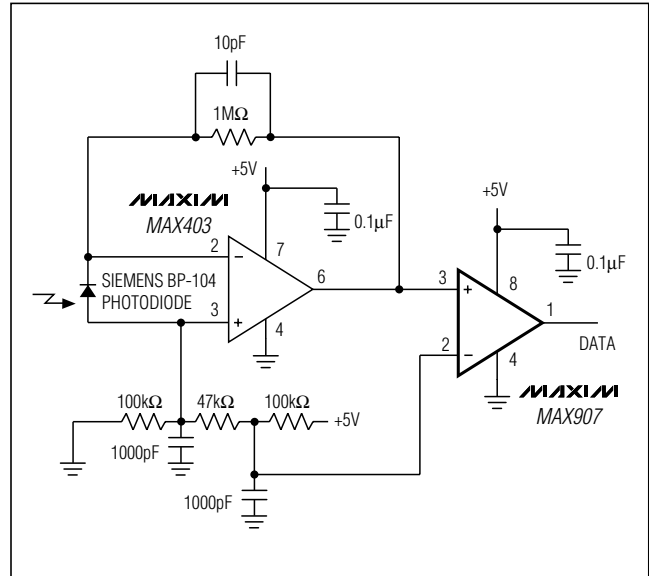
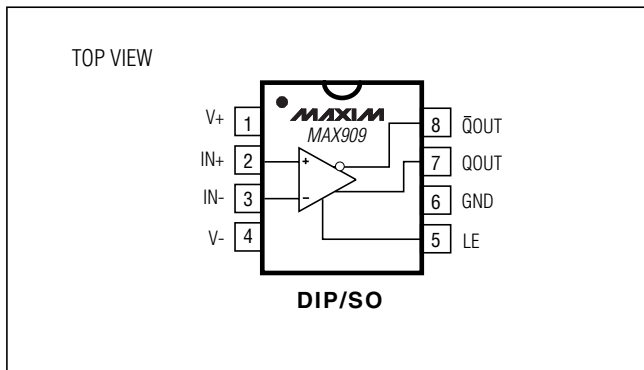

Figure 4. Battery-Operated Infrared Data Link Consumes Only 1mA

## Pin Configurations (continued)



## Ordering Information (continued)

| PART      | TEMP RANGE     | PIN-PACKAGE    |
|-----------|----------------|----------------|
| MAX908CPD | 0°C to +70°C   | 14 Plastic DIP |
| MAX908CSD | 0°C to +70°C   | 14 SO          |
| MAX908EPD | -40°C to +85°C | 14 Plastic DIP |
| MAX908ESD | -40°C to +85°C | 14 SO          |
| MAX909CPA | 0°C to +70°C   | 8 Plastic DIP  |
| MAX909CSA | 0°C to +70°C   | 8 SO           |
| MAX909EPA | -40°C to +85°C | 8 Plastic DIP  |
| MAX909ESA | -40°C to +85°C | 8 SO           |

## Chip Information

MAX907 TRANSISTOR COUNT: 262

MAX908 TRANSISTOR COUNT: 536

MAX909 TRANSISTOR COUNT: 140

PROCESS: Bipolar

Maxim cannot assume responsibility for use of any circuitry other than circuitry entirely embodied in a Maxim product. No circuit patent licenses are implied. Maxim reserves the right to change the circuitry and specifications without notice at any time.

10 Maxim Integrated Products, 120 San Gabriel Drive, Sunnyvale, CA 94086 408-737-7600