

General Description

The SC2200 evaluation kits (SC2200-EVK) provide the hardware and software graphical user interface (GUI) necessary for the evaluation of the SC2200. The SC2200 belongs to the 4th-generation family of RF PA linearizers (RFPAL) that provide increased integration and functionality over the previous generations. The SC2200 is a dual-path linearizer that is a fully-adaptive, RFIN/RFOUT predistortion linearization solution optimized for a wide range of amplifiers, power levels, and communication protocols. It supports 2G to 4G standards (FDD and TDD) from 698MHz to 2700MHz, as well as an expanded range of signal bandwidths from 60MHz down to 1.2MHz. The device accepts single-ended RF signals to eliminate baluns and features a mirrored pinout facilitating design of both paths. The SC2200 uses the PA output and input signals to adaptively generate an optimized correction function to minimize the PA's distortion. Using RF-domain analog signal processing enables the SC2200 to operate over wide bandwidths and with very low power consumption. The dual linearizer can be used for small cell MIMO, active antennas, distributed antennas, or in systems requiring two different simplex bands.

Applications

- Cellular Infrastructure
 - Single/Multicarrier, Multistandard: CDMA/EVDO, TD-SCDMA, WiMAX, WCDMA/HSDPA, LTE, and TD-LTE
 - BTS Amplifiers, RRH, Booster Amplifiers, Repeaters, Small Cells, Microcells, Picocells, DAS, AAS, and MIMO Systems
- Wide Range of PAs and Output Power
 - Amplifier: Class A/AB, Doherty
 - Average PA Output Power Examples:
 - Cellular Infrastructure: 27dBm to 40dBm
 - PA Process: LDMOS, GaN, HBT, GaAs, and InGaP

Benefits

- Ease of Use
 - Integrated RFIN/RFOUT Solution
- Reduces System Power Consumption and OPEX
- Reduces BOM Costs and Total Volume
 - Smaller Power Supply, Heat Sink, and Enclosure
 - Lower Back-Off Reduces Transistor Costs

Features

- Frequency Ranges:
 - SC2200-EVK900: 698–960MHz
 - SC2200-EVK1900: 1800–2200MHz
 - SC2200-EVK2400: 2300–2700MHz
- Integrated Preamp and Single-Ended RF I/Os
- Single +5V Supply Voltage
- Dual-Path RFIN/RFOUT Linearizer
- Fully Adaptive Correction
- Up to 28dB ACLR and 38dB IMD Improvement (1)
- $1.2\text{MHz} < \text{BWSIG} \leq 60\text{MHz}$

[Ordering Information](#) and [Block Diagram](#) appears at end of data sheet.

Typical Application Block Diagram

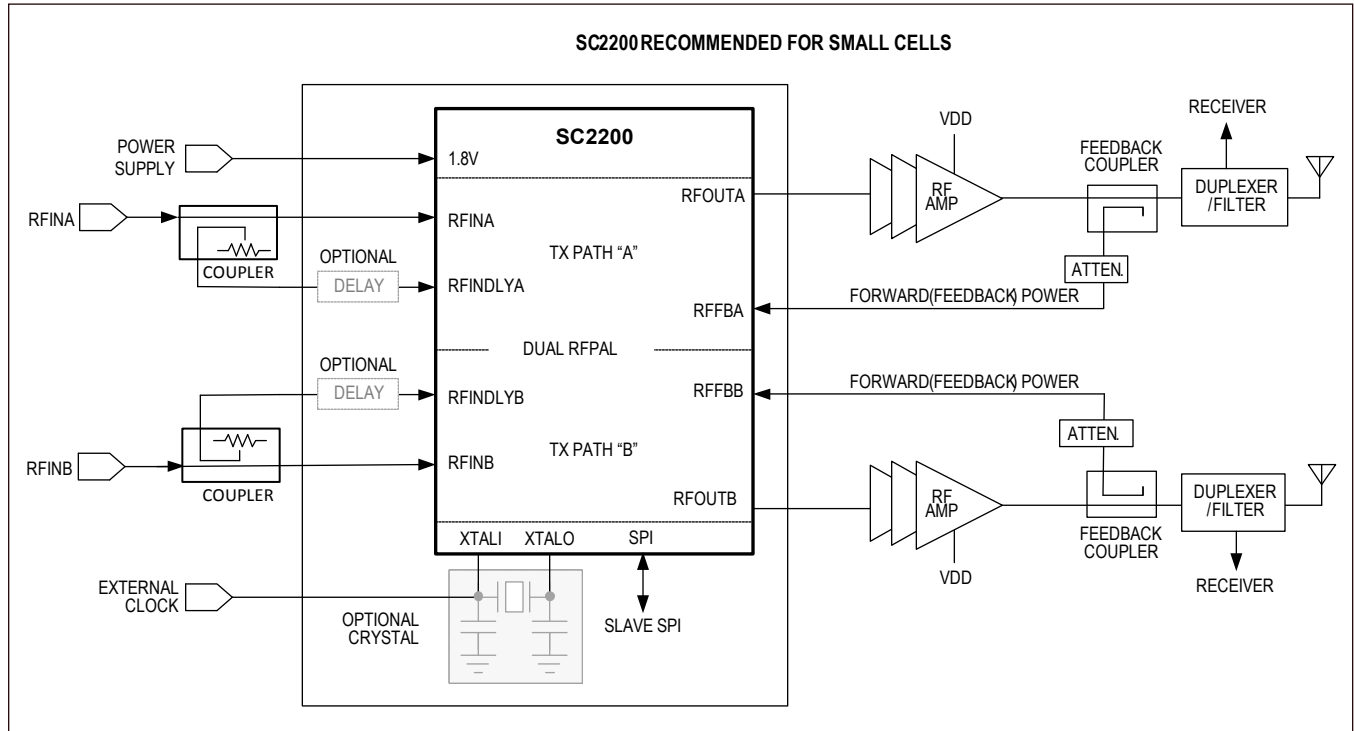

Evaluation Kit Ordering Information

PART NUMBER	DESCRIPTION
SC2200-EVK900	Evaluation kit, dual-RFPAL, 698MHz–960MHz
SC2200-EVK1900	Evaluation kit, dual-RFPAL, 1800MHz–2200MHz
SC2200-EVK2400	Evaluation kit, dual-RFPAL, 2300MHz–2700MHz

Component Information, PCB Layout, and Schematic

See the following links for component information, PCB layout diagram, and schematic.

- [SC2200 EV BOMs](#)
- [SC2200 EV PCB](#)
- [SC2200 EV Schematic](#)

Revision History

REVISION NUMBER	REVISION DATE	DESCRIPTION	PAGES CHANGED
0	11/15	Initial release	—

For pricing, delivery, and ordering information, please contact Maxim Direct at 1-888-629-4642, or visit Maxim Integrated's website at www.maximintegrated.com.

Maxim Integrated cannot assume responsibility for use of any circuitry other than circuitry entirely embodied in a Maxim Integrated product. No circuit patent licenses are implied. Maxim Integrated reserves the right to change the circuitry and specifications without notice at any time. The parametric values (min and max limits) shown in the Electrical Characteristics table are guaranteed. Other parametric values quoted in this data sheet are provided for guidance.

Bill of Materials						
Part Number:		SC2200-RDB900				
Revision:		1				
Date:		6/15/2015				
						
Designator	Comment	Description	Quantity	Manufacturer 1	Manufacturer Part Number 1	Supplier 1
C100, R121, R124, R161, R162, R167, R168, R194, R201, R252, R253, R255, R262	NL	NL Cap 0402, NL Res 0402, NL Res 0402, NO LOAD RESISTOR 0402, NO LOAD RESISTOR 0402, NO LOAD RESISTOR 0402, NO LOAD RESISTOR 0402, 0 Ohm 0402, 0 Ohm 0402, 0 Ohm 0402, 0 Ohm 0402, 0 Ohm 0402, 0 Ohm 0402, 0 Ohm 0402	13			
C101, C102, C130, C131	10pF	10pF 0402	4	Murata Electronics	GJM1555C1H100FB01D	Mouser
C106, C107, C120, C132	0.1uF	Cap 0.1uF 0402	4	TDK Corporation	C1005X7R1A104K050BB	Digi-Key
C108, C109, C111, C113, C114, C115, C116, C119, C126, C138, C140	1000pF	1000pF 0402	11	Murata Electronics	GRM1555C1H102JA01D	Mouser
C112, C118, C139, C141	2.2uF	2.2uF 0603	4	Murata Electronics	GRM188R71A225KE15J	Mouser
C122, C124	22uF	Cap 22uF 0805	2	Murata Electronics	GRM21BR60J226ME39L	Mouser
C125	5.0pF	5.0pF 0402	1	Murata Electronics	GJM1555C1H5R0BB01D	Mouser
C133, C151, C152	1uF	Cap 1uF 0402	3	Murata Electronics	GRM155R61A105KE15D	Mouser
C134	680pF	680pF 0402	1	Murata Electronics North America	GRM1555C1H681JA01D	Digi-Key
C135	10uF	Cap 10uF 0805	1	Murata Electronics North America	GRM21BR71A106KE51L	Digi-Key
C142	1uF	1uF 0603 ceramic capacitor	1	Murata Electronics North America	GRM188R61A105KA61D	Digi-Key
C143, C146, C154, C156	100pF	100pF 0402 Murata Capacitor	4	Murata	GRM1555C1H101JD01D	Farnell
C147, C148	5.1pF	5.1pF 0402	2	Murata Electronics	GJM1555C1H5R1BB01D	Mouser
C153, C155	1nF	1000pF 0402	2	Murata Electronics	GRM1555C1H102JA01D	Mouser
C160, C163, C292, C293	432	RESISTOR 432 Ohm 0402	4	Panasonic Electronic Components	ERJ-3EKF4320V	Digi-Key
C161, C162	0.5pF	0.5pF 0402	2	Murata Electronics North America	GJM1555C1HR50BB01D	Digi-Key
DC104, DC1015	5dB Coupler	Anaren 2300 - 2700 MHz 0805 5dB Coupler Conf-3, Anaren 2300 - 2700 MHz 0805 5dB Coupler Conf-4	2	Anaren	DC2327J5005AHF	Reil.com
FT100, FT101, FT102, FT103	Bead 120 ohm	Bead 0603 120 ohm	4	Murata Electronics	BLM18AG121SN1D	Mouser
FT104, FT105	Bead 470 ohm	Bead 0402 470 ohm	2	Murata Electronics	BLM15BD471SN1D	Mouser
J107	Banana Jack Red	Banana Supply Connector Red	1	Deltron	571-0900	Mouser
J108	Banana Jack Black	Banana Supply Connector Black	1	Deltron	571-0100	Mouser
J112	HEADER 12	Header 50mil SMT	1	HARTING	15110122601000	Mouser
L104, L105	18nH	18nH	2	Tayo Yuden	HK100518NJ-T	Digi-Key
R110	NL	NL Res 0603	1			
R111	10	RESISTOR 10 Ohm 0402	1	Panasonic Electronic Components	ERJ-2GEJ100X	Digi-Key
R112	237k	RESISTOR 237 kOhm 0402	1	Panasonic Electronic Components	ERJ-2RKF2373X	Digi-Key
R114	118k	RESISTOR 118 kOhm 0402	1	Panasonic Electronic Components	ERJ-2RKF1183X	Digi-Key
R118	10k	10k Ohm 0402	1	Yageo	RC0402FR-0710KL	Digi-Key
R165, R166, R195, R222, R223, R241, R250, R251, R254, R263, R300, R301	0 Ohm	0 Ohm 0402, 0 Ohm 0402, NO LOAD RESISTOR 0402, 0 Ohm 0402, 0 Ohm 0402, 0 Ohm 0402, 0 Ohm 0402, 0 Ohm 0402, 0 Ohm 0402, 0 Ohm 0402, 0 Ohm 0402	12	Yageo	RC0402JR-070RL	Digi-Key
R172, R265	49.9 Ohm	49.9 Ohm 0402	2	KOA Speer	RK73H1ELTP49R9F	Mouser
R192, R193	11.5 Ohm	0 Ohm 0402	2	Panasonic Electronic Components	ERJ-2RKF11R5X	Digi-Key
RFXLX_A, RFXLX_B, RFFB_A, RFFB_B, RFIN_A, RFIN_B, RFOUT_A, RFOUT_B	SMA_EDGE	SMA RECEPTACLE END LAUNCH, Emerson 142-0701-801	8	Cinch Connectivity Solutions Johnson	142-0701-801	Digi-Key
S100	SW-PB	SW, PUSH, Omronm B3S-1000P	1	Omron Electronics Inc-EMC Div	B3S-1000	Digi-Key
U100	SC2200	SC2200B	1	Maxim Integrated Products	SC2220-25	Engineering to provide
U102	EP53F8QJ	Enpirion Voltage Regulator	1	ENPIRION	EP53F8QJ	Newark
U103, U104	3ns Delay	3ns Delay Line (Anaren)	2	Anaren	XDL15-3-030S	Reil.com
XTAL1	NL	SMA RECEPTACLE END LAUNCH, Emerson 142-0701-801	1	Johnson-Cinch Connectivity Solutions	142-0701-201	Allied
Y100	278-20.0M-20-W	Crystal 20MHz 278-20.0M-20-W	1	Oscilont	278-20.0M-20-W	Oscilont
			108			
Notes:						
Please use this BoM to build 10 boards and label the board SC2200-RDB900 and serialize the board 1 to 10 in the white box.						
(NL) are no load parts.						

Bill of Materials

Part Number:	SC2200-RDB1900
Revision:	1
Date:	6/15/2015



Designator	Comment	Description	Quantity	Manufacturer 1	Manufacturer Part Number 1	Supplier 1
C100, C160, C163, R121, R124, R161, R162, R167, R168, R194, R201, R252, R253, R255, R262	NL	NL Cap 0402, 1.2pF 0402, 1.2pF 0402, NL Res 0402, NL Res 0402, NO LOAD RESISTOR 0402, NO LOAD RESISTOR 0402, NO LOAD RESISTOR 0402, NO LOAD RESISTOR 0402, 0 Ohm 0402, 0 Ohm 0402, 0 Ohm 0402, 0 Ohm 0402, 0 Ohm 0402	15	[NoParam], Murata Electronics, Murata Electronics, [NoParam], [NoParam], [NoParam], [NoParam], Yageo, Yageo, Yageo, Yageo	[NoParam], GJM1555C1H1R2B801D, GJM1555C1H1R2B801D, [NoParam], [NoParam], [NoParam], [NoParam], RC0402JR-070RL, RC0402JR-070RL, RC0402JR-070RL, RC0402JR-070RL, RC0402JR-070RL	[NoParam], Mouser, Mouser, [NoParam], [NoParam], [NoParam], [NoParam], Digi-Key, Digi-Key, Digi-Key, Digi-Key, Digi-Key, Digi-Key
C101, C102, C130, C131	10pF	10pF 0402	4	Murata Electronics	GJM1555C1H100FB01D	Mouser
C106, C107, C120, C132	0.1uF	Cap 0.1uF 0402	4	TDK Corporation	C1005X7R1A104K050BB	Digi-Key
C108, C109, C111, C113, C114, C115, C116, C119, C126, C138, C140	1000pF	1000pF 0402	11	Murata Electronics	GRM1555C1H102JA01D	Mouser
C112, C118, C139, C141	2.2uF	2.2uF 0603	4	Murata Electronics	GRM188R71A225KE15J	Mouser
C122, C124	22uF	Cap 22uF 0805	2	Murata Electronics	GRM21BR60J226ME39L	Mouser
C125	5.0pF	5.0pF 0402	1	Murata Electronics	GJM1555C1H5R0B801D	Mouser
C133, C151, C152	1uF	Cap 1uF 0402	3	Murata Electronics	GRM155R61A105KE15D	Mouser
C134	680pF	680pF 0402	1	Murata Electronics North America	GRM1555C1H681JA01D	Digi-Key
C135	10uF	Cap 10uF 0805	1	Murata Electronics North America	GRM21BR71A106KE51L	Digi-Key
C142	1uF	1uF 0603 ceramic capacitor	1	Murata Electronics North America	GRM188R61A105KA61D	Digi-Key
C143, C146, R300, R301	2.2pF	2.2pF 0402	4	Murata Electronics	GJM1555C1H2R2B801D	Mouser
C147, C148	5.6nH	5.6nH	2	Taiyo Yuden	HK1005SN6S-T	Digi-Key
C153, C155	1nF	1000pF 0402	2	Murata Electronics	GRM1555C1H102JA01D	Mouser
C154, C156	100pF	100pF 0402 Murata Capacitor	2	Murata	GRM1555C1H101JD01D	Farnell
C161, C162	0.5pF	0.5pF 0402	2	Murata Electronics North America	GJM1555C1HR50B801D	Digi-Key
C292, C293	1.3pF	1.3pF 0402	2	Murata Electronics	GJM1555C1H1R3B801D	Mouser
DC104, DC1015	5dB Coupler	Anaren 2300 - 2700 MHz 0805 5dB Coupler Conf-3, Anaren 2300 - 2700 MHz 0805 5dB Coupler Conf-4	2	Anaren	DC2327J5005AHF	Reil.com
FT100, FT101, FT102, FT103	Bead 120 ohm	Bead 0603 120 ohm	4	Murata Electronics	BLM18AG121SN1D	Mouser
FT104, FT105	Bead 470 ohm	Bead 0402 470 ohm	2	Murata Electronics	BLM158D471SN1D	Mouser
J107	Banana Jack Red	Banana Supply Connector Red	1	Deltron	571-0500	Mouser
J108	Banana Jack Black	Banana Supply Connector Black	1	Deltron	571-0100	Mouser
J112	HEADER 12	Header 50mil SMT	1	HARTING	15110122601000	Mouser
L104, L105	10nH	10nH	2	Taiyo Yuden	HK100510NJ-T	Digi-Key
R110	NL	NL Res 0603	1			
R111	10	RESISTOR 10 Ohm 0402	1	Panasonic Electronic Components	ERJ-2GEJ100X	Digi-Key
R112	237k	RESISTOR 237 kOhm 0402	1	Panasonic Electronic Components	ERJ-2RKF2373X	Digi-Key
R114	118k	RESISTOR 118 kOhm 0402	1	Panasonic Electronic Components	ERJ-2RKF1183X	Digi-Key
R118	10k	10k Ohm 0402	1	Yageo	RC0402FR-0710KL	Digi-Key
R165, R166, R195, R222, R223, R241, R250, R251, R254, R263	0 Ohm	0 Ohm 0402, 0 Ohm 0402, NO LOAD RESISTOR 0402, 0 Ohm 0402, 0 Ohm 0402, 0 Ohm 0402, 0 Ohm 0402, 0 Ohm 0402, 0 Ohm 0402	10	Yageo	RC0402JR-070RL	Digi-Key
R172, R265	49.9 Ohm	49.9 Ohm 0402	2	KOA Speer	RK73H1ELTP49R9F	Mouser
R192, R193	1.0nH	1.0nH	2	Taiyo Yuden	HK10051N0S-T	Digi-Key
RFAUX_A, RFAUX_B, RFFB_A, RFFB_B, RFIN_A, RFIN_B, RFOUT_A, RFOUT_B	SMA_EDGE	SMA RECEPTACLE END LAUNCH, Emerson 142-0701-801	8	Cinch Connectivity Solutions Johnson	142-0701-801	Digi-Key
S100	SW-PB	SW, PUSH, Omronm B3S-1000P	1	Omron Electronics Inc-EMC Div	B3S-1000	Digi-Key
U100	SC2200	SC2200B	1	Maxim Integrated Products	SC2220-25	Engineering to provide
U102	EP53F8Q1	Enpirion Voltage Regulator	1	Loading...	Loading...	Newark
U103, U104	3ns Delay	3ns Delay Line (Anaren)	2	Anaren	XD15-3-030S	Reil.com
XTALI	NL	SMA RECEPTACLE END LAUNCH, Emerson 142-0701-801	1	Johnson-Cinch Connectivity Solutions	142-0701-201	Allied
Y100	278-20.0M-20-W	Crystal 20MHz 278-20.0M-20-W	1	Oscilent	278-20.0M-20-W	Oscilent

Notes:
Please use this BoM to build 10 boards and label the board SC2200-RDB1900 and serialize the board 11 to 20 in the white box. (NL) are no load parts.

108

Bill of Materials

Part Number:	SC2200_RDB2400
Revision:	1
Date:	6/15/2015



Designator	Comment	Description	Quantity	Manufacturer 1	Manufacturer Part Number 1	Supplier 1
C100, C292, C293, R121, R124, R161, R162, R167, R168, R194, R201, R252, R253, R255, R262	NL	NL Cap 0402, 1.3pF 0402, 1.3pF 0402, NL Res 0402, NL Res 0402, NO LOAD RESISTOR 0402, NO LOAD RESISTOR 0402, NO LOAD RESISTOR 0402, NO LOAD RESISTOR 0402, 0 Ohm 0402, 0 Ohm 0402, 0 Ohm 0402, 0 Ohm 0402, 0 Ohm 0402	15	[NoParam], Murata Electronics, Murata Electronics, [NoParam], [NoParam], [NoParam], Yageo, Yageo, Yageo, Yageo	[NoParam], GJM1555C1H1R3B801D, GJM1555C1H1R3B801D, [NoParam], [NoParam], [NoParam], [NoParam], RC0402JR-070RL, RC0402JR-070RL, RC0402JR-070RL, RC0402JR-070RL, RC0402JR-070RL	[NoParam], Mouser, Mouser, [NoParam], [NoParam], [NoParam], [NoParam], Digi-Key, Digi-Key, Digi-Key, Digi-Key
C101, C102, C130, C131	10pF	10pF 0402	4	Murata Electronics	GJM1555C1H100FB01D	Mouser
C106, C107, C120, C132	0.1uF	Cap 0.1uF 0402	4	TDK Corporation	C1005X7R1A104K050BB	Digi-Key
C108, C109, C111, C113, C114, C115, C116, C119, C126, C138, C140	1000pF	1000pF 0402	11	Murata Electronics	GRM1555C1H102JA01D	Mouser
C112, C118, C139, C141	2.2uF	2.2uF 0603	4	Murata Electronics	GRM188R71A225KE15J	Mouser
C122, C124	22uF	Cap 22uF 0805	2	Murata Electronics	GRM21BR60J226ME39L	Mouser
C125	5.0pF	5.0pF 0402	1	Murata Electronics	GJM1555C1H5R0B801D	Mouser
C133, C151, C152	1uF	Cap 1uF 0402	3	Murata Electronics	GRM155R61A105KE15D	Mouser
C134	680pF	680pF 0402	1	Murata Electronics North America	GRM1555C1H681JA01D	Digi-Key
C135	10uF	Cap 10uF 0805	1	Murata Electronics North America	GRM21BR71A106KE51L	Digi-Key
C142	1uF	1uF 0603 ceramic capacitor	1	Murata Electronics North America	GRM188R61A105KA61D	Digi-Key
C143, C146, C154, C156	100pF	100pF 0402 Murata Capacitor	4	Murata	GRM1555C1H101JD01D	Farnell
C147, C148	5.6nH	5.6nH	2	Taiyo Yuden	HK10055N6S-T	Digi-Key
C153, C155	1nF	1000pF 0402	2	Murata Electronics	GRM1555C1H102JA01D	Mouser
C160, C163, R300, R301	1.2pF	1.2pF 0402	4	Murata Electronics	GJM1555C1H1R2E801D	Mouser
C161, C162	0.5pF	0.5pF 0402	2	Murata Electronics North America	GJM1555C1HR50B801D	Digi-Key
DC104, DC1015	5dB Coupler	Anaren 2300 - 2700 MHz 0805 5dB Coupler Conf-3, Anaren 2300 - 2700 MHz 0805 5dB Coupler Conf-4	2	Anaren	DC2327J5005AHF	Reel.com
FT100, FT101, FT102, FT103	Bead 120 ohm	Bead 0603 120 ohm	4	Murata Electronics	BLM18AG121SN1D	Mouser
FT104, FT105	Bead 470 ohm	Bead 0402 470 ohm	2	Murata Electronics	BLM15BD471SN1D	Mouser
J107	Banana Jack Red	Banana Supply Connector Red	1	Deltron	571-0500	Mouser
J108	Banana Jack Black	Banana Supply Connector Black	1	Deltron	571-0100	Mouser
J112	HEADER 12	Header 50mil SMT	1	HARTING	15110122601000	Mouser
L104, L105	10nH	10nH	2	Taiyo Yuden	HK100510NJ-T	Digi-Key
R110	NL	NL Res 0603	1			
R111	10	RESISTOR 10 Ohm 0402	1	Panasonic Electronic Components	ERJ-2GEJ100X	Digi-Key
R112	237k	RESISTOR 237 kOhm 0402	1	Panasonic Electronic Components	ERJ-2RKF2373X	Digi-Key
R114	118k	RESISTOR 118 kOhm 0402	1	Panasonic Electronic Components	ERJ-2RKF1183X	Digi-Key
R118	10k	10k Ohm 0402	1	Yageo	RC0402FR-0710KL	Digi-Key
R165, R166, R192, R193, R195, R222, R223, R241, R250, R251, R254, R263	0 Ohm	0 Ohm 0402, 0 Ohm 0402, 0 Ohm 0402, NO LOAD RESISTOR 0402, 0 Ohm 0402, 0 Ohm 0402, 0 Ohm 0402, 0 Ohm 0402, 0 Ohm 0402, 0 Ohm 0402	12	Yageo	RC0402JR-070RL	Digi-Key
R172, R265	49.9 Ohm	49.9 Ohm 0402	2	KOA Speer	RK73H1ELTP49R9F	Mouser
RFAUX_A, RFAUX_B, RFFB_A, RFFB_B, RFIN_A, RFIN_B, RFOUT_A, RFOUT_B	SMA_EDGE	SMA RECEPTACLE END LAUNCH, Emerson 142-0701-801	8	Cinch Connectivity Solutions Johnson	142-0701-801	Digi-Key
S100	SW-PB	SW, PUSH, Omronm B3S-1000P	1	Omron Electronics Inc-EMC Div	B3S-1000	Digi-Key
U100	SC2200	SC2200B	1	Maxim Integrated Products	SC2200-25	Engineering to provide
U102	EP53F8QJ	Enenion Voltage Regulator	1	ENPIRION	EP53F8QJ	Newark
U103, U104	3ns Delay	3ns Delay Line (Anaren)	2	Anaren	XDL15-3-030S	Reel.com
XTALI	NL	SMA RECEPTACLE END LAUNCH, Emerson 142-0701-801	1	Johnson-Cinch Connectivity Solutions	142-0701-201	Allied
Y100	278-20.0M-20-W	Crystal 20MHz 278-20.0M-20-W	1	Oscilent	278-20.0M-20-W	Oscilent

Notes:
 Please use this BoM to build 10 boards and label the board SC2200-RDB2400 and serialize the board 21 to 30 in the white box. (NL) are no load parts.

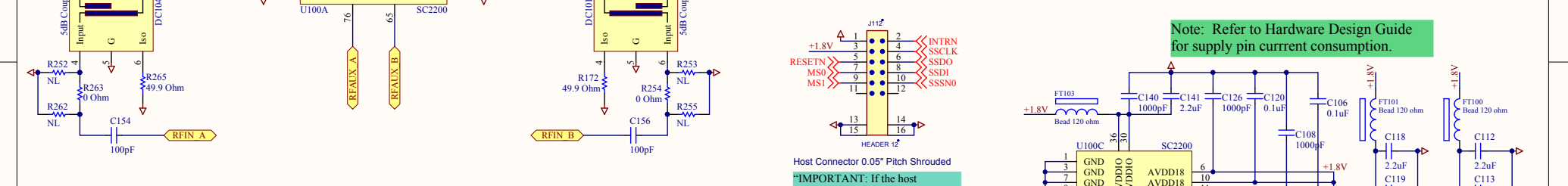
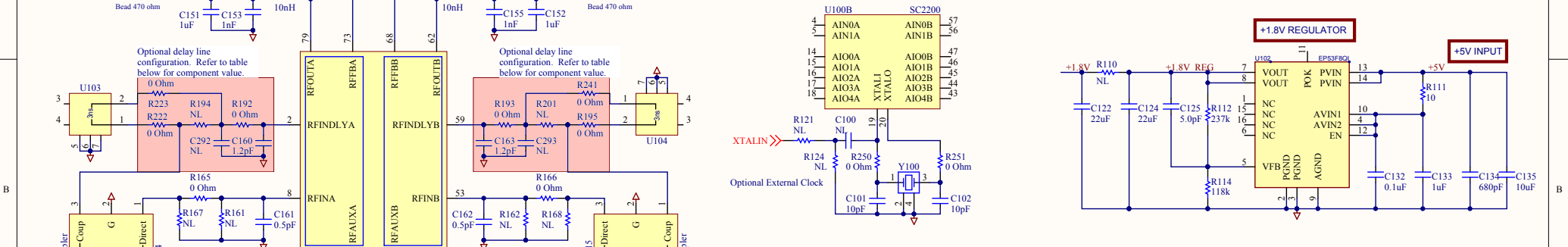
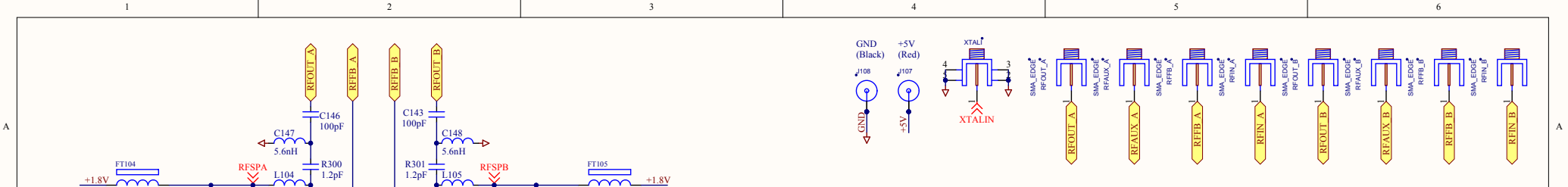

Component Reference	Delay Line Configuration Options					
	EVK900 (700-960 MHz)		EVK1900 (1800-2200 MHz)		EVK2400 (2300-2800 MHz)	
	No delay line (classAB)	With delay line (doherty or wide IBW)	No delay line (classAB)	With delay line (doherty or wide IBW)	No delay line (classAB)	With delay line (doherty or wide IBW)
Designator	Value	Value	Value	Value	Value	Value
R194	0 Ohm	NL	0 Ohm	NL	0 Ohm	NL
R222	NL	0 Ohm	NL	0 Ohm	NL	0 Ohm
R223	NL	0 Ohm	NL	0 Ohm	NL	0 Ohm
C292	221 Ohm	432 Ohm	221 Ohm	1.3pF	221 Ohm	NL
R192	24.3 Ohm	11.5 Ohm	24.3 Ohm	1nH	24.3 Ohm	0 Ohm
C160	221 Ohm	432 Ohm	221 Ohm	NL	221 Ohm	1.2pF
R201	0 Ohm	NL	0 Ohm	NL	0 Ohm	NL
R195	NL	0 Ohm	NL	0 Ohm	NL	0 Ohm
R241	NL	0 Ohm	NL	0 Ohm	NL	0 Ohm
C293	221 Ohm	423 Ohm	221 Ohm	1.3pF	221 Ohm	NL
R193	24.3 Ohm	11.5 Ohm	24.3 Ohm	1nH	24.3 Ohm	0 Ohm
C163	221 Ohm	432 Ohm	221 Ohm	NL	221 Ohm	1.2pF

Default Configuration in **BOLD**. Refer to Hardware Design Guide for detail.

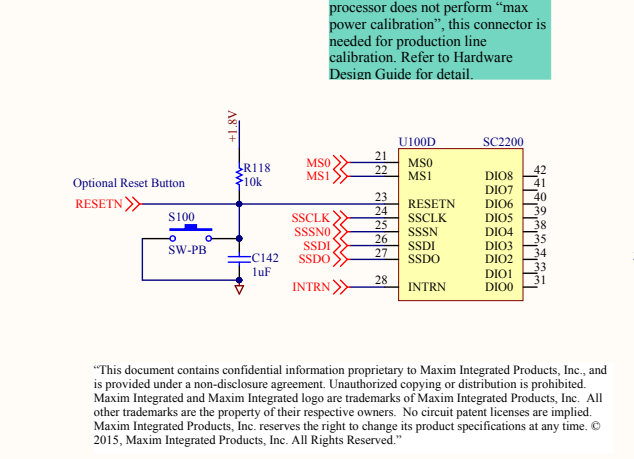

"This document contains confidential information proprietary to Maxim Integrated Products, Inc., and is provided under a non-disclosure agreement. Unauthorized copying or distribution is prohibited. Maxim Integrated and Maxim Integrated logo are trademarks of Maxim Integrated Products, Inc. All other trademarks are the property of their respective owners. No circuit patent licenses are implied. Maxim Integrated Products, Inc. reserves the right to change its product specifications at any time. © 2015, Maxim Integrated Products, Inc. All Rights Reserved."

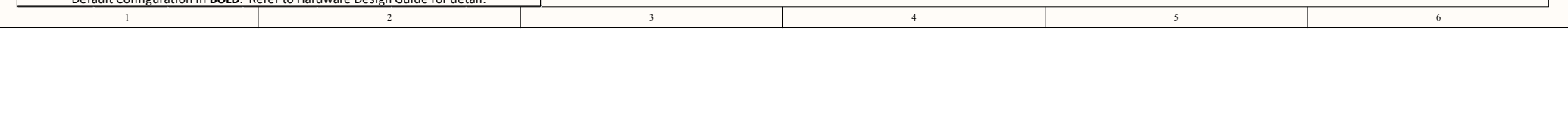

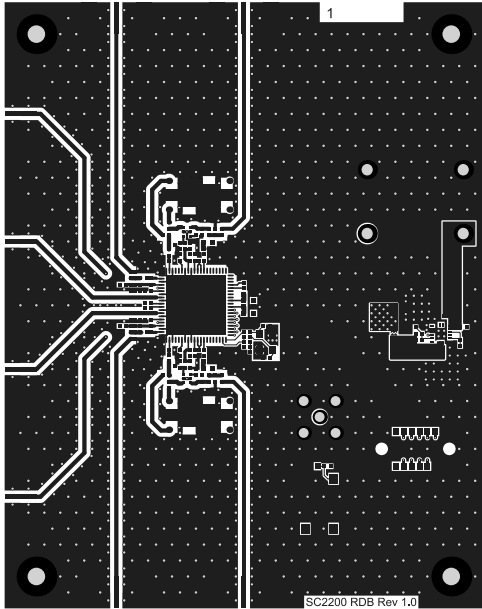

Maxim Integrated
Top Layer 1

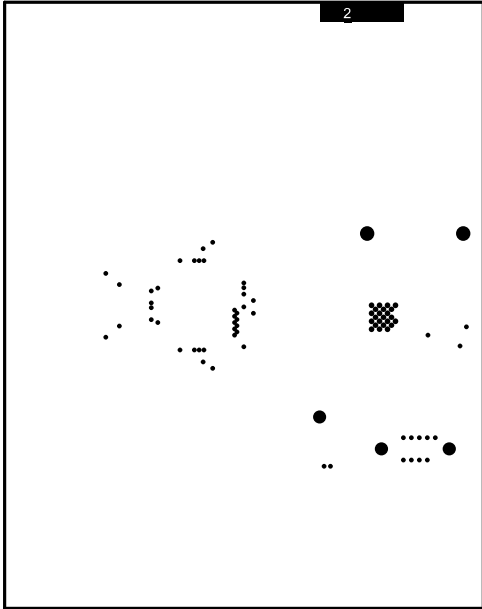

Maxim Integrated
GND Layer 2

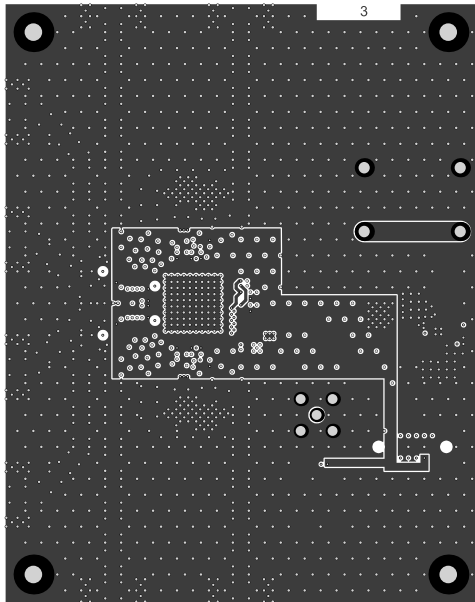

Maxim Integrated
Internal Layer 3

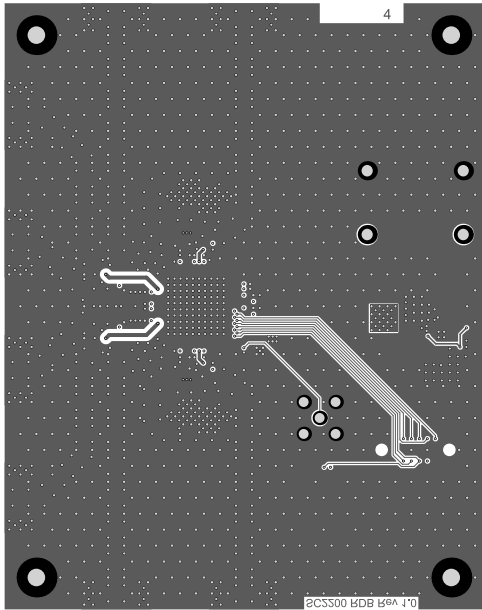

Maxim Integrated
Bottom Layer 4

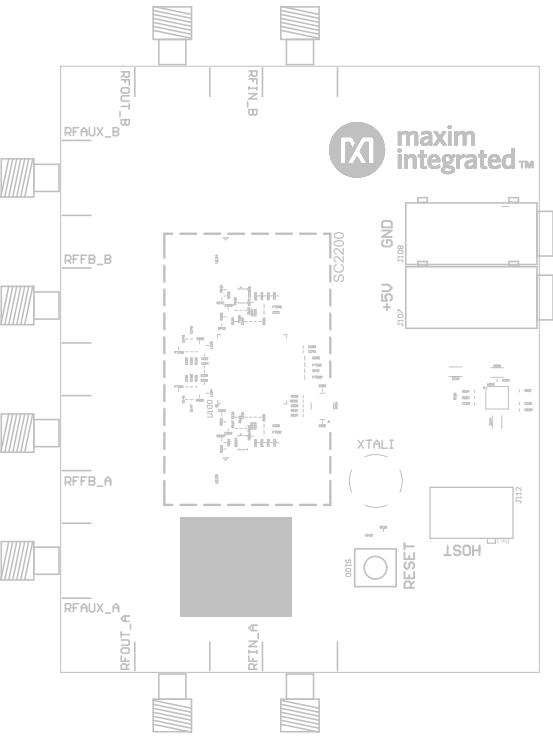

Maxim Integrated
Top Overlay

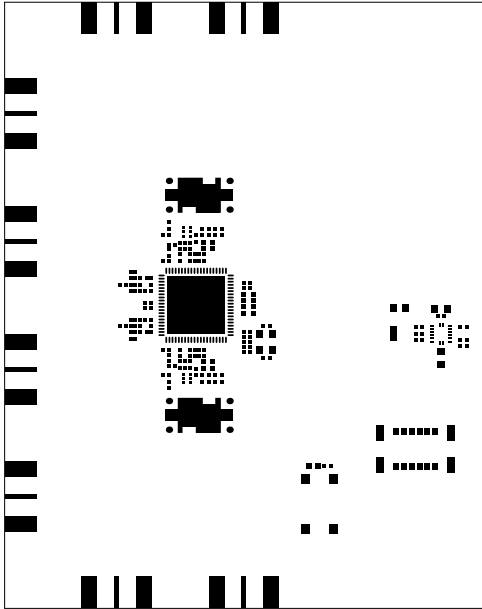

Maxim Integrated
Top Paste

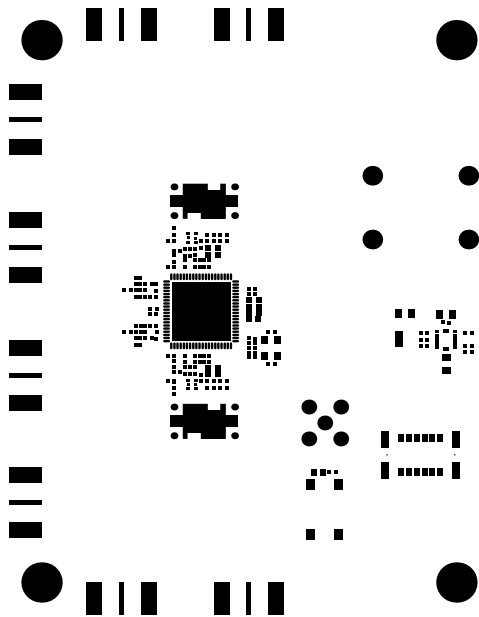

Maxim Integrated
Top Solder Mask

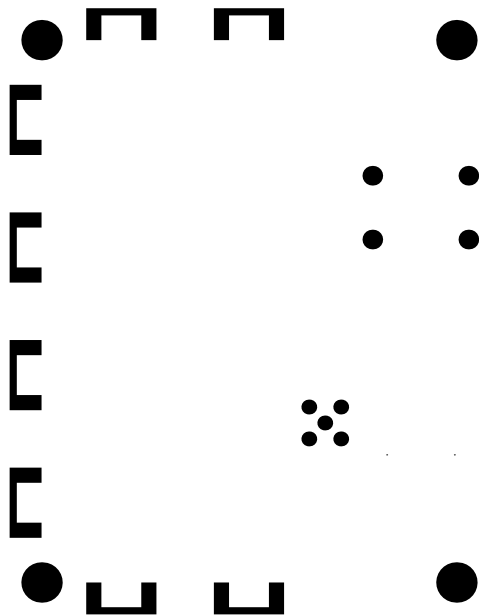

Maxim Integrated
Bottom Solder Mask

Symbol	Hit Count	Finished Hole Size	Plated	Hole Type
⊗	2	62.99mil (1.600mm)	NPTH	Round
◇	4	71.00mil (1.803mm)	PTH	Round
■	4	110.00mil (2.794mm)	PTH	Round
⊙	5	62.00mil (1.575mm)	PTH	Round
□	58	10.00mil (0.254mm)	PTH	Round
○	1457	15.00mil (0.381mm)	PTH	Round
	1530 Total			

