

# 14V<sub>P-P</sub>, Class G Ceramic Speaker Driver

## General Description

The MAX9788 features a mono Class G power amplifier with an integrated inverting charge-pump power supply specifically designed to drive the high capacitance of a ceramic loudspeaker. The charge pump can supply greater than 700mA of peak output current at 5.5VDC, guaranteeing an output of 14V<sub>P-P</sub>.

The MAX9788 maximizes battery life by offering high-performance efficiency. Maxim's proprietary Class G output stage provides efficiency levels greater than Class AB devices without the EMI penalties commonly associated with Class D amplifiers.

The MAX9788 is ideally suited to deliver the high output-voltage swing required to drive ceramic/piezoelectric speakers.

The device utilizes fully differential inputs and outputs, comprehensive click-and-pop suppression, shutdown control, and soft-start circuitry. The MAX9788 is fully specified over the -40°C to +85°C extended temperature range and is available in small lead-free 28-pin TQFN (4mm x 4mm) or 20-bump WLP (2mm x 2.5mm) packages.

## Applications

Cell Phones  
Smartphones  
MP3 Players

Personal Media Players  
Handheld Gaming  
Consoles  
Notebook Computers

## Features

- ◆ Integrated Charge-Pump Power Supply—No Inductor Required
- ◆ 14V<sub>P-P</sub> Voltage Swing into Piezoelectric Speaker
- ◆ 2.7V to 5.5V Single-Supply Operation
- ◆ Clickless/Popless Operation
- ◆ Small Thermally Efficient Packages
  - 4mm x 4mm 28-Pin TQFN
  - 2mm x 2.5mm 20-Bump WLP

## Ordering Information

PART	PIN-PACKAGE	TEMP RANGE
MAX9788EWP+TG45	20 WLP	-40°C to +85°C
MAX9788ETI+	28 TQFN-EP*	-40°C to +85°C

+ Denotes a lead-free package.

T = Tape and reel.

G45 indicates protective die coating.

\*EP = Exposed pad.

Typical Application Circuit/Functional Diagram and Pin Configurations appear at end of data sheet.

## Simplified Block Diagram

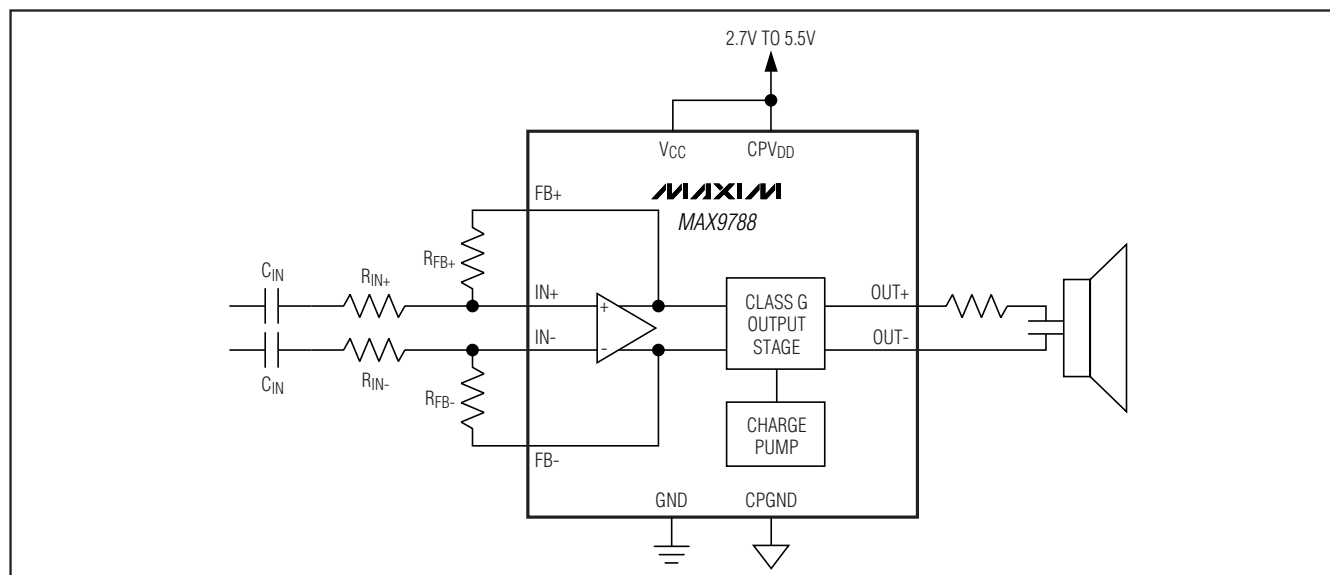

# 14VP-P, Class G Ceramic Speaker Driver

## ABSOLUTE MAXIMUM RATINGS

(Voltages with respect to GND.)

V <sub>CC</sub> , CPV <sub>DD</sub> .....	-0.3V to +6V
PV <sub>SS</sub> , SV <sub>SS</sub> .....	-6V to +0.3V
CPGND .....	-0.3V to +0.3V
OUT+, OUT- .....	(SV <sub>SS</sub> - 0.3V) to (V <sub>CC</sub> + 0.3V)
IN+, IN-, FB+, FB- .....	-0.3V to (V <sub>CC</sub> + 0.3V)
C1N .....	(PV <sub>SS</sub> - 0.3V) to (CPGND + 0.3V)
C1P .....	(CPGND - 0.3V) to (CPV <sub>DD</sub> + 0.3V)
FS, SHDN .....	-0.3V to (V <sub>CC</sub> + 0.3V)
Continuous Current Into/Out of OUT+, OUT-, V <sub>CC</sub> , GND, SV <sub>SS</sub> .....	800mA

CPV <sub>DD</sub> , CPGND, C1P, C1N, PV <sub>SS</sub> .....	800mA
Any Other Pin .....	20mA
Continuous Power Dissipation (T <sub>A</sub> = +70°C)	
20-Bump WLP (derate 10.3mW/°C above +70°C) (Note 1) .....	827mW
28-Pin TQFN (derate 20.8mW/°C above +70°C) .....	1667mW
Operating Temperature Range .....	-40°C to +85°C
Storage Temperature Range .....	-65°C to +150°C
Lead Temperature (soldering, 10s) .....	+300°C
Bump Temperature (soldering) Reflow .....	+235°C

**Note 1:** Package thermal resistances were obtained using the method described in JEDEC specification JESD51-7, using a four-layer board. For detailed information on package thermal considerations, see [www.maxim-ic.com/thermal-tutorial](http://www.maxim-ic.com/thermal-tutorial).

Stresses beyond those listed under "Absolute Maximum Ratings" may cause permanent damage to the device. These are stress ratings only, and functional operation of the device at these or any other conditions beyond those indicated in the operational sections of the specifications is not implied. Exposure to absolute maximum rating conditions for extended periods may affect device reliability.

## ELECTRICAL CHARACTERISTICS

(V<sub>CC</sub> = V<sub>CPVDD</sub> = V<sub>SHDN</sub> = 3.6V, V<sub>GND</sub> = V<sub>CPGND</sub> = 0V, R<sub>IN+</sub> = R<sub>IN-</sub> = 10kΩ, R<sub>FB+</sub> = R<sub>FB-</sub> = 10kΩ, R<sub>FS</sub> = 100kΩ, C1 = 4.7μF, C2 = 10μF; load connected between OUT+ and OUT-, Z<sub>LOAD</sub> = 10Ω + 1μF, unless otherwise stated; T<sub>A</sub> = T<sub>MIN</sub> to T<sub>MAX</sub>, unless otherwise noted. Typical values are at T<sub>A</sub> = +25°C.) (Notes 2, 3)

PARAMETER	SYMBOL	CONDITIONS	MIN	TYP	MAX	UNITS
<b>GENERAL</b>						
Supply Voltage Range	V <sub>CC</sub>	Inferred from PSRR test	2.7		5.5	V
Quiescent Current	I <sub>CC</sub>			8	12	mA
Shutdown Current	I <sub>SHDN</sub>	SHDN = GND		0.3	5	μA
Turn-On Time	t <sub>ON</sub>	Time from shutdown or power-on to full operation		50		ms
Input DC Bias Voltage	V <sub>BIAS</sub>	IN_ inputs (Note 4)	1.1	1.24	1.4	V
Charge-Pump Oscillator Frequency	f <sub>OSC</sub>	I <sub>LOAD</sub> = 0mA (slow mode)	55	83	110	kHz
		I <sub>LOAD</sub> > 100mA (normal mode)	230	330	470	
SHDN Input Threshold (Note 5)		V <sub>IH</sub>	1.4			V
		V <sub>IL</sub>			0.4	
SHDN Input Leakage Current					±1	μA
<b>SPEAKER AMPLIFIER</b>						
Output Offset Voltage	V <sub>OS</sub>	T <sub>A</sub> = +25°C		±3	±15	mV
		T <sub>MIN</sub> ≤ T <sub>A</sub> ≤ T <sub>MAX</sub>			±20	
Click-and-Pop Level	V <sub>CP</sub>	Peak voltage into/out of shutdown A-weighted, 32 samples per second (Notes 6, 7)		-67		dBV
Voltage Gain	A <sub>V</sub>	(Notes 4, 8)	11.5	12	12.5	dB
Output Voltage	V <sub>OUT</sub>	f = 1kHz, 1% THD+N	V <sub>CC</sub> = 5V		7.1	V <sub>RMS</sub>
			V <sub>CC</sub> = 4.2V		5.9	
			V <sub>CC</sub> = 3.6V		5.1	
			V <sub>CC</sub> = 3.0V		4.2	

# 14VP-P, Class G Ceramic Speaker Driver

MAX9788

## ELECTRICAL CHARACTERISTICS (continued)

( $V_{CC} = V_{CPVDD} = V_{SHDN} = 3.6V$ ,  $V_{GND} = V_{CPGND} = 0V$ ,  $R_{IN+} = R_{IN-} = 10k\Omega$ ,  $R_{FB+} = R_{FB-} = 10k\Omega$ ,  $R_{FS} = 100k\Omega$ ,  $C1 = 4.7\mu F$ ,  $C2 = 10\mu F$ ; load connected between  $OUT+$  and  $OUT-$ ;  $Z_{LOAD} = 10\Omega + 1\mu F$ , unless otherwise stated;  $T_A = T_{MIN}$  to  $T_{MAX}$ , unless otherwise noted. Typical values are at  $T_A = +25^\circ C$ .) (Notes 2, 3)

PARAMETER	SYMBOL	CONDITIONS	MIN	TYP	MAX	UNITS
Output Voltage	$V_{OUT}$	$f = 10kHz$ , 1% THD+N, $Z_L = 1\mu F + 10\Omega$ , no load	$V_{CC} = 5V$	6.5		$V_{RMS}$
			$V_{CC} = 4.2V$	5.4		
			$V_{CC} = 3.6V$	4.7		
			$V_{CC} = 3.0V$	3.3		
Continuous Output Power	$P_{OUT}$	1% THD+N, $f = 1kHz$ , $R_L = 8\Omega$	$V_{CC} = 5V$	2.4		W
			$V_{CC} = 4.2V$	1.67		
			$V_{CC} = 3.6V$	1.25		
			$V_{CC} = 3.0V$	0.8		
Power-Supply Rejection Ratio (Note 4)	PSRR	$V_{CC} = 2.7V$ to $5.5V$	63	77	dB	
		$f = 217Hz$ , 200mV <sub>p-p</sub> ripple		77		
		$f = 1kHz$ , 200mV <sub>p-p</sub> ripple		77		
		$f = 20kHz$ , 200mV <sub>p-p</sub> ripple		58		
Total Harmonic Distortion Plus Noise	THD+N	$Z_L = 1\mu F + 10\Omega$ , $V_{OUT} = 1kHz / 1.9V_{RMS}$		0.002	%	
		$Z_L = 1\mu F + 10\Omega$ , $V_{OUT} = 1kHz / 4.0V_{RMS}$		0.08		
Signal-to-Noise Ratio	SNR	$V_{OUT} = 5.1V_{RMS}$ , A-weighted		108	dB	
Common-Mode Rejection Ratio	CMRR	$f_{IN} = 1kHz$ (Note 9)		68	dB	
Dynamic Range	DR	A-weighted (Note 10)	$V_{CC} = 5V$	106		dB
			$V_{CC} = 3.6V$	105		

**Note 2:** All devices are 100% production tested at room temperature. All temperature limits are guaranteed by design.

**Note 3:** Testing performed with resistive and capacitive loads to simulate an actual ceramic/piezoelectric speaker load,  $Z_L = 1\mu F + 10\Omega$ .

**Note 4:** Input DC bias voltage determines the maximum voltage swing of the input signal. Inputting a signal with a peak voltage of greater than the input DC bias voltage results in clipping.

**Note 5:** 1.8V logic compatible.

**Note 6:** Amplifier/inputs AC-coupled to GND.

**Note 7:** Testing performed at room temperature with  $10\Omega$  resistive load in series with  $1\mu F$  capacitive load connected across the BTL output for speaker amplifier. Mode transitions are controlled by SHDN.  $V_{CP}$  is the peak output transient expressed in dBV.

**Note 8:** Voltage gain is defined as:  $[V_{OUT+} - V_{OUT-}] / [V_{IN+} - V_{IN-}]$ .

**Note 9:**  $PVSS$  is forced to  $-3.6V$  to simulate boosted rail.

**Note 10:** Dynamic range is calculated by measuring the RMS voltage difference between a  $-60dBFS$  output signal and the noise floor, then adding 60dB. Full scale is defined as the output signal needed to achieve 1% THD+N.

$R_{IN-}$  and  $R_{FB-}$  have 0.5% tolerance. The Class G output stage has 12dB of gain. Any gain or attenuation at the input stage will add to or subtract from the gain of the Class G output.

# 14VP-P, Class G Ceramic Speaker Driver

## Typical Operating Characteristics

( $V_{CC} = V_{CPVDD} = V_{SHDN} = 3.6V$ ,  $V_{GND} = V_{CPGND} = 0V$ ,  $R_{IN+} = R_{IN-} = 10k\Omega$ ,  $R_{FB+} = R_{FB-} = 10k\Omega$ ,  $R_{FS} = 100k\Omega$ ,  $C_1 = 4.7\mu F$ ,  $C_2 = 10\mu F$ ,  $Z_L = 1\mu F + 10\Omega$ ; load terminated between OUT+ and OUT-, unless otherwise stated;  $T_A = T_{MIN}$  to  $T_{MAX}$ , unless otherwise noted. Typical values are at  $T_A = +25^\circ C$ .) (Notes 1, 2)

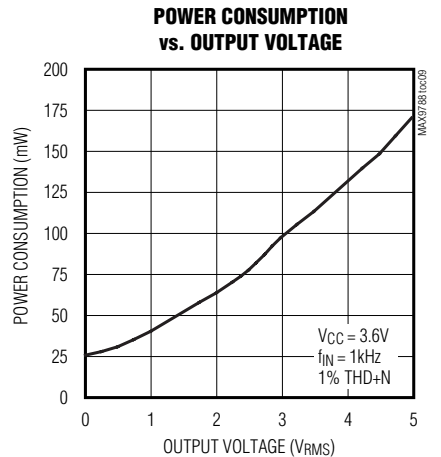
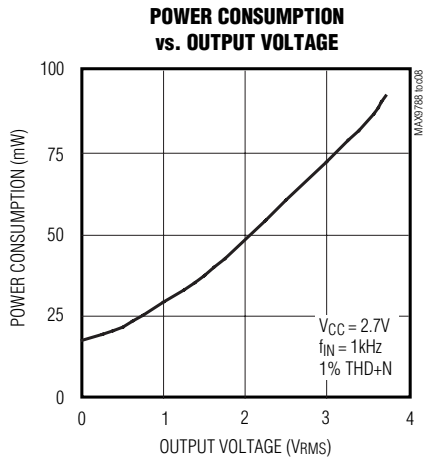
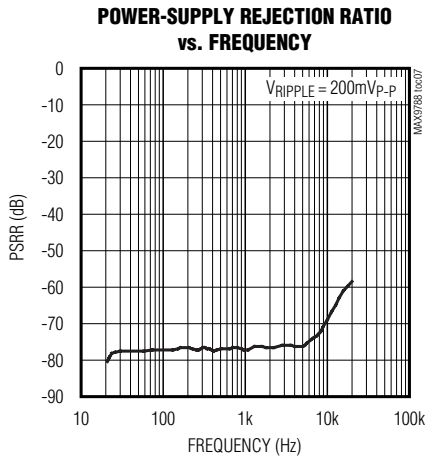
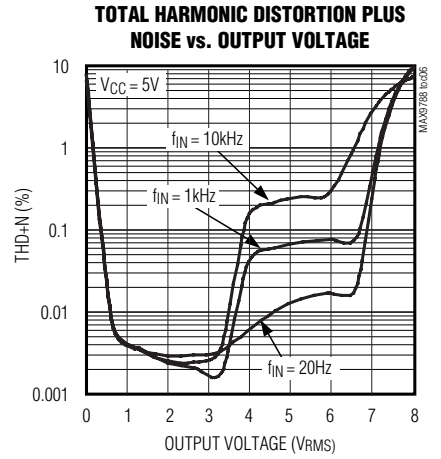
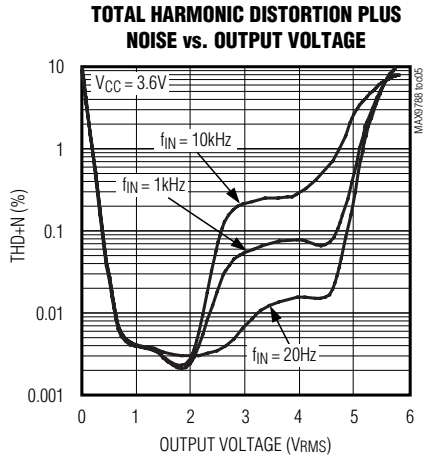
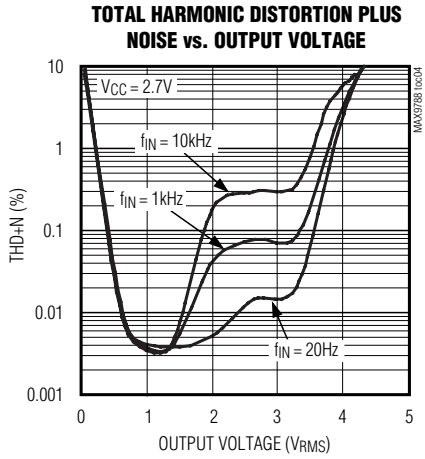
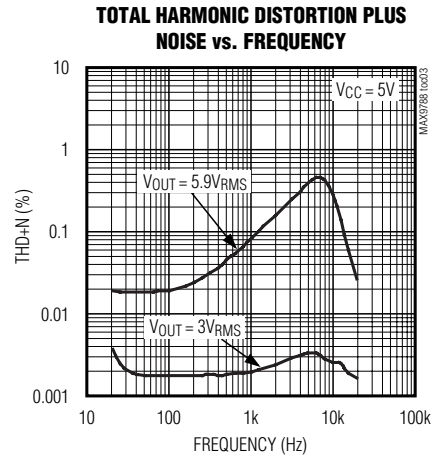
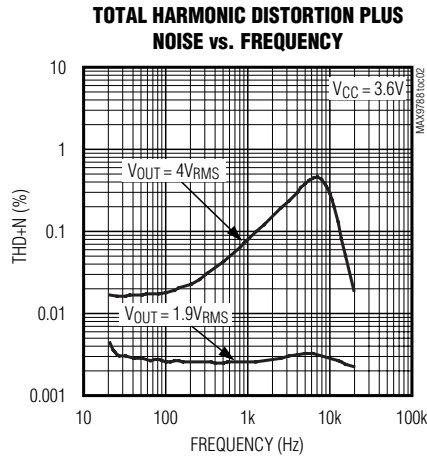
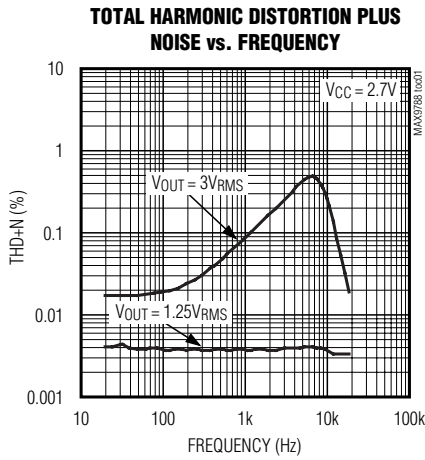

# 14VP-P, Class G Ceramic Speaker Driver

## Typical Operating Characteristics (continued)

( $V_{CC} = V_{CPVDD} = V_{SHDN} = 3.6V$ ,  $V_{GND} = V_{CPGND} = 0V$ ,  $R_{IN+} = R_{IN-} = 10k\Omega$ ,  $R_{FB+} = R_{FB-} = 10k\Omega$ ,  $R_{FS} = 100k\Omega$ ,  $C1 = 4.7\mu F$ ,  $C2 = 10\mu F$ ,  $Z_L = 1\mu F + 10\Omega$ ; load terminated between  $OUT+$  and  $OUT-$ , unless otherwise stated;  $T_A = T_{MIN}$  to  $T_{MAX}$ , unless otherwise noted. Typical values are at  $T_A = +25^\circ C$ .) (Notes 1, 2)

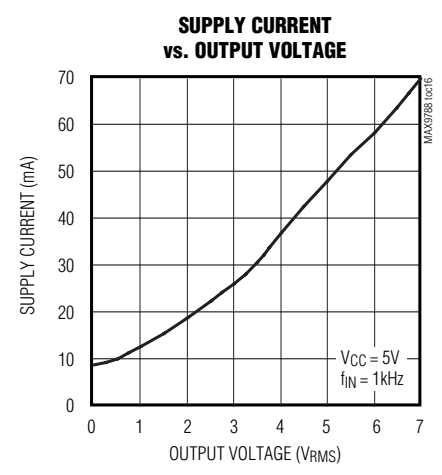
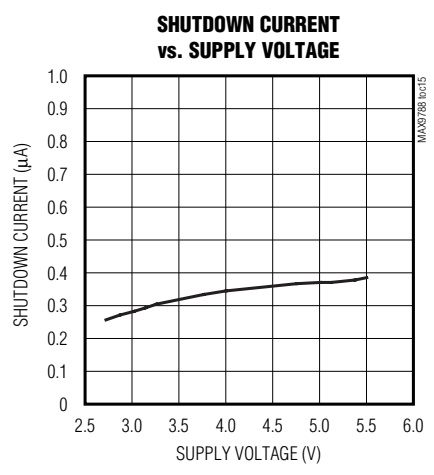
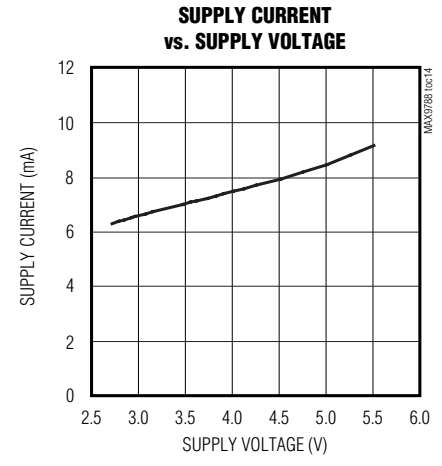
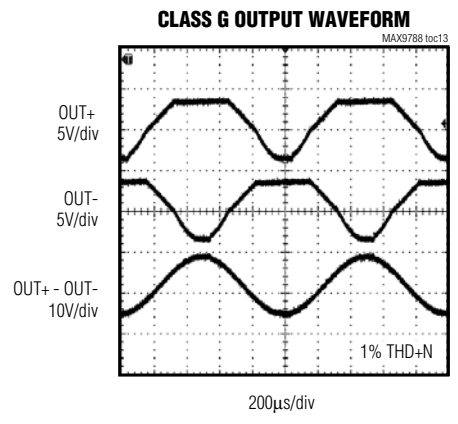
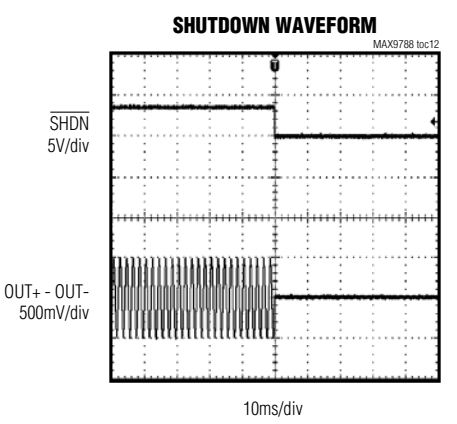
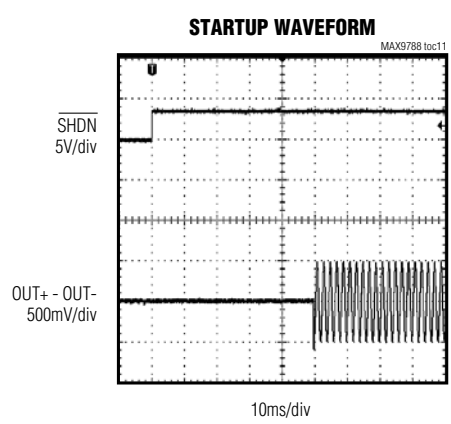
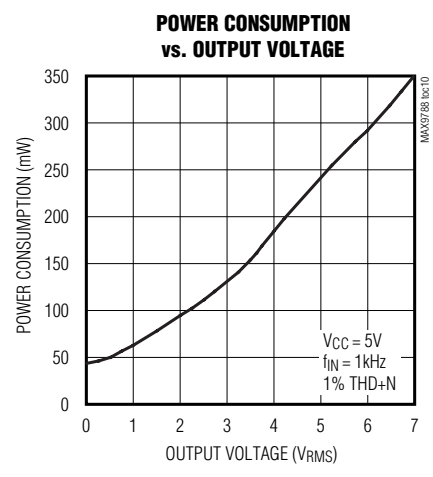

# 14VP-P, Class G Ceramic Speaker Driver

## Typical Operating Characteristics (continued)

( $V_{CC} = V_{CPVDD} = V_{SHDN} = 3.6V$ ,  $V_{GND} = V_{CPGND} = 0V$ ,  $R_{IN+} = R_{IN-} = 10k\Omega$ ,  $R_{FB+} = R_{FB-} = 10k\Omega$ ,  $R_{FS} = 100k\Omega$ ,  $C_1 = 4.7\mu F$ ,  $C_2 = 10\mu F$ ,  $Z_L = 1\mu F + 10\Omega$ ; load terminated between OUT+ and OUT-, unless otherwise stated;  $T_A = T_{MIN}$  to  $T_{MAX}$ , unless otherwise noted. Typical values are at  $T_A = +25^\circ C$ .) (Notes 1, 2)

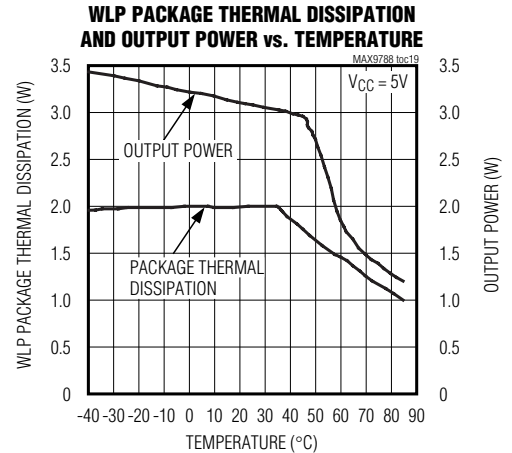
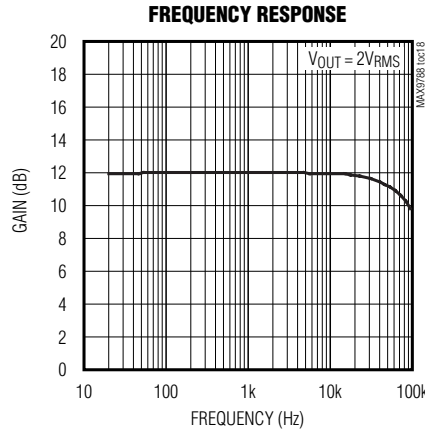
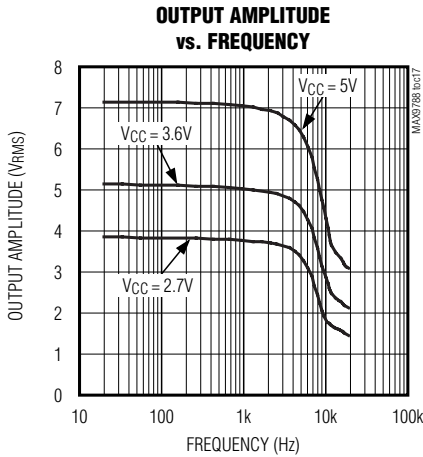

## Pin Description

PIN		NAME	FUNCTION
TQFN	WLP		
1	B2	SHDN	Shutdown
2, 5, 6, 8, 11, 17, 19, 23, 25, 28	—	N.C.	No Connection. No internal connection.
3	A2	C1P	Charge-Pump Flying Capacitor, Positive Terminal. Connect a 4.7μF capacitor between C1P and C1N.
4	A3	CPVDD	Charge-Pump Positive Supply
7	A4	FB-	Negative Amplifier Feedback
9	A5	IN-	Negative Amplifier Input
10	B5	IN+	Positive Amplifier Input
12	B4	FB+	Positive Amplifier Feedback
13	C5	FS	Charge-Pump Frequency Set. Connect a 100kΩ resistor from FS to GND to set the charge-pump switching frequency.
14, 22	D1, D5	VCC	Supply Voltage. Bypass with a 10μF capacitor to GND.
15, 21	C2, C4	SVSS	Amplifier Negative Power Supply. Connect to PVSS.
16	D4	OUT-	Negative Amplifier Output
18	D3	GND	Ground
20	D2	OUT+	Positive Amplifier Output
24	C1	PVSS	Charge-Pump Output. Connect a 10μF capacitor between PVSS and CPGND.
26	B1	C1N	Charge-Pump Flying Capacitor, Negative Terminal. Connect a 4.7μF capacitor between C1N and C1P.
27	A1	CPGND	Charge-Pump Ground. Connect to GND.
EP	—	EP	Exposed Pad. Connect the TQFN EP to GND.

# 14VP-P, Class G Ceramic Speaker Driver

## Detailed Description

The MAX9788 Class G power amplifier with inverting charge pump is the latest in linear amplifier technology. The Class G output stage offers improved performance over a Class AB amplifier while increasing efficiency to extend battery life. The integrated inverting charge pump generates a negative supply capable of delivering greater than 700mA.

The Class G output stage and the inverting charge pump allow the MAX9788 to deliver a 14VP-P voltage swing, up to two times greater than a traditional single-supply linear amplifier.

## Class G Operation

The MAX9788 Class G amplifier is a linear amplifier that operates within a low ( $V_{CC}$  to GND) and high ( $V_{CC}$  to  $SV_{SS}$ ) supply range. Figure 1 illustrates the transition from the low to high supply range. For small signals, the device operates within the lower ( $V_{CC}$  to GND) supply range. In this range, the operation of the device is identical to a traditional single-supply Class AB amplifier where:

$$I_{LOAD} = I_{N1}$$

As the output signal increases so a wider supply is needed, the device begins its transition to the higher supply range ( $V_{CC}$  to  $SV_{SS}$ ) for the large signals. To ensure a seamless transition between the low and high supply ranges, both of the lower transistors are on so that:

$$I_{LOAD} = I_{N1} + I_{N2}$$

As the output signal continues to increase, the transition to the high supply is complete. The device then operates in the higher supply range, where the operation of the device is identical to a traditional dual-supply Class AB amplifier where:

$$I_{LOAD} = I_{N2}$$

During operation, the output common-mode voltage of the MAX9788 adjusts dynamically as the device transitions between supply ranges.

Utilizing a Class G output stage with an inverting charge pump allows the MAX9788 to realize a 20VP-P output swing with a 5V supply.

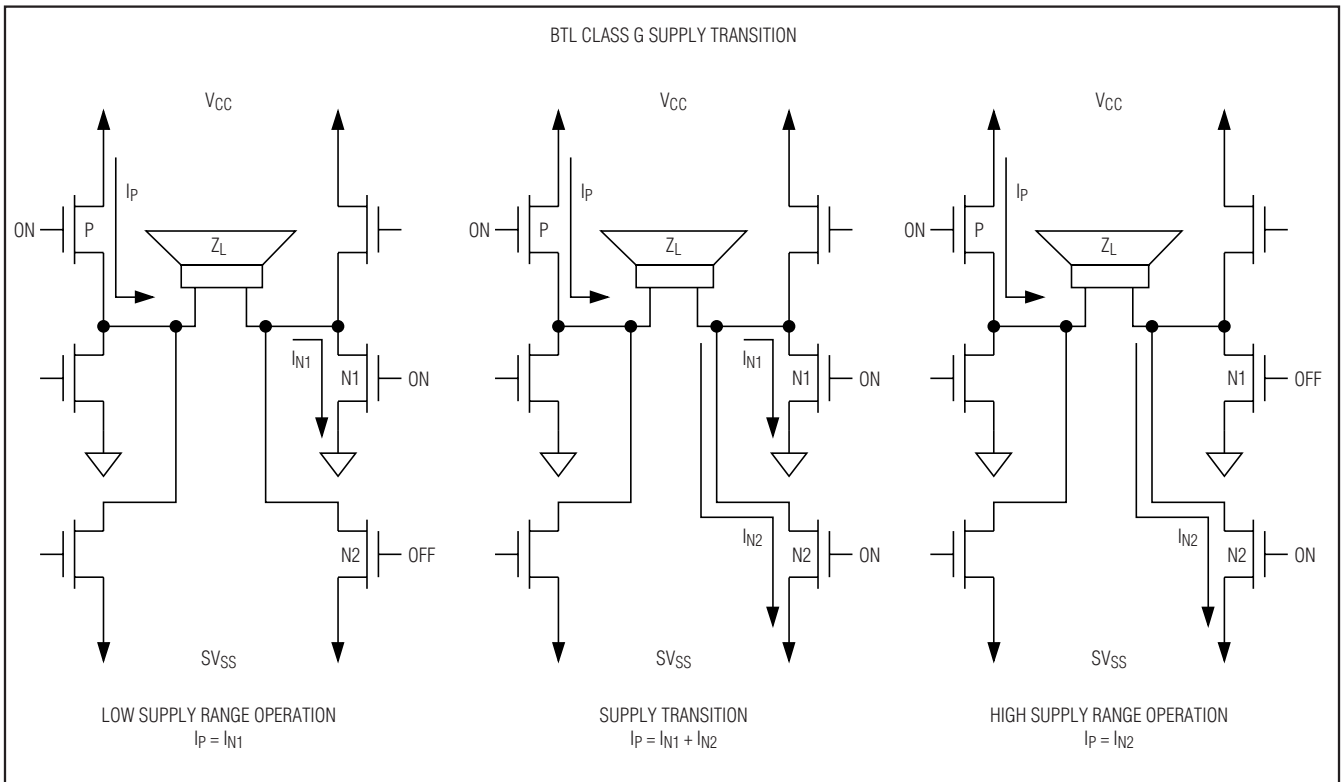

Figure 1. Class G Supply Transition

# 14VP-P, Class G Ceramic Speaker Driver

## Inverting Charge Pump

The MAX9788 features an integrated charge pump with an inverted supply rail that can supply greater than 700mA over the positive 2.7V to 5.5V supply range. In the case of the MAX9788, the charge pump generates the negative supply rail (PVSS) needed to create the higher supply range, which allows the output of the device to operate over a greater dynamic range as the battery supply collapses over time.

## Shutdown Mode

The MAX9788 has a shutdown mode that reduces power consumption and extends battery life. Driving  $\overline{\text{SHDN}}$  low places the MAX9788 in a low-power (0.3 $\mu$ A) shutdown mode. Connect  $\overline{\text{SHDN}}$  to VCC for normal operation.

## Click-and-Pop Suppression

The MAX9788 Class G amplifier features Maxim's comprehensive, industry-leading click-and-pop suppression. During startup, the click-and-pop suppression circuitry eliminates any audible transient sources internal to the device.

## Applications Information

### Differential Input Amplifier

The MAX9788 features a differential input configuration, making the device compatible with many CODECs, and offering improved noise immunity over a single-ended input amplifier. In devices such as PCs, noisy digital signals can be picked up by the amplifier's input traces. The signals appear at the amplifier's inputs as common-mode noise. A differential input amplifier amplifies the difference of the two inputs and signals common to both inputs are canceled out. When configured for differential inputs, the voltage gain of the MAX9788 is set by:

$$A_V = 20 \log \left[ 4 \times \left( \frac{R_{FB-}}{R_{IN-}} \right) \right] \text{ (dB)}$$

where  $A_V$  is the desired voltage gain in dB.  $R_{IN+}$  should be equal to  $R_{IN-}$ , and  $R_{FB+}$  should be equal to  $R_{FB-}$ . The Class G output stage has a fixed gain of 4V/V (12dB). Any gain or attenuation set by the external input stage resistors will add to or subtract from this fixed gain. See Figure 2.

In differential input configurations, the common-mode rejection ratio (CMRR) is primarily limited by the external resistor and capacitor matching. Ideally, to achieve the highest possible CMRR, the following external components should be selected where:

$$\frac{R_{FB+}}{R_{IN+}} = \frac{R_{FB-}}{R_{IN-}}$$

and

$$C_{IN+} = C_{IN-}$$

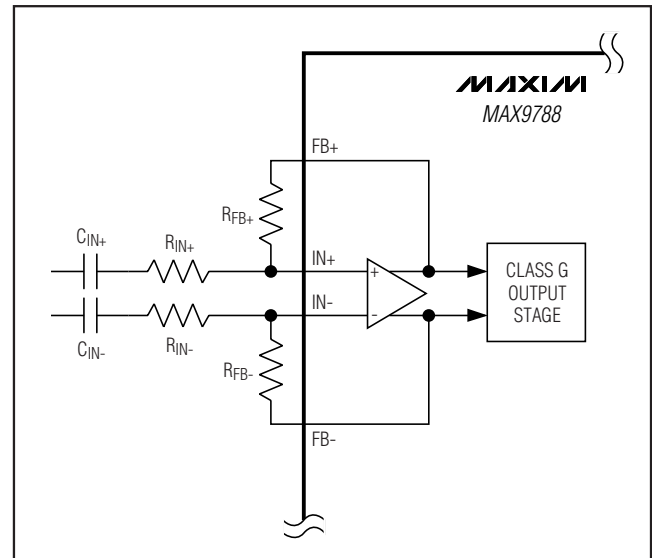

Figure 2. Gain Setting



# 14VP-P, Class G Ceramic Speaker Driver

## Driving a Ceramic Speaker

Applications that require thin cases, such as today's mobile phones, demand that external components have a small form factor. Dynamic loudspeakers that use a cone and voice coil typically cannot conform to the height requirements. The option for these applications is to use a ceramic/piezoelectric loudspeaker.

Ceramic speakers are much more capacitive than a conventional loudspeaker. Typical capacitance values for such a speaker can be greater than 1 $\mu$ F. High peak-to-peak voltage drive is required to achieve acceptable sound pressure levels. The high output voltage requirement coupled with the capacitive nature of the speaker demand that the amplifier supply much more current at high frequencies than at lower frequencies. Above 10kHz, the typical speaker impedance can be less than 16 $\Omega$ .

The MAX9788 is ideal for driving a capacitive ceramic speaker. The high charge-pump current limit allows for a flat frequency response out to 20kHz while maintaining high output voltage swings. See the Frequency Response graph in the *Typical Operating Characteristics*. Figure 3 shows a typical circuit for driving a ceramic speaker.

A 10 $\Omega$  series resistance is recommended between the amplifier output and the ceramic speaker load to ensure the output of the amplifier sees some fixed resistance at high frequencies when the speaker is essentially an electrical short.

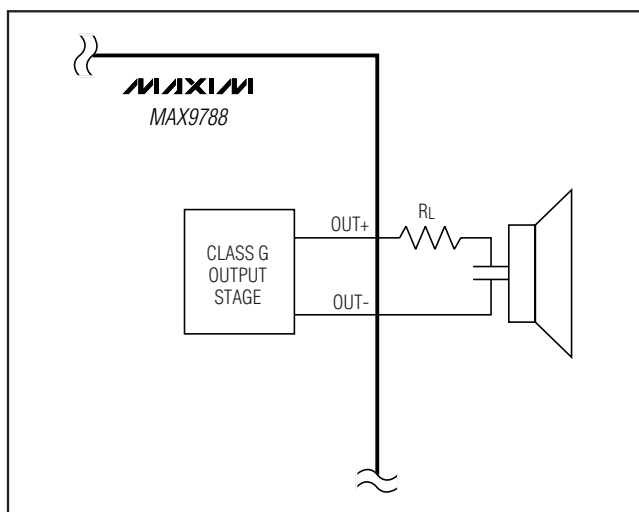

Figure 3. Driving a Ceramic Speaker

## Component Selection

### Input-Coupling Capacitor

The AC-coupling capacitors ( $C_{IN\_}$ ) and input resistors ( $R_{IN\_}$ ) form highpass filters that remove any DC bias from an input signal (see the *Functional Diagram/Typical Operating Circuit*).  $C_{IN\_}$  blocks DC voltages from the amplifier input. The -3dB point of the highpass filter, assuming zero source impedance due to the input signal source, is given by:

$$f_{-3dB} = \frac{1}{2\pi \times R_{IN\_} \times C_{IN\_}} (\text{Hz})$$

Ceramic speakers generally perform best at frequencies greater than 1kHz. Low frequencies can deflect the piezoelectric speaker element so that high frequencies cannot be properly reproduced. This can cause distortion in the speaker's usable frequency band. Select a  $C_{IN}$  so the  $f_{-3dB}$  closely matches the low frequency response of the ceramic speaker. Use capacitors with low-voltage coefficient dielectrics. Aluminum electrolytic, tantalum, or film dielectric capacitors are good choices for AC-coupling capacitors. Capacitors with high-voltage coefficients, such as ceramics (non-C0G dielectrics), can result in increased distortion at low frequencies.

### Charge-Pump Capacitor Selection

Use capacitors with an ESR less than 50m $\Omega$  for optimum performance. Low-ESR ceramic capacitors minimize the output resistance of the charge pump. For best performance over the extended temperature range, select capacitors with an X7R dielectric.

### Flying Capacitor (C1)

The value of the flying capacitor (C1) affects the load regulation and output resistance of the charge pump. A C1 value that is too small degrades the device's ability to provide sufficient current drive. Increasing the value of C1 improves load regulation and reduces the charge-pump output resistance to an extent. Above 1 $\mu$ F, the on-resistance of the switches and the ESR of C1 and C2 dominate. A 4.7 $\mu$ F capacitor is recommended.

# 14VP-P, Class G Ceramic Speaker Driver

## Hold Capacitor (C2)

The output capacitor value and ESR directly affect the ripple at PVSS. Increasing C2 reduces output ripple. Likewise, decreasing the ESR of C2 reduces both ripple and output resistance. A 10 $\mu$ F capacitor is recommended.

## Charge-Pump Frequency Set Resistor (RFS)

The charge pump operates in two modes. When the charge pump is loaded below 100mA, it operates in a slow mode where the oscillation frequency is reduced to 1/4 of its normal operating frequency. Once loaded, the charge-pump oscillation frequency returns to normal operation. In applications where the design may be sensitive to the operating charge-pump oscillation frequency, the value of the external resistor RFS can be changed to adjust the charge-pump oscillation frequency shown in Figure 4. A 100k $\Omega$  resistor is recommended.

## Ceramic Speaker Impedance Characteristics

A 1 $\mu$ F capacitor is a good model for the ceramic speaker as it best approximates the impedance of a ceramic speaker over the audio band. When selecting a capacitor to simulate a ceramic speaker, the voltage rating or the capacitor must be equal to or higher than the expected output voltage swing. See Figure 5.

## Series Load Resistor

The capacitive nature of the ceramic speaker results in very low impedances at high frequencies. To prevent the ceramic speaker from shorting the MAX9788 output at high frequencies, a series load resistor must be used. The output load resistor and the ceramic speaker create a lowpass filter. To set the rolloff frequency of the output filter, the approximate capacitance of the speaker must be known. This information can be obtained from bench testing or from the ceramic speaker manufacturer. A series load resistor greater than 10 $\Omega$  is recommended. Set the lowpass filter cutoff frequency with the following equation:

$$f_{LP} = \frac{1}{2\pi \times R_L \times C_{SPEAKER}} \text{ (Hz)}$$

## WLP Applications Information

For the latest application details on WLP construction, dimensions, tape carrier information, PCB techniques, bump-pad layout, and recommended reflow temperature profile, as well as the latest information on reliability testing results, go to the Maxim website at [www.maximic.com/ucsp](http://www.maximic.com/ucsp) for the application note, *UCSP—A Wafer-Level Chip-Scale Package*.

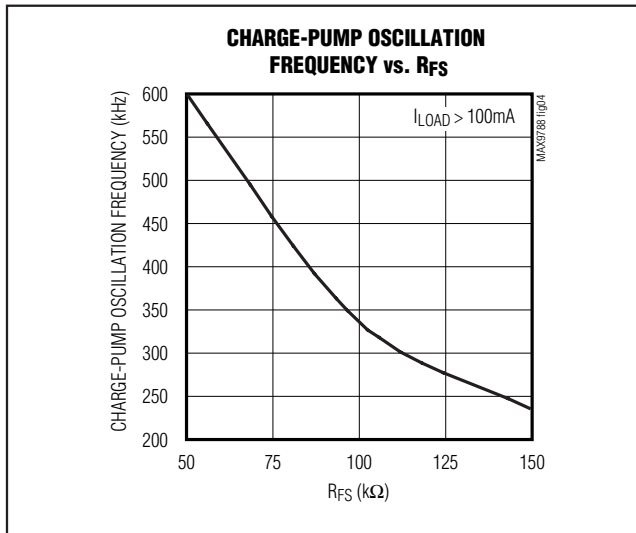

Figure 4. Charge-Pump Oscillation Frequency vs. RFS

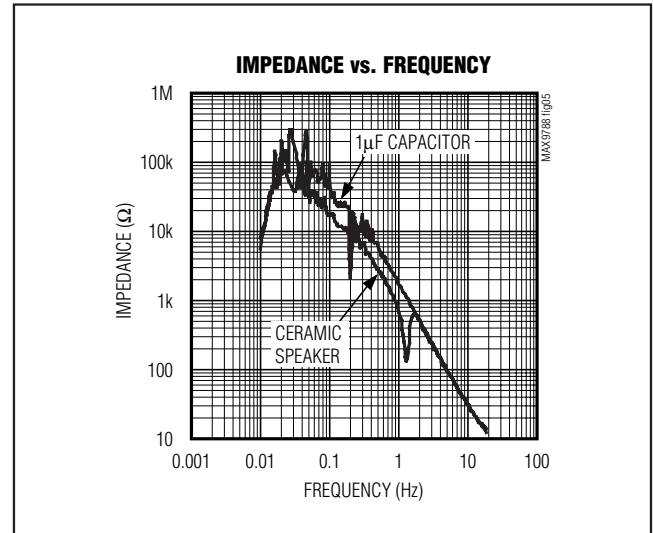
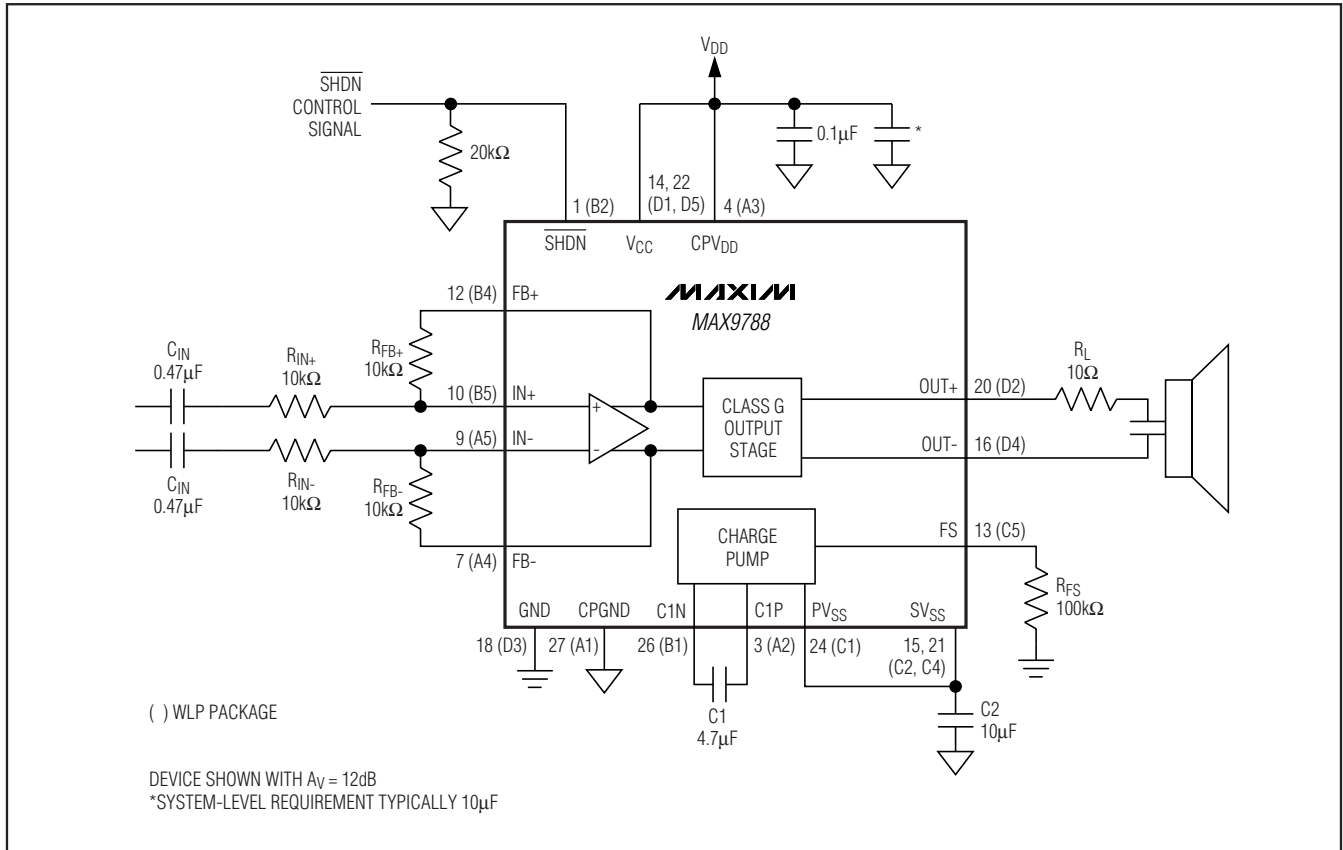

Figure 5. Ceramic Speaker and Capacitor Impedance

# 14VP-P, Class G Ceramic Speaker Driver

## Typical Application Circuit/Functional Diagram

MAX9788



# 14VP-P, Class G Ceramic Speaker Driver

## Pin Configurations

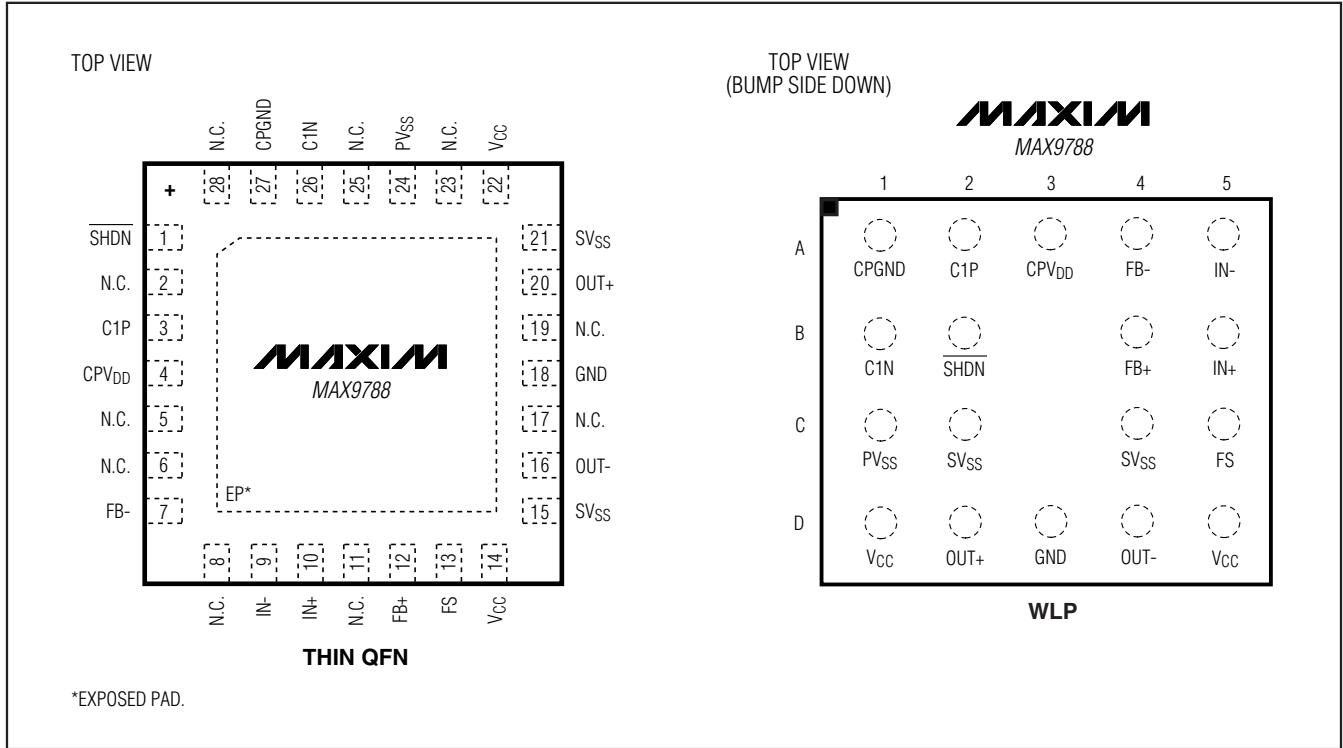

### Package Information

For the latest package outline information and land patterns, go to [www.maxim-ic.com/packages](http://www.maxim-ic.com/packages).

PACKAGE TYPE	PACKAGE CODE	DOCUMENT NO.
20 WLP	W202A2+1	<a href="#">21-0059</a>
28 TQFN	T2844-1	<a href="#">21-0139</a>

### Chip Information

PROCESS: BiCMOS

# 14VP-P, Class G Ceramic Speaker Driver

## Revision History

REVISION NUMBER	REVISION DATE	DESCRIPTION	PAGES CHANGED
0	12/06	Initial release	—
1	11/07	Include tape and reel note, edit <i>Absolute Maximum Ratings</i> , update TQFN package outline	1, 2, 13, 14
2	2/08	Replaced USCP with WLP package throughout data sheet including new WLP package outline, added new TOC 19 and Note 1	1, 2, 3, 6, 10, 11, 12, 15, 16
3	5/08	Updated <i>Typical Application Circuit</i> and corrected stylistic errors	1–6, 11

MAX9788

Maxim cannot assume responsibility for use of any circuitry other than circuitry entirely embodied in a Maxim product. No circuit patent licenses are implied. Maxim reserves the right to change the circuitry and specifications without notice at any time.

Maxim Integrated Products, 120 San Gabriel Drive, Sunnyvale, CA 94086 408-737-7600 \_\_\_\_\_ 13