

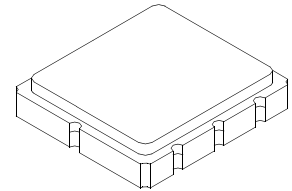



SF2289C

**155 MHz
SAW Filter**



SM5050-8

- Low Loss SAW Filter
- 5.0 x 5.0 mm Surface-mount Case
- Complies with Directive 2002/95/EC (RoHS) 

Absolute Maximum Ratings

Rating	Value	Units
Maximum Incident Power in Passband	0	dBm
Maximum DC Voltage on any Non-ground Terminal	10	V
Storage Temperature Range in Tape and Reel	-40 to +85	°C
Maximum Soldering Profile	265 °C for 10 s	

Electrical Characteristics

Characteristic	Sym	Notes	Min	Typ	Max	Units
Center Frequency	f_C	1	155			MHz
Insertion Loss, $f_C \pm 4$ MHz	IL	1			6.5	dB
Rejection Referenced to IL_{MIN} :		1, 3				dB
$f_C - 38.8$ to $f_C - 100$ MHz			50			
$f_C + 38.8$ to $f_C + 100$ MHz			42			
Operating Temperature Range	T_A	1	-10		+50	°C
Input Impedance at f_C			263 Ω 8.7 pF			
Output Impedance at f_C			685 Ω 9.1 pF			
Case Style		6	SM5050-8 5 x 5 mm Nominal Footprint			
Lid Symbolization			A36			

50 ohm Matching Network

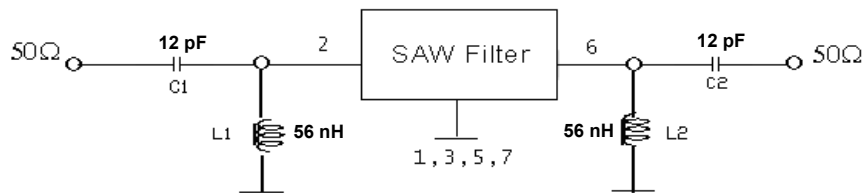

CAUTION: Electrostatic Sensitive Device. Observe precautions for handling.

Notes:

1. Unless noted otherwise, all specifications apply over the operating temperature range with filter soldered to the specified demonstration board with impedance matching to 50 Ω and measured with 50 Ω network analyzer.
2. Unless noted otherwise, all frequency specifications are referenced to the nominal center frequency, f_C .
3. Rejection is measured as attenuation below the minimum IL point in the passband. Rejection in final user application is dependent on PCB layout and external impedance matching design. See Application Note No. 42 for details.
4. "LRIP" or "L" after the part number indicates "low rate initial production" and "ENG" or "E" indicates "engineering prototypes."
5. The design, manufacturing process, and specifications of this filter are subject to change.
6. Tape and Reel Standard ANSI / EIA 481.
7. Either Port 1 or Port 2 may be used for either input or output in the design. However, impedances and impedance matching may vary between Port 1 and Port 2, so that the filter must always be installed in one direction per the circuit design.
8. US and international patents may apply.
9. RFM, stylized RFM logo, and RF Monolithics, Inc. are registered trademarks of RF Monolithics, Inc.

Filter Broadband Plot

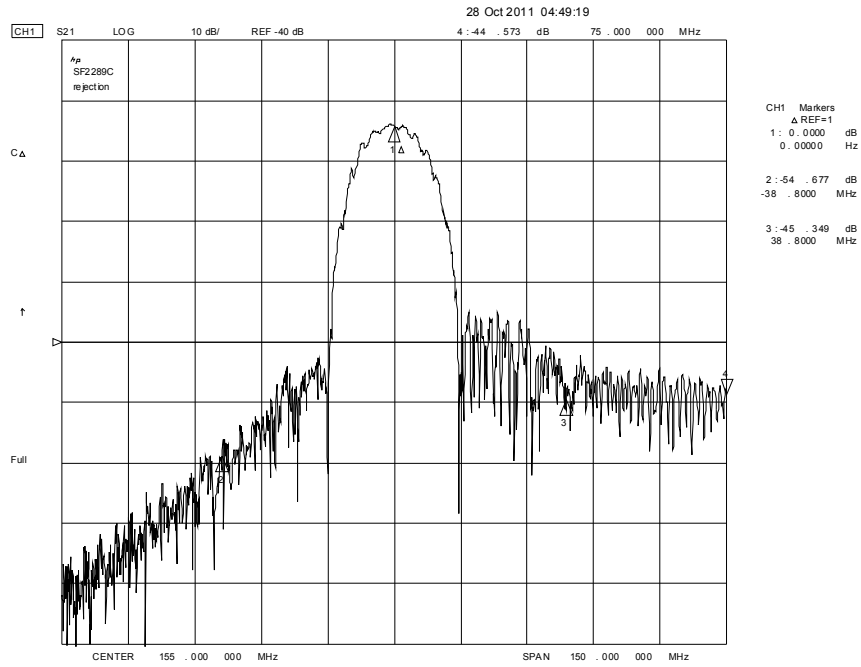

Filter Impedance and Passband Plot

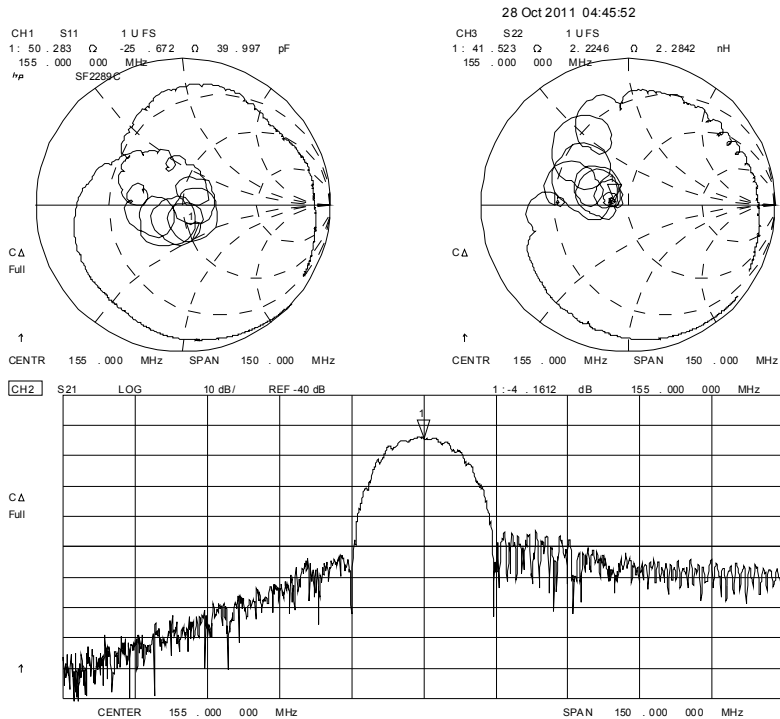

SM5050-8 Surface-Mount 8-Terminal Ceramic Case 5.0 X 5.0 mm Nominal Footprint

Case Dimensions

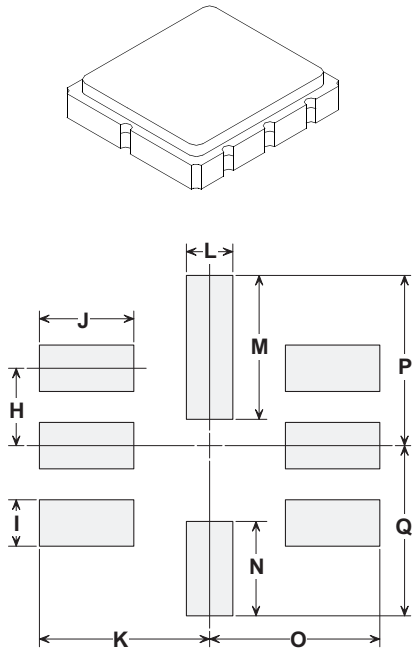

PCB Footprint

Dimension	mm			Inches		
	Min	Nom	Max	Min	Nom	Max
A	4.80	5.00	5.20	0.189	0.197	0.205
B	4.80	5.00	5.20	0.189	0.197	0.205
C	1.30	1.50	1.70	0.050	0.060	0.067
D	1.98	2.08	2.18	0.078	0.082	0.086
E	1.07	1.17	1.27	0.042	0.046	0.050
F	0.50	0.64	0.70	0.020	0.025	0.028
G	2.39	2.54	2.69	0.094	0.100	0.106
H		1.27			0.050	
I		0.76			0.030	
J		1.55			0.061	
K		2.79			0.110	
L		0.76			0.030	
M		2.36			0.093	
N		1.55			0.061	
O		2.79			0.110	
P		2.79			0.110	
Q		2.79			0.110	

Case Materials

Materials	
Solder Pad Plating	0.3 to 1.0 μm Gold over 1.27 to 8.89 μm Nickel
Lid Plating	2.0 to 3.0 μm Nickel
Body	Al_2O_3 Ceramic
	Pb Free

Electrical Connections

Connection		Terminals
Port 1	Input	2
Port 2	Output	6
	Ground	All others

Dot indicates Pin 1

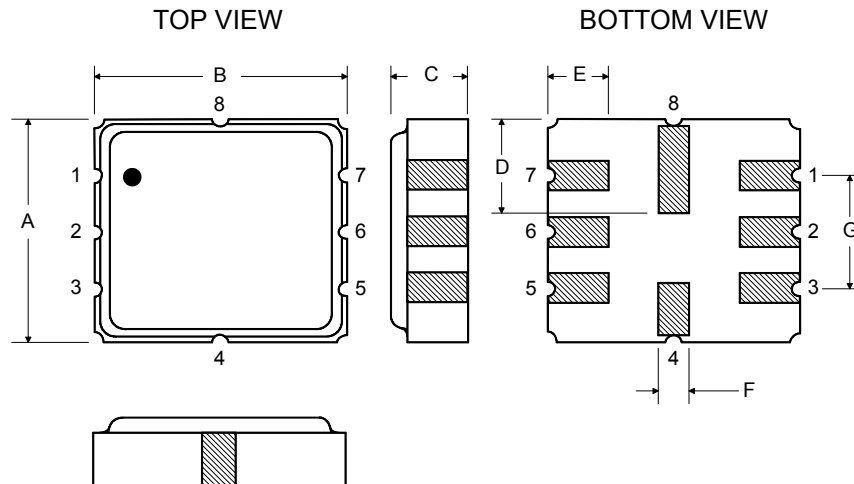

Tape and Reel Specifications

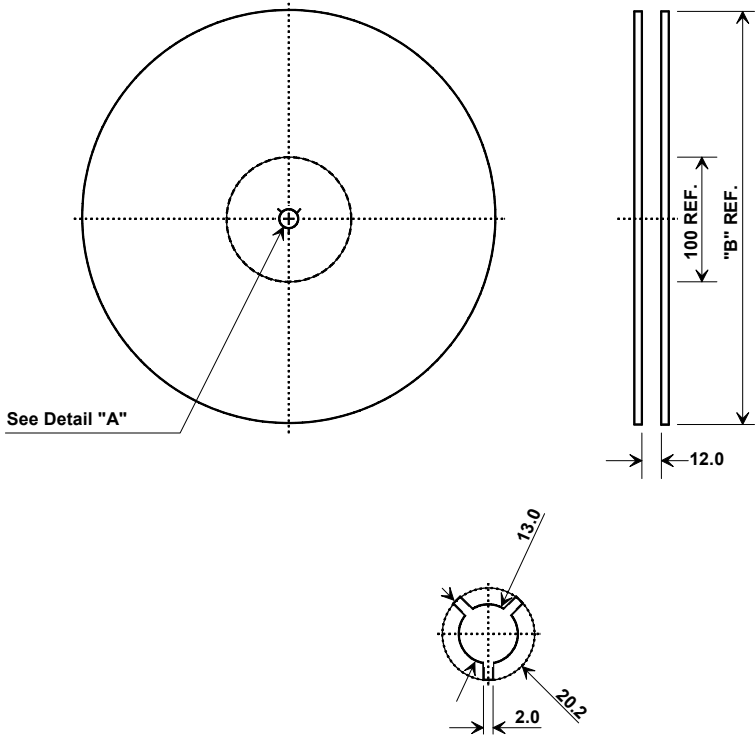

"B"		Quantity Per Reel
Nominal Size		
Inches	millimeters	
7	178	500
13	330	3000

COMPONENT ORIENTATION and DIMENSIONS

Carrier Tape Dimensions	
Ao	5.3 mm
Bo	5.3 mm
Ko	2.0 mm
Pitch	8.0 mm
W	12.0 mm

