

TECHNICAL CHARACTERISTICS

MATERIAL
 INSULATOR: PBT
 COLOR: WHITE
 CONTACT MATERIAL: COPPER ALLOYS
 CONTACT TYPE: STAMPED
 CONTACT PLATING: SELECTIVE GOLD
 SHIELDING: BRASS Ni PLATED
 QUALITY CLASS: 1500 MATING CYCLES

ENVIRONMENTAL
 OPERATING TEMPERATURE: -40 UP TO 105°C
 FLAMABILITY RATING: UL94-V0
 COMPLIANCE: LEAD FREE AND ROHS

ELECTRICAL
 CURRENT RATING: 1.5A Max
 WORKING VOLTAGE: 30V
 INSULATOR RESISTANCE: >1000 MOHM
 DIELECTRIC WITHSTANDING VOLTAGE: 750V AC/MN
 CONTACT RESISTANCE: 20 mOHM MAX

STANDARD
 CERTIFIED: E323964 / MODEL NUMBER 614-x350

SOLDERING
 WAVE PROCESS ONLY

PACKAGING
 TRAY

RoHS Compliant

PROJECTION:

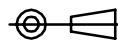

GENERAL TOLERANCE

.X = +/- 0.2
 .XX = +/- 0.15



APPROVAL: RJ

UNIT: MM

DESCRIPTION: USB 2.0 TYPE A VERTICAL

SIZE

APPROVAL: GG

SCALE:

WERI PART NO: 614 004 135 023

A4

APPROVAL: GG

SHEET: 1/2

REV DATE FILE BY

DRAW: PEARL

J	15-FEB-13	DESIGNATION	AR
I	19-DEC-11	DRAWING	GG
H	08-NOV-11	CURRENT RATING	GG
REV	DATE	FILE	BY

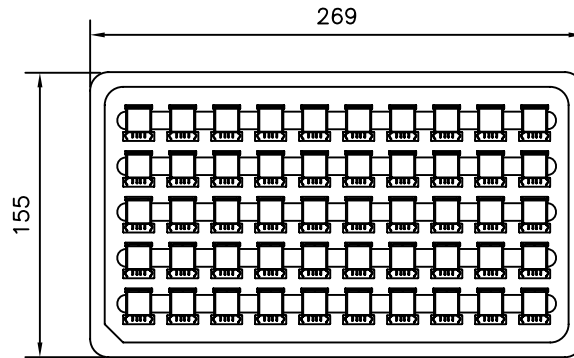
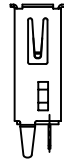
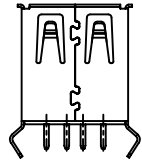
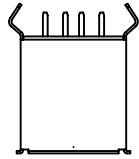
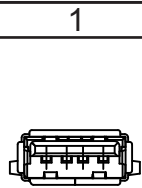

Note:
 1.Dimension:
 Tray Size: 269(L)X155(W)X8.0(H) (mm)
 Carton Size:322X285X350(mm)

Pin.	Pcs/Tray	Tray/Carton	Pcs/Carton
04	50	70	3500

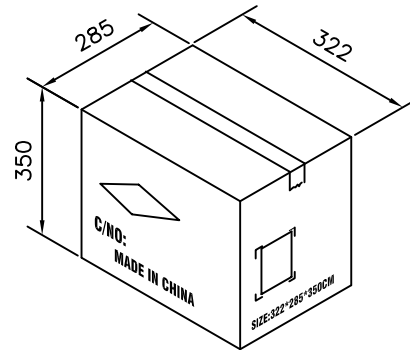
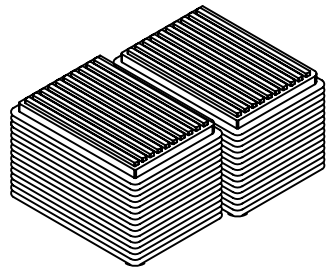

84 Trays

RoHS Compliant			
G			
F			
E			
D			
C			
B			
A			
REV	DATE	FILE	BY

PROJECTION:

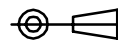

APPROVAL: RJ

GENERAL TOLERANCE

.X = +/- 0.2
 .XX = +/- 0.15

UNIT: MM

SCALE:

SHEET: 1/2

DRAW: PEARL



DESCRIPTION: USB TYPE A VERTICAL

WERI PART NO: 614 004 135 023

SIZE

A4