

Sideview LED, 5 mm Tinted Diffused

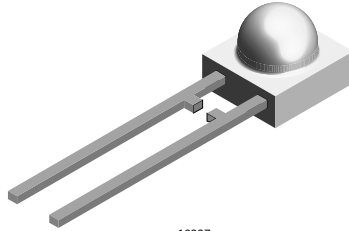

FEATURES

- Even luminance of the emitting surface
- Wide viewing angle
- Yellow and green color categorized
- For DC and pulse operation
- Lead (Pb)-free component
- Component in accordance to RoHS 2002/95/EC and WEEE 2002/96/EC



PRODUCT GROUP AND PACKAGE DATA

- Product group: LED
- Package: side view
- Product series: standard
- Angle of half intensity: $\pm 80^\circ$

APPLICATIONS

- Indicating and illumination purposes

PARTS TABLE

| PART | COLOR, LUMINOUS INTENSITY | TECHNOLOGY |
|----------|------------------------------|--------------|
| TLPR5600 | Red, $I_V > 1$ mcd | GaAsP on GaP |
| TLPH5600 | Red, $I_V > 0.63$ mcd | GaAsP on GaP |
| TLPY5600 | Yellow, $I_V > 0.63$ mcd | GaAsP on GaP |
| TLPG5600 | Green, $I_V > 0.63$ mcd | GaP on GaP |
| TLPP5600 | Pure green, $I_V > 0.63$ mcd | GaP on GaP |

ABSOLUTE MAXIMUM RATINGS¹⁾ TLPR5600, TLPH5600, TLPY5600, TLPG5600, TLPP5600

| PARAMETER | TEST CONDITION | PART | SYMBOL | VALUE | UNIT |
|-----------------------------|------------------------------|----------|-----------|---------------|------------|
| Reverse voltage | | | V_R | 6 | V |
| DC Forward current | | TLPR5600 | I_F | 20 | mA |
| | | TLPH5600 | I_F | 30 | mA |
| | | TLPY5600 | I_F | 30 | mA |
| | | TLPG5600 | I_F | 30 | mA |
| | | TLPP5600 | I_F | 30 | mA |
| Surge forward current | $t_p \leq 10 \mu s$ | | I_{FSM} | 1 | A |
| Power dissipation | $T_{amb} \leq 60^\circ C$ | TLPR5600 | P_V | 60 | mW |
| | | TLPH5600 | P_V | 100 | mW |
| | | TLPY5600 | P_V | 100 | mW |
| | | TLPG5600 | P_V | 100 | mW |
| | | TLPP5600 | P_V | 100 | mW |
| Junction temperature | | | T_j | 100 | $^\circ C$ |
| Operating temperature range | | | T_{amb} | - 40 to + 100 | $^\circ C$ |
| Storage temperature range | | | T_{stg} | - 55 to + 100 | $^\circ C$ |
| Soldering temperature | $t \leq 5$ s, 2 mm from body | | T_{sd} | 260 | $^\circ C$ |



| ABSOLUTE MAXIMUM RATINGS¹⁾ TLPR5600, TLPH5600, TLPY5600, TLPG5600, TLPP5600 | | | | | |
|-----------------------------------------------------------------------------------------------|----------------|----------|------------|-------|------|
| PARAMETER | TEST CONDITION | PART | SYMBOL | VALUE | UNIT |
| Thermal resistance junction/ambient | | TLPR5600 | R_{thJA} | 500 | K |
| | | TLPH5600 | R_{thJA} | 400 | K/W |
| | | TLPY5600 | R_{thJA} | 400 | K/W |
| | | TLPG5600 | R_{thJA} | 400 | K/W |
| | | TLPP5600 | R_{thJA} | 400 | K/W |

Note:

¹⁾ $T_{amb} = 25\text{ }^{\circ}\text{C}$, unless otherwise specified

| OPTICAL AND ELECTRICAL CHARACTERISTICS¹⁾ TLPR5600, RED | | | | | | |
|--------------------------------------------------------------------------|-------------------------------|-------------|-----|----------|-----|------|
| PARAMETER | TEST CONDITION | SYMBOL | MIN | TYP. | MAX | UNIT |
| Luminous intensity ²⁾ | $I_F = 10\text{ mA}$ | I_V | 1 | 2.5 | | mcd |
| Dominant wavelength | $I_F = 10\text{ mA}$ | λ_d | | 630 | | nm |
| Peak wavelength | $I_F = 10\text{ mA}$ | λ_p | | 640 | | nm |
| Angle of half intensity | $I_F = 10\text{ mA}$ | φ | | ± 80 | | deg |
| Forward voltage | $I_F = 20\text{ mA}$ | V_F | | 2 | 3 | V |
| Reverse voltage | $I_R = 10\text{ }\mu\text{A}$ | V_R | 6 | 15 | | V |
| Junction capacitance | $V_R = 0, f = 1\text{ MHz}$ | C_j | | 50 | | pF |

Note:

¹⁾ $T_{amb} = 25\text{ }^{\circ}\text{C}$, unless otherwise specified

²⁾ in one packing unit $I_{Vmin}/I_{Vmax} \leq 0.5$

| OPTICAL AND ELECTRICAL CHARACTERISTICS¹⁾ TLPH5600, RED | | | | | | |
|--------------------------------------------------------------------------|-------------------------------|-------------|------|----------|-----|------|
| PARAMETER | TEST CONDITION | SYMBOL | MIN | TYP. | MAX | UNIT |
| Luminous intensity ²⁾ | $I_F = 10\text{ mA}$ | I_V | 0.63 | 1.5 | | mcd |
| Dominant wavelength | $I_F = 10\text{ mA}$ | λ_d | 612 | | 625 | nm |
| Peak wavelength | $I_F = 10\text{ mA}$ | λ_p | | 635 | | nm |
| Angle of half intensity | $I_F = 10\text{ mA}$ | φ | | ± 80 | | deg |
| Forward voltage | $I_F = 20\text{ mA}$ | V_F | | 2 | 3 | V |
| Reverse voltage | $I_R = 10\text{ }\mu\text{A}$ | V_R | 6 | 15 | | V |
| Junction capacitance | $V_R = 0, f = 1\text{ MHz}$ | C_j | | 50 | | pF |

Note:

¹⁾ $T_{amb} = 25\text{ }^{\circ}\text{C}$, unless otherwise specified

²⁾ in one packing unit $I_{Vmin}/I_{Vmax} \leq 0.5$

| OPTICAL AND ELECTRICAL CHARACTERISTICS¹⁾ TLPY5600, YELLOW | | | | | | |
|-----------------------------------------------------------------------------|-------------------------------|-------------|------|----------|-----|------|
| PARAMETER | TEST CONDITION | SYMBOL | MIN | TYP. | MAX | UNIT |
| Luminous intensity ²⁾ | $I_F = 10\text{ mA}$ | I_V | 0.63 | 1.5 | | mcd |
| Dominant wavelength | $I_F = 10\text{ mA}$ | λ_d | 581 | | 594 | nm |
| Peak wavelength | $I_F = 10\text{ mA}$ | λ_p | | 585 | | nm |
| Angle of half intensity | $I_F = 10\text{ mA}$ | φ | | ± 80 | | deg |
| Forward voltage | $I_F = 20\text{ mA}$ | V_F | | 2.4 | 3 | V |
| Reverse voltage | $I_R = 10\text{ }\mu\text{A}$ | V_R | 6 | 15 | | V |
| Junction capacitance | $V_R = 0, f = 1\text{ MHz}$ | C_j | | 50 | | pF |

Note:

¹⁾ $T_{amb} = 25\text{ }^{\circ}\text{C}$, unless otherwise specified

²⁾ in one packing unit $I_{Vmin}/I_{Vmax} \leq 0.5$

| OPTICAL AND ELECTRICAL CHARACTERISTICS¹⁾ TLP5600, GREEN | | | | | | |
|---------------------------------------------------------------------------|------------------------------|-------------|------|----------|-----|------|
| PARAMETER | TEST CONDITION | SYMBOL | MIN | TYP. | MAX | UNIT |
| Luminous intensity ²⁾ | $I_F = 10 \text{ mA}$ | I_V | 0.63 | 1.5 | | mcd |
| Dominant wavelength | $I_F = 10 \text{ mA}$ | λ_d | 562 | | 575 | nm |
| Peak wavelength | $I_F = 10 \text{ mA}$ | λ_p | | 565 | | nm |
| Angle of half intensity | $I_F = 10 \text{ mA}$ | ϕ | | ± 80 | | deg |
| Forward voltage | $I_F = 20 \text{ mA}$ | V_F | | 2.4 | 3 | V |
| Reverse voltage | $I_R = 10 \mu\text{A}$ | V_R | 6 | 15 | | V |
| Junction capacitance | $V_R = 0, f = 1 \text{ MHz}$ | C_j | | 50 | | pF |

Note:

¹⁾ $T_{amb} = 25 \text{ }^\circ\text{C}$, unless otherwise specified

²⁾ in one packing unit $I_{Vmin}/I_{Vmax} \leq 0.5$

| OPTICAL AND ELECTRICAL CHARACTERISTICS¹⁾ TLPP5600, PURE GREEN | | | | | | |
|---------------------------------------------------------------------------------|------------------------------|-------------|------|----------|-----|------|
| PARAMETER | TEST CONDITION | SYMBOL | MIN | TYP. | MAX | UNIT |
| Luminous intensity ²⁾ | $I_F = 10 \text{ mA}$ | I_V | 0.63 | 1.6 | | mcd |
| Dominant wavelength | $I_F = 10 \text{ mA}$ | λ_d | 555 | | 565 | nm |
| Peak wavelength | $I_F = 10 \text{ mA}$ | λ_p | | 555 | | nm |
| Angle of half intensity | $I_F = 10 \text{ mA}$ | ϕ | | ± 80 | | deg |
| Forward voltage | $I_F = 20 \text{ mA}$ | V_F | | 2.4 | 3 | V |
| Reverse voltage | $I_R = 10 \mu\text{A}$ | V_R | 6 | 15 | | V |
| Junction capacitance | $V_R = 0, f = 1 \text{ MHz}$ | C_j | | 50 | | pF |

Note:

¹⁾ $T_{amb} = 25 \text{ }^\circ\text{C}$, unless otherwise specified

²⁾ in one packing unit $I_{Vmin}/I_{Vmax} \leq 0.5$

TYPICAL CHARACTERISTICS

$T_{amb} = 25 \text{ }^\circ\text{C}$, unless otherwise specified

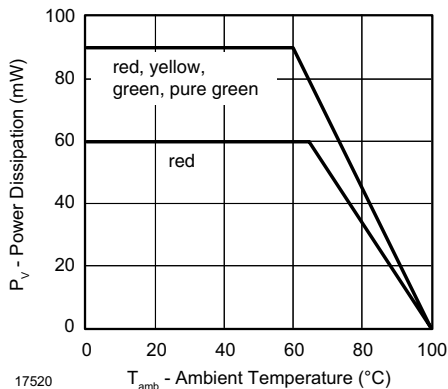

Figure 1. Power Dissipation vs. Ambient Temperature

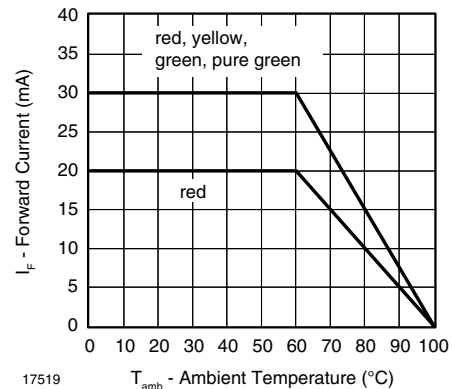

Figure 2. Forward Current vs. Ambient Temperature

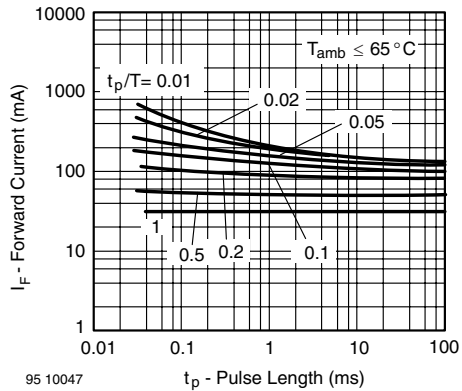

Figure 3. Forward Current vs. Pulse Length

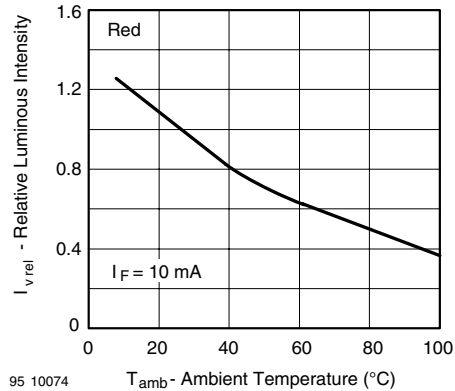

Figure 6. Rel. Luminous Intensity vs. Ambient Temperature

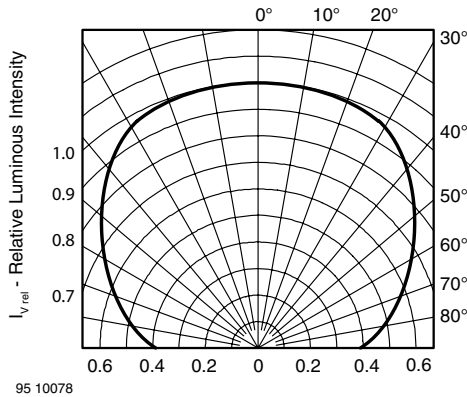

Figure 4. Rel. Luminous Intensity vs. Angular Displacement

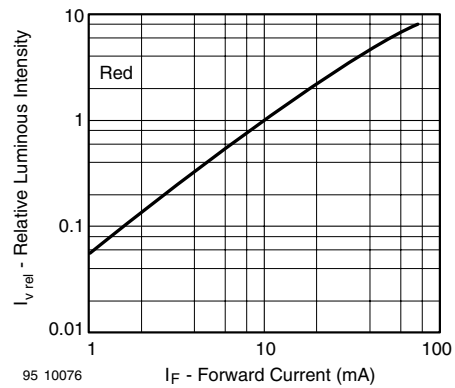

Figure 7. Relative Luminous Intensity vs. Forward Current

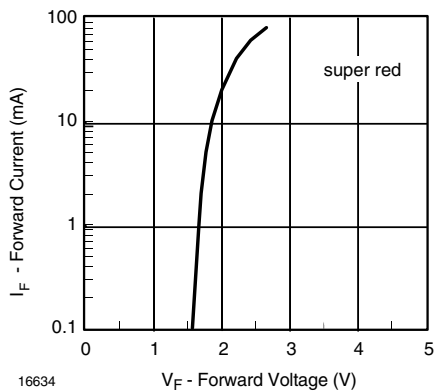

Figure 5. Forward Current vs. Forward Voltage

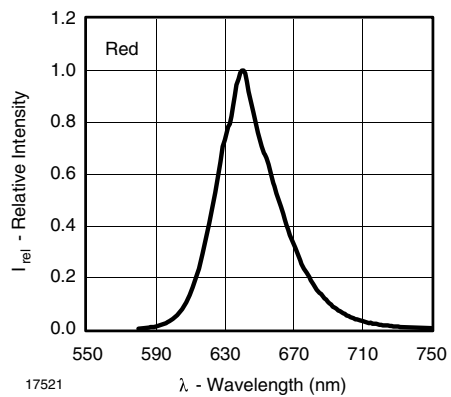

Figure 8. Relative Intensity vs. Wavelength

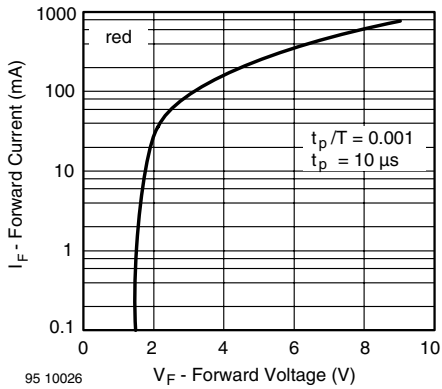

Figure 9. Forward Current vs. Forward Voltage

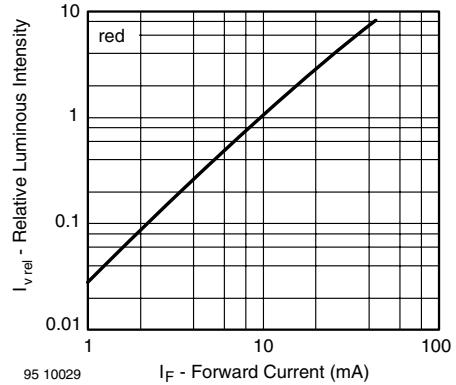

Figure 12. Relative Luminous Intensity vs. Forward Current

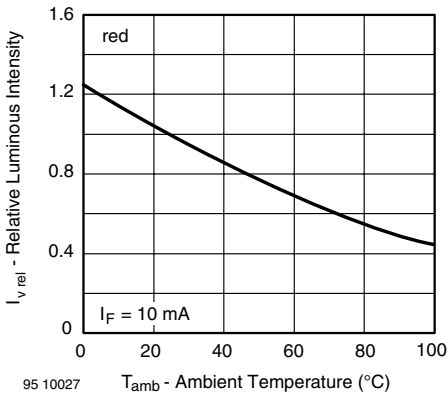

Figure 10. Rel. Luminous Intensity vs. Ambient Temperature

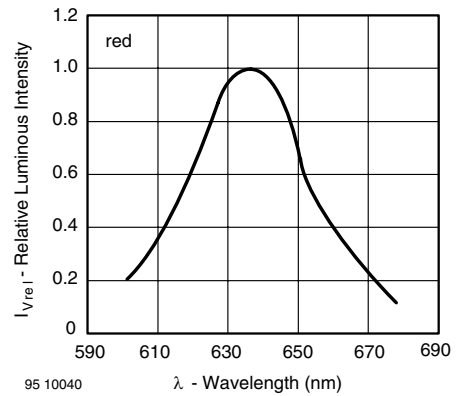

Figure 13. Relative Intensity vs. Wavelength

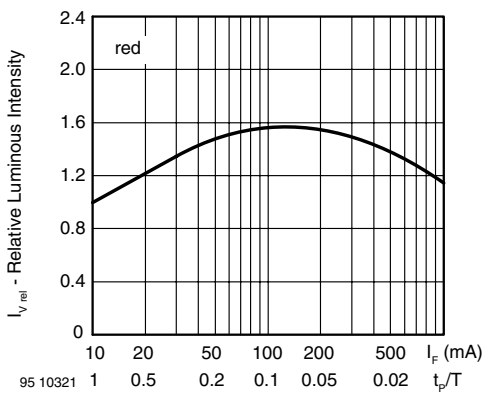

Figure 11. Rel. Lumin. Intensity vs. Forw. Current/Duty Cycle

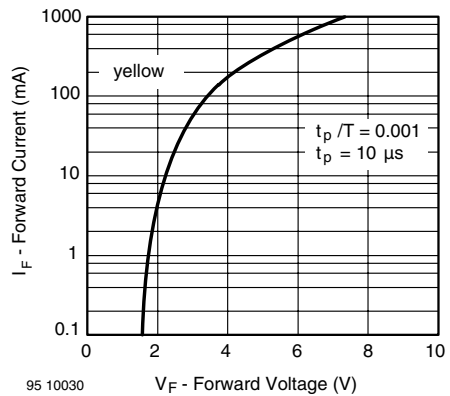

Figure 14. Forward Current vs. Forward Voltage

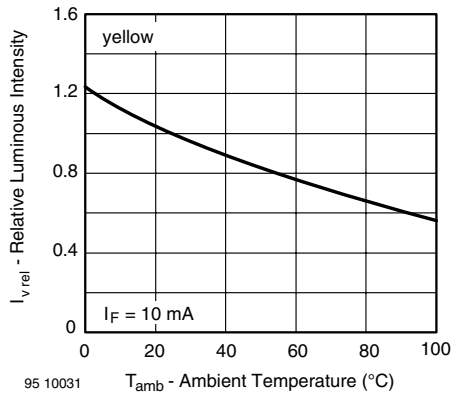

Figure 15. Rel. Luminous Intensity vs. Ambient Temperature

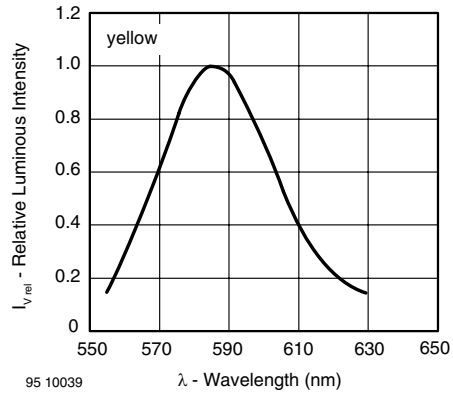

Figure 18. Relative Intensity vs. Wavelength

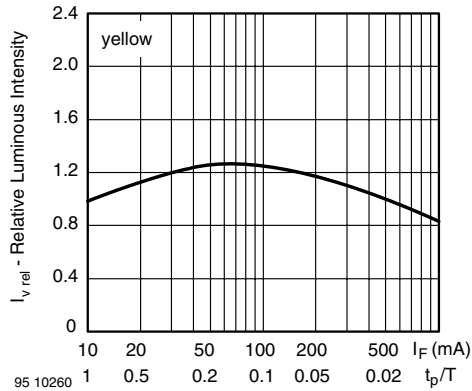

Figure 16. Rel. Lumin. Intensity vs. Forw. Current/Duty Cycle

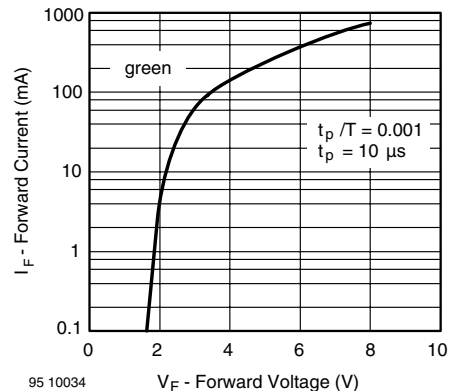

Figure 19. Forward Current vs. Forward Voltage

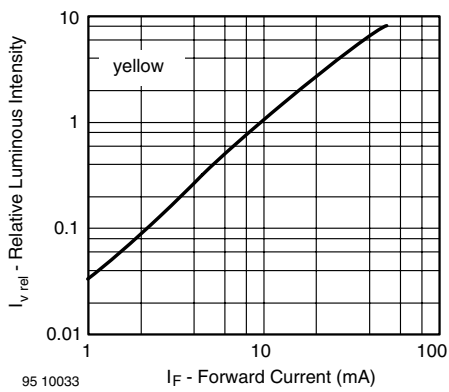

Figure 17. Relative Luminous Intensity vs. Forward Current

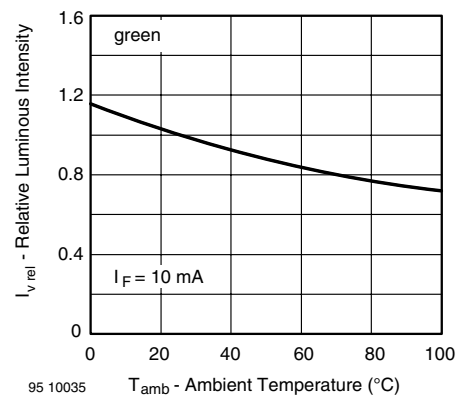

Figure 20. Rel. Luminous Intensity vs. Ambient Temperature

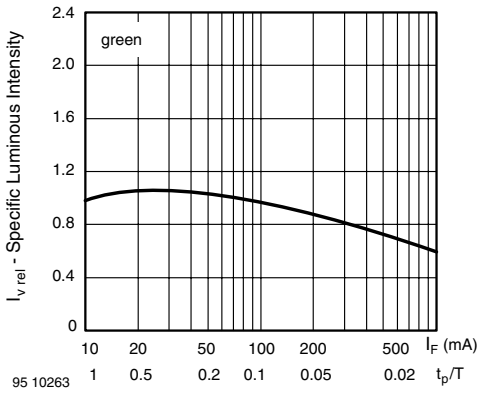

Figure 21. Specific Luminous Intensity vs. Forward Current

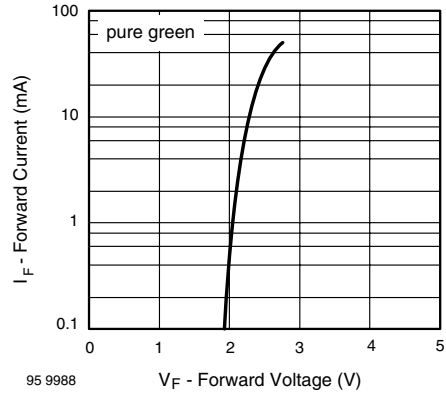

Figure 24. Forward Current vs. Forward Voltage

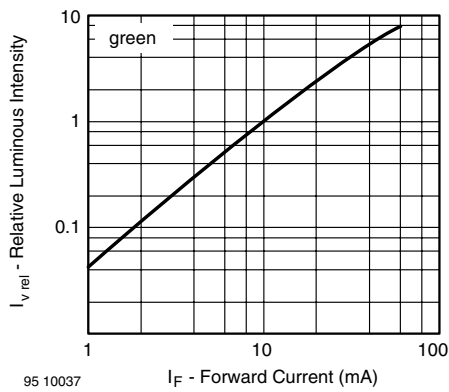

Figure 22. Relative Luminous Intensity vs. Forward Current

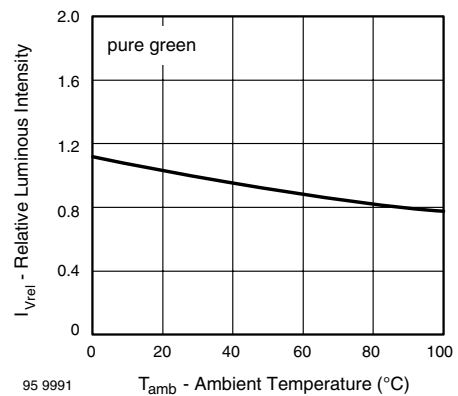

Figure 25. Rel. Luminous Intensity vs. Ambient Temperature

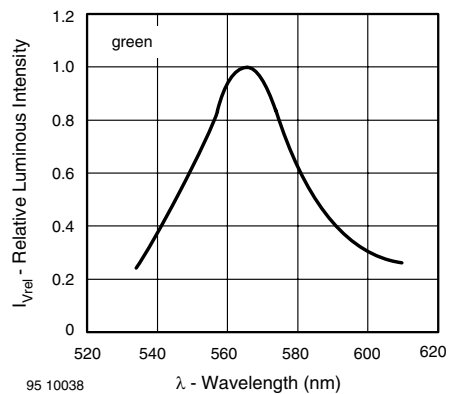

Figure 23. Relative Intensity vs. Wavelength

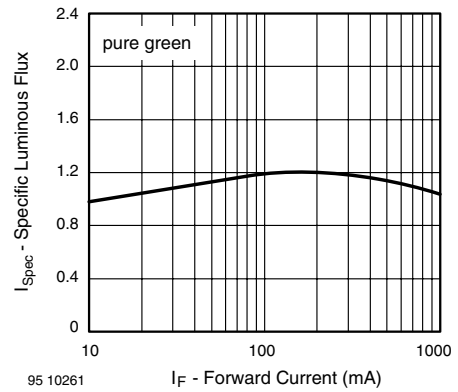

Figure 26. Specific Luminous Intensity vs. Forward Current

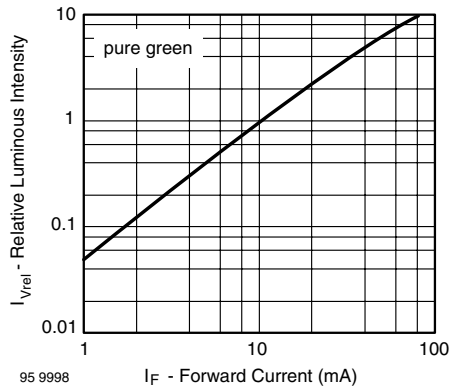

Figure 27. Relative Luminous Intensity vs. Forward Current

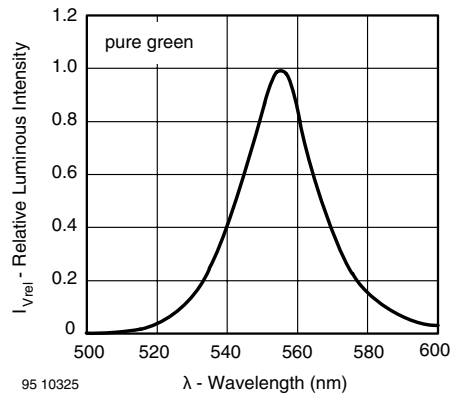
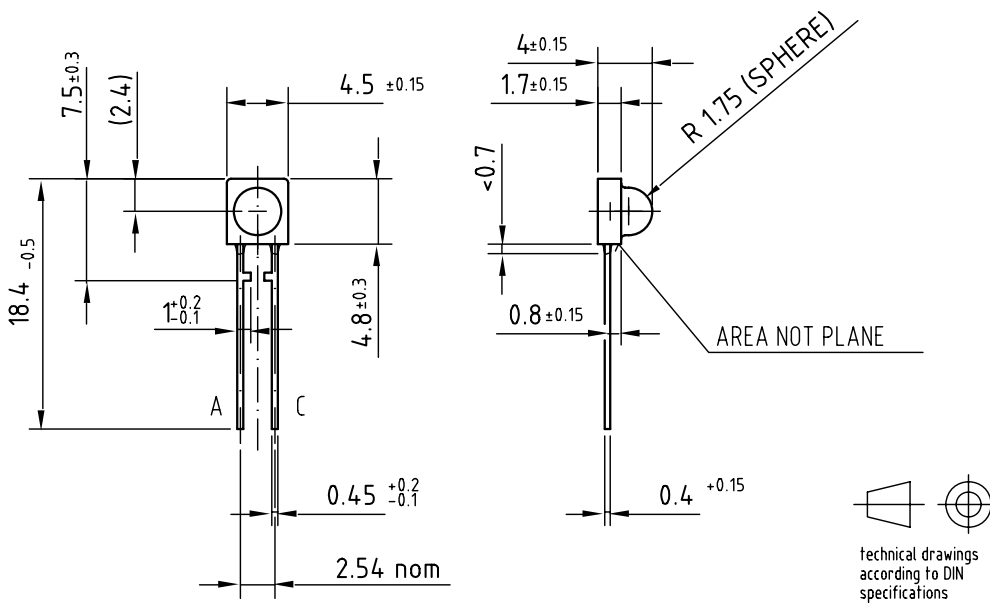

Figure 28. Relative Intensity vs. Wavelength

PACKAGE DIMENSIONS in millimeters



Drawing-No.: 6.544-5127.01-4

Issue: 1; 15.11.95

95 11321



Ozone Depleting Substances Policy Statement

It is the policy of Vishay Semiconductor GmbH to

1. Meet all present and future national and international statutory requirements.
2. Regularly and continuously improve the performance of our products, processes, distribution and operating systems with respect to their impact on the health and safety of our employees and the public, as well as their impact on the environment.

It is particular concern to control or eliminate releases of those substances into the atmosphere which are known as ozone depleting substances (ODSs).

The Montreal Protocol (1987) and its London Amendments (1990) intend to severely restrict the use of ODSs and forbid their use within the next ten years. Various national and international initiatives are pressing for an earlier ban on these substances.

Vishay Semiconductor GmbH has been able to use its policy of continuous improvements to eliminate the use of ODSs listed in the following documents.

1. Annex A, B and list of transitional substances of the Montreal Protocol and the London Amendments respectively
2. Class I and II ozone depleting substances in the Clean Air Act Amendments of 1990 by the Environmental Protection Agency (EPA) in the USA
3. Council Decision 88/540/EEC and 91/690/EEC Annex A, B and C (transitional substances) respectively.

Vishay Semiconductor GmbH can certify that our semiconductors are not manufactured with ozone depleting substances and do not contain such substances.

We reserve the right to make changes to improve technical design
and may do so without further notice.

Parameters can vary in different applications. All operating parameters must be validated for each customer application by the customer. Should the buyer use Vishay Semiconductors products for any unintended or unauthorized application, the buyer shall indemnify Vishay Semiconductors against all claims, costs, damages, and expenses, arising out of, directly or indirectly, any claim of personal damage, injury or death associated with such unintended or unauthorized use.

Vishay Semiconductor GmbH, P.O.B. 3535, D-74025 Heilbronn, Germany



Disclaimer

ALL PRODUCT, PRODUCT SPECIFICATIONS AND DATA ARE SUBJECT TO CHANGE WITHOUT NOTICE TO IMPROVE RELIABILITY, FUNCTION OR DESIGN OR OTHERWISE.

Vishay Intertechnology, Inc., its affiliates, agents, and employees, and all persons acting on its or their behalf (collectively, "Vishay"), disclaim any and all liability for any errors, inaccuracies or incompleteness contained in any datasheet or in any other disclosure relating to any product.

Vishay makes no warranty, representation or guarantee regarding the suitability of the products for any particular purpose or the continuing production of any product. To the maximum extent permitted by applicable law, Vishay disclaims (i) any and all liability arising out of the application or use of any product, (ii) any and all liability, including without limitation special, consequential or incidental damages, and (iii) any and all implied warranties, including warranties of fitness for particular purpose, non-infringement and merchantability.

Statements regarding the suitability of products for certain types of applications are based on Vishay's knowledge of typical requirements that are often placed on Vishay products in generic applications. Such statements are not binding statements about the suitability of products for a particular application. It is the customer's responsibility to validate that a particular product with the properties described in the product specification is suitable for use in a particular application. Parameters provided in datasheets and/or specifications may vary in different applications and performance may vary over time. All operating parameters, including typical parameters, must be validated for each customer application by the customer's technical experts. Product specifications do not expand or otherwise modify Vishay's terms and conditions of purchase, including but not limited to the warranty expressed therein.

Except as expressly indicated in writing, Vishay products are not designed for use in medical, life-saving, or life-sustaining applications or for any other application in which the failure of the Vishay product could result in personal injury or death. Customers using or selling Vishay products not expressly indicated for use in such applications do so at their own risk and agree to fully indemnify and hold Vishay and its distributors harmless from and against any and all claims, liabilities, expenses and damages arising or resulting in connection with such use or sale, including attorneys fees, even if such claim alleges that Vishay or its distributor was negligent regarding the design or manufacture of the part. Please contact authorized Vishay personnel to obtain written terms and conditions regarding products designed for such applications.

No license, express or implied, by estoppel or otherwise, to any intellectual property rights is granted by this document or by any conduct of Vishay. Product names and markings noted herein may be trademarks of their respective owners.