

## Description

The 5PB11xx is a high-performance LVCMOS clock buffer family of devices. It has an additive phase jitter of 50fs RMS.

There are five different fan-out variations available: 1:2 to 1:10.

The 5PB11xx supports a synchronous glitch-free output enable (OE) function to eliminate any potential intermediate incorrect output clock cycles when enabling or disabling outputs. It can operate from a 1.8V to 3.3V supply.

The 5PB1104 is also available in an Automotive Grade 1, AEC-Q100 qualified version.

## Typical Applications

- Industrial applications
- Automotive applications

## Features

- High-performance 1:2, 1:4, 1:6, 1:8, 1:10 LVCMOS clock buffer
- Very low pin-to-pin skew: < 50ps
- Very low additive jitter: < 50fs
- Supply voltage: 1.8V to 3.3V
- 3.3V tolerant input clock
- $f_{MAX} = 200\text{MHz}$
- Integrated serial termination for 50Ω channel
- Packaged in 8-, 14-, 16-, 20-pin TSSOP and as small as 2 × 2 mm DFN and VFQFPN packages
- Industrial (-40°C to +85°C) and extended (-40°C to +105°C) temperature ranges
- 5PB1104 available in AEC-Q100 qualified, Automotive Grade 1 (-40°C to +125°C)

## Block Diagram

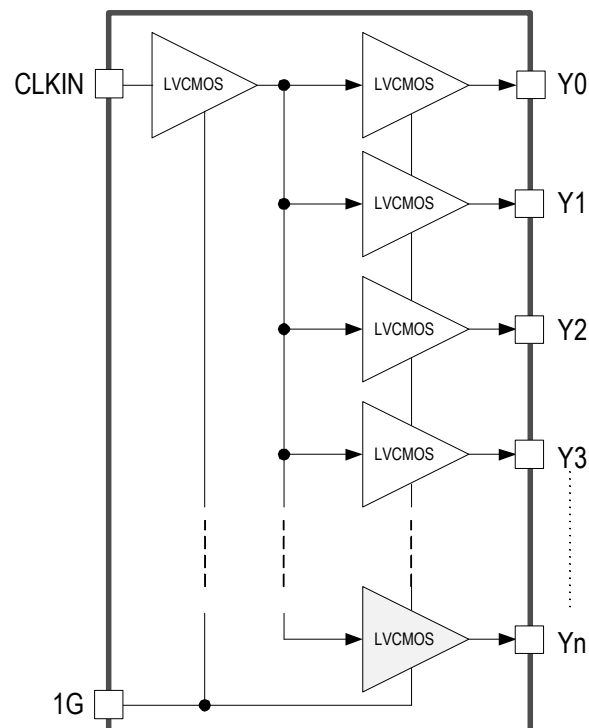

# Contents

|  |    |
|--|----|
| Description .....                          | 1  |
| Typical Applications .....                 | 1  |
| Features .....                             | 1  |
| Block Diagram .....                        | 1  |
| Pin Assignments–TSSOP Packages .....       | 3  |
| Pin Descriptions–TSSOP Packages .....      | 3  |
| Pin Assignments–DFN/VFQFPN Packages .....  | 4  |
| Pin Descriptions–DFN/VFQFPN Packages ..... | 4  |
| Output Logic Table .....                   | 5  |
| Absolute Maximum Ratings .....             | 5  |
| Recommended Operating Conditions .....     | 5  |
| Thermal Characteristics .....              | 6  |
| DC Electrical Characteristics .....        | 7  |
| AC Electrical Characteristics .....        | 10 |
| Phase Noise Plots .....                    | 13 |
| Test Load and Circuit .....                | 14 |
| Package Outline Drawings .....             | 14 |
| Marking Diagrams (Industrial) .....        | 15 |
| Marking Diagrams (Extended) .....          | 16 |
| Marking Diagrams (Automotive) .....        | 16 |
| Ordering Information (Industrial) .....    | 17 |
| Ordering Information (Extended) .....      | 18 |
| Ordering Information (Automotive) .....    | 18 |
| Revision History .....                     | 19 |

## Pin Assignments–TSSOP Packages

Figure 1. Pin Assignments for TSSOP Packages

|       |   |   |     |       |   |    |     |       |    |    |     |
|-------|---|---|-----|-------|---|----|-----|-------|----|----|-----|
| CLKIN | 1 | 8 | Y1  | CLKIN | 1 | 14 | Y1  | CLKIN | 1  | 20 | Y1  |
| 1G    | 2 | 7 | NC  | 1G    | 2 | 13 | Y3  | 1G    | 2  | 19 | Y3  |
| Y0    | 3 | 6 | VDD | Y0    | 3 | 12 | VDD | Y0    | 3  | 18 | VDD |
| GND   | 4 | 5 | NC  | GND   | 4 | 11 | Y2  | GND   | 4  | 17 | Y2  |
|       |   |   |     | VDD   | 5 | 10 | GND | VDD   | 5  | 16 | GND |
|       |   |   |     | Y4    | 6 | 9  | Y5  | Y4    | 6  | 15 | Y5  |
|       |   |   |     | GND   | 7 | 8  | VDD | GND   | 7  | 14 | VDD |
|       |   |   |     |       |   |    |     | Y6    | 8  | 13 | Y7  |
|       |   |   |     |       |   |    |     | VDD   | 9  | 12 | Y8  |
|       |   |   |     |       |   |    |     | Y9    | 10 | 11 | GND |
|       |   |   |     |       |   |    |     |       |    |    |     |
| CLKIN | 1 | 8 | Y1  | CLKIN | 1 | 16 | Y1  |       |    |    |     |
| 1G    | 2 | 7 | Y3  | 1G    | 2 | 15 | Y3  |       |    |    |     |
| Y0    | 3 | 6 | VDD | Y0    | 3 | 14 | VDD |       |    |    |     |
| GND   | 4 | 5 | Y2  | GND   | 4 | 13 | Y2  |       |    |    |     |
|       |   |   |     | VDD   | 5 | 12 | GND |       |    |    |     |
|       |   |   |     | Y4    | 6 | 11 | Y5  |       |    |    |     |
|       |   |   |     | GND   | 7 | 10 | VDD |       |    |    |     |
|       |   |   |     | Y6    | 8 | 9  | Y7  |       |    |    |     |

## Pin Descriptions–TSSOP Packages

Table 1. Pin Descriptions for TSSOP Packages

| Device Number | LVC MOS<br>Clock Input | Clock Output<br>Enable | LVC MOS Clock Output                | Supply Voltage  | Ground       |
|---------------|------------------------|------------------------|-------------------------------------|-----------------|--------------|
|               | CLKIN                  | 1G                     | Y0, Y1, . . . Y9                    | V <sub>DD</sub> | GND          |
| 5PB1102PGG    | 1                      | 2                      | 3, 8                                | 6               | 4            |
| 5PB1104PGG    | 1                      | 2                      | 3, 8, 5, 7                          | 6               | 4            |
| 5PB1106PGG    | 1                      | 2                      | 3, 14, 11, 13, 6, 9                 | 5, 8, 12        | 4, 7, 10     |
| 5PB1108PGG    | 1                      | 2                      | 3, 16, 13, 15, 6, 11, 8, 9          | 5, 10, 14       | 4, 7, 12     |
| 5PB1110PGG    | 1                      | 2                      | 3, 20, 17, 19, 6, 15, 8, 13, 12, 10 | 6               | 4, 7, 11, 16 |

## Pin Assignments–DFN/VFQFPN Packages

Figure 2. Pin Assignments for DFN/QFN Packages

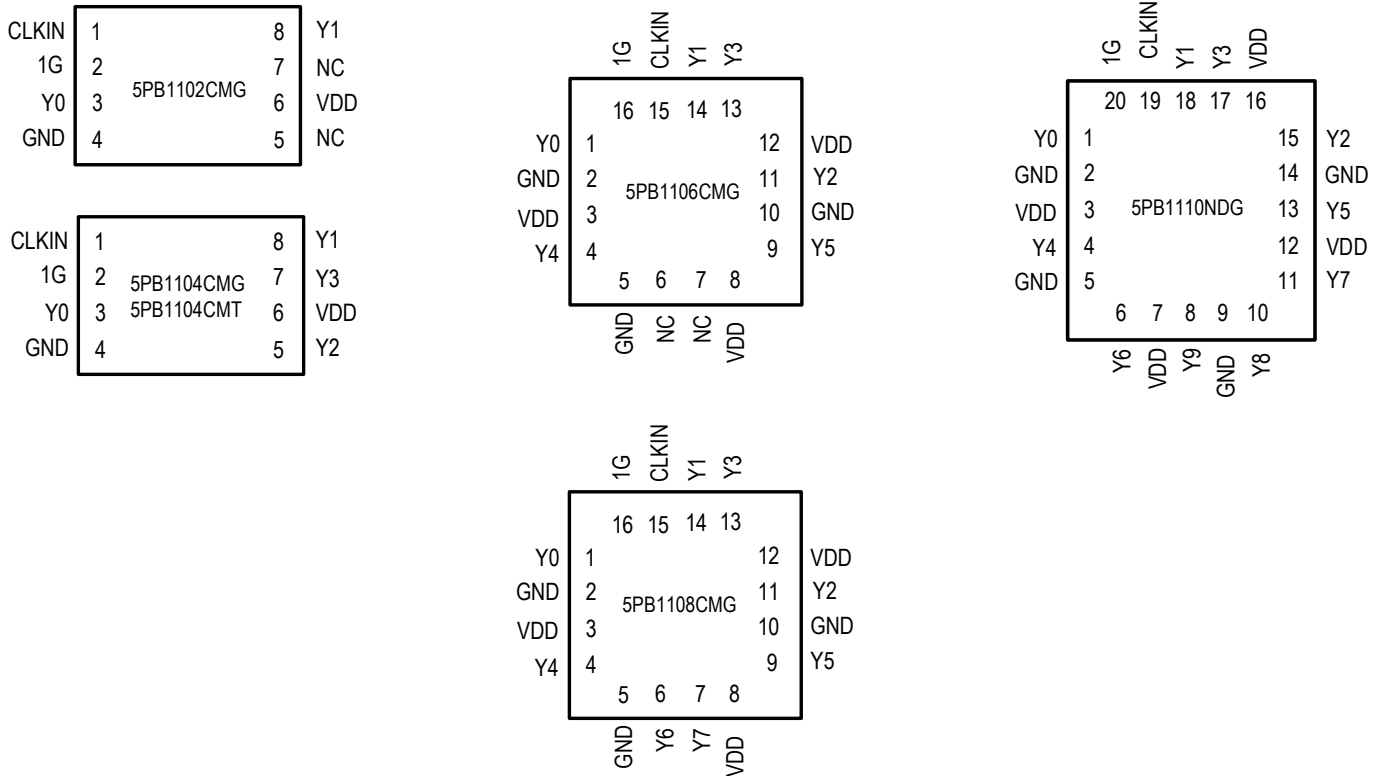

## Pin Descriptions–DFN/VFQFPN Packages

Table 2. Pin Descriptions for DFN/VFQFPN Packages

| Device Number            | LVC MOS Clock Input | Clock Output Enable | LVC MOS Clock Output               | Supply Voltage  | Ground      |
|--------------------------|---------------------|---------------------|------------------------------------|-----------------|-------------|
|                          | CLKIN               | 1G                  | Y0, Y1, . . . Y9                   | V <sub>DD</sub> | GND         |
| 5PB1102CMG               | 1                   | 2                   | 3, 8                               | 6               | 4           |
| 5PB1104CMG<br>5PB1104CMT | 1                   | 2                   | 3, 5, 7, 8                         | 6               | 4           |
| 5PB1106CMG               | 15                  | 16                  | 1, 4, 9, 11, 13, 14                | 3, 8, 12        | 2, 5, 10    |
| 5PB1108CMG               | 15                  | 16                  | 1, 4, 6, 7, 9, 11, 13, 14          | 3, 8, 12        | 2, 5, 10    |
| 5PB1110NDG               | 19                  | 20                  | 1, 4, 6, 8, 10, 11, 13, 15, 17, 18 | 3, 7, 12, 16    | 2, 5, 9, 14 |

## Output Logic Table

| Inputs |    | Output |
|--------|----|--------|
| CLKIN  | 1G | Yn     |
| X      | L  | L      |
| L      | H  | L      |
| H      | H  | H      |

After at least three cycles of input clock toggling. Output Enable function is asynchronous to eliminate any intermediate incorrect output clock cycles during transition which may cause frequency peaking to the downstream device.

## Absolute Maximum Ratings

The absolute maximum ratings are stress ratings only. Stresses greater than those listed below can cause permanent damage to the device. Functional operation of the 5PB11xx at absolute maximum ratings is not implied. Exposure to absolute maximum rating conditions may affect device reliability.

Table 3. Absolute Maximum Ratings

| Item   | Rating                     |
|--|----------------------------|
| Supply Voltage, $V_{DD}$                           | 3.8V                       |
| Output Enable and All Outputs                      | -0.4 V to $V_{DD} + 0.5$ V |
| Input Voltage, CLKIN                               | -0.4 V to 3.465V           |
| Ambient Operating Temperature (Industrial)         | -40 to +85°C               |
| Ambient Operating Temperature (Extended)           | -40 to +105°C              |
| Ambient Operating Temperature (Automotive Grade 1) | -40 to +125°C              |
| Storage Temperature                                | -65 to +150°C              |
| Junction Temperature                               | 125°C                      |
| Soldering Temperature                              | 260°C                      |

## Recommended Operating Conditions

Table 4. Recommended Operating Conditions

| Parameter  | Minimum | Typical | Maximum | Units |
|--|---------|---------|---------|-------|
| Ambient Operating Temperature (Industrial)         | -40     |         | +85     |       |
| Ambient Operating Temperature (Extended)           | -40     |         | +105    |       |
| Ambient Operating Temperature (Automotive Grade 1) | -40     |         | +125    | °C    |
| Power Supply Voltage (measured in respect to GND)  | +1.71   |         | +3.465  | V     |

## Thermal Characteristics

Table 5. Thermal Characteristics

| Package   | Applies to                           | $\theta_{JA}$ | $\theta_{JC}$ | $\theta_{JB}$ | Units           |
|-----------|--------------------------------------|---------------|---------------|---------------|-----------------|
| 8-TSSOP   | 5PB1102PGG, 5PB1104PGG               | 122.0         | 58.2          | 139.3         | °C/W; still air |
| 14-TSSOP  | 5PB1106PGG                           | 84.5          | 44.2          | 64.5          | °C/W; still air |
| 16-TSSOP  | 5PB1108PGG                           | 80.9          | 43.3          | 60.1          | °C/W; still air |
| 20-TSSOP  | 5PB1110PGG                           | 72.5          | 37.9          | 49.8          | °C/W; still air |
| 8-DFN     | 5PB1102CMG, 5PB1104CMG<br>5PB1104CMT | 120.2         | 99.4          | 63.3          | °C/W; still air |
| 16-VFQFPN | 5PB1106CMG, 5PB1108CMG               | 115.6         | 83.1          | 61.8          | °C/W; still air |
| 20-VFQFPN | 5PB1110NDG                           | 49.6          | 94.7          | 5.1           | °C/W; still air |

## DC Electrical Characteristics

$V_{DD} = 1.8V, 2.5V, \text{ or } 3.3V$  (see tables below)

Table 6. DC Electrical Characteristics –  $V_{DD} = 1.8V \pm 5\%$

| Symbol   | Parameter                                | Applies to                             | Conditions              | Minimum             | Typical | Maximum             | Units    |
|----------|--|--|-------------------------|---------------------|---------|---------------------|----------|
| $V_{DD}$ | Operating Voltage                        | All devices                            |                         | 1.71                | 1.8     | 1.89                | V        |
| $V_{IH}$ | Input High Voltage, CLKIN <sup>[1]</sup> | All devices                            |                         | $0.7 \times V_{DD}$ |         |                     | V        |
| $V_{IL}$ | Input Low Voltage, CLKIN <sup>[1]</sup>  | All devices                            |                         |                     |         | $0.3 \times V_{DD}$ | V        |
| $V_{IH}$ | Input High Voltage, 1G                   | All devices                            |                         | 1.6                 |         | $V_{DD}$            | V        |
| $V_{IL}$ | Input Low Voltage, 1G                    | All devices                            |                         |                     |         | 0.6                 | V        |
| $V_{OH}$ | Output High Voltage                      | Industrial and Extended <sup>[2]</sup> | $I_{OH} = -5mA.$        | 1.4                 |         |                     | V        |
|          | Output High Voltage                      | Automotive <sup>[3]</sup>              | $I_{OH} = -5mA.$        | 1.2                 |         |                     | V        |
| $V_{OL}$ | Output Low Voltage                       | Industrial and Extended <sup>[2]</sup> | $I_{OL} = 5mA.$         |                     |         | 0.4                 | V        |
|          | Output Low Voltage                       | Automotive <sup>[3]</sup>              | $I_{OL} = 5mA.$         |                     |         | 0.45                | V        |
| $Z_O$    | Nominal Output Impedance                 | All devices                            |                         |                     | 50      |                     | $\Omega$ |
| $C_{IN}$ | Input Capacitance                        | All devices                            | CLKIN, 1G pin.          |                     | 5       |                     | pF       |
| $I_{DD}$ | Operating Supply Current, 5PB1102        | Industrial and Extended <sup>[2]</sup> | 100MHz, no load, 25°C.  |                     | 6       | 8                   | mA       |
|          | Operating Supply Current, 5PB1104        |  |                         |                     | 12      | 13                  |          |
|          | Operating Supply Current, 5PB1106        |  |                         |                     | 15      | 18                  |          |
|          | Operating Supply Current, 5PB1108        |  |                         |                     | 20      | 23                  |          |
|          | Operating Supply Current, 5PB1110        |  |                         |                     | 23      | 27                  |          |
| $I_{DD}$ | Operating Supply Current                 | Automotive <sup>[3]</sup>              | 0.001MHz, $C_L = 5pF.$  |                     | 0.7     | 1                   | mA       |
|          |  |  | 0.008MHz, $C_L = 5pF.$  |                     | 0.7     | 1                   |          |
|          |  |  | 40MHz, $C_L = 5pF.$     |                     | 11      | 13                  |          |
|          |  |  | 100MHz, $C_L = 5pF.$    |                     | 25      | 30                  |          |
|          |  |  | 156.25MHz, $C_L = 5pF.$ |                     | 37      | 47                  |          |
|          |  |  | 200MHz, $C_L = 5pF.$    |                     | 39      | 57                  |          |

<sup>[1]</sup> Nominal switching threshold is  $V_{DD}/2$ .

<sup>[2]</sup> 5PB11xxPGGI, 5PB11xxPGGK, 5PB11xxCMGI, 5PB11xxCMGK.  $T_A = -40^\circ C$  to  $+105^\circ C$  unless stated otherwise.

<sup>[3]</sup> 5PB1104CMG1 and 5PB1104CMT1 only.  $T_A = -40^\circ C$  to  $+125^\circ C$  unless stated otherwise.

Table 7. DC Electrical Characteristics –  $V_{DD} = 2.5V \pm 5\%$ 

| Symbol   | Parameter                                | Applies to                             | Conditions               | Minimum             | Typical | Maximum             | Units    |
|----------|--|--|--------------------------|---------------------|---------|---------------------|----------|
| $V_{DD}$ | Operating Voltage                        | All devices                            |                          | 2.375               | 2.5     | 2.625               | V        |
| $V_{IH}$ | Input High Voltage, CLKIN <sup>[1]</sup> | All devices                            |                          | $0.7 \times V_{DD}$ |         |                     | V        |
| $V_{IL}$ | Input Low Voltage, CLKIN <sup>[1]</sup>  | All devices                            |                          |                     |         | $0.3 \times V_{DD}$ | V        |
| $V_{IH}$ | Input High Voltage, 1G                   | All devices                            |                          | 1.8                 |         | $V_{DD}$            | V        |
| $V_{IL}$ | Input Low Voltage, 1G                    | All devices                            |                          |                     |         | 0.7                 | V        |
| $V_{OH}$ | Output High Voltage                      | Industrial and Extended <sup>[2]</sup> | $I_{OH} = -8mA$ .        | 1.9                 |         |                     | V        |
|          | Output High Voltage                      | Automotive <sup>[3]</sup>              | $I_{OH} = -8mA$ .        | 1.6                 |         |                     | V        |
| $V_{OL}$ | Output Low Voltage                       | Industrial and Extended <sup>[2]</sup> | $I_{OL} = 8mA$ .         |                     |         | 0.5                 | V        |
|          | Output Low Voltage                       | Automotive <sup>[3]</sup>              | $I_{OL} = 8mA$ .         |                     |         | 0.625               | V        |
| $Z_O$    | Nominal Output Impedance                 | All devices                            |                          |                     | 50      |                     | $\Omega$ |
| $C_{IN}$ | Input Capacitance                        | All devices                            | CLKIN, 1G pin.           |                     | 5       |                     | pF       |
| $I_{DD}$ | Operating Supply Current, 5PB1102        | Industrial and Extended <sup>[2]</sup> | 100MHz, no load, 25°C.   |                     | 9       | 11                  | mA       |
|          | Operating Supply Current, 5PB1104        |  |                          |                     | 15      | 18                  |          |
|          | Operating Supply Current, 5PB1106        |  |                          |                     | 21      | 24                  |          |
|          | Operating Supply Current, 5PB1108        |  |                          |                     | 27      | 31                  |          |
|          | Operating Supply Current, 5PB1110        |  |                          |                     | 32      | 37                  |          |
| $I_{DD}$ | Operating Supply Current                 | Automotive <sup>[3]</sup>              | 0.001MHz, $C_L = 5pF$ .  |                     | 0.9     | 1.3                 | mA       |
|          |  |  | 0.008MHz, $C_L = 5pF$ .  |                     | 0.9     | 1.3                 |          |
|          |  |  | 40MHz, $C_L = 5pF$ .     |                     | 15      | 17                  |          |
|          |  |  | 100MHz, $C_L = 5pF$ .    |                     | 35      | 42                  |          |
|          |  |  | 156.25MHz, $C_L = 5pF$ . |                     | 52      | 67                  |          |
|          |  |  | 200MHz, $C_L = 5pF$ .    |                     | 56      | 80                  |          |

<sup>[1]</sup> Nominal switching threshold is  $V_{DD}/2$ .

<sup>[2]</sup> 5PB11xxPGGI, 5PB11xxPGGK, 5PB11xxCMGI, 5PB11xxCMGK.  $T_A = -40^\circ C$  to  $+105^\circ C$  unless stated otherwise.

<sup>[3]</sup> 5PB1104CMG1 and 5PB1104CMT1 only.  $T_A = -40^\circ C$  to  $+125^\circ C$  unless stated otherwise.



Table 8. DC Electrical Characteristics –  $V_{DD} = 3.3V \pm 5\%$ 

| Symbol   | Parameter                                | Applies to                             | Conditions               | Minimum             | Typical | Maximum             | Units    |
|----------|--|--|--------------------------|---------------------|---------|---------------------|----------|
| $V_{DD}$ | Operating Voltage                        | All devices                            |                          | 3.135               | 3.3     | 3.465               | V        |
| $V_{IH}$ | Input High Voltage, CLKIN <sup>[1]</sup> | All devices                            |                          | $0.7 \times V_{DD}$ |         |                     | V        |
| $V_{IL}$ | Input Low Voltage, CLKIN <sup>[1]</sup>  | All devices                            |                          |                     |         | $0.3 \times V_{DD}$ | V        |
| $V_{IH}$ | Input High Voltage, 1G                   | Industrial and Extended <sup>[2]</sup> |                          | 2.0                 |         | $V_{DD}$            | V        |
| $V_{IH}$ | Input High Voltage, 1G                   | Automotive <sup>[3]</sup>              |                          | 2.1                 |         | $V_{DD}$            | V        |
| $V_{IL}$ | Input Low Voltage, 1G                    | All devices                            |                          |                     |         | 0.8                 | V        |
| $V_{OH}$ | Output High Voltage                      | Industrial and Extended <sup>[2]</sup> | $I_{OH} = -12mA$ .       | 2.4                 |         |                     | V        |
|          | Output High Voltage                      | Automotive <sup>[3]</sup>              | $I_{OH} = -12mA$ .       | 2.1                 |         |                     | V        |
| $V_{OL}$ | Output Low Voltage                       | Industrial and Extended <sup>[2]</sup> | $I_{OL} = 12mA$ .        |                     |         | 0.7                 | V        |
|          | Output Low Voltage                       | Automotive <sup>[3]</sup>              | $I_{OL} = 12mA$ .        |                     |         | 0.825               | V        |
| $Z_O$    | Nominal Output Impedance                 | All devices                            |                          |                     | 50      |                     | $\Omega$ |
| $C_{IN}$ | Input Capacitance                        | All devices                            | CLKIN, 1G pin.           |                     | 5       |                     | pF       |
| $I_{DD}$ | Operating Supply Current, 5PB1102        | Industrial and Extended <sup>[2]</sup> | 100MHz, no load, 25°C.   |                     | 12      | 13                  | mA       |
|          | Operating Supply Current, 5PB1104        |  |                          |                     | 20      | 22                  |          |
|          | Operating Supply Current, 5PB1106        |  |                          |                     | 25      | 30                  |          |
|          | Operating Supply Current, 5PB1108        |  |                          |                     | 35      | 38                  |          |
|          | Operating Supply Current, 5PB1110        |  |                          |                     | 40      | 45                  |          |
| $I_{DD}$ | Operating Supply Current                 | Automotive <sup>[3]</sup>              | 0.001MHz, $C_L = 5pF$ .  |                     | 1.2     | 1.7                 | mA       |
|          |  |  | 0.008MHz, $C_L = 5pF$ .  |                     | 1.2     | 1.7                 |          |
|          |  |  | 40MHz, $C_L = 5pF$ .     |                     | 19      | 22                  |          |
|          |  |  | 100MHz, $C_L = 5pF$ .    |                     | 45      | 54                  |          |
|          |  |  | 156.25MHz, $C_L = 5pF$ . |                     | 67      | 87                  |          |
|          |  |  | 200MHz, $C_L = 5pF$ .    |                     | 75      | 107                 |          |

<sup>[1]</sup> Nominal switching threshold is  $V_{DD}/2$ .

<sup>[2]</sup> 5PB11xxPGGI, 5PB11xxPGGK, 5PB11xxCMGI, 5PB11xxCMGK.  $T_A = -40^\circ C$  to  $+105^\circ C$  unless stated otherwise.

<sup>[3]</sup> 5PB1104CMG1 and 5PB1104CMT1 only.  $T_A = -40^\circ C$  to  $+125^\circ C$  unless stated otherwise.

## AC Electrical Characteristics

$V_{DD} = 1.8V, 2.5V, \text{ or } 3.3V$  (see tables below).

Table 9. AC Electrical Characteristics –  $V_{DD} = 1.8V \pm 5\%$

| Symbol         | Parameter                         | Applies to                             | Conditions   | Minimum | Typical | Maximum | Units  |
|----------------|-----------------------------------|--|--|---------|---------|---------|--------|
|                | Input Frequency                   | All devices                            |  | 0       |         | 200     | MHz    |
| $t_{OR}$       | Output Rise Time (2pF load)       | Industrial and Extended <sup>[1]</sup> | 0.36V to 1.44V, $C_L = 2pF$ .                                |         | 0.5     | 0.75    | ns     |
| $t_{OF}$       | Output Fall Time (2pF load)       | Industrial and Extended <sup>[1]</sup> | 1.44V to 0.36V, $C_L = 2pF$ .                                |         | 0.5     | 0.75    | ns     |
| $t_{OR}$       | Output Rise Time (5pF load)       | Industrial and Extended <sup>[1]</sup> | 0.36V to 1.44V, $C_L = 5pF$ .                                |         | 0.8     | 1.0     | ns     |
| $t_{OF}$       | Output Fall Time (5pF load)       | Industrial and Extended <sup>[1]</sup> | 1.44V to 0.36V, $C_L = 5pF$ .                                |         | 0.8     | 1.0     | ns     |
| $t_{OR}$       | Output Rise Time (5pF load)       | Automotive <sup>[2]</sup>              | 0.36V to 1.44V, $C_L = 5pF$ .                                |         | 0.65    | 1.2     | ns     |
| $t_{OF}$       | Output Fall Time (5pF load)       | Automotive <sup>[2]</sup>              | 1.44V to 0.36V, $C_L = 5pF$ .                                |         | 0.65    | 1.2     | ns     |
| $t_{START-UP}$ | Start-up Time                     | All devices                            | Part start-up time for valid outputs after $V_{DD}$ ramp-up. |         |         | 3       | ms     |
| $t_{PD}$       | Propagation Delay <sup>[3]</sup>  | Industrial and Extended <sup>[1]</sup> |  | 1.5     |         | 2.5     | ns     |
|                |                                   | Automotive <sup>[2]</sup>              |  | 1.0     |         | 3.4     | ns     |
|                | Buffer Additive Phase Jitter, RMS | Industrial and Extended <sup>[1]</sup> | 156.25MHz, Integration Range: 12kHz–20MHz.                   |         |         | 0.05    | ps     |
|                |                                   | Automotive <sup>[2]</sup>              | 156.25MHz, Integration Range: 12kHz–20MHz.                   |         |         | 0.06    | ps     |
|                | Output to Output Skew, 5PB1102/04 | Industrial and Extended <sup>[1]</sup> | Rising edges at $V_{DD}/2$ . <sup>[4]</sup>                  |         | 35      | 50      | ps     |
|                | Output to Output Skew, 5PB1106    | Industrial and Extended <sup>[1]</sup> | Rising edges at $V_{DD}/2$ . <sup>[4]</sup>                  |         | 35      | 58      | ps     |
|                | Output to Output Skew, 5PB1108/10 | Industrial and Extended <sup>[1]</sup> | Rising edges at $V_{DD}/2$ . <sup>[4]</sup>                  |         | 45      | 65      | ps     |
|                | Output to Output Skew             | Automotive <sup>[2]</sup>              | Rising edges at $V_{DD}/2$ . <sup>[4]</sup>                  |         | 35      | 87      | ps     |
|                | Device to Device Skew             | All devices                            | Rising edges at $V_{DD}/2$ .                                 |         |         | 200     | ps     |
| $t_{EN}$       | Output Enable Time                | All devices                            | $C_L \leq 5pF$ .   |         |         | 3       | cycles |
| $t_{DIS}$      | Output Disable Time               | All devices                            | $C_L \leq 5pF$ .   |         |         | 3       | cycles |
| $t_{DC}$       | Duty Cycle <sup>[5]</sup>         | All devices                            |  |         | 50      |         | %      |

<sup>1</sup> 5PB11xxPGGI, 5PB11xxPGGK, 5PB11xxCMGI, 5PB11xxCMGK.  $T_A = -40^\circ C$  to  $+105^\circ C$  unless stated otherwise.

<sup>2</sup> 5PB1104CMG1 and 5PB1104CMT1 only.  $T_A = -40^\circ C$  to  $+125^\circ C$  unless stated otherwise.

<sup>3</sup> With rail-to-rail input clock.

<sup>4</sup> Between any 2 outputs with equal loading.

<sup>5</sup> Duty cycle on outputs will match incoming clock duty cycle when  $V_{IH}$  on CLKIN pin equals  $V_{DD}$  power supply voltage. Consult IDT for tight duty cycle clock generators.

Table 10. AC Electrical Characteristics –  $V_{DD} = 2.5V \pm 5\%$ 

| Symbol         | Parameter                                    | Applies to                             | Conditions   | Minimum | Typical | Maximum | Units  |
|----------------|--|--|--|---------|---------|---------|--------|
|                | Input Frequency                              | All devices                            |  | 0       |         | 200     | MHz    |
| $t_{OR}$       | Output Rise Time (2pF load)                  | Industrial and Extended <sup>[1]</sup> | 0.5V to 2.0V, $C_L = 2pF$ .                                  |         | 0.4     | 0.7     | ns     |
| $t_{OF}$       | Output Fall Time (2pF load)                  | Industrial and Extended <sup>[1]</sup> | 2.0V to 0.5V, $C_L = 2pF$ .                                  |         | 0.4     | 0.7     | ns     |
| $t_{OR}$       | Output Rise Time (5pF load)                  | Industrial and Extended <sup>[1]</sup> | 0.5V to 2.0V, $C_L = 5pF$ .                                  |         | 0.75    | 1.0     | ns     |
| $t_{OF}$       | Output Fall Time (5pF load)                  | Industrial and Extended <sup>[1]</sup> | 2.0V to 0.5V, $C_L = 5pF$ .                                  |         | 0.75    | 1.0     | ns     |
| $t_{OR}$       | Output Rise Time (5pF load)                  | Automotive <sup>[2]</sup>              | 0.5V to 2.0V, $C_L = 5pF$ .                                  |         | 0.63    | 1.2     | ns     |
| $t_{OF}$       | Output Fall Time (5pF load)                  | Automotive <sup>[2]</sup>              | 2.0V to 0.5V, $C_L = 5pF$ .                                  |         | 0.63    | 1.2     | ns     |
| $t_{START-UP}$ | Start-up Time                                | All devices                            | Part start-up time for valid outputs after $V_{DD}$ ramp-up. |         |         | 3       | ms     |
| $t_{PD}$       | Propagation Delay, 5PB1102/04 <sup>[3]</sup> | Industrial and Extended <sup>[1]</sup> |  | 1.9     |         | 2.9     | ns     |
|                | Propagation Delay, 5PB1106/08 <sup>[3]</sup> | Industrial and Extended <sup>[1]</sup> |  | 2.0     |         | 3.3     | ns     |
|                | Propagation Delay, 5PB1110 <sup>[3]</sup>    | Industrial and Extended <sup>[1]</sup> |  | 2.0     |         | 3.0     | ns     |
|                | Propagation Delay <sup>[3]</sup>             | Automotive <sup>[2]</sup>              |  | 1.0     |         | 4.5     | ns     |
|                | Buffer Additive Phase Jitter, RMS            | Industrial and Extended <sup>[1]</sup> | 156.25MHz, Integration Range: 12kHz–20MHz.                   |         |         | 0.05    | ps     |
|                |  | Automotive <sup>[2]</sup>              | 156.25MHz, Integration Range: 12kHz–20MHz.                   |         |         | 0.06    | ps     |
|                | Output to Output Skew, 5PB1102/04            | Industrial and Extended <sup>[1]</sup> | Rising edges at $V_{DD}/2$ . <sup>[4]</sup>                  |         | 35      | 50      | ps     |
|                | Output to Output Skew, 5PB1106               | Industrial and Extended <sup>[1]</sup> | Rising edges at $V_{DD}/2$ . <sup>[4]</sup>                  |         | 35      | 58      | ps     |
|                | Output to Output Skew, 5PB1108/10            | Industrial and Extended <sup>[1]</sup> | Rising edges at $V_{DD}/2$ . <sup>[4]</sup>                  |         | 45      | 65      | ps     |
|                | Output to Output Skew                        | Automotive <sup>[2]</sup>              | Rising edges at $V_{DD}/2$ . <sup>[4]</sup>                  |         | 35      | 87      | ps     |
|                | Device to Device Skew                        | All devices                            | Rising edges at $V_{DD}/2$ .                                 |         |         | 200     | ps     |
| $t_{EN}$       | Output Enable Time                           | All devices                            | $C_L \leq 5pF$ .   |         |         | 3       | cycles |
| $t_{DIS}$      | Output Disable Time                          | All devices                            | $C_L \leq 5pF$ .   |         |         | 3       | cycles |
| $t_{DC}$       | Duty Cycle <sup>[5]</sup>                    | All devices                            |  |         | 50      |         | %      |

<sup>1</sup> 5PB11xxPGGI, 5PB11xxPGGK, 5PB11xxCMGI, 5PB11xxCMGK.  $T_A = -40^\circ C$  to  $+105^\circ C$  unless stated otherwise.

<sup>2</sup> 5PB1104CMG1 and 5PB1104CMT1 only.  $T_A = -40^\circ C$  to  $+125^\circ C$  unless stated otherwise.

<sup>3</sup> With rail-to-rail input clock.

<sup>4</sup> Between any 2 outputs with equal loading.

<sup>5</sup> Duty cycle on outputs will match incoming clock duty cycle when  $V_{IH}$  on CLKIN pin equals  $V_{DD}$  power supply voltage. Consult IDT for tight duty cycle clock generators.

Table 11. AC Electrical Characteristics –  $V_{DD} = 3.3V \pm 5\%$ 

| Symbol         | Parameter                                    | Applies to                             | Conditions   | Minimum | Typical | Maximum | Units  |
|----------------|--|--|--|---------|---------|---------|--------|
|                | Input Frequency                              | All devices                            |  | 0       |         | 200     | MHz    |
| $t_{OR}$       | Output Rise Time (2pF load)                  | Industrial and Extended <sup>[1]</sup> | 0.66V to 2.64V, $C_L = 2pF$ .                                |         | 0.45    | 0.6     | ns     |
| $t_{OF}$       | Output Fall Time (2pF load)                  | Industrial and Extended <sup>[1]</sup> | 2.64V to 0.66V, $C_L = 2pF$ .                                |         | 0.45    | 0.6     | ns     |
| $t_{OR}$       | Output Rise Time (5pF load)                  | Industrial and Extended <sup>[1]</sup> | 0.66V to 2.64V, $C_L = 5pF$ .                                |         | 0.7     | 1.0     | ns     |
| $t_{OF}$       | Output Fall Time (5pF load)                  | Industrial and Extended <sup>[1]</sup> | 2.64V to 0.66V, $C_L = 5pF$ .                                |         | 0.7     | 1.0     | ns     |
| $t_{OR}$       | Output Rise Time (5pF load)                  | Automotive <sup>[2]</sup>              | 0.66V to 2.64V, $C_L = 5pF$ .                                |         | 0.61    | 1.2     | ns     |
| $t_{OF}$       | Output Fall Time (5pF load)                  | Automotive <sup>[2]</sup>              | 2.64V to 0.66V, $C_L = 5pF$ .                                |         | 0.61    | 1.2     | ns     |
| $t_{START-UP}$ | Start-up Time                                | All devices                            | Part start-up time for valid outputs after $V_{DD}$ ramp-up. |         |         | 3       | ms     |
| $t_{PD}$       | Propagation Delay, 5PB1102/04 <sup>[3]</sup> | Industrial and Extended <sup>[1]</sup> |  | 1.7     |         | 2.4     | ns     |
|                | Propagation Delay, 5PB1106/08 <sup>[3]</sup> | Industrial and Extended <sup>[1]</sup> |  | 1.7     |         | 2.7     | ns     |
|                | Propagation Delay, 5PB1110 <sup>[3]</sup>    | Industrial and Extended <sup>[1]</sup> |  | 1.7     |         | 2.5     | ns     |
|                | Propagation Delay <sup>[3]</sup>             | Automotive <sup>[2]</sup>              |  | 1.0     |         | 3.4     | ns     |
|                | Buffer Additive Phase Jitter, RMS            | All devices                            | 156.25MHz, Integration Range: 12kHz–20MHz.                   |         |         | 0.05    | ps     |
|                | Output to Output Skew, 5PB1102/04            | Industrial and Extended <sup>[1]</sup> | Rising edges at $V_{DD}/2$ . <sup>[4]</sup>                  |         | 35      | 50      | ps     |
|                | Output to Output Skew, 5PB1106               | Industrial and Extended <sup>[1]</sup> | Rising edges at $V_{DD}/2$ . <sup>[4]</sup>                  |         | 35      | 58      | ps     |
|                | Output to Output Skew, 5PB1108/10            | Industrial and Extended <sup>[1]</sup> | Rising edges at $V_{DD}/2$ . <sup>[4]</sup>                  |         | 45      | 65      | ps     |
|                | Output to Output Skew                        | Automotive <sup>[2]</sup>              | Rising edges at $V_{DD}/2$ . <sup>[4]</sup>                  |         | 35      | 87      | ps     |
|                | Device to Device Skew                        | All devices                            | Rising edges at $V_{DD}/2$ .                                 |         |         | 200     | ps     |
| $t_{EN}$       | Output Enable Time                           | All devices                            | $C_L \leq 5pF$ .   |         |         | 3       | cycles |
| $t_{DIS}$      | Output Disable Time                          | All devices                            | $C_L \leq 5pF$ .   |         |         | 3       | cycles |
| $t_{DC}$       | Duty Cycle <sup>[5]</sup>                    | All devices                            |  |         | 50      |         | %      |

<sup>1</sup> 5PB11xxPGGI, 5PB11xxPGGK, 5PB11xxCMGI, 5PB11xxCMGK.  $T_A = -40^\circ C$  to  $+105^\circ C$  unless stated otherwise.

<sup>2</sup> 5PB1104CMG1 and 5PB1104CMT1 only.  $T_A = -40^\circ C$  to  $+125^\circ C$  unless stated otherwise.

<sup>3</sup> With rail-to-rail input clock.

<sup>4</sup> Between any 2 outputs with equal loading.

<sup>5</sup> Duty cycle on outputs will match incoming clock duty cycle when  $V_{IH}$  on CLKIN pin equals  $V_{DD}$  power supply voltage. Consult IDT for tight duty cycle clock generators.

## Phase Noise Plots

The phase noise plots show the low additive jitter of the 5PB11xx high-performance buffer. With an integration range of 12kHz to 20MHz, the reference input has about 58.9fs of RMS phase jitter while the output of 5PB11xx has about 70.9fs of RMS phase jitter. This results in a low additive phase jitter of only 39fs.

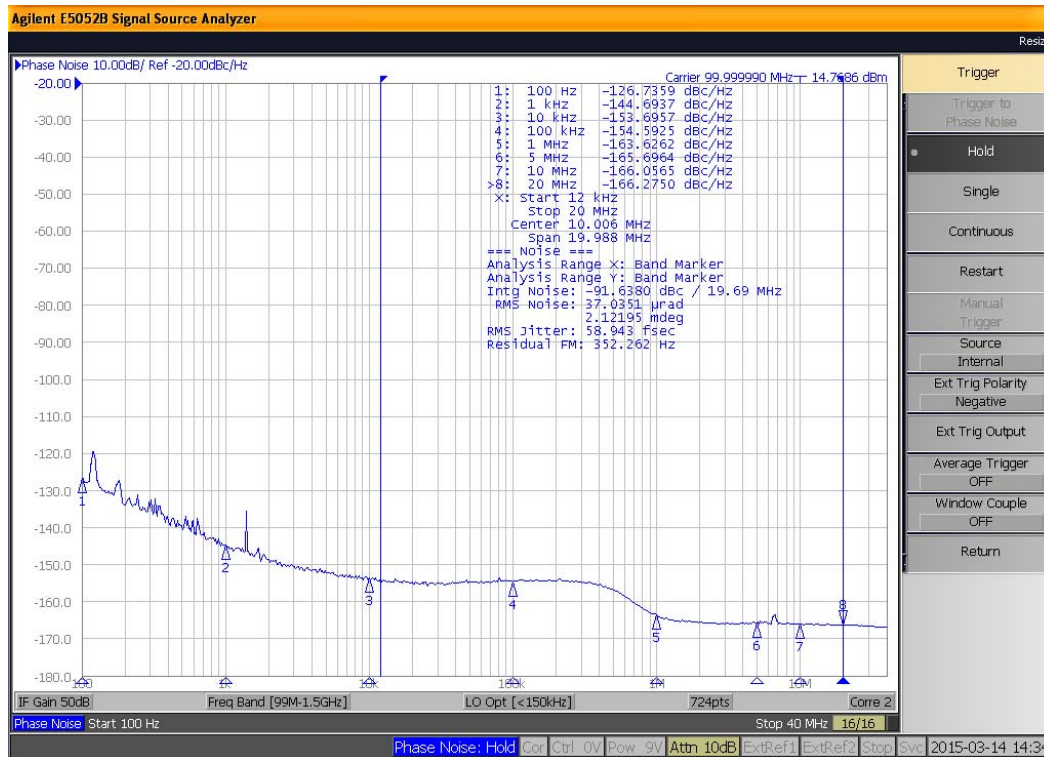

Reference Phase Noise 58.9fs (12kHz to 20MHz)

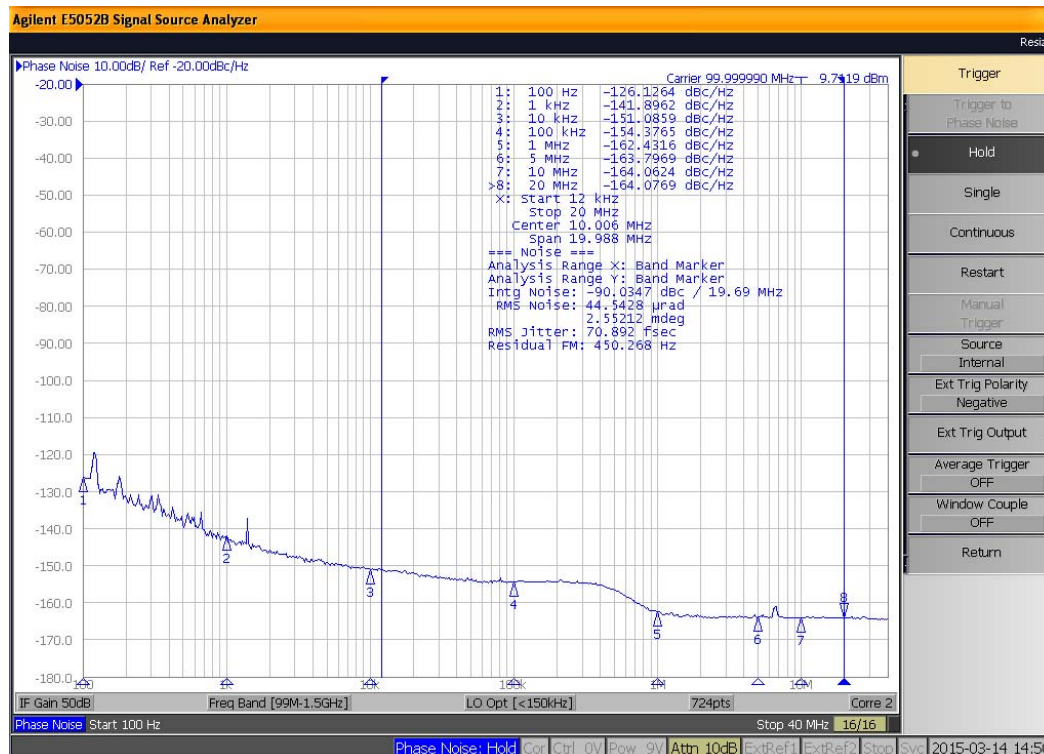

Output Phase Noise 70.9fs (12kHz to 20MHz)

## Test Load and Circuit

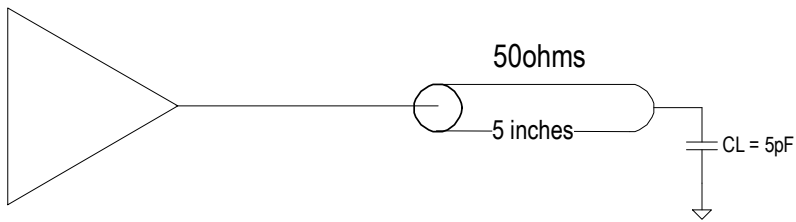

## Package Outline Drawings

The package outline drawings are appended at the end of this document and are accessible from the link below. The package information is the most current data available.

[www.idt.com/document/psc/8-tssop-package-outline-drawing-44-mm-body-065mm-pitch-pgg8d1](http://www.idt.com/document/psc/8-tssop-package-outline-drawing-44-mm-body-065mm-pitch-pgg8d1)

[www.idt.com/document/psc/14-tssop-package-outline-drawing-44mm-body-065mm-pitch-pgg14t1](http://www.idt.com/document/psc/14-tssop-package-outline-drawing-44mm-body-065mm-pitch-pgg14t1)

[www.idt.com/document/psc/16-tssop-package-outline-drawing-44mm-body-065mm-pitch-pgg16t1](http://www.idt.com/document/psc/16-tssop-package-outline-drawing-44mm-body-065mm-pitch-pgg16t1)

[www.idt.com/document/psc/20-tssop-package-outline-drawing-44-mm-body-065mm-pitch-pgg20d1](http://www.idt.com/document/psc/20-tssop-package-outline-drawing-44-mm-body-065mm-pitch-pgg20d1)

[www.idt.com/document/psc/cm8-package-outline-drawing-20-x-20-x-05-mm-body-05mm-pitch-dfn](http://www.idt.com/document/psc/cm8-package-outline-drawing-20-x-20-x-05-mm-body-05mm-pitch-dfn)

[www.idt.com/document/psc/cm16-package-outline-drawing-25-x-25-x-05-mm-body-040mm-pitch-vfqfn](http://www.idt.com/document/psc/cm16-package-outline-drawing-25-x-25-x-05-mm-body-040mm-pitch-vfqfn)

[www.idt.com/document/psc/20-vfqfn-package-outline-drawing-30-x-30-x-090-mm-040mm-pitch-165-x-165-mm-epad-ndg20p2](http://www.idt.com/document/psc/20-vfqfn-package-outline-drawing-30-x-30-x-090-mm-040mm-pitch-165-x-165-mm-epad-ndg20p2)

[www.idt.com/document/psc/dfn-8-package-outline-drawing-20-x-20-x-075-mm-body-050mm-pitch-cmt8d1](http://www.idt.com/document/psc/dfn-8-package-outline-drawing-20-x-20-x-075-mm-body-050mm-pitch-cmt8d1)

## Marking Diagrams (Industrial)

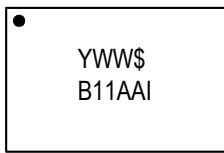

8-pin TSSOP

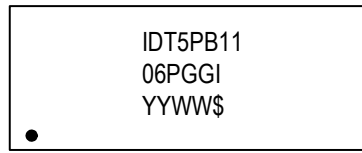

14-pin TSSOP

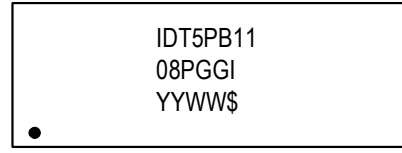

16-pin TSSOP

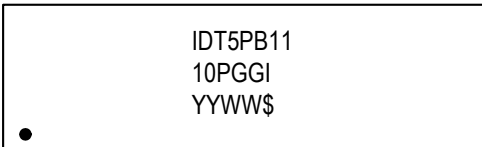

20-pin TSSOP

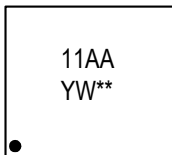

8-pin DFN

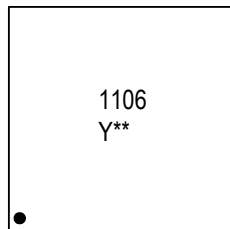

16-pin VFQFPN

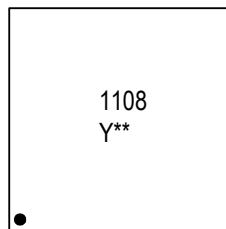

16-pin VFQFPN

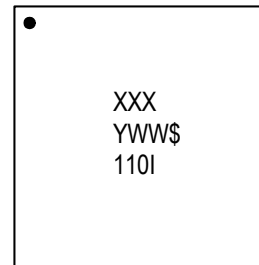

20-pin VFQFPN

- “AA” denotes the last two digits of the part number for 8-TSSOP and DFN (e.g. 02, 04).
- “\*\*\*” is the lot sequence.
- “XXX” denotes the last three characters of the Asm lot (20-VFQFPN only).
- “YYWW”, “YWW”, “YW”, or “Y” is the last digit(s) of the year and work week that the part was assembled.
- “\$” denotes the mark code.
- “G” after the two-letter package code denotes RoHS compliant package.
- “I” denotes industrial temperature range device.
- Bottom marking: LOT and COO (TSSOP only).

## Marking Diagrams (Extended)



8-pin TSSOP

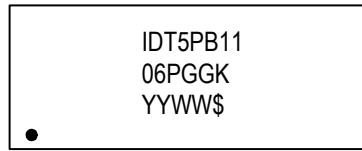

14-pin TSSOP

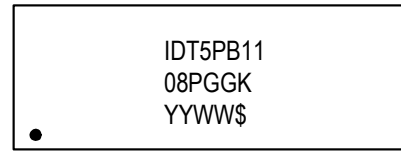

16-pin TSSOP



20-pin TSSOP



8-pin DFN

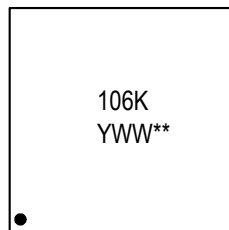

16-pin VFQFPN

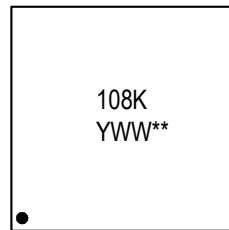

16-pin VFQFPN

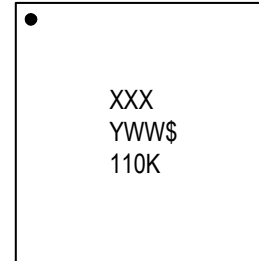

20-pin VFQFPN

- “AA” denotes the last two digits of the part number for 8-TSSOP and DFN (e.g. 02, 04).
- “\*\*” is the lot sequence.
- “XXX” denotes the last three characters of the Asm lot (20-VFQFPN only).
- “YYWW”, “YWW”, “YW”, or “Y” is the last digit(s) of the year and week that the part was assembled.
- “\$” denotes the mark code.
- “G” after the two-letter package code denotes RoHS compliant package.
- “K” denotes extended temperature range device.
- Bottom marking: LOT and COO (TSSOP only).

## Marking Diagrams (Automotive)

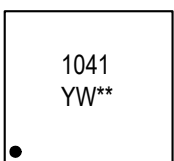

8-pin DFN

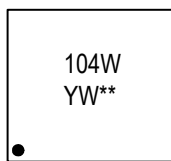

8-pin DFN (wetable flank)

- Line 1: truncated part number; last number is the temperature grade: 1 = Automotive Grade 1.
- “YW” is the last digit of the year and work week that the part was assembled.
- “\*\*” denotes the lot sequence number.



## Ordering Information (Industrial)

| Orderable Part Number | Package                        | Carrier Type  | Temperature  |
|-----------------------|--------------------------------|---------------|--------------|
| 5PB1102PGGI           | 4.4mm body, 8-TSSOP            | Tubes         | -40 to +85°C |
| 5PB1102PGGI8          |                                | Tape and Reel |              |
| 5PB1104PGGI           |                                | Tubes         |              |
| 5PB1104PGGI8          |                                | Tape and Reel |              |
| 5PB1106PGGI           | 4.4mm body, 14-TSSOP           | Tubes         |              |
| 5PB1106PGGI8          |                                | Tape and Reel |              |
| 5PB1108PGGI           | 4.4mm body, 16-TSSOP           | Tubes         |              |
| 5PB1108PGGI8          |                                | Tape and Reel |              |
| 5PB1110PGGI           | 4.4mm body, 20-TSSOP           | Tubes         |              |
| 5PB1110PGGI8          |                                | Tape and Reel |              |
| 5PB1102CMGI           | 2.0 × 2.0 × 0.5 mm, 8-DFN      | Cut Tape      |              |
| 5PB1102CMGI8          |                                | Tape and Reel |              |
| 5PB1104CMGI           |                                | Cut Tape      |              |
| 5PB1104CMGI8          |                                | Tape and Reel |              |
| 5PB1104CMGI/W*        |                                | Tape and Reel |              |
| 5PB1106CMGI           | 2.5 × 2.5 × 0.5 mm, 16-VFQFPN  | Cut Tape      |              |
| 5PB1106CMGI8          |                                | Tape and Reel |              |
| 5PB1108CMGI           |                                | Cut Tape      |              |
| 5PB1108CMGI8          |                                | Tape and Reel |              |
| 5PB1110NDGI           | 3.0 × 3.0 × 0.90 mm, 20-VFQFPN | Tubes         |              |
| 5PB1110NDGI8          |                                | Tape and Reel |              |

\* "/W" stands for tape and reel with pin 1 orientation: EIA-481-D. All other tape and reels options come with EIA-481-C pin 1 orientation.

## Ordering Information (Extended)

| Orderable Part Number | Package                        | Carrier Type  | Temperature   |
|-----------------------|--------------------------------|---------------|---------------|
| 5PB1102PGGK           | 4.4mm body, 8-TSSOP            | Tubes         | -40 to +105°C |
| 5PB1102PGGK8          |                                | Tape and Reel |               |
| 5PB1104PGGK           |                                | Tubes         |               |
| 5PB1104PGGK8          |                                | Tape and Reel |               |
| 5PB1106PGGK           | 4.4mm body, 14-TSSOP           | Tubes         |               |
| 5PB1106PGGK8          |                                | Tape and Reel |               |
| 5PB1108PGGK           | 4.4mm body, 16-TSSOP           | Tubes         |               |
| 5PB1108PGGK8          |                                | Tape and Reel |               |
| 5PB1110PGGK           | 4.4mm body, 20-TSSOP           | Tubes         |               |
| 5PB1110PGGK8          |                                | Tape and Reel |               |
| 5PB1102CMGK           | 2.0 × 2.0 × 0.5 mm, 8-DFN      | Cut Tape      |               |
| 5PB1102CMGK8          |                                | Tape and Reel |               |
| 5PB1104CMGK           |                                | Cut Tape      |               |
| 5PB1104CMGK8          |                                | Tape and Reel |               |
| 5PB1106CMGK           | 2.5 × 2.5 × 0.5 mm, 16-VFQFPN  | Cut Tape      |               |
| 5PB1106CMGK8          |                                | Tape and Reel |               |
| 5PB1108CMGK           |                                | Cut Tape      |               |
| 5PB1108CMGK8          |                                | Tape and Reel |               |
| 5PB1110NDGK           | 3.0 × 3.0 × 0.90 mm, 20-VFQFPN | Tubes         |               |
| 5PB1110NDGK8          |                                | Tape and Reel |               |

“G” after the two-letter package code denotes Pb-Free configuration, RoHS compliant.

## Ordering Information (Automotive)

| Orderable Part Number | Package                                      | Carrier Type  | Temperature    |
|-----------------------|--|---------------|----------------|
| 5PB1104CMG1           | 2.0 × 2.0 × 0.5 mm, 8-DFN                    | Cut Tape      | -40° to +125°C |
| 5PB1104CMG18          |  | Tape and Reel |                |
| 5PB1104CMT1           | 2.0 × 2.0 × 0.5 mm, 8-DFN,<br>Wettable flank | Cut Tape      | -40° to +125°C |
| 5PB1104CMT18          |  | Tape and Reel |                |

## Revision History

| Revision Date     | Description of Change   |
|-------------------|---|
| May 31, 2019      | <ul style="list-style-type: none"> <li>▪ Added 5PB1104CMT1 wettable flank package information.</li> <li>▪ Updated Propagation Delay values for automotive.</li> </ul> |
| December 18, 2018 | <ul style="list-style-type: none"> <li>▪ Updated <math>t_{PD}</math> and skew values.</li> <li>▪ Added 5PB1104CMG1 automotive part information.</li> </ul>            |
| October 24, 2018  | Initial release.  |



Corporate Headquarters  
 6024 Silver Creek Valley Road  
 San Jose, CA 95138 USA  
[www.IDT.com](http://www.IDT.com)

Sales  
 1-800-345-7015 or 408-284-8200  
 Fax: 408-284-2775  
[www.IDT.com/go/sales](http://www.IDT.com/go/sales)

Tech Support  
[www.IDT.com/go/support](http://www.IDT.com/go/support)

DISCLAIMER Integrated Device Technology, Inc. (IDT) and its affiliated companies (herein referred to as "IDT") reserve the right to modify the products and/or specifications described herein at any time, without notice, at IDT's sole discretion. Performance specifications and operating parameters of the described products are determined in an independent state and are not guaranteed to perform the same way when installed in customer products. The information contained herein is provided without representation or warranty of any kind, whether express or implied, including, but not limited to, the suitability of IDT's products for any particular purpose, an implied warranty of merchantability, or non-infringement of the intellectual property rights of others. This document is presented only as a guide and does not convey any license under intellectual property rights of IDT or any third parties.

IDT's products are not intended for use in applications involving extreme environmental conditions or in life support systems or similar devices where the failure or malfunction of an IDT product can be reasonably expected to significantly affect the health or safety of users. Anyone using an IDT product in such a manner does so at their own risk, absent an express, written agreement by IDT.

Integrated Device Technology, IDT and the IDT logo are trademarks or registered trademarks of IDT and its subsidiaries in the United States and other countries. Other trademarks used herein are the property of IDT or their respective third party owners. For datasheet type definitions and a glossary of common terms, visit [www.idt.com/go/glossary](http://www.idt.com/go/glossary). Integrated Device Technology, Inc. All rights reserved.