



Features

- Broadband 50MHz to 4000MHz Operation
- 6-Bit Digital Step Attenuator
- Serial Mode Programming
- Gain = -13.5dB to +18dB (0.5dB Step Size)
- High OIP3/P1dB = +36dB/20dBm
- Single +5V Supply
- Small 32-Pin, 5.2mm x 5.2mm, MCM (Footprint Compatible with 5mm x 5mm 32-Pin QFN)

Applications

- Cellular, 3G Infrastructure
- WiBro, WiMax, LTE
- Microwave Radio
- High Linearity Power Control

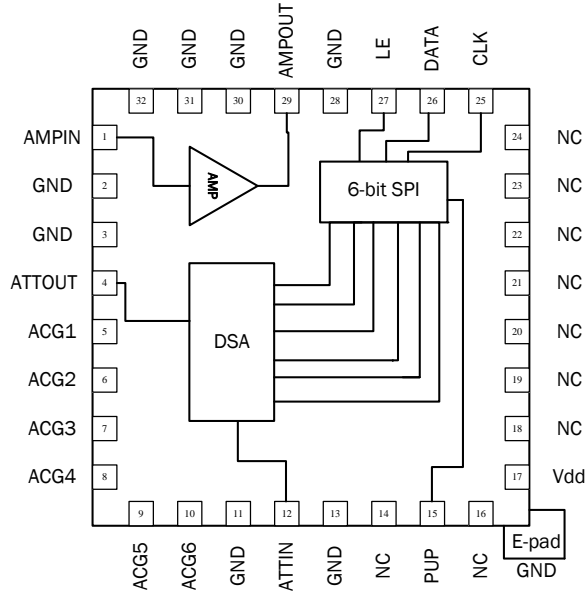

Functional Block Diagram

Product Description

RFMD's RDA1005L is a digitally controlled variable gain amplifier featuring high linearity over the entire gain control range with noise figure less than 6dB in its maximum gain state. The gain of the 6-bit digital step attenuator is programmed with a serial mode control interface. The RDA1005L is packaged in a small 5.2mm x 5.2mm leadless laminate MCM which contains plated through thermal vias for ultra-low thermal resistance. The footprint for this module is directly compatible with a 5mm x 5mm QFN. This module is easy to use with no external matching components required.

Ordering Information

RDA1005LSQ	Sample bag with 25 pieces
RDA1005LSR	7" Sample reel with 100 pieces
RDA1005LTR7	7" Reel with 750 pieces
RDA1005LTR13	13" Reel with 2500 pieces
RDA1005LPCK-410	50MHz to 4000MHz PCBA with 5-piece sample bag

Optimum Technology Matching® Applied

- | | | | |
|---|--------------------------------------|--|------------------------------------|
| <input type="checkbox"/> GaAs HBT | <input type="checkbox"/> SiGe BiCMOS | <input checked="" type="checkbox"/> GaAs pHEMT | <input type="checkbox"/> GaN HEMT |
| <input type="checkbox"/> GaAs MESFET | <input type="checkbox"/> Si BiCMOS | <input checked="" type="checkbox"/> Si CMOS | <input type="checkbox"/> BiFET HBT |
| <input checked="" type="checkbox"/> InGaP HBT | <input type="checkbox"/> SiGe HBT | <input type="checkbox"/> Si BJT | |

RF MICRO DEVICES®, RFMD®, Optimum Technology Matching®, Enabling Wireless Connectivity™, PowerStar®, POLARIS™ TOTAL RADIO™ and UltimateBlue™ are trademarks of RFMD, LLC. BLUETOOTH is a trademark owned by Bluetooth SIG, Inc., U.S.A. and licensed for use by RFMD. All other trade names, trademarks and registered trademarks are the property of their respective owners. ©2012, RF Micro Devices, Inc.

Absolute Maximum Ratings

Parameter	Rating	Unit
Supply Voltage	+5.5	V _{DC}
DC Supply Current	110	mA
Power Dissipation	605	mW
Max RF Input Power	20	dBm
Operating Temperature (T _{CASE})	-40 to +85	°C
Storage Temperature	-40 to +150	°C
Junction Temp	165*	°C
ESD Rating (HBM)	1000 (Class 1C)	V
Moisture Sensitivity Level	MSL3	

* MTTF = 1.0E6 hours at 165 °C junction temperature



Caution! ESD sensitive device.

Exceeding any one or a combination of the Absolute Maximum Rating conditions may cause permanent damage to the device. Extended application of Absolute Maximum Rating conditions to the device may reduce device reliability. Specified typical performance or functional operation of the device under Absolute Maximum Rating conditions is not implied.

The information in this publication is believed to be accurate and reliable. However, no responsibility is assumed by RF Micro Devices, Inc. ("RFMD") for its use, nor for any infringement of patents, or other rights of third parties, resulting from its use. No license is granted by implication or otherwise under any patent or patent rights of RFMD. RFMD reserves the right to change component circuitry, recommended application circuitry and specifications at any time without prior notice.



RFMD Green: RoHS compliant per EU Directive 2002/95/EC, halogen free per IEC 61249-2-21, < 1000ppm each of antimony trioxide in polymeric materials and red phosphorus as a flame retardant, and <2% antimony in solder.

Parameter	Specification			Unit	Condition
	Min.	Typ.	Max.		
General Parameters					TA = 25 °C, V _{DD} = 5V
Frequency Range	50		4000	MHz	
Gain Max 500MHz	17.5	19.0	20.5	dB	Attenuation = 0dB
Gain Max 2700MHz	15.5	17.5	18.5	dB	
Step Accuracy	±(0.1 +5% attenuation setting)			dB	Major state max error up to 2700MHz
Output P1dB 1900MHz		20		dBm	Attenuation = 0dB
Output P1dB 2700MHz		19		dBm	
Output IP3 1900MHz		36		dBm	
Output IP3 2700MHz		33		dBm	
Control Interface		6		bit	Serial mode
Settling Time		250		ns	t _{ON} , t _{OFF} (10/90% RF)
Noise Figure 1900MHz		6.3		dB	Attenuation = 0dB
Impedance		50		Ω	
Input Return Loss		-15		dB	
Output Return Loss		-15		dB	
Supply Voltage	4.75	5.0	5.25	V	
Supply Current		82		mA	
Thermal Resistance		80.7		°C/W	Junction to backside of device

Typical RF Performance at Key Operating Frequencies

(Note: Broadband Application Circuit)

Parameter	Unit	500MHz	850MHz	1.95GHz	2.4GHz	3.5GHz	4GHz
Maximum Small Signal Gain	dB	18.9	18.7	17.6	17.2	15.7	13.7
Output P1dB	dBm	20.5	20.4	20.4	19.4	16.9	14.7
Output IP3	dBm	39	40	36	34.8	28.5	27.1
Input Return Loss	dB	-36	-24	-16	-15	-14	-10
Output Return Loss	dB	-18	-22	-15	-11	-16	-27
Noise Figure	dB	5.5	5.5	5.9	6.2	-	-

Typical Performance - Broadband Application Circuit

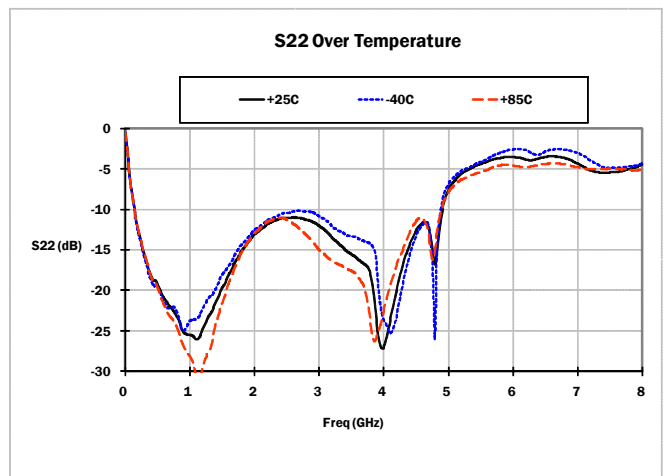
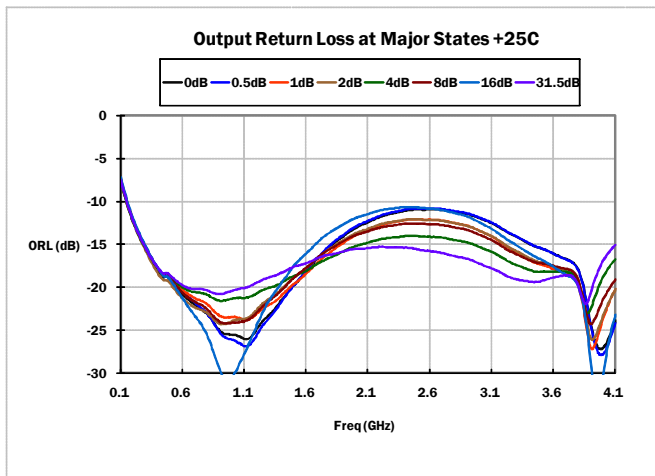
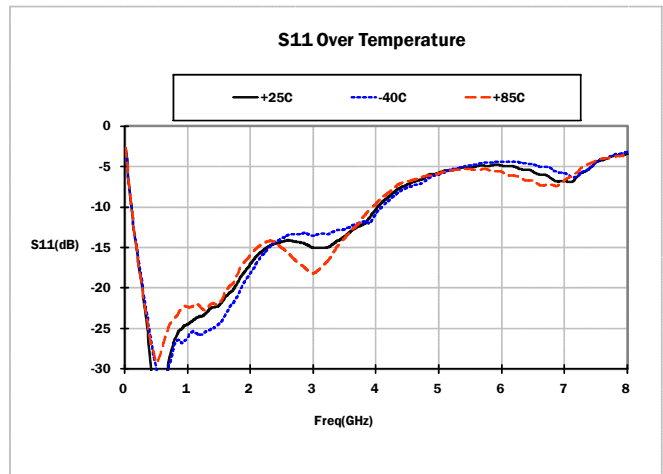
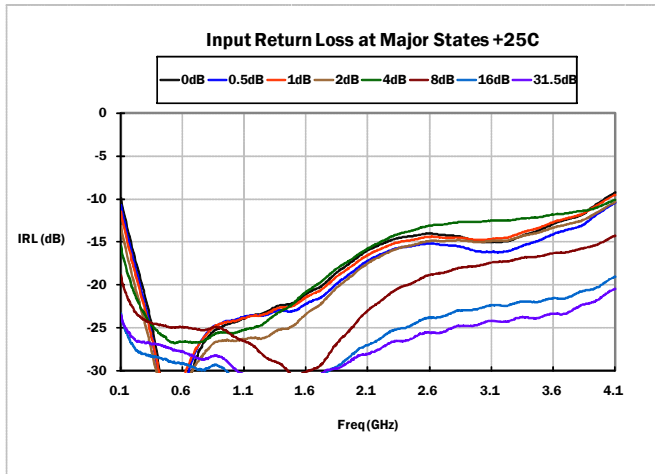
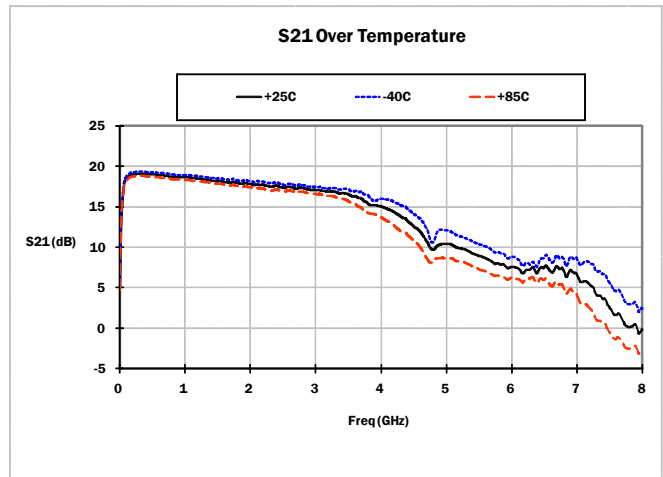
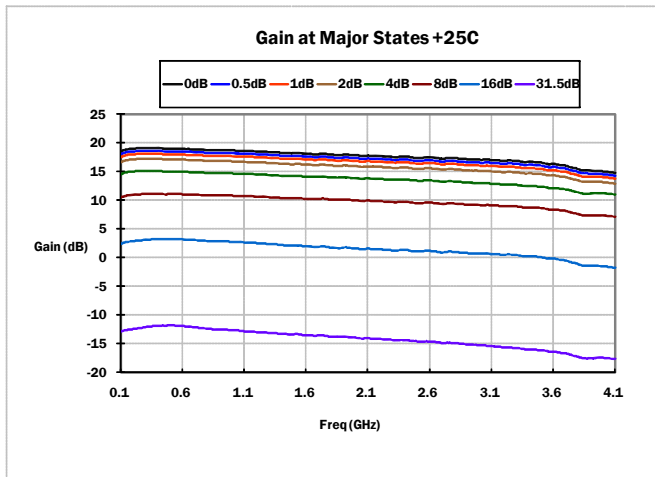

Typical Performance - Broadband Application Circuit

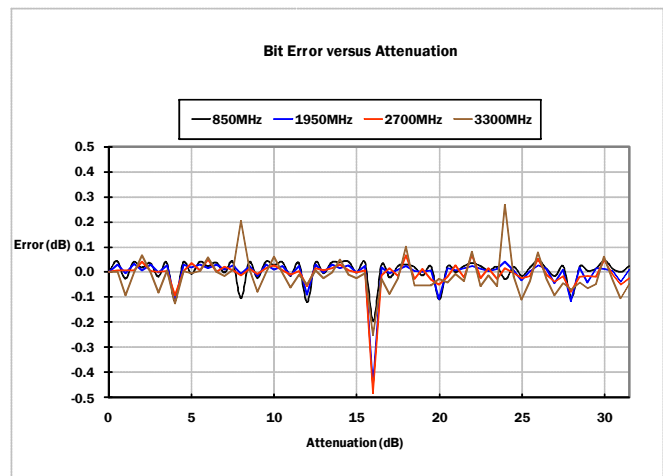
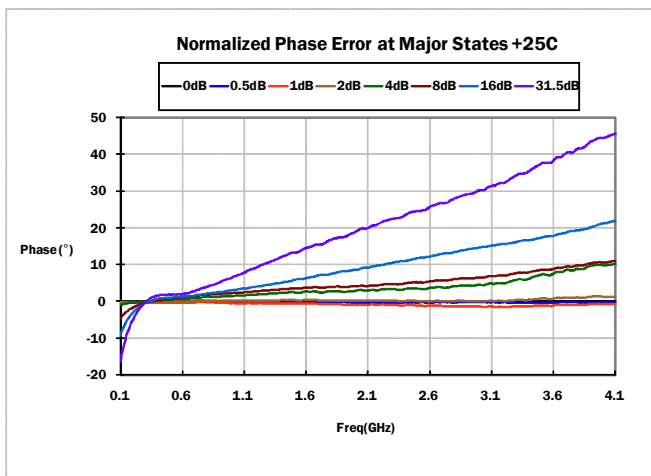
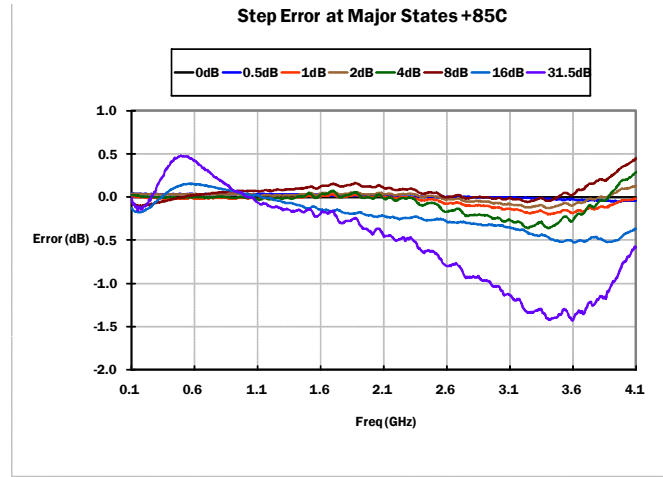
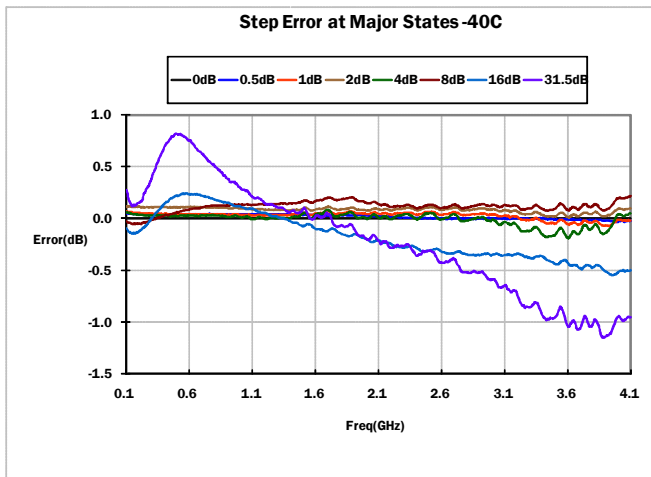
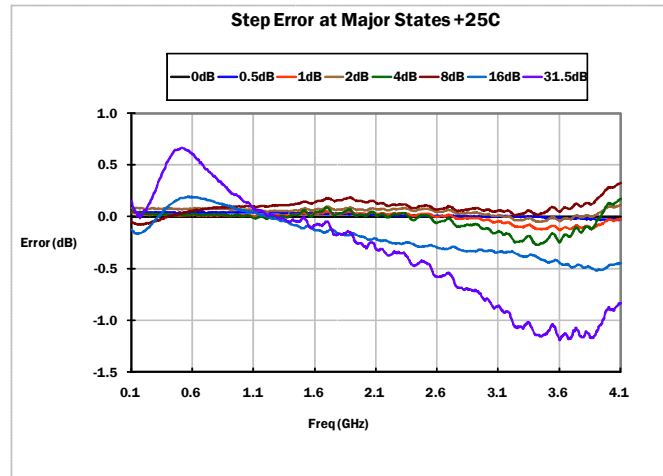
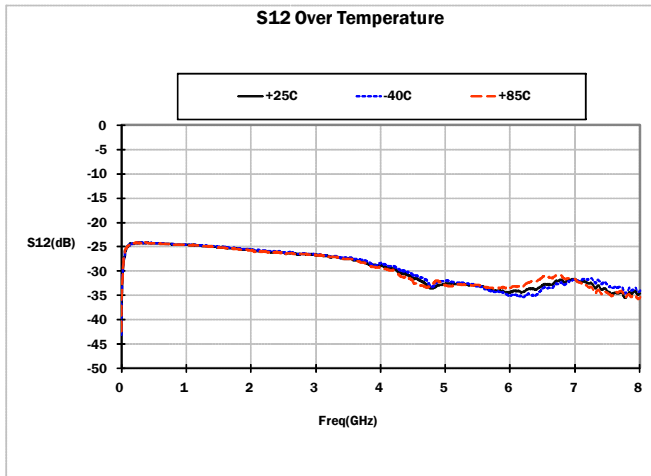

Typical Performance - Broadband Application Circuit

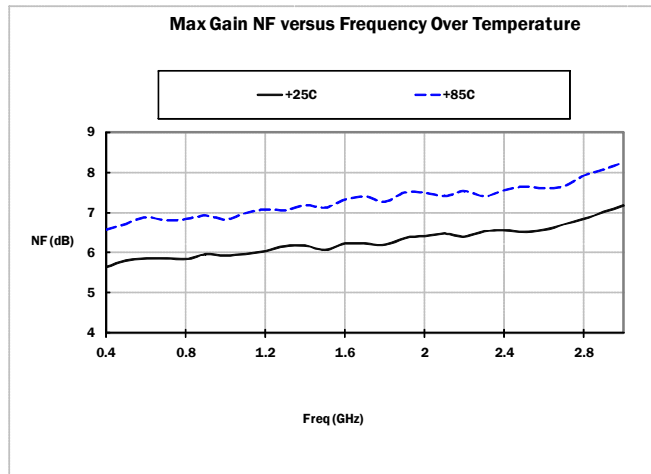
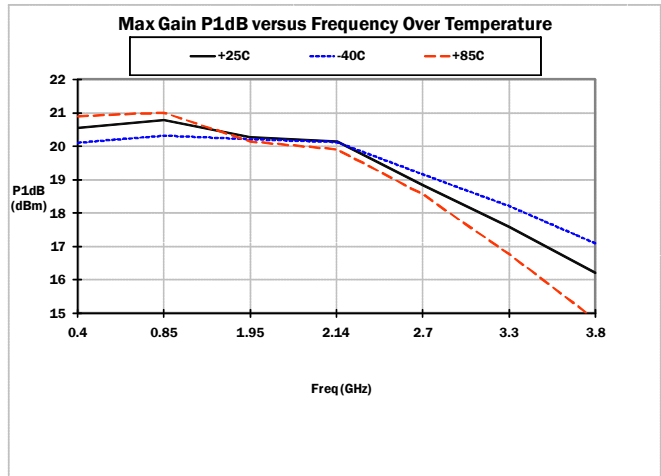
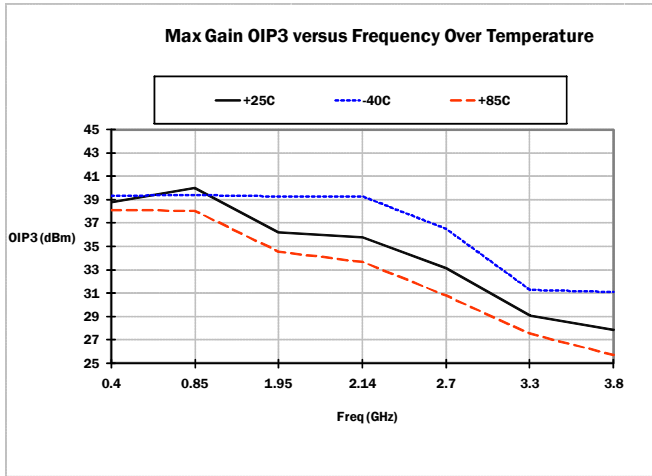

Truth Table

Control Bit						Gain Relative to Maximum Gain
D5	D4	D3	D2	D1	D0	
1	1	1	1	1	1	0dB
1	1	1	1	1	0	-0.5dB
1	1	1	1	0	1	-1dB
1	1	1	0	1	1	-2dB
1	1	0	1	1	1	-4dB
1	0	1	1	1	1	-8dB
0	1	1	1	1	1	-16dB
0	0	0	0	0	0	-31.5dB

Serial Port Interface:

SPI Timing Diagram

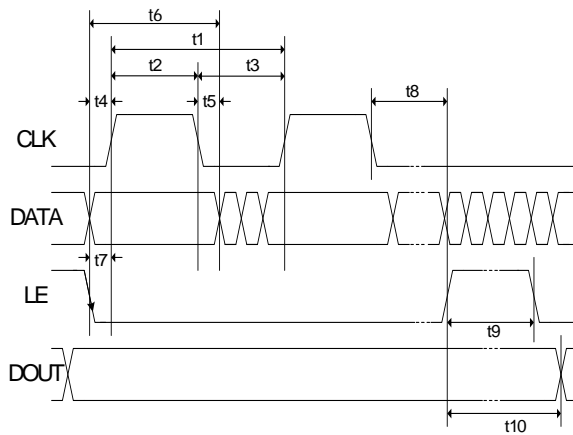

Programming example - 6-bit

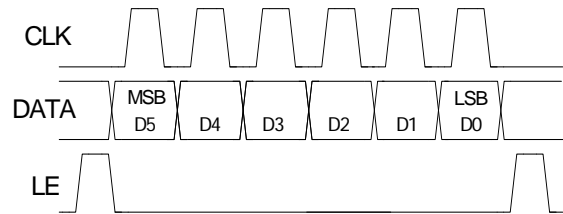

Specifications: SPI Timing Diagram

Parameter	Limit	Unit	Comment
t1	25	MHz max	CLK Frequency
t2	20	ns min	CLK High
t3	20	ns min	CLK Low
t4	5	ns min	DATA to CLK Setup Time
t5	5	ns min	DATA to CLK Hold Time
t6	30	ns min	DATA Valid
t7	5	ns min	LE to CLK Setup Time
t8	5	ns min	CLK to LE Setup Time
t9	10	ns min	LE Pulse Width
t10	20	ns max	Output Set

Control Voltage Table		
State	V _{DD} = +3V	V _{DD} = +5V
Low	0V to 0.8V	0V to 0.8V
High	2.0 to V _{DD}	2.0 to V _{DD}

Power-up Programming Truth Table	
PUP	Attenuator Setting
Low	Attenuation at Max, 31.5dB
High	Attenuation at Min, 0dB

Evaluation Board Schematic

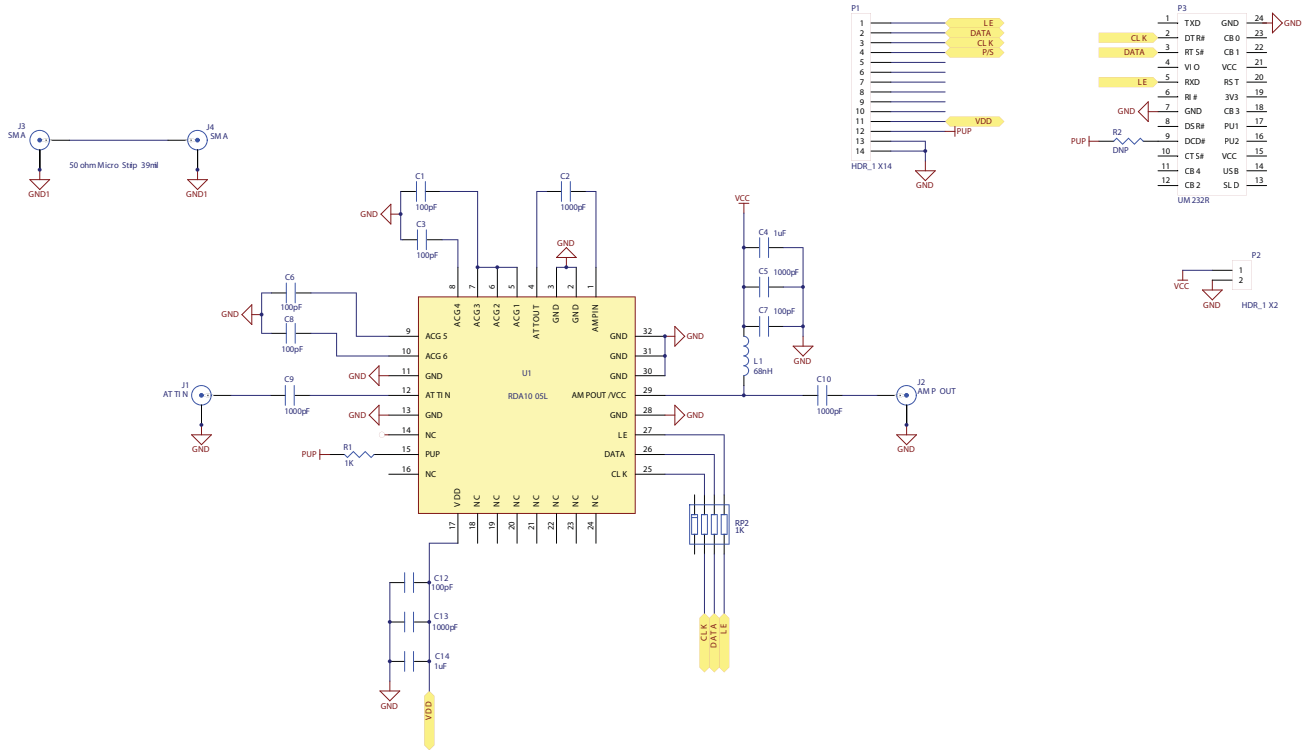

Evaluation Board Bill of Materials (BOM)

Description	Reference Designator	Manufacturer	Manufacturer's P/N
RDA1005L w/USB Evaluation Board	PCB Itself	Dynamic Details (DDI) Toronto	RDA1005L410(C)
RDA1005L, 5.2 x 5.2 sq. mm, 32-Pin Laminate	U1	RFMD	RDA1005LSB
CAP, 1000pF, 10%, 50V, X7R, 0402	C2, C9-C10	Murata Electronics	GRM155R71H102KA01E
CAP, 1µF, 10%, 16V, X7R, 0805	C4, C14	Murata Electronics	GRM21BR71C105KA01K
CAP, 1000pF, 10%, 50V, X7R, 0603	C5, C13	Murata Electronics	GRM188R71H102KA01D
CAP, 100pF, 5%, 50V, COG, 0402	C1, C3, C6-C8, C12	Murata Electronics	GRM1555C1H101JD01D
IND, 68nH, 5%, W/W, 0603	L1	Coilcraft	1008CS-680XJLC
RES ARRAY, 4-ELEM, 1K, 5%, SMD 4 X 0402	R1	Panasonic Industrial	ERJ-2RKF1001
RES ARRAY, 4-ELEM, 1K, 5%, SMD 4 X 0402	RP2	KOA	CN1E4KTTD102J
CONN, SMA, END LNCH, FLT, 0.062"	J1-J4	Emerson Network Power	142-0701-821
CONN, HDR, ST, PLRZD, 14-PIN, 0.100"	P1	ITW Pancon	MPSS100-14-C
CONN, HDR, ST, PLRZD, 2-PIN, 0.100"	P2	ITW Pancon	MPSS100-2-C
CONN, SKT, 24-Pin DIP, 0.600", T/H	P3	Aries Electronics Inc.	24-6518-10
MOD, USB TO SERIAL UART, SSOP-28	M1 [1]	Future Technology Devices Int'l	UM232R
DNP or DNI	C11, R2, RP3-RP4	N/A	N/A

Notes:

[1] M1 is to be mounted into P3 with respect to the Pin 1 alignment of M1 and P3.

Evaluation Board Assembly Drawing

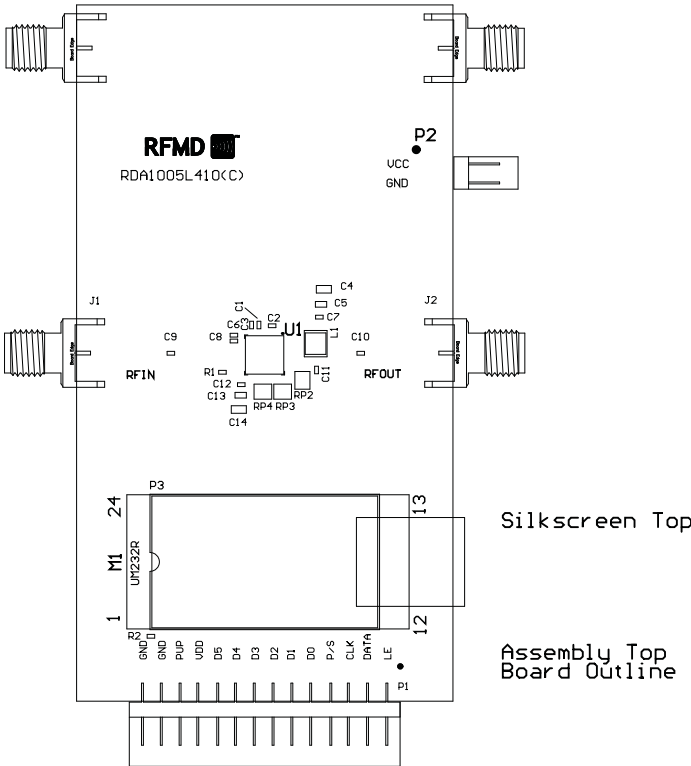

Pin Names and Descriptions

Pin	Name	Description
1	AMPIN	RF Amplifier Input.
2	GND	RF/DC Ground Connection.
3	GND	RF/DC Ground Connection.
4	ATTOUT	Digital Attenuator Output.
5	ACG1	Place external capacitor to ground.
6	ACG2	Place external capacitor to ground.
7	ACG3	Place external capacitor to ground.
8	ACG4	Place external capacitor to ground.
9	ACG5	Place external capacitor to ground.
10	ACG6	Place external capacitor to ground.
11	GND	RF/DC Ground Connection.
12	ATTIN	Digital Attenuator Input.
13	GND	RF/DC Ground Connection.
14	NC	No connection; leave open or ground.
15	PUP	Power up programming pin. Low = Max attenuation setting at power up, -31.5dB High = Min attenuation setting at power up, 0dB
16	NC	No Connection, leave open or GND.
17	VDD	Supply Voltage.
18	NC	No Connection, leave open or GND.
19	NC	No Connection, leave open or GND.
20	NC	No Connection, leave open or GND.
21	NC	No Connection, leave open or GND.
22	NC	No Connection, leave open or GND.
23	NC	No Connection, leave open or GND.
24	NC	No Connection, leave open or GND.
25	CLK	Serial Clock.
26	DATA	Serial Data.
27	LE	Latch Enable.
28	GND	RF/DC Ground Connection.
29	AMPOUT	RF Amplifier Output.
30	GND	RF/DC Ground Connection.
31	GND	RF/DC Ground Connection.
32	GND	RF/DC Ground Connection.

Package Drawing 5.2mm x 5.2mm Laminate Module

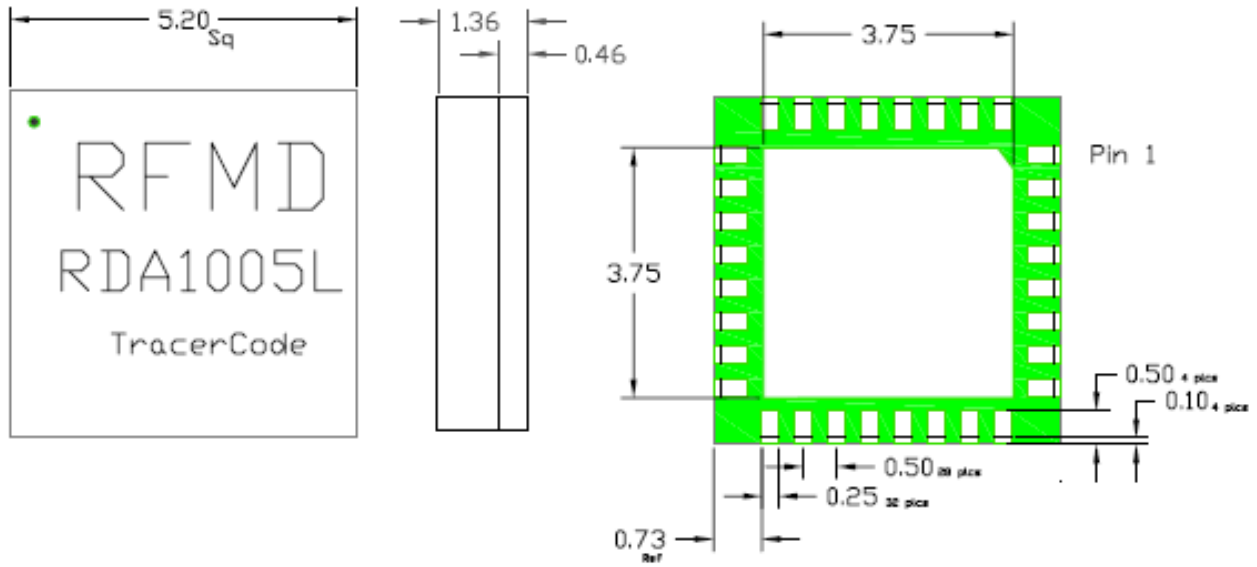

Branding Diagram

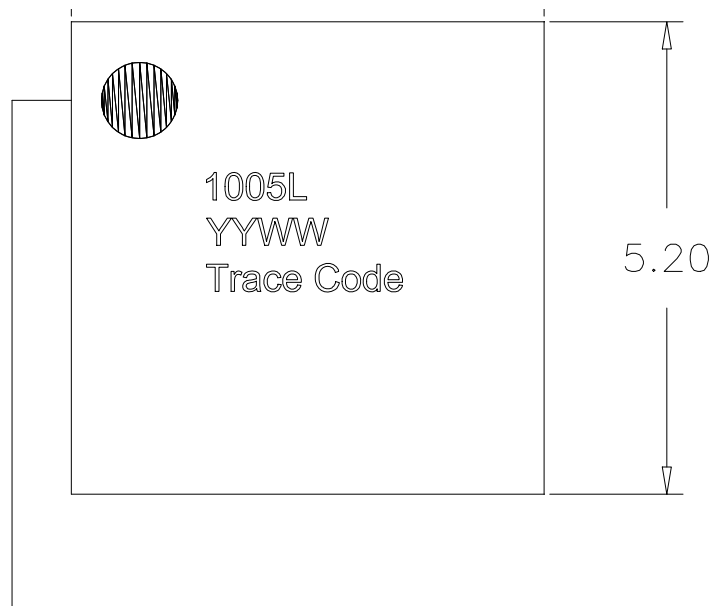

Pin 1 Indicator
 YY = Year
 WW = Week