

THESE DRAWINGS ARE THE PROPERTY OF QUALTEK ELECTRONICS AND NOT TO BE REPRODUCED FOR OR COMMUNICATED TO A THIRD PARTY WITHOUT THE EXPRESS WRITTEN PERMISSION OF AN OFFICER OF QUALTEK ELECTRONICS.

REVISION			
REV.	DESCRIPTION	DATE	APPROVED

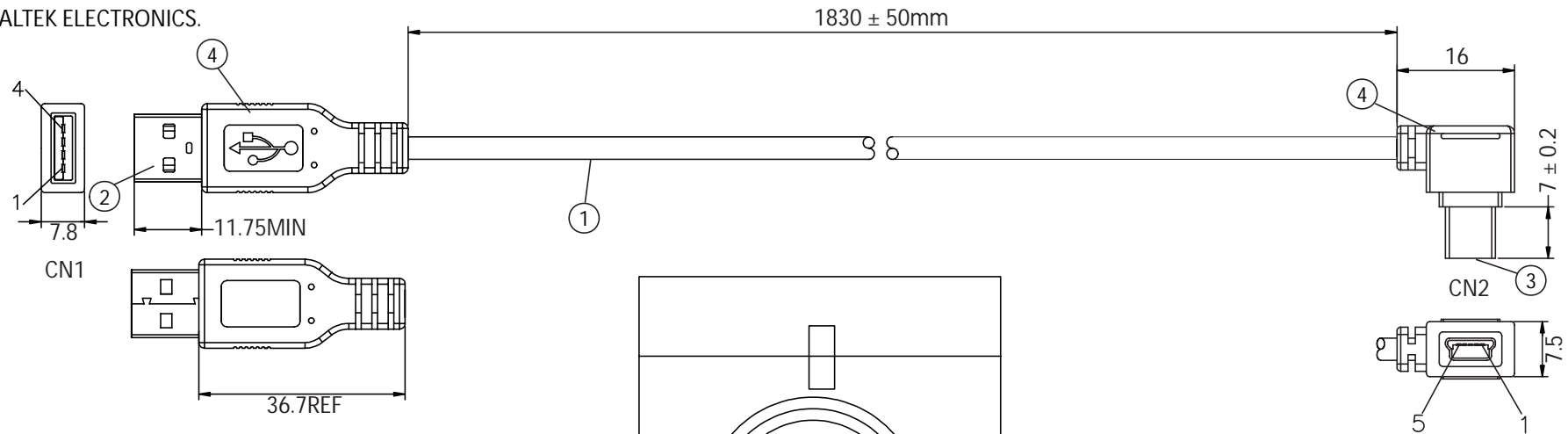

P/N: 3021098-06
 USB 4P(A) MALE TO MINI 5P(B) MALE
 Length: 6FT
 Color: White

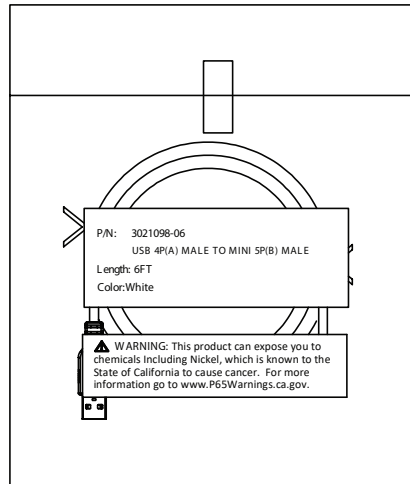

CONNECTION

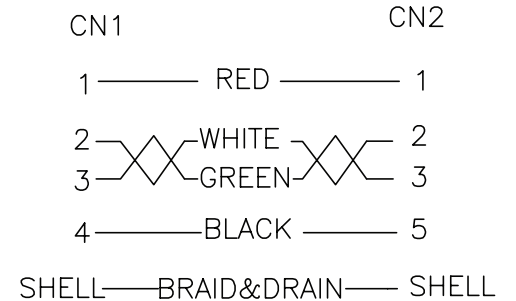

NOTES:

- CABLE: UL2725
 28AWGx1PR+24AWGx2C+ AEB(AL) 65%
 OUTER JACKET: WHITE, OD: 4.2 ± 0.2mm
- CONNECTOR: USB 2.0 A TYPE MALE
 INSULATOR: WHITE PBT
 PIN G/F
 NICKEL PLATED SHELL
- CONNECTOR: MINI USB 2.0 (B) 5P/M TYPE MALE
 INSULATOR: BLACK PBT
 PIN G/F
 NICKEL PLATED SHELL
- PVC MOLDED: COLOR 45P WHITE
- ELECTRICAL TEST:
 <1>.100% OPEN SHORT & MISS WIRE TEST
 <2>.INSULATION RESISTANCE: AC 300V DC300V 10M ohm MIN.
 <3>.CONDUCTOR RESISTANCE: 1 ohm MAX.
- PACKING: 1PC/POLYBAG W/ LABEL

CONTROLLED

Dim range (mm)	Tolerance +/- (mm)	Qualtek Electronics Corp. WCI DIVISION		
		Part Number: 3021098-06	RoHS Compliant	
0-1	0.40	Description: USB 4P(A)/M - MINI USB 5P(B)/M		
1-6	0.45			
6-18	0.50		UNIT: mm	
18-50	0.60			
50-120	0.70	Drawn / Date	Checked / Date	Approved / Date
120-250	0.90	R. Nuti 03-05-19	03-05-19	LY / 03-05-19
250-500	1.20			

Mouser Electronics

Authorized Distributor

Click to View Pricing, Inventory, Delivery & Lifecycle Information:

[Qualtek:](#)

[3021098-06](#)