



FEATURES

Enhanced product features

- Supports defense and aerospace applications (AQEC)
- Military temperature range (-55°C to $+125^{\circ}\text{C}$)
- Controlled manufacturing baseline
- One assembly/test site
- One fabrication site
- Enhanced product change notification
- Qualification data available on request
- Four buffered 12-Bit DACs in 10-lead MSOP
- S Version: ± 10 LSB INL
- Low power operation: 500 μA at 3 V, 600 μA at 5 V
- 2.5 V to 5.5 V power supply
- Guaranteed monotonic by design over all codes
- Power-down to 80 nA at 3 V, 200 nA at 5 V
- Double-buffered input logic
- Output range: 0 V to V_{REF}
- Power-on reset to 0 V
- Simultaneous update of outputs ($\overline{\text{LDAC}}$ function)
- On-chip, rail-to-rail output buffer amplifiers
- Temperature range -55°C to $+125^{\circ}\text{C}$

APPLICATIONS

- Portable battery-powered instruments
- Digital gain and offset adjustment
- Programmable voltage and current sources
- Programmable attenuators
- Industrial process control

GENERAL DESCRIPTION

The AD5324-EP¹ is a quad 12-bit buffered voltage output digital-to-analog converter (DAC) in a 10-lead MSOP package that operates from a single 2.5 V to 5.5 V supply, consuming 500 μA at 3 V. The on-chip output amplifiers allows rail-to-rail output swing to be achieved with a slew rate of 0.7 V/ μs . A 3-wire serial interface is used; it operates at clock rates up to 30 MHz and is compatible with standard serial peripheral interface (SPI), QSPI[™], MICROWIRE[™], and DSP interface standards.

The references for the four DACs are derived from one reference pin. The outputs of all DACs can be updated simultaneously using the software $\overline{\text{LDAC}}$ function. The part incorporates a power-on reset circuit and ensures that the DAC outputs power up to 0 V and remains there until a valid write takes place to the device. The part contains a power-down feature that reduces the current consumption of the device to 200 nA at 5 V (80 nA at 3 V).

The low power consumption of this part in normal operation makes it ideally suited to portable battery-operated equipment. The power consumption is 3 mW at 5 V, and 1.5 mW at 3 V, reducing to 1 μW in power-down mode.

Full details about this enhanced product are available in the [AD5324](#) data sheet, which must be consulted in conjunction with this data sheet.

¹ Protected by U.S. Patent No. 5,969,657.

FUNCTIONAL BLOCK DIAGRAM

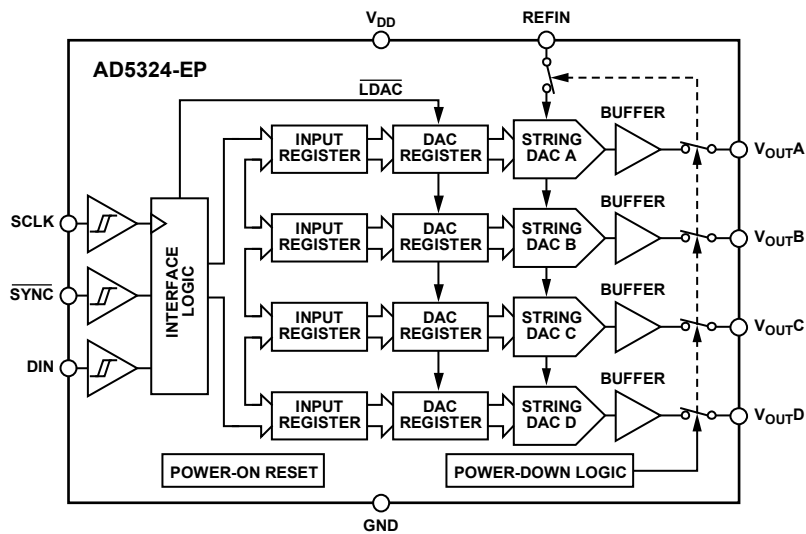

Figure 1.

TABLE OF CONTENTS

| | | | |
|--------------------------------|---|--|----|
| Features | 1 | Timing Characteristics | 5 |
| Applications..... | 1 | Absolute Maximum Ratings | 6 |
| General Description | 1 | ESD Caution..... | 6 |
| Functional Block Diagram | 1 | Pin Configuration and Function Descriptions..... | 7 |
| Revision History | 2 | Typical Performance Characteristics | 8 |
| Specifications..... | 3 | Outline Dimensions | 11 |
| AC Characteristics..... | 4 | Ordering Guide | 11 |

REVISION HISTORY

6/2019—Rev. 0 to Rev. A

| | |
|--|----|
| Changes to Patent Information..... | 1 |
| Changes to Offset Error Parameter, Table 1 and Gain Error Parameter, Table 1..... | 3 |
| Changes to Peak Temperature Parameter, Table 4 | 6 |
| Updated Outline Dimensions | 11 |

4/2010—Revision 0: Initial Version

SPECIFICATIONS

$V_{DD} = 2.5\text{ V to }5.5\text{ V}$; $V_{REF} = 2\text{ V}$; $R_L = 2\text{ k}\Omega$ to GND; $C_L = 200\text{ pF}$ to GND; all specifications T_{MIN} to T_{MAX} , unless otherwise noted.

Table 1.

| Parameter | S Version | | | Unit | Conditions/Comments | |
|--|-----------|---|----------|--------------------------------|---|---|
| | Min | Typ | Max | | | |
| DC PERFORMANCE¹ | | | | | | |
| Resolution | | 12 | | Bits | | |
| Relative Accuracy | | ± 2 | ± 10 | LSB | | |
| Differential Nonlinearity ² | | ± 0.2 | ± 1 | LSB | Guaranteed monotonic by design over all codes | |
| Offset Error | | ± 0.4 | ± 3 | % of FSR | See Figure 6 and Figure 8 | |
| Gain Error | | ± 0.15 | ± 1 | % of FSR | See Figure 6 and Figure 8 | |
| Lower Dead Band | | 20 | 60 | mV | Lower dead band exists only if offset error is negative | |
| Offset Error Drift ³ | | -12 | | ppm of FSR/ $^{\circ}\text{C}$ | | |
| Gain Error Drift ³ | | -5 | | ppm of FSR/ $^{\circ}\text{C}$ | | |
| DC Power Supply Rejection Ratio ³ | | -60 | | dB | $\Delta V_{DD} = \pm 10\%$ | |
| DC Crosstalk ³ | | 200 | | μV | $R_L = 2\text{ k}\Omega$ to GND or V_{DD} | |
| DAC REFERENCE INPUTS³ | | | | | | |
| V_{REF} Input Range | 0.25 | | V_{DD} | V | | |
| V_{REF} Input Impedance | 37 | 45 | | k Ω | Normal operation | |
| | | >10 | | M Ω | Power-down mode | |
| Reference Feedthrough | | -90 | | dB | Frequency = 10 kHz | |
| OUTPUT CHARACTERISTICS³ | | | | | | |
| Minimum Output Voltage ⁴ | | 0.001 | | V | Measurement of the minimum and maximum V drive capability of the output amplifier | |
| Maximum Output Voltage ⁴ | | $V_{DD} - 0.001$ | | | | |
| DC Output Impedance | | 0.5 | | Ω | | |
| Short Circuit Current | | 25 | | mA | $V_{DD} = 5\text{ V}$ | |
| | | 16 | | mA | $V_{DD} = 3\text{ V}$ | |
| Power-Up Time | | 2.5 | | μs | Coming out of power-down mode $V_{DD} = 5\text{ V}$ | |
| | | 5 | | μs | Coming out of power-down mode $V_{DD} = 3\text{ V}$ | |
| LOGIC INPUTS³ | | | | | | |
| Input Current | | | ± 1 | μA | | |
| V_{IL} , Input Low Voltage | | | 0.8 | V | $V_{DD} = 5\text{ V} \pm 10\%$ | |
| | | | 0.6 | V | $V_{DD} = 3\text{ V} \pm 10\%$ | |
| | | | 0.5 | V | $V_{DD} = 2.5\text{ V}$ | |
| V_{IH} , Input High Voltage | 2.4 | | | V | $V_{DD} = 5\text{ V} \pm 10\%$ | |
| | 2.1 | | | V | $V_{DD} = 3\text{ V} \pm 10\%$ | |
| | 2.0 | | | V | $V_{DD} = 2.5\text{ V}$ | |
| Pin Capacitance | | 3 | | pF | | |
| POWER REQUIREMENTS | | | | | | |
| V_{DD} | 2.5 | | 5.5 | V | | |
| I_{DD} (Normal Mode) ⁵ | | $V_{DD} = 4.5\text{ V to }5.5\text{ V}$ | 600 | 900 | μA | $V_{IH} = V_{DD}$ and $V_{IL} = \text{GND}$ |
| | | $V_{DD} = 2.5\text{ V to }3.6\text{ V}$ | 500 | 700 | μA | $V_{IH} = V_{DD}$ and $V_{IL} = \text{GND}$ |
| I_{DD} (Power-Down Mode) | | $V_{DD} = 4.5\text{ V to }5.5\text{ V}$ | 0.2 | 1 | μA | $V_{IH} = V_{DD}$ and $V_{IL} = \text{GND}$ |
| | | $V_{DD} = 2.5\text{ V to }3.6\text{ V}$ | 0.08 | 1 | μA | $V_{IH} = V_{DD}$ and $V_{IL} = \text{GND}$ |

¹ DC specifications tested with the outputs unloaded.

² Linearity is tested using a reduced code range: Code 115 to Code 3981.

³ Guaranteed by design and characterization, not production tested.

⁴ For the amplifier output to reach the minimum voltage, offset error must be negative. For the amplifier output to reach the maximum voltage, $V_{REF} = V_{DD}$ and offset plus gain error must be positive.

⁵ I_{DD} specification is valid for all DAC codes; interface inactive; all DACs active; load currents excluded.

AC CHARACTERISTICS

$V_{DD} = 2.5\text{ V}$ to 5.5 V ; $R_L = 2\text{ k}\Omega$ to GND; $C_L = 200\text{ pF}$ to GND; all specifications T_{MIN} to T_{MAX} , unless otherwise noted.

Table 2.

| Parameter ¹ | S Version ² | | | Unit | Conditions/Comments |
|-------------------------------------|------------------------|-----|-----|----------------------------|---|
| | Min | Typ | Max | | |
| Output Voltage Settling Time | | 8 | 10 | μs | $V_{REF} = V_{DD} = 5\text{ V}$ $\frac{1}{4}$ scale to $\frac{3}{4}$ scale change (0x400 to 0xC00) |
| Slew Rate | | 0.7 | | $\text{V}/\mu\text{s}$ | |
| Major Code Transition Glitch Energy | | 12 | | $\text{nV}\cdot\text{sec}$ | 1 LSB change around major carry |
| Digital Feedthrough | | 1 | | $\text{nV}\cdot\text{sec}$ | |
| Digital Crosstalk | | 1 | | $\text{nV}\cdot\text{sec}$ | |
| DAC-to-DAC Crosstalk | | 3 | | $\text{nV}\cdot\text{sec}$ | |
| Multiplying Bandwidth | | 200 | | kHz | $V_{REF} = 2\text{ V} \pm 0.1\text{ V p-p}$ |
| Total Harmonic Distortion | | -70 | | dB | $V_{REF} = 2.5\text{ V} \pm 0.1\text{ V p-p}$; frequency = 10 kHz |

¹ Guaranteed by design and characterization, not production tested.

² Temperature range (S Version): -55°C to $+125^\circ\text{C}$; typical at $+25^\circ\text{C}$.

TIMING CHARACTERISTICS

$V_{DD} = 2.5\text{ V to }5.5\text{ V}$; all specifications T_{MIN} to T_{MAX} , unless otherwise noted.

Table 3.

| Parameter ^{1, 2, 3} | Limit at T_{MIN}, T_{MAX} | | Unit | Conditions/Comments |
|------------------------------|---|---|--------|---|
| | $V_{DD} = 2.5\text{ V to }3.6\text{ V}$ | $V_{DD} = 3.6\text{ V to }5.5\text{ V}$ | | |
| t_1 | 40 | 33 | ns min | SCLK cycle time |
| t_2 | 16 | 13 | ns min | SCLK high time |
| t_3 | 16 | 13 | ns min | SCLK low time |
| t_4 | 16 | 13 | ns min | $\overline{\text{SYNC}}$ to SCLK falling edge setup time |
| t_5 | 5 | 5 | ns min | Data setup time |
| t_6 | 4.5 | 4.5 | ns min | Data hold time |
| t_7 | 0 | 0 | ns min | SCLK falling edge to $\overline{\text{SYNC}}$ rising edge |
| t_8 | 80 | 33 | ns min | Minimum $\overline{\text{SYNC}}$ high time |

¹ Guaranteed by design and characterization, not production tested.

² All input signals are specified with $t_r = t_f = 5\text{ ns}$ (10% to 90% of V_{DD}) and timed from a voltage level of $(V_{IL} + V_{IH})/2$.

³ See Figure 2.

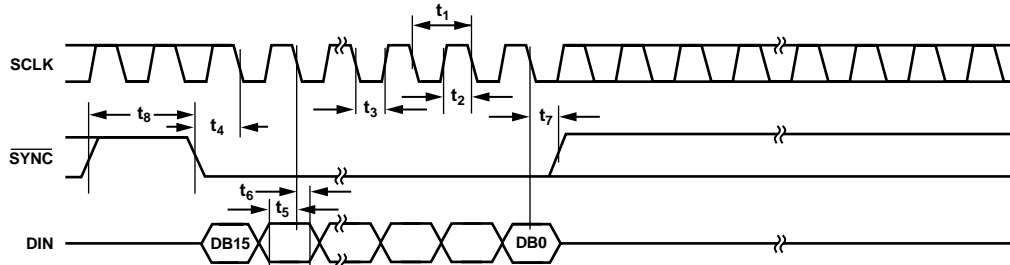

Figure 2. Serial Interface Timing Diagram

200-07860

ABSOLUTE MAXIMUM RATINGS

$T_A = 25^\circ\text{C}$, unless otherwise noted.

Table 4.

| Parameter ¹ | Rating |
|--------------------------------------|---|
| V_{DD} to GND | -0.3 V to +7 V |
| Digital Input Voltage to GND | -0.3 V to $V_{DD} + 0.3$ V |
| Reference Input Voltage to GND | -0.3 V to $V_{DD} + 0.3$ V |
| V_{OUTA} through V_{OUTD} to GND | -0.3 V to $V_{DD} + 0.3$ V |
| Operating Temperature Range | |
| Industrial (EP Version) | -55°C to $+125^\circ\text{C}$ |
| Storage Temperature Range | -65°C to $+150^\circ\text{C}$ |
| Junction Temperature (T_J max) | 150°C |
| 10-Lead MSOP | |
| Power Dissipation | $(T_J \text{ max} - T_A) / \theta_{JA}$ |
| θ_{JA} Thermal Impedance | $206^\circ\text{C}/\text{W}$ |
| θ_{JC} Thermal Impedance | $44^\circ\text{C}/\text{W}$ |
| Reflow Soldering | |
| Peak Temperature | 260°C |
| Time at Peak Temperature | 10 sec to 40 sec |

¹ Transient currents of up to 100 mA do not cause SCR latch-up.

Stresses at or above those listed under Absolute Maximum Ratings may cause permanent damage to the product. This is a stress rating only; functional operation of the product at these or any other conditions above those indicated in the operational section of this specification is not implied. Operation beyond the maximum operating conditions for extended periods may affect product reliability.

ESD CAUTION



ESD (electrostatic discharge) sensitive device. Charged devices and circuit boards can discharge without detection. Although this product features patented or proprietary protection circuitry, damage may occur on devices subjected to high energy ESD. Therefore, proper ESD precautions should be taken to avoid performance degradation or loss of functionality.

PIN CONFIGURATION AND FUNCTION DESCRIPTIONS

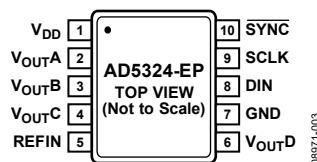

Figure 3. MSOP Pin Configuration

Table 5. Pin Function Descriptions

| Pin No. | Mnemonic | Description |
|---------|--------------------------|--|
| 1 | V _{DD} | Power Supply Input. This part can be operated from 2.5 V to 5.5 V and the supply can be decoupled to GND. |
| 2 | V _{OUTA} | Buffered Analog Output Voltage from DAC A. The output amplifier has rail-to-rail operation. |
| 3 | V _{OUTB} | Buffered Analog Output Voltage from DAC B. The output amplifier has rail-to-rail operation. |
| 4 | V _{OUTC} | Buffered Analog Output Voltage from DAC C. The output amplifier has rail-to-rail operation. |
| 5 | REFIN | Reference Input Pin for All Four DACs. It has an input range from 0.25 V to V _{DD} . |
| 6 | V _{OUTD} | Buffered Analog Output Voltage from DAC D. The output amplifier has rail-to-rail operation. |
| 7 | GND | Ground Reference Point for All Circuitry on the Part. |
| 8 | DIN | Serial Data Input. This device has a 16-bit shift register. Data is clocked into the register on the falling edge of the serial clock input. The DIN input buffer is powered down after each write cycle. |
| 9 | SCLK | Serial Clock Input. Data is clocked into the input shift register on the falling edge of the serial clock input. Data can be transferred at clock speeds up to 30 MHz. The SCLK input buffer is powered down after each write cycle. |
| 10 | $\overline{\text{SYNC}}$ | Active Low Control Input. This is the frame synchronization signal for the input data. When $\overline{\text{SYNC}}$ goes low, it enables the input shift register and data is transferred in on the falling edges of the following 16 clocks. If $\overline{\text{SYNC}}$ is taken high before the 16 th falling edge of SCLK, the rising edge of $\overline{\text{SYNC}}$ acts as an interrupt and the write sequence is ignored by the device. |

TYPICAL PERFORMANCE CHARACTERISTICS

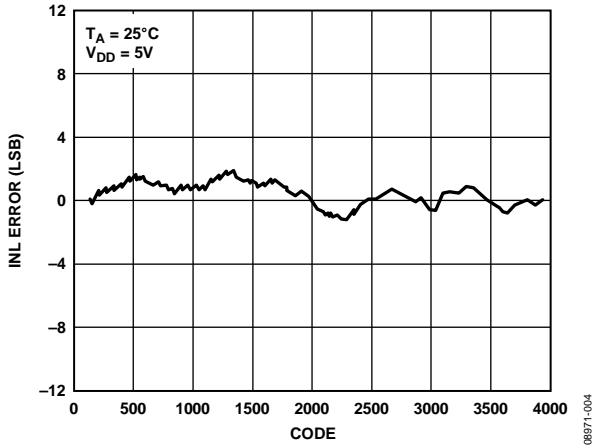

Figure 4. Typical Integral Nonlinearity (INL) Plot

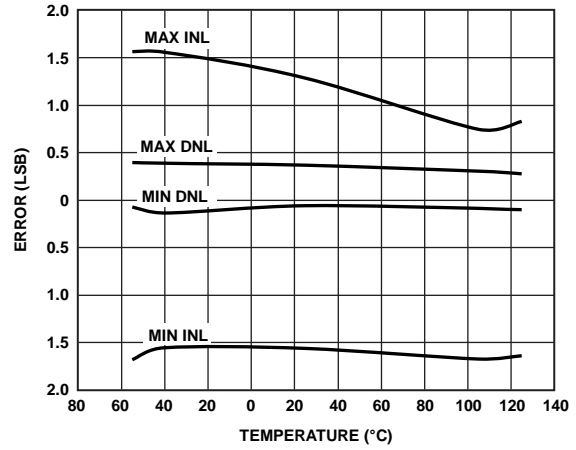

Figure 7. INL and DNL Error vs. Temperature

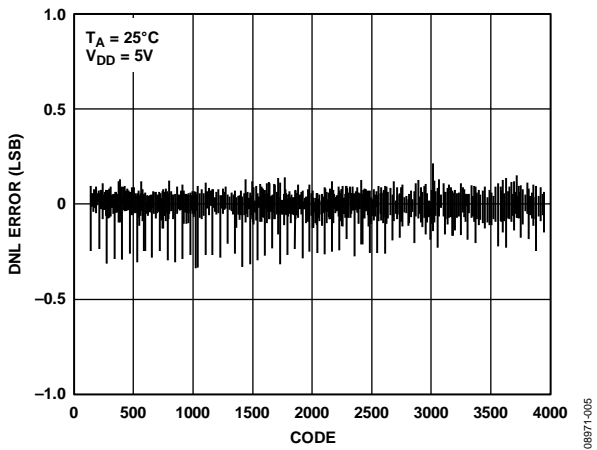

Figure 5. Typical Differential Nonlinearity (DNL) Plot

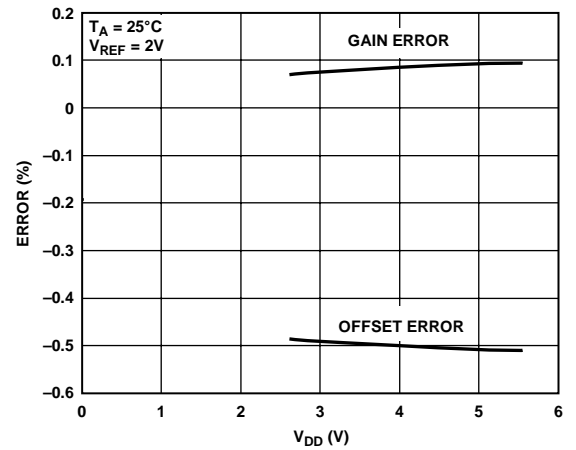

Figure 8. Offset Error and Gain Error vs. V_{DD}

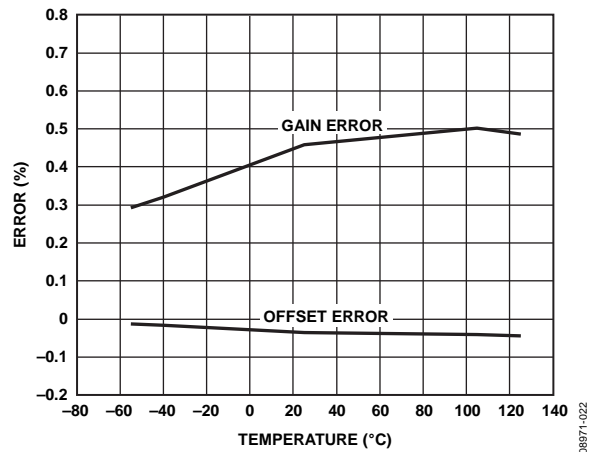

Figure 6. Offset Error and Gain Error vs. Temperature

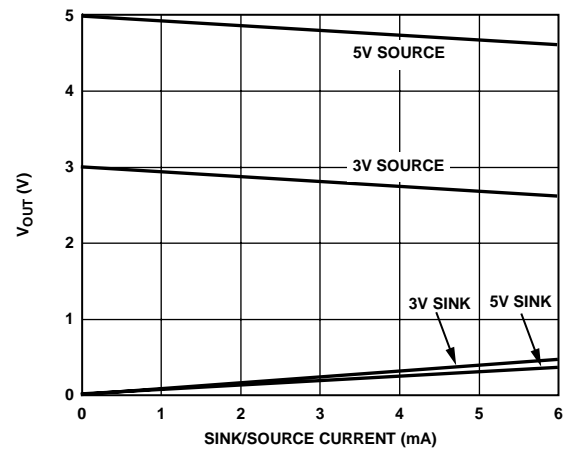

Figure 9. V_{OUT} Source and Sink Current Capability

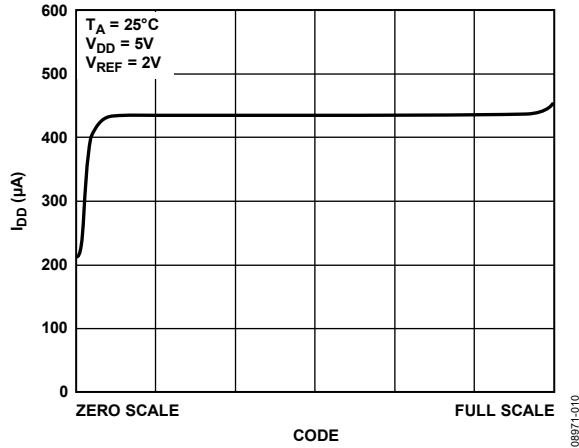

Figure 10. Supply Current vs. DAC Code

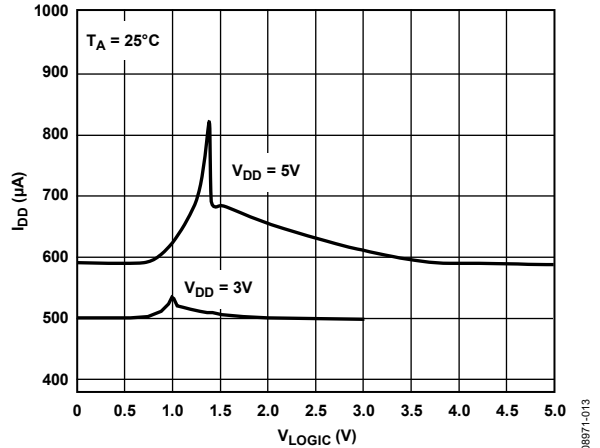

Figure 13. Supply Current vs. Logic Input Voltage

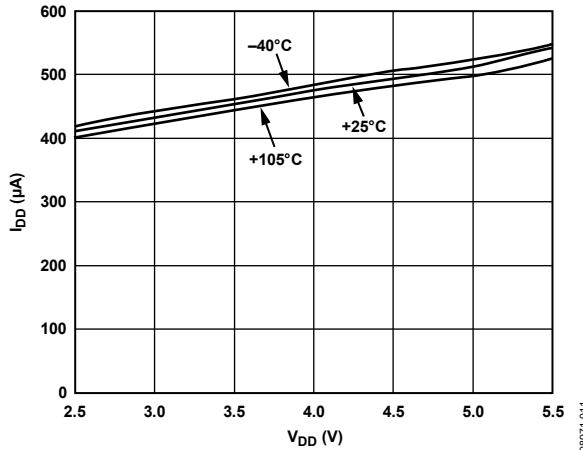

Figure 11. Supply Current vs. Supply Voltage

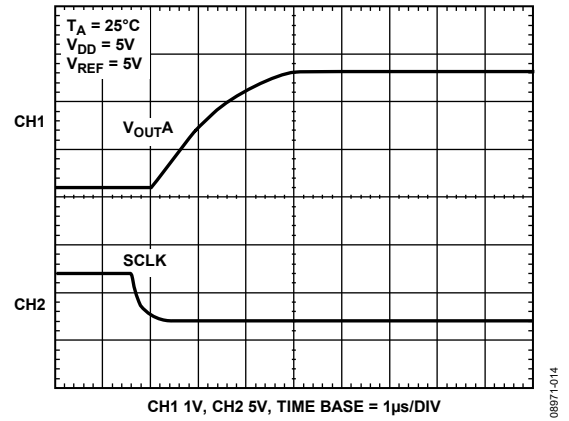

Figure 14. Half-Scale Settling (1/4 to 3/4 Scale Code Change)

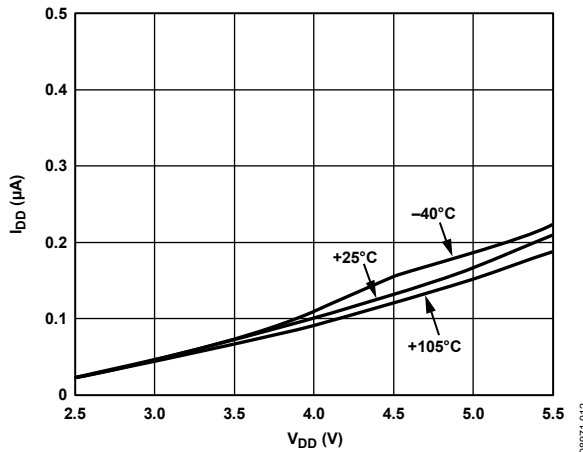

Figure 12. Power-Down Current vs. Supply Voltage

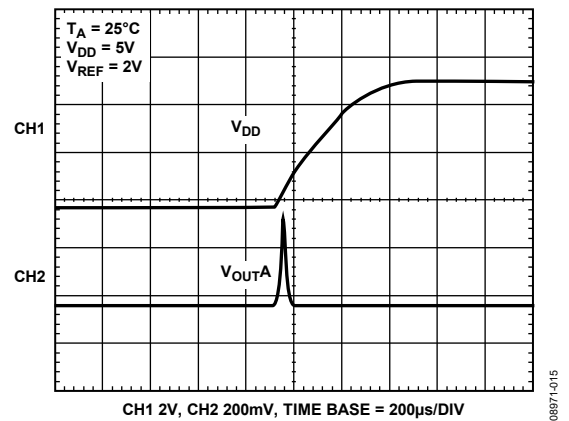

Figure 15. Power-On Reset to 0V

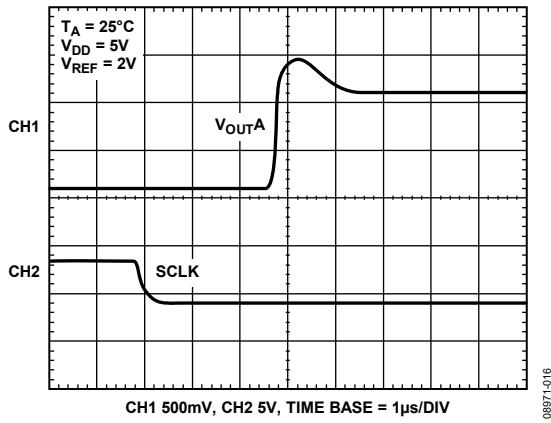

Figure 16. Exiting Power-Down to Midscale

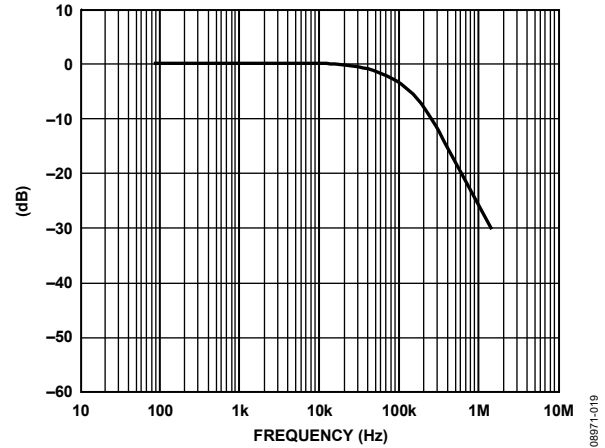

Figure 19. Multiplying Bandwidth (Small-Signal Frequency Response)

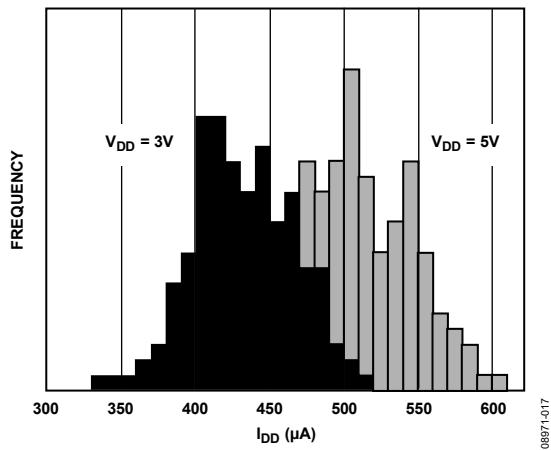

Figure 17. I_{DD} Histogram with V_{DD} = 3V and V_{DD} = 5V

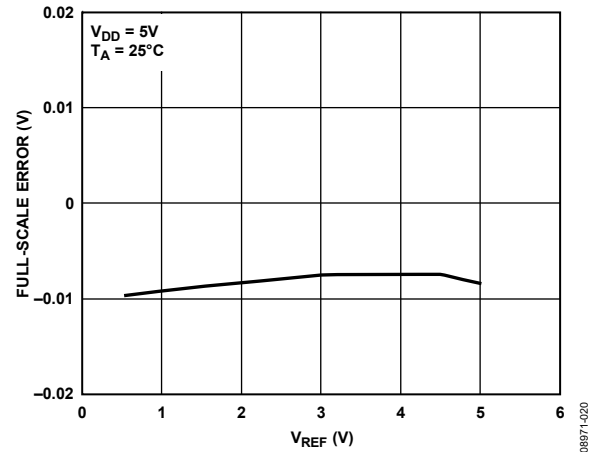

Figure 20. Full-Scale Error vs. V_{REF}

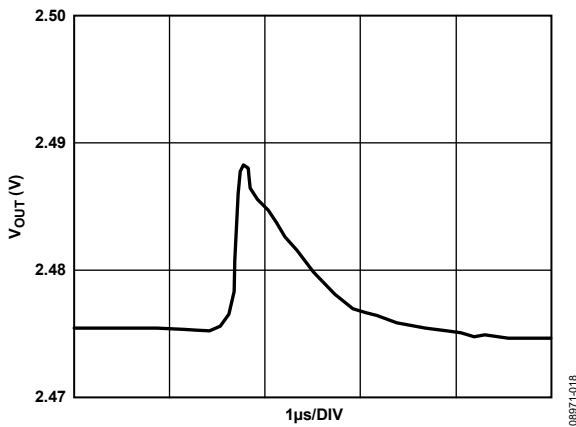

Figure 18. Major-Code Transition Glitch Energy

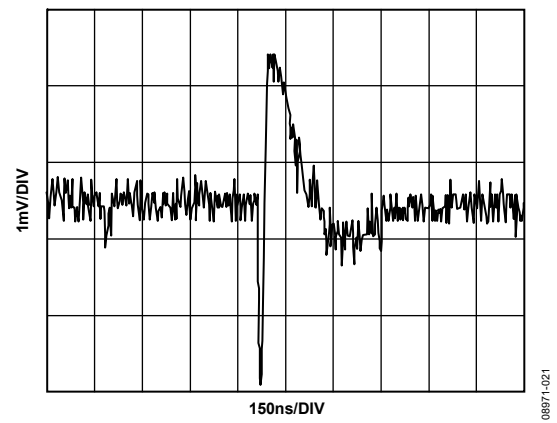
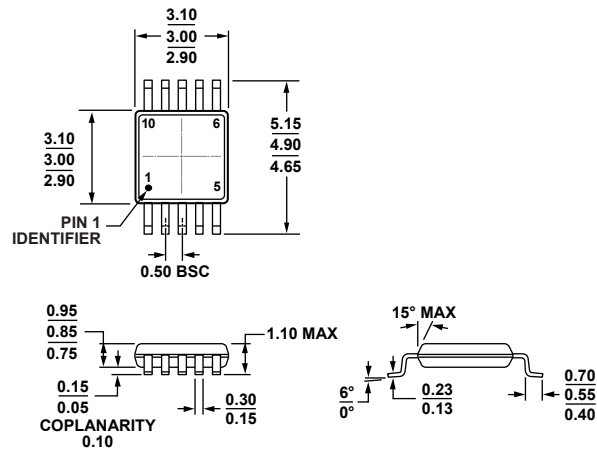

Figure 21. DAC-to-DAC Crosstalk

OUTLINE DIMENSIONS



COMPLIANT TO JEDEC STANDARDS MO-187-BA
 Figure 22. 10-Lead Mini Small Outline Package [MSOP]
 (RM-10)
 Dimensions shown in millimeters

091708-A

ORDERING GUIDE

| Model ¹ | Temperature Range | Package Description | Package Option | Marking Code |
|--------------------|-------------------|---|----------------|--------------|
| AD5324SRMZ-EP-RL7 | -55°C to +125°C | 10-Lead Mini Small Outline Package (MSOP) | RM-10 | DFT |

¹ Z = RoHS Compliant Part.