



256K x 36, 256K x 32, 512K x 18 9 Mb SYNCHRONOUS PIPELINED, SINGLE CYCLE DESELECT STATIC RAM

JANUARY 2014

FEATURES

- Internal self-timed write cycle
- Individual Byte Write Control and Global Write
- Clock controlled, registered address, data and control
- Burst sequence control using MODE input
- Three chip enable option for simple depth expansion and address pipelining
- Common data inputs and data outputs
- Auto Power-down during deselect
- Single cycle deselect
- Snooze MODE for reduced-power standby
- JTAG Boundary Scan for BGA package
- Power Supply
LPS: $V_{DD} 3.3V \pm 5\%$, $V_{DDQ} 3.3V/2.5V \pm 5\%$
VPS: $V_{DD} 2.5V \pm 5\%$, $V_{DDQ} 2.5V \pm 5\%$
- JEDEC 100-Pin QFP, 119-ball BGA, and 165-ball BGA packages
- Lead-free available

DESCRIPTION

The *ISSI* IS61LPS/VPS25636A, IS61LPS25632A, IS64LPS25636A and IS61LPS/VPS51218A are high-speed, low-power synchronous static RAMs designed to provide burstable, high-performance memory for communication and networking applications. The IS61LPS/VPS25636A and IS64LPS25636A are organized as 262,144 words by 36 bits. The IS61LPS25632A is organized as 262,144 words by 32 bits. The IS61LPS/VPS51218A is organized as 524,288 words by 18 bits. Fabricated with *ISSI*'s advanced CMOS technology, the device integrates a 2-bit burst counter, high-speed SRAM core, and high-drive capability outputs into a single monolithic circuit. All synchronous inputs pass through registers controlled by a positive-edge-triggered single clock input.

Write cycles are internally self-timed and are initiated by the rising edge of the clock input. Write cycles can be one to four bytes wide as controlled by the write control inputs.

Separate byte enables allow individual bytes to be written. The byte write operation is performed by using the byte write enable (\overline{BWE}) input combined with one or more individual byte write signals (\overline{BWx}). In addition, Global Write (\overline{GW}) is available for writing all bytes at one time, regardless of the byte write controls.

Bursts can be initiated with either \overline{ADSP} (Address Status Processor) or \overline{ADSC} (Address Status Cache Controller) input pins. Subsequent burst addresses can be generated internally and controlled by the \overline{ADV} (burst address advance) input pin.

The mode pin is used to select the burst sequence order, Linear burst is achieved when this pin is tied LOW. Interleave burst is achieved when this pin is tied HIGH or left floating.

FAST ACCESS TIME

Symbol	Parameter	250	200	166	Units
t_{kQ}	Clock Access Time	2.6	3.1	3.5	ns
t_{kC}	Cycle Time	4	5	6	ns
	Frequency	250	200	166	MHz

Copyright © 2014 Integrated Silicon Solution, Inc. All rights reserved. ISSI reserves the right to make changes to this specification and its products at any time without notice. ISSI assumes no liability arising out of the application or use of any information, products or services described herein. Customers are advised to obtain the latest version of this device specification before relying on any published information and before placing orders for products.

BLOCK DIAGRAM



165-PIN BGA

165-Ball, 13x15 mm BGA



119-PIN BGA

119-Ball, 14x22 mm BGA



119 BGA PACKAGE PIN CONFIGURATION-256K x 36 (TOP VIEW)

	1	2	3	4	5	6	7
A	V _{DDQ}	A	A	$\overline{\text{ADSP}}$	A	A	V _{DDQ}
B	NC	CE2	A	$\overline{\text{ADSC}}$	A	A	NC
C	NC	A	A	V _{DD}	A	A	NC
D	DQc	DQPc	V _{SS}	NC	V _{SS}	DQPb	DQb
E	DQc	DQc	V _{SS}	$\overline{\text{CE}}$	V _{SS}	DQb	DQb
F	V _{DDQ}	DQc	V _{SS}	$\overline{\text{OE}}$	V _{SS}	DQb	V _{DDQ}
G	DQc	DQc	$\overline{\text{BWc}}$	$\overline{\text{ADV}}$	$\overline{\text{BWb}}$	DQb	DQb
H	DQc	DQc	V _{SS}	$\overline{\text{GW}}$	V _{SS}	DQb	DQb
J	V _{DDQ}	V _{DD}	NC	V _{DD}	NC	V _{DD}	V _{DDQ}
K	DQd	DQd	V _{SS}	CLK	V _{SS}	DQa	DQa
L	DQd	DQd	$\overline{\text{BWd}}$	NC	$\overline{\text{BWa}}$	DQa	DQa
M	V _{DDQ}	DQd	V _{SS}	$\overline{\text{BWE}}$	V _{SS}	DQa	V _{DDQ}
N	DQd	DQd	V _{SS}	A ₁ *	V _{SS}	DQa	DQa
P	DQd	DQPd	V _{SS}	A ₀ *	V _{SS}	DQPa	DQa
R	NC	A	MODE	V _{DD}	NC	A	NC
T	NC	NC	A	A	A	NC	ZZ
U	V _{DDQ}	TMS	TDI	TCK	TDO	NC	V _{DDQ}

Note: * A₀ and A₁ are the two least significant bits (LSB) of the address field and set the internal burst counter if burst is desired.

PIN DESCRIPTIONS

Symbol	Pin Name
A	Address Inputs
A0, A1	Synchronous Burst Address Inputs
$\overline{\text{ADV}}$	Synchronous Burst Address Advance
$\overline{\text{ADSP}}$	Address Status Processor
$\overline{\text{ADSC}}$	Address Status Controller
$\overline{\text{GW}}$	Global Write Enable
CLK	Synchronous Clock
$\overline{\text{CE}}$, CE2	Synchronous Chip Select
$\overline{\text{BWx}}$ (x=a-d)	Synchronous Byte Write Controls
$\overline{\text{BWE}}$	Byte Write Enable

Symbol	Pin Name
$\overline{\text{OE}}$	Output Enable
ZZ	Power Sleep Mode
MODE	Burst Sequence Selection
TCK, TDO	JTAG Pins
TMS, TDI	
NC	No Connect
DQa-DQd	Data Inputs/Outputs
DQPa-Pd	Output Power Supply
V _{DD}	Power Supply
V _{DDQ}	Output Power Supply
V _{SS}	Ground

119 BGA PACKAGE PIN CONFIGURATION

512Kx18 (TOP VIEW)

	1	2	3	4	5	6	7
A	V _{DDQ}	A	A	$\overline{\text{ADSP}}$	A	A	V _{DDQ}
B	NC	CE2	A	$\overline{\text{ADSC}}$	A	A	NC
C	NC	A	A	V _{DD}	A	A	NC
D	DQb	NC	V _{SS}	NC	V _{SS}	DQPa	NC
E	NC	DQb	V _{SS}	$\overline{\text{CE}}$	V _{SS}	NC	DQa
F	V _{DDQ}	NC	V _{SS}	$\overline{\text{OE}}$	V _{SS}	DQa	V _{DDQ}
G	NC	DQb	$\overline{\text{BWB}}$	$\overline{\text{ADV}}$	V _{SS}	NC	DQa
H	DQb	NC	V _{SS}	$\overline{\text{GW}}$	V _{SS}	DQa	NC
J	V _{DDQ}	V _{DD}	NC	V _{DD}	NC	V _{DD}	V _{DDQ}
K	NC	DQb	V _{SS}	CLK	V _{SS}	NC	DQa
L	DQb	NC	V _{SS}	NC	$\overline{\text{BWA}}$	DQa	NC
M	V _{DDQ}	DQb	V _{SS}	$\overline{\text{BWE}}$	V _{SS}	NC	V _{DDQ}
N	DQb	NC	V _{SS}	A ₁ *	V _{SS}	DQa	NC
P	NC	DQPb	V _{SS}	A ₀ *	V _{SS}	NC	DQa
R	NC	A	MODE	V _{DD}	NC	A	NC
T	NC	A	A	NC	A	A	ZZ
U	V _{DDQ}	TMS	TDI	TCK	TDO	NC	V _{DDQ}

Note: * A₀ and A₁ are the two least significant bits (LSB) of the address field and set the internal burst counter if burst is desired.

PIN DESCRIPTIONS

Symbol	Pin Name
A	Address Inputs
A ₀ , A ₁	Synchronous Burst Address Inputs
$\overline{\text{ADV}}$	Synchronous Burst Address Advance
$\overline{\text{ADSP}}$	Address Status Processor
$\overline{\text{ADSC}}$	Address Status Controller
$\overline{\text{GW}}$	Global Write Enable
CLK	Synchronous Clock
$\overline{\text{CE}}$, CE2	Synchronous Chip Select
$\overline{\text{BW}}_x$ (x=a,b)	Synchronous Byte Write Controls
$\overline{\text{BWE}}$	Byte Write Enable

Symbol	Pin Name
$\overline{\text{OE}}$	Output Enable
ZZ	Power Sleep Mode
MODE	Burst Sequence Selection
TCK, TDO	JTAG Pins
TMS, TDI	
NC	No Connect
DQa-DQb	Data Inputs/Outputs
DQPa-Pb	Output Power Supply
V _{DD}	Power Supply
V _{DDQ}	Output Power Supply
V _{SS}	Ground

165 BGA PACKAGE PIN CONFIGURATION

256K x 36 (TOP VIEW)

	1	2	3	4	5	6	7	8	9	10	11
A	NC	A	\overline{CE}	\overline{BWc}	\overline{BWb}	$\overline{CE2}$	\overline{BWE}	\overline{ADSC}	\overline{ADV}	A	NC
B	NC	A	CE2	\overline{BWd}	\overline{BWA}	CLK	\overline{GW}	\overline{OE}	\overline{ADSP}	A	NC
C	DQPc	NC	VDDQ	VSS	VSS	VSS	VSS	VSS	VDDQ	NC	DQPb
D	DQc	DQc	VDDQ	VDD	VSS	VSS	VSS	VDD	VDDQ	DQb	DQb
E	DQc	DQc	VDDQ	VDD	VSS	VSS	VSS	VDD	VDDQ	DQb	DQb
F	DQc	DQc	VDDQ	VDD	VSS	VSS	VSS	VDD	VDDQ	DQb	DQb
G	DQc	DQc	VDDQ	VDD	VSS	VSS	VSS	VDD	VDDQ	DQb	DQb
H	NC	VSS	NC	VDD	VSS	VSS	VSS	VDD	NC	NC	ZZ
J	DQd	DQd	VDDQ	VDD	VSS	VSS	VSS	VDD	VDDQ	DQa	DQa
K	DQd	DQd	VDDQ	VDD	VSS	VSS	VSS	VDD	VDDQ	DQa	DQa
L	DQd	DQd	VDDQ	VDD	VSS	VSS	VSS	VDD	VDDQ	DQa	DQa
M	DQd	DQd	VDDQ	VDD	VSS	VSS	VSS	VDD	VDDQ	DQa	DQa
N	DQPd	NC	VDDQ	VSS	NC	NC	NC	VSS	VDDQ	NC	DQPd
P	NC	NC	A	A	TDI	A1*	TDO	A	A	A	A
R	MODE	NC	A	A	TMS	A0*	TCK	A	A	A	A

Note: * A0 and A1 are the two least significant bits (LSB) of the address field and set the internal burst counter if burst is desired.

PIN DESCRIPTIONS

Symbol	Pin Name
A	Address Inputs
A0, A1	Synchronous Burst Address Inputs
\overline{ADV}	Synchronous Burst Address Advance
\overline{ADSP}	Address Status Processor
\overline{ADSC}	Address Status Controller
\overline{GW}	Global Write Enable
CLK	Synchronous Clock
\overline{CE} , $\overline{CE2}$, CE2	Synchronous Chip Select
\overline{BWx} (x=a,b,c,d)	Synchronous Byte Write Controls

Symbol	Pin Name
\overline{BWE}	Byte Write Enable
\overline{OE}	Output Enable
ZZ	Power Sleep Mode
MODE	Burst Sequence Selection
TCK, TDO TMS, TDI	JTAG Pins
NC	No Connect
DQx	Data Inputs/Outputs
DQPx	Data Inputs/Outputs
VDD	3.3V/2.5V Power Supply
VDDQ	Isolated Output Power Supply 3.3V/2.5V
VSS	Ground

165 BGA PACKAGE PIN CONFIGURATION

512K x 18 (TOP VIEW)

	1	2	3	4	5	6	7	8	9	10	11
A	NC	A	\overline{CE}	\overline{BWb}	NC	$\overline{CE2}$	\overline{BWE}	\overline{ADSC}	\overline{ADV}	A	A
B	NC	A	CE2	NC	\overline{BWa}	CLK	\overline{GW}	\overline{OE}	\overline{ADSP}	A	NC
C	NC	NC	V _{DDQ}	V _{SS}	V _{SS}	V _{SS}	V _{SS}	V _{SS}	V _{DDQ}	NC	DQP _a
D	NC	DQ _b	V _{DDQ}	V _{DD}	V _{SS}	V _{SS}	V _{SS}	V _{DD}	V _{DDQ}	NC	DQ _a
E	NC	DQ _b	V _{DDQ}	V _{DD}	V _{SS}	V _{SS}	V _{SS}	V _{DD}	V _{DDQ}	NC	DQ _a
F	NC	DQ _b	V _{DDQ}	V _{DD}	V _{SS}	V _{SS}	V _{SS}	V _{DD}	V _{DDQ}	NC	DQ _a
G	NC	DQ _b	V _{DDQ}	V _{DD}	V _{SS}	V _{SS}	V _{SS}	V _{DD}	V _{DDQ}	NC	DQ _a
H	NC	V _{SS}	NC	V _{DD}	V _{SS}	V _{SS}	V _{SS}	V _{DD}	NC	NC	ZZ
J	DQ _b	NC	V _{DDQ}	V _{DD}	V _{SS}	V _{SS}	V _{SS}	V _{DD}	V _{DDQ}	DQ _a	NC
K	DQ _b	NC	V _{DDQ}	V _{DD}	V _{SS}	V _{SS}	V _{SS}	V _{DD}	V _{DDQ}	DQ _a	NC
L	DQ _b	NC	V _{DDQ}	V _{DD}	V _{SS}	V _{SS}	V _{SS}	V _{DD}	V _{DDQ}	DQ _a	NC
M	DQ _b	NC	V _{DDQ}	V _{DD}	V _{SS}	V _{SS}	V _{SS}	V _{DD}	V _{DDQ}	DQ _a	NC
N	DQP _b	NC	V _{DDQ}	V _{SS}	NC	NC	NC	V _{SS}	V _{DDQ}	NC	NC
P	NC	NC	A	A	TDI	A1*	TDO	A	A	A	A
R	MODE	NC	A	A	TMS	A0*	TCK	A	A	A	A

Note: * A₀ and A₁ are the two least significant bits (LSB) of the address field and set the internal burst counter if burst is desired.

PIN DESCRIPTIONS

Symbol	Pin Name
A	Address Inputs
A ₀ , A ₁	Synchronous Burst Address Inputs
\overline{ADV}	Synchronous Burst Address Advance
\overline{ADSP}	Address Status Processor
\overline{ADSC}	Address Status Controller
\overline{GW}	Global Write Enable
CLK	Synchronous Clock
\overline{CE} , $\overline{CE2}$, CE2	Synchronous Chip Select
\overline{BWx} (x=a,b)	Synchronous Byte Write Controls

Symbol	Pin Name
\overline{BWE}	Byte Write Enable
\overline{OE}	Output Enable
ZZ	Power Sleep Mode
MODE	Burst Sequence Selection
TCK, TDO TMS, TDI	JTAG Pins
NC	No Connect
DQ _x	Data Inputs/Outputs
DQP _x	Data Inputs/Outputs
V _{DD}	3.3V/2.5V Power Supply
V _{DDQ}	Isolated Output Power Supply 3.3V/2.5V
V _{SS}	Ground

PIN CONFIGURATION

100-PIN QFP (256K X 36)

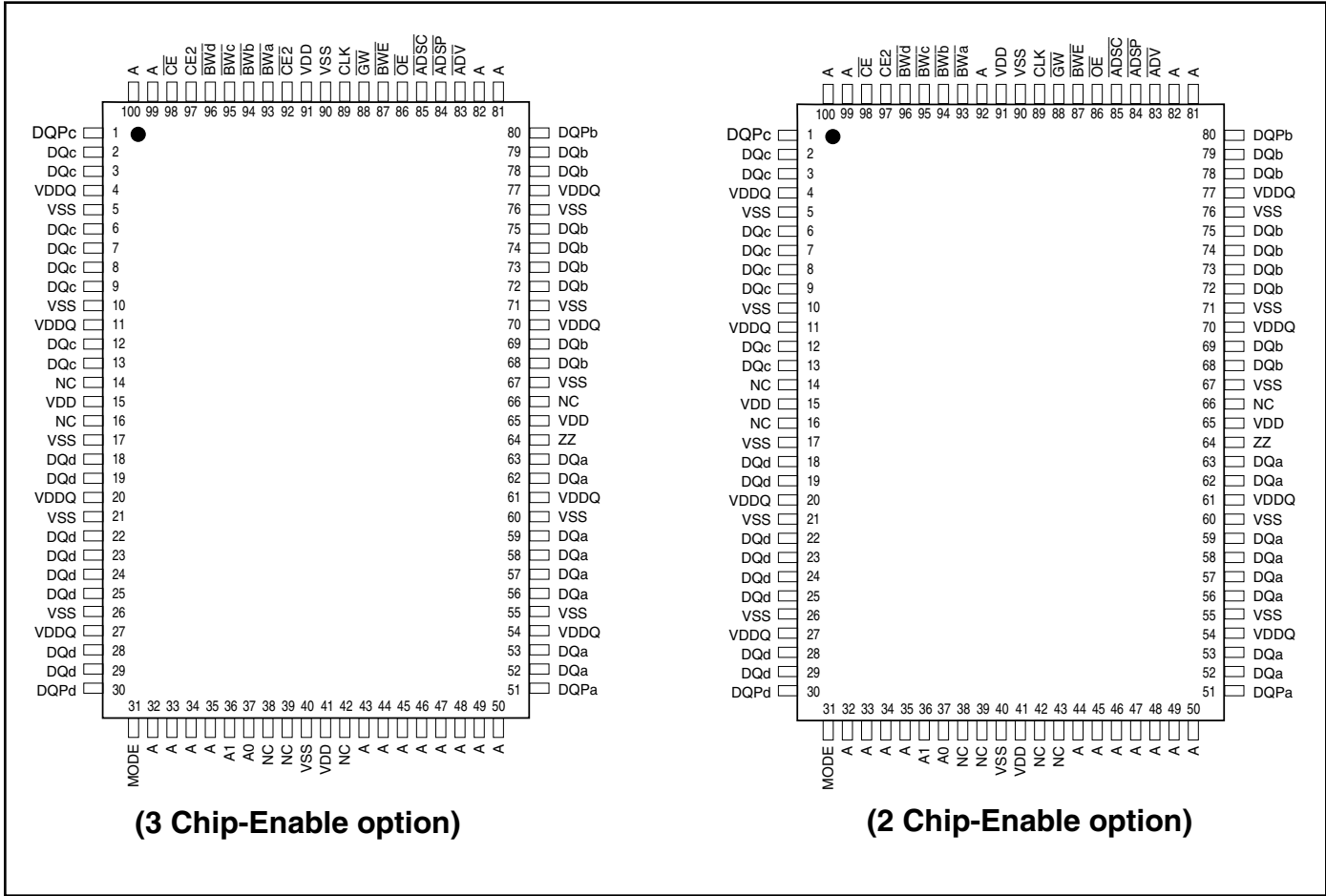

PIN DESCRIPTIONS

A0, A1	Synchronous Address Inputs. These pins must tied to the two LSBs of the address bus.
A	Synchronous Address Inputs
ADSC	Synchronous Controller Address Status
ADSP	Synchronous Processor Address Status
ADV	Synchronous Burst Address Advance
BW \bar{a} -BW \bar{d}	Synchronous Byte Write Enable
BWE	Synchronous Byte Write Enable
CE, CE2, CE2	Synchronous Chip Enable
CLK	Synchronous Clock

DQa-DQd	Synchronous Data Input/Output
DQPa-DQPd	Parity Data Input/Output
\overline{GW}	Synchronous Global Write Enable
MODE	Burst Sequence Mode Selection
\overline{OE}	Output Enable
VDD	3.3V/2.5V Power Supply
VDDQ	Isolated Output Buffer Supply: 3.3V/2.5V
VSS	Ground
ZZ	Snooze Enable

PIN CONFIGURATION

100-PIN QFP (256K X 32)

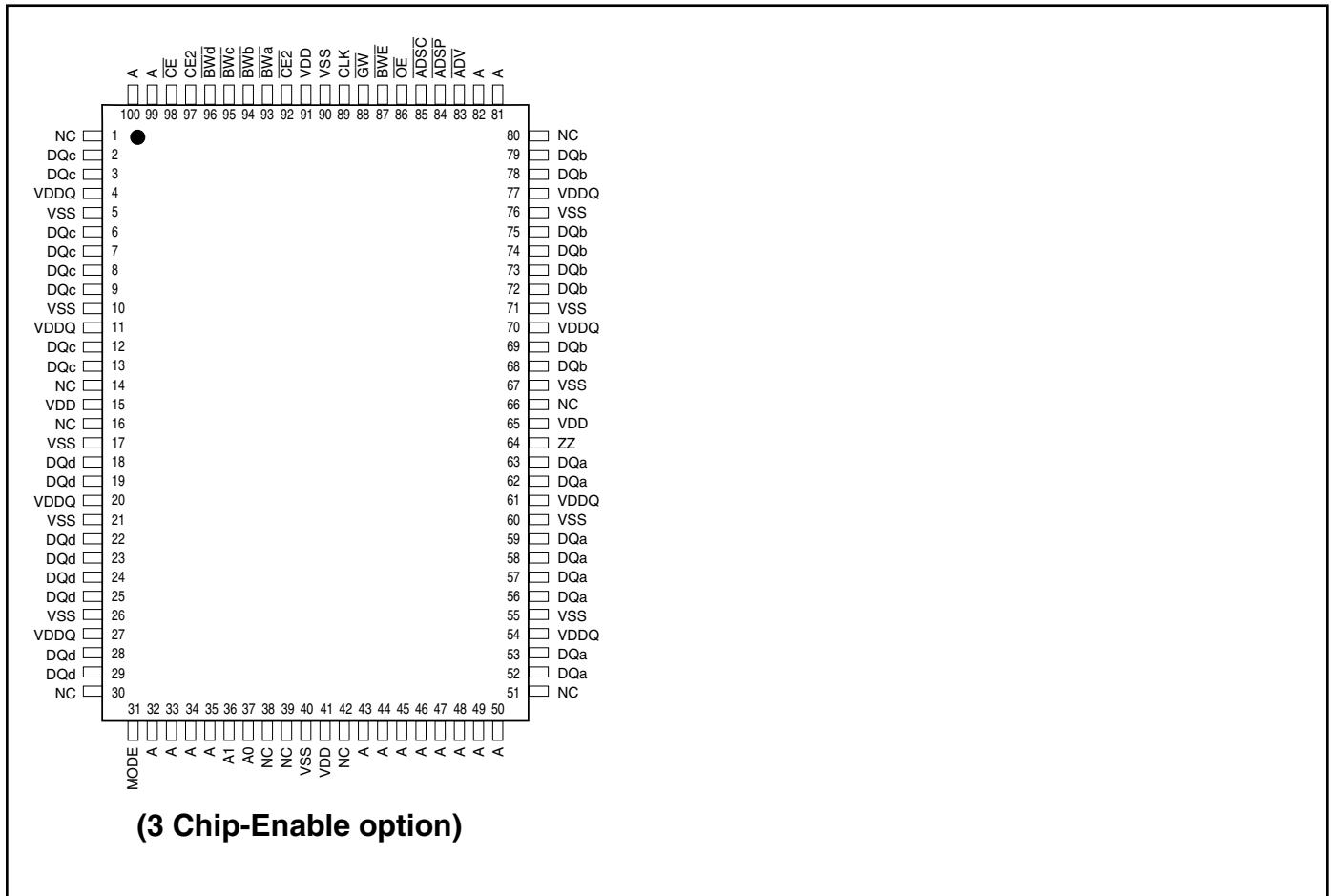

PIN DESCRIPTIONS

A0, A1	Synchronous Address Inputs. These pins must tied to the two LSBs of the address bus.	DQa-DQd	Synchronous Data Input/Output
A	Synchronous Address Inputs	\overline{GW}	Synchronous Global Write Enable
\overline{ADSC}	Synchronous Controller Address Status	MODE	Burst Sequence Mode Selection
\overline{ADSP}	Synchronous Processor Address Status	\overline{OE}	Output Enable
\overline{ADV}	Synchronous Burst Address Advance	V _{DD}	3.3V/2.5V Power Supply
\overline{BWA} - \overline{BWD}	Synchronous Byte Write Enable	V _{DDQ}	Isolated Output Buffer Supply: 3.3V/2.5V
\overline{BWE}	Synchronous Byte Write Enable	V _{SS}	Ground
\overline{CE} , $\overline{CE2}$, CE2	Synchronous Chip Enable	ZZ	Snooze Enable
CLK	Synchronous Clock		

PIN CONFIGURATION

100-PIN QFP (512K X 18)

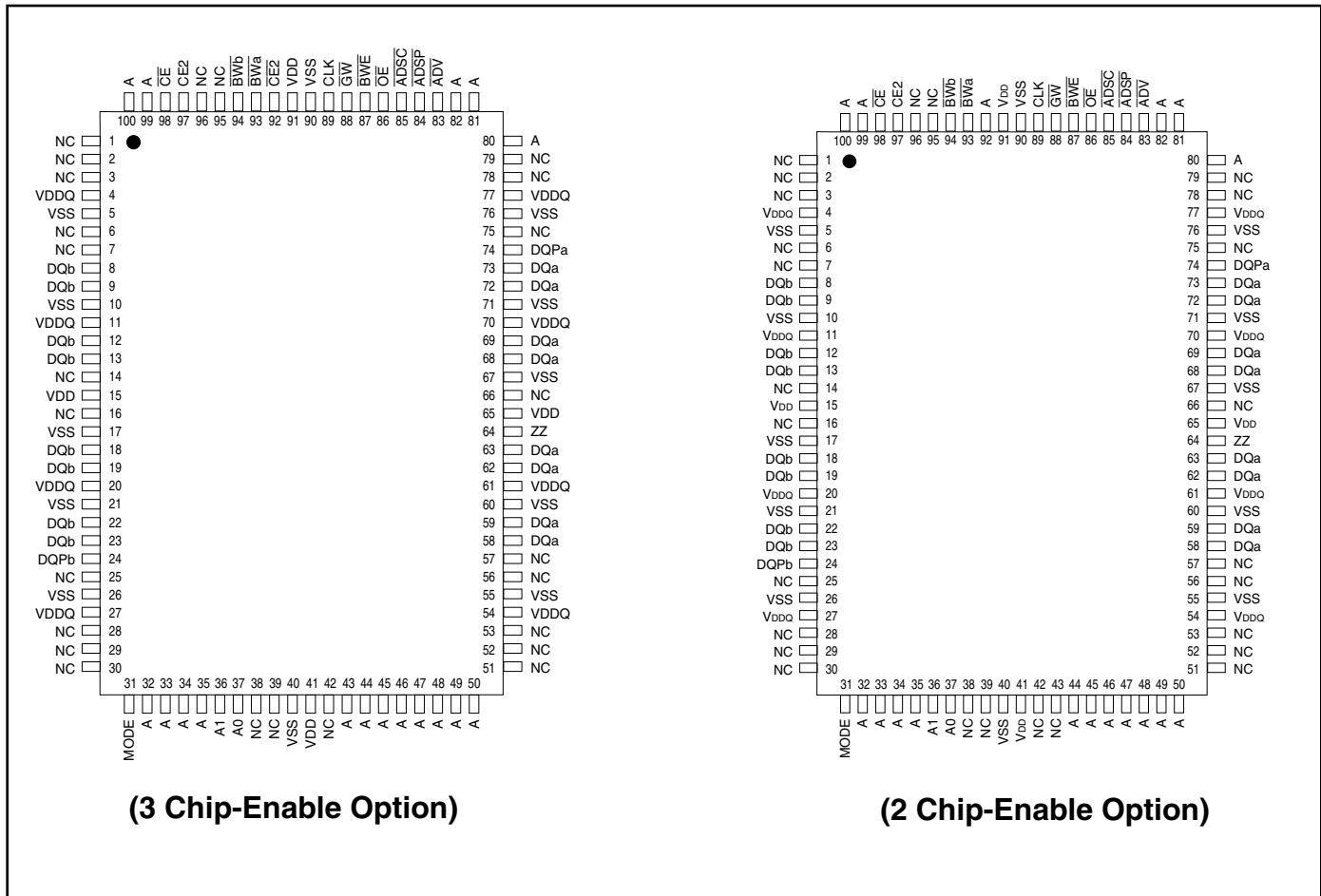

PIN DESCRIPTIONS

A0, A1	Synchronous Address Inputs. These pins must tied to the two LSBs of the address bus.	DQPa-DQPb	Parity Data I/O; DQPa is parity for DQa1-8; DQPb is parity for DQb1-8
A	Synchronous Address Inputs	\overline{GW}	Synchronous Global Write Enable
\overline{ADSC}	Synchronous Controller Address Status	MODE	Burst Sequence Mode Selection
\overline{ADSP}	Synchronous Processor Address Status	\overline{OE}	Output Enable
\overline{ADV}	Synchronous Burst Address Advance	V _{DD}	3.3V/2.5V Power Supply
\overline{BWa} - \overline{BWb}	Synchronous Byte Write Enable	V _{DDQ}	Isolated Output Buffer Supply: 3.3V/2.5V
\overline{BWE}	Synchronous Byte Write Enable	V _{SS}	Ground
\overline{CE} , $\overline{CE2}$, $\overline{CE2}$	Synchronous Chip Enable	\overline{ZZ}	Snooze Enable
CLK	Synchronous Clock		
DQa-DQb	Synchronous Data Input/Output		

**IS61LPS51218A, IS61LPS25636A, IS61LPS25632A, IS64LPS25636A,
IS61VPS51218A, IS61VPS25636A**

TRUTH TABLE⁽¹⁻⁸⁾

OPERATION	ADDRESS	CE	CE2	CE2	ZZ	ADSP	ADSC	ADV	WRITE	OE	CLK	DQ
Deselect Cycle, Power-Down	None	H	X	X	L	X	L	X	X	X	L-H	High-Z
Deselect Cycle, Power-Down	None	L	X	L	L	L	X	X	X	X	L-H	High-Z
Deselect Cycle, Power-Down	None	L	H	X	L	L	X	X	X	X	L-H	High-Z
Deselect Cycle, Power-Down	None	L	X	L	L	H	L	X	X	X	L-H	High-Z
Deselect Cycle, Power-Down	None	L	H	X	L	H	L	X	X	X	L-H	High-Z
Snooze Mode, Power-Down	None	X	X	X	H	X	X	X	X	X	X	High-Z
Read Cycle, Begin Burst	External	L	L	H	L	L	X	X	X	L	L-H	Q
Read Cycle, Begin Burst	External	L	L	H	L	L	X	X	X	H	L-H	High-Z
Write Cycle, Begin Burst	External	L	L	H	L	H	L	X	L	X	L-H	D
Read Cycle, Begin Burst	External	L	L	H	L	H	L	X	H	L	L-H	Q
Read Cycle, Begin Burst	External	L	L	H	L	H	L	X	H	H	L-H	High-Z
Read Cycle, Continue Burst	Next	X	X	X	L	H	H	L	H	L	L-H	Q
Read Cycle, Continue Burst	Next	X	X	X	L	H	H	L	H	H	L-H	High-Z
Read Cycle, Continue Burst	Next	H	X	X	L	X	H	L	H	L	L-H	Q
Read Cycle, Continue Burst	Next	H	X	X	L	X	H	L	H	H	L-H	High-Z
Write Cycle, Continue Burst	Next	X	X	X	L	H	H	L	L	X	L-H	D
Write Cycle, Continue Burst	Next	H	X	X	L	X	H	L	L	X	L-H	D
Read Cycle, Suspend Burst	Current	X	X	X	L	H	H	H	H	L	L-H	Q
Read Cycle, Suspend Burst	Current	X	X	X	L	H	H	H	H	H	L-H	High-Z
Read Cycle, Suspend Burst	Current	H	X	X	L	X	H	H	H	L	L-H	Q
Read Cycle, Suspend Burst	Current	H	X	X	L	X	H	H	H	H	L-H	High-Z
Write Cycle, Suspend Burst	Current	X	X	X	L	H	H	H	L	X	L-H	D
Write Cycle, Suspend Burst	Current	H	X	X	L	X	H	H	L	X	L-H	D

NOTE:

1. X means "Don't Care." H means logic HIGH. L means logic LOW.
2. For \overline{WRITE} , L means one or more byte write enable signals ($\overline{BWA-d}$) and \overline{BWE} are LOW or \overline{GW} is LOW. $\overline{WRITE} = H$ for all \overline{BWx} , \overline{BWE} , \overline{GW} HIGH.
3. \overline{BWA} enables WRITES to DQa's and DQPc. \overline{BWB} enables WRITES to DQb's and DQPb. \overline{BWC} enables WRITES to DQc's and DQPc. \overline{BWD} enables WRITES to DQd's and DQPd. DQPc and DQPd are available on the x18 version. DQPc-DQPd are available on the x36 version.
4. All inputs except \overline{OE} and ZZ must meet setup and hold times around the rising edge (LOW to HIGH) of CLK.
5. Wait states are inserted by suspending burst.
6. For a WRITE operation following a READ operation, \overline{OE} must be HIGH before the input data setup time and held HIGH during the input data hold time.
7. This device contains circuitry that will ensure the outputs will be in High-Z during power-up.
8. ADSP LOW always initiates an internal READ at the L-H edge of CLK. A WRITE is performed by setting one or more byte write enable signals and \overline{BWE} LOW or \overline{GW} LOW for the subsequent L-H edge of CLK. See WRITE timing diagram for clarification.

PARTIAL TRUTH TABLE

Function	\overline{GW}	\overline{BWE}	\overline{BWA}	\overline{BWB}	\overline{BWC}	\overline{BWD}
Read	H	H	X	X	X	X
Read	H	L	H	H	H	H
Write Byte 1	H	L	L	H	H	H
Write All Bytes	H	L	L	L	L	L
Write All Bytes	L	X	X	X	X	X

INTERLEAVED BURST ADDRESS TABLE (MODE = V_{DD} or No Connect)

External Address	1st Burst Address	2nd Burst Address	3rd Burst Address
A1 A0	A1 A0	A1 A0	A1 A0
00	01	10	11
01	00	11	10
10	11	00	01
11	10	01	00

LINEAR BURST ADDRESS TABLE (MODE = V_{SS})



ABSOLUTE MAXIMUM RATINGS⁽¹⁾

Symbol	Parameter	Value	Unit
T _{STG}	Storage Temperature	-55 to +150	°C
P _D	Power Dissipation	1.6	W
I _{OUT}	Output Current (per I/O)	100	mA
V _{IN} , V _{OUT}	Voltage Relative to V _{SS} for I/O Pins	-0.5 to V _{DDQ} + 0.5	V
V _{IN}	Voltage Relative to V _{SS} for for Address and Control Inputs	-0.5 to V _{DD} + 0.5	V
V _{DD}	Voltage on V _{DD} Supply Relative to V _{SS}	-0.5 to 4.6	V

Notes:

1. Stress greater than those listed under ABSOLUTE MAXIMUM RATINGS may cause permanent damage to the device. This is a stress rating only and functional operation of the device at these or any other conditions above those indicated in the operational sections of this specification is not implied. Exposure to absolute maximum rating conditions for extended periods may affect reliability.
2. This device contains circuitry to protect the inputs against damage due to high static voltages or electric fields; however, precautions may be taken to avoid application of any voltage higher than maximum rated voltages to this high-impedance circuit.
3. This device contains circuitry that will ensure the output devices are in High-Z at power up.

OPERATING RANGE (IS61LPSXXXXX)

Range	Ambient Temperature	V _{DD}	V _{DDQ}
Commercial	0°C to +70°C	3.3V ± 5%	3.3V / 2.5V ± 5%
Industrial	-40°C to +85°C	3.3V ± 5%	3.3V / 2.5V ± 5%

OPERATING RANGE (IS61VPSXXXXX)

Range	Ambient Temperature	V _{DD}	V _{DDQ}
Commercial	0°C to +70°C	2.5V ± 5%	2.5V ± 5%
Industrial	-40°C to +85°C	2.5V ± 5%	2.5V ± 5%

OPERATING RANGE (IS64LPSXXXXX)

Range	Ambient Temperature	V _{DD}	V _{DDQ}
Automotive	-40°C to +125°C	3.3V ± 5%	3.3V / 2.5V ± 5%

DC ELECTRICAL CHARACTERISTICS (Over Operating Range)

Symbol	Parameter	Test Conditions	3.3V		2.5V		Unit
			Min.	Max.	Min.	Max.	
V _{OH}	Output HIGH Voltage	I _{OH} = -4.0 mA (3.3V) I _{OH} = -1.0 mA (2.5V)	2.4	—	2.0	—	V
V _{OL}	Output LOW Voltage	I _{OL} = 8.0 mA (3.3V) I _{OL} = 1.0 mA (2.5V)	—	0.4	—	0.4	V
V _{IH}	Input HIGH Voltage		2.0	V _{DD} + 0.3	1.7	V _{DD} + 0.3	V
V _{IL}	Input LOW Voltage		-0.3	0.8	-0.3	0.7	V
I _{LI}	Input Leakage Current	V _{SS} ≤ V _{IN} ≤ V _{DD} ⁽¹⁾	-5	5	-5	5	μA
I _{LO}	Output Leakage Current	V _{SS} ≤ V _{OUT} ≤ V _{DDQ} , OE = V _{IH}	-5	5	-5	5	μA

POWER SUPPLY CHARACTERISTICS⁽¹⁾ (Over Operating Range)

Symbol	Parameter	Test Conditions	Temp. range	-250 MAX		-200 MAX		-166 MAX		Unit
				x18	x36	x18	x36	x18	x36	
I _{CC}	AC Operating Supply Current	Device Selected, $\overline{OE} = V_{IH}$, $ZZ \leq V_{IL}$, All Inputs $\leq 0.2V$ or $\geq V_{DD} - 0.2V$, Cycle Time $\geq t_{kc}$ min.	Com.	275	275	250	250	225	225	mA
			Ind.	300	300	275	275	250	250	
			Auto.					300	300	
I _{SB}	Standby Current TTL Input	Device Deselected, $V_{DD} = \text{Max.}$, All Inputs $\leq V_{IL}$ or $\geq V_{IH}$, $ZZ \leq V_{IL}$, $f = \text{Max.}$	Com.	150	150	150	150	150	150	mA
			Ind.	150	150	150	150	150	150	
			AUTO.					200	200	
I _{SBI}	Standby Current CMOS Input	Device Deselected, $V_{DD} = \text{Max.}$, $V_{IN} \leq V_{SS} + 0.2V$ or $\geq V_{DD} - 0.2V$ $f = 0$	Com.	100	100	100	100	100	100	mA
			Ind.	105	105	105	105	105	105	
			Auto.					130	130	

Note:

1. MODE pin has an internal pullup and should be tied to V_{DD} or V_{SS} . It exhibits $\pm 100\mu A$ maximum leakage current when tied to $\leq V_{SS} + 0.2V$ or $\geq V_{DD} - 0.2V$.

CAPACITANCE^(1,2)

Symbol	Parameter	Conditions	Max.	Unit
C _{IN}	Input Capacitance	V _{IN} = 0V	6	pF
C _{OUT}	Input/Output Capacitance	V _{OUT} = 0V	8	pF

Notes:

1. Tested initially and after any design or process changes that may affect these parameters.
2. Test conditions: T_A = 25°C, f = 1 MHz, V_{DD} = 3.3V.

3.3V I/O AC TEST CONDITIONS

Parameter	Unit
Input Pulse Level	0V to 3.0V
Input Rise and Fall Times	1.5 ns
Input and Output Timing and Reference Level	1.5V
Output Load	See Figures 1 and 2

AC TEST LOADS

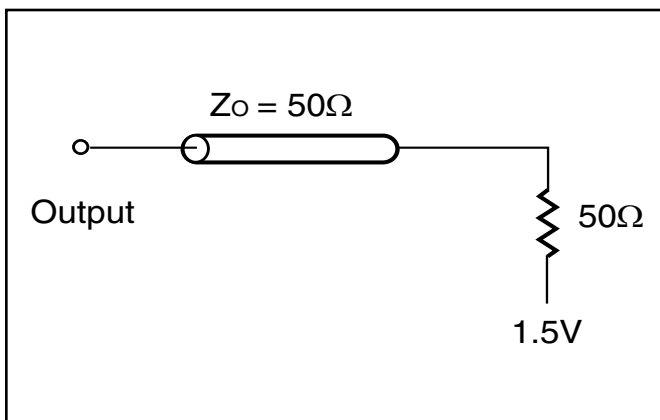

Figure 1



Figure 2

2.5V I/O AC TEST CONDITIONS

Parameter	Unit
Input Pulse Level	0V to 2.5V
Input Rise and Fall Times	1.5 ns
Input and Output Timing and Reference Level	1.25V
Output Load	See Figures 3 and 4

2.5 I/O OUTPUT LOAD EQUIVALENT

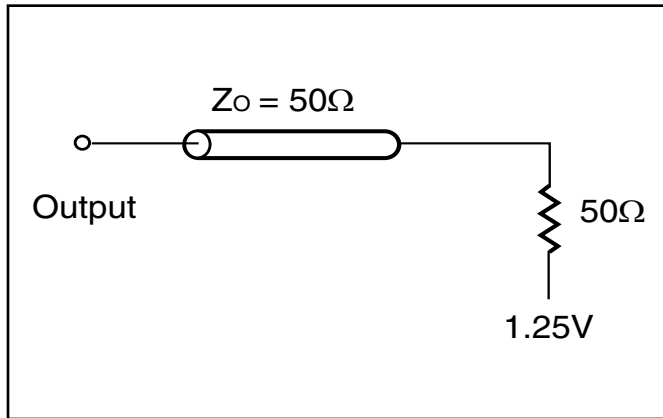

Figure 3

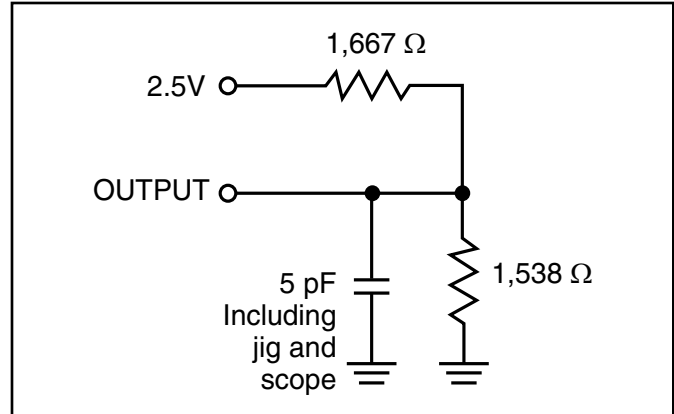

Figure 4



READ/WRITE CYCLE SWITCHING CHARACTERISTICS (Over Operating Range)

Symbol	Parameter	-250		-200		-166		Unit
		Min.	Max.	Min.	Max.	Min.	Max.	
f _{MAX}	Clock Frequency	—	250	—	200	—	166	MHz
t _{KC}	Cycle Time	4.0	—	5	—	6	—	ns
t _{KH}	Clock High Time	1.7	—	2	—	2.4	—	ns
t _{KL}	Clock Low Time	1.7	—	2	—	2.3	—	ns
t _{KQ}	Clock Access Time	—	2.6	—	3.1	—	3.8	ns
t _{KQX} ⁽²⁾	Clock High to Output Invalid	0.8	—	1.5	—	1.5	—	ns
t _{KQLZ} ^(2,3)	Clock High to Output Low-Z	0.8	—	1	—	1.5	—	ns
t _{KQHZ} ^(2,3)	Clock High to Output High-Z	—	2.6	—	3.0	3.5	—	ns
t _{OEQ}	Output Enable to Output Valid	—	2.6	—	3.1	3.5	—	ns
t _{OELZ} ^(2,3)	Output Enable to Output Low-Z	0	—	0	—	0	—	ns
t _{OEHZ} ^(2,3)	Output Disable to Output High-Z	—	2.6	—	3.0	3.5	—	ns
t _{AS}	Address Setup Time	1.2	—	1.4	—	1.7	—	ns
t _{WS}	Read/Write Setup Time	1.2	—	1.4	—	1.7	—	ns
t _{CES}	Chip Enable Setup Time	1.2	—	1.4	—	1.7	—	ns
t _{AVS}	Address Advance Setup Time	1.2	—	1.4	—	1.7	—	ns
t _{DS}	Data Setup Time	1.2	—	1.4	—	1.7	—	ns
t _{AH}	Address Hold Time	0.3	—	0.4	—	0.7	—	ns
t _{WH}	Write Hold Time	0.3	—	0.4	—	0.7	—	ns
t _{CEH}	Chip Enable Hold Time	0.3	—	0.4	—	0.7	—	ns
t _{AVH}	Address Advance Hold Time	0.3	—	0.4	—	0.7	—	ns
t _{DH}	Data Hold Time	0.3	—	0.4	—	0.7	—	ns
t _{PDS}	ZZ High to Power Down	—	2	—	2	—	2	cyc
t _{PUS}	ZZ Low to Power Down	—	2	—	2	—	2	cyc

Note:

1. Configuration signal MODE is static and must not change during normal operation.
2. Guaranteed but not 100% tested. This parameter is periodically sampled.
3. Tested with load in Figure 2.

READ/WRITE CYCLE TIMING

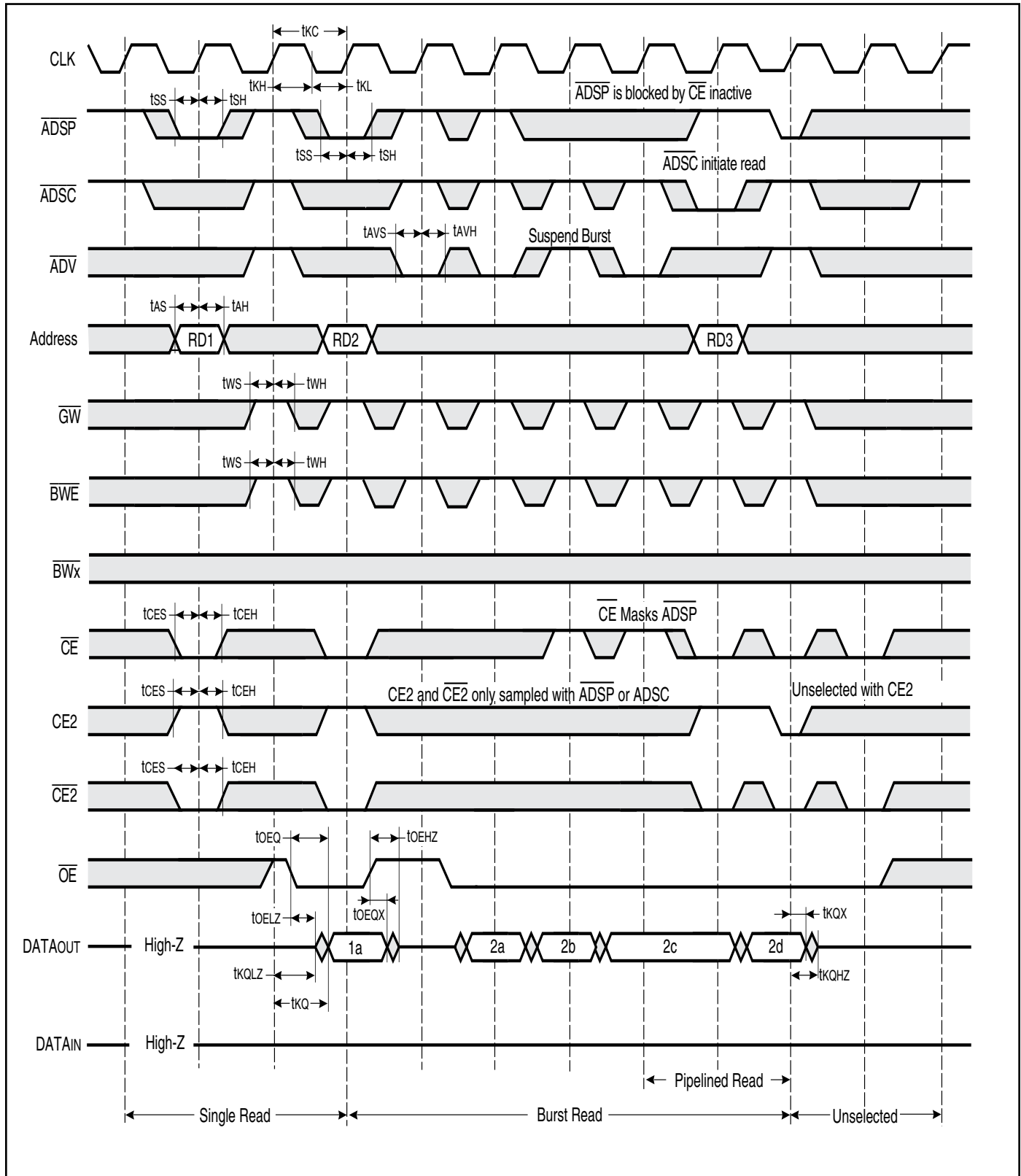

WRITE CYCLE TIMING



SNOOZE MODE ELECTRICAL CHARACTERISTICS

Symbol	Parameter	Conditions	Temperature Range	Min.	Max.	Unit
ISB2	Current during SNOOZE MODE	ZZ ≥ Vih	Com.	—	50	mA
			Ind.	—	60	
			Auto.	—	75	
tpDS	ZZ active to input ignored			—	2	cycle
tpUS	ZZ inactive to input sampled			2	—	cycle
tzzI	ZZ active to SNOOZE current			—	2	cycle
trZZI	ZZ inactive to exit SNOOZE current			0	—	ns

SNOOZE MODE TIMING



IEEE 1149.1 SERIAL BOUNDARY SCAN (JTAG)

The IS61LPS/VPSxxxxxx products have a serial boundary scan Test Access Port (TAP) in the BGA package only. (The QFP package not available.) This port operates in accordance with IEEE Standard 1149.1-1900, but does not include all functions required for full 1149.1 compliance. These functions from the IEEE specification are excluded because they place added delay in the critical speed path of the SRAM. The TAP controller operates in a manner that does not conflict with the performance of other devices using 1149.1 fully compliant TAPs. The TAP operates using JEDEC standard 2.5V I/O logic levels.

DISABLING THE JTAG FEATURE

The SRAM can operate without using the JTAG feature. To disable the TAP controller, TCK must be tied LOW (V_{SS}) to prevent clocking of the device. TDI and TMS are internally pulled up and may be disconnected. They may alternately be connected to V_{DD} through a pull-up resistor. TDO should be left disconnected. On power-up, the device will start in a reset state which will not interfere with the device operation.

TEST ACCESS PORT (TAP) - TEST CLOCK

The test clock is only used with the TAP controller. All inputs are captured on the rising edge of TCK and outputs are driven from the falling edge of TCK.

TEST MODE SELECT (TMS)

The TMS input is used to send commands to the TAP controller and is sampled on the rising edge of TCK. This pin may be left disconnected if the TAP is not used. The pin is internally pulled up, resulting in a logic HIGH level.

TEST DATA-IN (TDI)

The TDI pin is used to serially input information to the registers and can be connected to the input of any register. The register between TDI and TDO is chosen by the instruction loaded into the TAP instruction register. For information on instruction register loading, see the TAP Controller State Diagram. TDI is internally pulled up and can be disconnected if the TAP is unused in an application. TDI is connected to the Most Significant Bit (MSB) on any register.

TAP CONTROLLER BLOCK DIAGRAM





TEST DATA OUT (TDO)

The TDO output pin is used to serially clock data-out from the registers. The output is active depending on the current state of the TAP state machine (see TAP Controller State Diagram). The output changes on the falling edge of TCK and TDO is connected to the Least Significant Bit (LSB) of any register.

PERFORMING A TAP RESET

A Reset is performed by forcing TMS HIGH (V_{DD}) for five rising edges of TCK. RESET may be performed while the SRAM is operating and does not affect its operation. At power-up, the TAP is internally reset to ensure that TDO comes up in a high-Z state.

TAP REGISTERS

Registers are connected between the TDI and TDO pins and allow data to be scanned into and out of the SRAM test circuitry. Only one register can be selected at a time through the instruction registers. Data is serially loaded into the TDI pin on the rising edge of TCK and output on the TDO pin on the falling edge of TCK.

Instruction Register

Three-bit instructions can be serially loaded into the instruction register. This register is loaded when it is placed between the TDI and TDO pins. (See TAP Controller Block Diagram) At power-up, the instruction register is loaded with the IDCODE instruction. It is also loaded with the IDCODE instruction if the controller is placed in a reset state as previously described.

When the TAP controller is in the CaptureIR state, the two least significant bits are loaded with a binary “01” pattern to allow for fault isolation of the board level serial test path.

Bypass Register

To save time when serially shifting data through registers, it is sometimes advantageous to skip certain states. The bypass register is a single-bit register that can be placed between TDI and TDO pins. This allows data to be shifted through the SRAM with minimal delay. The bypass reg-

ister is set LOW (V_{SS}) when the BYPASS instruction is executed.

Boundary Scan Register

The boundary scan register is connected to all input and output pins on the SRAM. Several no connect (NC) pins are also included in the scan register to reserve pins for higher density devices. The x36 configuration has a 75-bit-long register and the x18 configuration also has a 75-bit-long register. The boundary scan register is loaded with the contents of the RAM Input and Output ring when the TAP controller is in the Capture-DR state and then placed between the TDI and TDO pins when the controller is moved to the Shift-DR state. The EXTEST, SAMPLE/PRELOAD and SAMPLE-Z instructions can be used to capture the contents of the Input and Output ring.

The Boundary Scan Order tables show the order in which the bits are connected. Each bit corresponds to one of the bumps on the SRAM package. The MSB of the register is connected to TDI, and the LSB is connected to TDO.

Scan Register Sizes

Register Name	Bit Size (x18)	Bit Size (x36)
Instruction	3	3
Bypass	1	1
ID	32	32
Boundary Scan	75	75

Identification (ID) Register

The ID register is loaded with a vendor-specific, 32-bit code during the Capture-DR state when the IDCODE command is loaded to the instruction register. The IDCODE is hardwired into the SRAM and can be shifted out when the TAP controller is in the Shift-DR state. The ID register has vendor code and other information described in the Identification Register Definitions table.

IDENTIFICATION REGISTER DEFINITIONS

Instruction Field	Description	256K x 36	512K x 18
Revision Number (31:28)	Reserved for version number.	xxxx	xxxx
Device Depth (27:23)	Defines depth of SRAM. 256K or 512K	00111	01000
Device Width (22:18)	Defines width of the SRAM. x36 or x18	00100	00011
ISSI Device ID (17:12)	Reserved for future use.	xxxxx	xxxxx
ISSI JEDEC ID (11:1)	Allows unique identification of SRAM vendor.	00011010101	00011010101
ID Register Presence (0)	Indicate the presence of an ID register.	1	1

TAP INSTRUCTION SET

Eight instructions are possible with the three-bit instruction register and all combinations are listed in the Instruction Code table. Three instructions are listed as RESERVED and should not be used and the other five instructions are described below. The TAP controller used in this SRAM is not fully compliant with the 1149.1 convention because some mandatory instructions are not fully implemented. The TAP controller cannot be used to load address, data or control signals and cannot preload the Input or Output buffers. The SRAM does not implement the 1149.1 commands EXTEST or INTEST or the PRELOAD portion of SAMPLE/PRELOAD; instead it performs a capture of the Inputs and Output ring when these instructions are executed. Instructions are loaded into the TAP controller during the Shift-IR state when the instruction register is placed between TDI and TDO. During this state, instructions are shifted from the instruction register through the TDI and TDO pins. To execute an instruction once it is shifted in, the TAP controller must be moved into the Update-IR state.

EXTEST

EXTEST is a mandatory 1149.1 instruction which is to be executed whenever the instruction register is loaded with all 0s. Because EXTEST is not implemented in the TAP controller, this device is not 1149.1 standard compliant. The TAP controller recognizes an all-0 instruction. When an EXTEST instruction is loaded into the instruction register, the SRAM responds as if a SAMPLE/PRELOAD instruction has been loaded. There is a difference between the instructions, unlike the SAMPLE/PRELOAD instruction, EXTEST places the SRAM outputs in a High-Z state.

IDCODE

The IDCODE instruction causes a vendor-specific, 32-bit code to be loaded into the instruction register. It also places the instruction register between the TDI and TDO pins and allows the IDCODE to be shifted out of the device when the TAP controller enters the Shift-DR state. The IDCODE instruction is loaded into the instruction register upon power-up or whenever the TAP controller is given a test logic reset state.

SAMPLE-Z

The SAMPLE-Z instruction causes the boundary scan register to be connected between the TDI and TDO pins when the TAP controller is in a Shift-DR state. It also places all SRAM outputs into a High-Z state.

SAMPLE/PRELOAD

SAMPLE/PRELOAD is a 1149.1 mandatory instruction. The PRELOAD portion of this instruction is not implemented, so the TAP controller is not fully 1149.1 compliant. When the SAMPLE/PRELOAD instruction is loaded to the instruction register and the TAP controller is in the Capture-DR state, a snapshot of data on the inputs and output pins is captured in the boundary scan register.

It is important to realize that the TAP controller clock operates at a frequency up to 10 MHz, while the SRAM clock runs more than an order of magnitude faster. Because of the clock frequency differences, it is possible that during the Capture-DR state, an input or output will under-go a transition. The TAP may attempt a signal capture while in transition (metastable state). The device will not be harmed, but there is no guarantee of the value that will be captured or repeatable results.

To guarantee that the boundary scan register will capture the correct signal value, the SRAM signal must be stabilized long enough to meet the TAP controller's capture set-up plus hold times (t_{cs} and t_{ch}). To insure that the SRAM clock input is captured correctly, designs need a way to stop (or slow) the clock during a SAMPLE/PRELOAD instruction. If this is not an issue, it is possible to capture all other signals and simply ignore the value of the CLK captured in the boundary scan register.

Once the data is captured, it is possible to shift out the data by putting the TAP into the Shift-DR state. This places the boundary scan register between the TDI and TDO pins.

Note that since the PRELOAD part of the command is not implemented, putting the TAP into the Update to the Update-DR state while performing a SAMPLE/PRELOAD instruction will have the same effect as the Pause-DR command.

BYPASS

When the BYPASS instruction is loaded in the instruction register and the TAP is placed in a Shift-DR state, the bypass register is placed between the TDI and TDO pins. The advantage of the BYPASS instruction is that it shortens the boundary scan path when multiple devices are connected together on a board.

RESERVED

These instructions are not implemented but are reserved for future use. Do not use these instructions.

INSTRUCTION CODES

Code	Instruction	Description
000	EXTEST	Captures the Input/Output ring contents. Places the boundary scan register between the TDI and TDO. Forces all SRAM outputs to High-Z state. This instruction is not 1149.1 compliant.
001	IDCODE	Loads the ID register with the vendor ID code and places the register between TDI and TDO. This operation does not affect SRAM operation.
010	SAMPLE-Z	Captures the Input/Output contents. Places the boundary scan register between TDI and TDO. Forces all SRAM output drivers to a High-Z state.
011	RESERVED	Do Not Use; This instruction is reserved for future use.
100	SAMPLE/PRELOAD	Captures the Input/Output ring contents. Places the boundary scan register between TDI and TDO. Does not affect the SRAM operation. This instruction does not implement 1149.1 preload function and is therefore not 1149.1 compliant.
101	RESERVED	Do Not Use; This instruction is reserved for future use.
110	RESERVED	Do Not Use; This instruction is reserved for future use.
111	BYPASS	Places the bypass register between TDI and TDO. This operation does not affect SRAM operation.

TAP CONTROLLER STATE DIAGRAM



TAP Electrical Characteristics Over the Operating Range^(1,2)

Symbol	Parameter	Test Conditions	Min.	Max.	Units
V _{OH1}	Output HIGH Voltage	I _{OH} = -2.0 mA	1.7	—	V
V _{OH2}	Output HIGH Voltage	I _{OH} = -100 μA	2.1	—	V
V _{OL1}	Output LOW Voltage	I _{OL} = 2.0 mA	—	0.7	V
V _{OL2}	Output LOW Voltage	I _{OL} = 100 μA	—	0.2	V
V _{IH}	Input HIGH Voltage		1.7	V _{DD} + 0.3	V
V _{IL}	Input LOW Voltage		-0.3	0.7	V
I _x	Input Leakage Current	V _{SS} ≤ V _I ≤ V _{DDQ}	-10	10	μA

Notes:

- All Voltage referenced to Ground.
- Overshoot: V_{IH} (AC) ≤ V_{DD} + 1.5V for t ≤ t_{trcyc}/2,
Undershoot: V_{IL} (AC) ≥ -1.5V for t ≤ t_{trcyc}/2,
Power-up: V_{IH} < 2.6V and V_{DD} < 2.4V and V_{DDQ} < 1.4V for t < 200 ms.

TAP AC ELECTRICAL CHARACTERISTICS^(1,2) (OVER OPERATING RANGE)

Symbol	Parameter	Min.	Max.	Unit
t _{trcyc}	TCK Clock cycle time	100	—	ns
f _{TF}	TCK Clock frequency	—	10	MHz
t _{TH}	TCK Clock HIGH	40	—	ns
t _{TL}	TCK Clock LOW	40	—	ns
t _{TMSS}	TMS setup to TCK Clock Rise	10	—	ns
t _{TDIS}	TDI setup to TCK Clock Rise	10	—	ns
t _{CS}	Capture setup to TCK Rise	10	—	ns
t _{TMSH}	TMS hold after TCK Clock Rise	10	—	ns
t _{TDIH}	TDI Hold after Clock Rise	10	—	ns
t _{CH}	Capture hold after Clock Rise	10	—	ns
t _{TDOV}	TCK LOW to TDO valid	—	20	ns
t _{TDOX}	TCK LOW to TDO invalid	0	—	ns

Notes:

- Both t_{CS} and t_{CH} refer to the set-up and hold time requirements of latching data from the boundary scan register.
- Test conditions are specified using the load in TAP AC test conditions. t_r/t_f = 1 ns.

TAP AC TEST CONDITIONS (2.5V/3.3V)

Input pulse levels	0 to 2.5V/0 to 3.0V
Input rise and fall times	1ns
Input timing reference levels	1.25V/1.5V
Output reference levels	1.25V/1.5V
Test load termination supply voltage	1.25V/1.5V
Vtrig	1.25V/1.5V

TAP Output Load Equivalent



TAP TIMING





119 BGA BOUNDARY SCAN ORDER (256K X 36)

Bit #	Signal Name	Bump ID	Bit #	Signal Name	Bump ID	Bit #	Signal Name	Bump ID	Bit #	Signal Name	Bump ID
1	A	2R	19	DQb	7G	37	BWa	5L	55	DQd	2K
2	A	3T	20	DQb	6F	38	BWb	5G	56	DQd	1L
3	A	4T	21	DQb	7E	39	BWc	3G	57	DQd	2M
4	A	5T	22	DQb	7D	40	BWd	3L	58	DQd	1N
5	A	6R	23	DQb	7H	41	CE2	2B	59	DQd	1P
6	A	3B	24	DQb	6G	42	\overline{CE}	4E	60	DQd	1K
7	A	5B	25	DQb	6E	43	A	3A	61	DQd	2L
8	DQa	6P	26	DQb	6D	44	A	2A	62	DQd	2N
9	DQa	7N	27	A	6A	45	DQc	2D	63	DQd	2P
10	DQa	6M	28	A	5A	46	DQc	1E	64	MODE	3R
11	DQa	7L	29	ADV	4G	47	DQc	2F	65	A	2C
12	DQa	6K	30	ADSP	4A	48	DQc	1G	66	A	3C
13	DQa	7P	31	ADSC	4B	49	DQc	2H	67	A	5C
14	DQa	6N	32	OE	4F	50	DQc	1D	68	A	6C
15	DQa	6L	33	BWE	4M	51	DQc	2E	69	A1	4N
16	DQa	7K	34	GW	4H	52	DQc	2G	70	A0	4P
17	ZZ	7T	35	CLK	4K	53	DQc	1H			
18	DQb	6H	36	A	6B	54	NC	5R			

119 BGA BOUNDARY SCAN ORDER (512K X 18)

Bit #	Signal Name	Bump ID	Bit #	Signal Name	Bump ID	Bit #	Signal Name	Bump ID	Bit #	Signal Name	Bump ID
1	A	2R	14	DQa	7G	27	CLK	4K	40	DQb	2K
2	A	2T	15	DQa	6F	28	A	6B	41	DQb	1L
3	A	3T	16	DQa	7E	29	BWa	5L	42	DQb	2M
4	A	5T	17	DQa	6D	30	BWb	3G	43	DQb	1N
5	A	6R	18	A	6T	31	CE2	2B	44	DQb	2P
6	A	3B	19	A	6A	32	\overline{CE}	4E	45	MODE	3R
7	A	5B	20	A	5A	33	A	3A	46	A	2C
8	DQa	7P	21	ADV	4G	34	A	2A	47	A	3C
9	DQa	6N	22	ADSP	4A	35	DQb	1D	48	A	5C
10	DQa	6L	23	ADSC	4B	36	DQb	2E	49	A	6C
11	DQa	7K	24	OE	4F	37	DQb	2G	50	A1	4N
12	ZZ	7T	25	BWE	4M	38	DQb	1H	51	A0	4P
13	DQa	6H	26	GW	4H	39	NC	5R			



165 BGA BOUNDARY SCAN ORDER (x 36)

Bit #	Signal Name	Bump ID	Bit #	Signal Name	Bump ID	Bit #	Signal Name	Bump ID	Bit #	Signal Name	Bump ID
1	MODE	1R	21	DQb	11G	41	NC	1A	61	DQd	1J
2	NC	6N	22	DQb	11F	42	$\overline{CE}2$	6A	62	DQd	1K
3	A	11P	23	DQb	11E	43	$\overline{B}W_a$	5B	63	DQd	1L
4	A	8P	24	DQb	11D	44	$\overline{B}W_b$	5A	64	DQd	1M
5	A	8R	25	DQb	10G	45	$\overline{B}W_c$	4A	65	DQd	2J
6	A	9R	26	DQb	10F	46	$\overline{B}W_d$	4B	66	DQd	2K
7	A	9P	27	DQb	10E	47	CE2	3B	67	DQd	2L
8	A	10P	28	DQb	10D	48	\overline{CE}	3A	68	DQd	2M
9	A	10R	29	DQb	11C	49	A	2A	69	DQd	1N
10	A	11R	30	NC	11A	50	A	2B	70	A	3P
11	ZZ	11H	31	A	10A	51	NC	1B	71	A	3R
12	DQa	11N	32	A	10B	52	DQc	1C	72	A	4R
13	DQa	11M	33	$\overline{AD}V$	9A	53	DQc	1D	73	A	4P
14	DQa	11L	34	$\overline{AD}SP$	9B	54	DQc	1E	74	A1	6P
15	DQa	11K	35	$\overline{AD}SC$	8A	55	DQc	1F	75	A0	6R
16	DQa	11J	36	\overline{OE}	8B	56	DQc	1G			
17	DQa	10M	37	$\overline{B}W_E$	7A	57	DQc	2D			
18	DQa	10L	38	\overline{GW}	7B	58	DQc	2E			
19	DQa	10K	39	CLK	6B	59	DQc	2F			
20	DQa	10J	40	NC	11B	60	DQc	2G			



165 BGA BOUNDARY SCAN ORDER (x 18)

Bit #	Signal Name	Bump ID	Bit #	Signal Name	Bump ID	Bit #	Signal Name	Bump ID	Bit #	Signal Name	Bump ID
1	MODE	1R	21	DQa	11G	41	NC	1A	61	DQb	1J
2	NC	6N	22	DQa	11F	42	$\overline{CE2}$	6A	62	DQb	1K
3	A	11P	23	DQa	11E	43	\overline{BWa}	5B	63	DQb	1L
4	A	8P	24	DQa	11D	44	NC	5A	64	DQb	1M
5	A	8R	25	DQa	11C	45	\overline{BWb}	4A	65	DQb	1N
6	A	9R	26	NC	10F	46	NC	4B	66	NC	2K
7	A	9P	27	NC	10E	47	CE2	3B	67	NC	2L
8	A	10P	28	NC	10D	48	\overline{CE}	3A	68	NC	2M
9	A	10R	29	NC	10G	49	A	2A	69	NC	2J
10	A	11R	30	A	11A	50	A	2B	70	A	3P
11	ZZ	11H	31	A	10A	51	NC	1B	71	A	3R
12	NC	11N	32	A	10B	52	NC	1C	72	A	4R
13	NC	11M	33	\overline{ADV}	9A	53	NC	1D	73	A	4P
14	NC	11L	34	\overline{ADSP}	9B	54	NC	1E	74	A1	6P
15	NC	11K	35	\overline{ADSC}	8A	55	NC	1F	75	A0	6R
16	NC	11J	36	\overline{OE}	8B	56	NC	1G			
17	DQa	10M	37	\overline{BWE}	7A	57	DQb	2D			
18	DQa	10L	38	\overline{GW}	7B	58	DQb	2E			
19	DQa	10K	39	CLK	6B	59	DQb	2F			
20	DQa	10J	40	NC	11B	60	DQb	2G			



ORDERING INFORMATION (3.3V core/2.5V-3.3V I/O)

Commercial Range: 0°C to +70°C

Configuration	Frequency	Order Part Number	Package⁽¹⁾
256Kx36			
	250	IS61LPS25636A-250TQ	100 QFP, 3CE
		IS61LPS25636A-250B2	119 BGA
		IS61LPS25636A-250B3	165 BGA
	200	IS61LPS25636A-200TQ	100 QFP, 3CE
		IS61LPS25636A-200B2	119 BGA
		IS61LPS25636A-200B3	165 BGA
	166	IS61LPS25636A-166TQ	100 QFP, 3CE
		IS61LPS25636A-166TQL	100 QFP, 3CE, Lead-free
512Kx18			
	250	IS61LPS51218A-250TQ	100 QFP, 3CE
		IS61LPS51218A-250B2	119 BGA
		IS61LPS51218A-250B3	165 BGA
	200	IS61LPS51218A-200TQ	100 QFP, 3CE
		IS61LPS51218A-200B2	119 BGA
		IS61LPS51218A-200B3	165 BGA



**IS61LPS51218A, IS61LPS25636A, IS61LPS25632A, IS64LPS25636A,
IS61VPS51218A, IS61VPS25636A**

Industrial Range: -40°C to +85°C

Configuration	Frequency	OrderPartNumber	Package ⁽¹⁾
256Kx32			
	200	IS61LPS25632A-200TQLI	100 QFP,3CE,Lead-free
256Kx36			
	250	IS61LPS25636A-250TQI	100 QFP,3CE
		IS61LPS25636A-250TQLI	100 QFP,3CE,Lead-free
		IS61LPS25636A-250B2I	119 BGA
		IS61LPS25636A-250B3I	165 BGA
	200	IS61LPS25636A-200TQI	100 QFP,3CE
		IS61LPS25636A-200TQ2LI	100 QFP,2CE,Lead-free
		IS61LPS25636A-200TQ2I	100 QFP,2CE
		IS61LPS25636A-200TQLI	100 QFP,3CE,Lead-free
		IS61LPS25636A-200B2I	119 BGA
		IS61LPS25636A-200B2LI	119 BGA,Lead-free
		IS61LPS25636A-200B3I	165 BGA
	166	IS61LPS25636A-200B3LI	165 BGA,Lead-free
512Kx18			
	250	IS61LPS51218A-250TQI	100 QFP,3CE
		IS61LPS51218A-250B2I	119 BGA
		IS61LPS51218A-250B3I	165 BGA
	200	IS61LPS51218A-200TQI	100 QFP,3CE
		IS61LPS51218A-200TQ2LI	100 QFP,2CE,Lead-free
		IS61LPS51218A-200TQ2I	100 QFP,2CE
		IS61LPS51218A-200TQLI	100 QFP,3CE,Lead-free
		IS61LPS51218A-200B2I	119 BGA
		IS61LPS51218A-200B3I	165 BGA

Note:

1. For 100 QFP, 2CE option contact SRAM Marketing at sram@issi.com

Automotive Range: -40°C to +125°C

Configuration	Frequency	Order Part Number	Package
256Kx36			
	166	IS64LPS25636A-166TQLA3	100 QFP, 3CE



ORDERING INFORMATION (2.5V core/2.5V I/O)

Commercial Range: 0°C to +70°C

Configuration	Frequency	Order Part Number	Package ⁽¹⁾
256Kx36			
	250	IS61VPS25636A-250TQ IS61VPS25636A-250B2 IS61VPS25636A-250B3	100 QFP, 3CE 119 BGA 165 BGA
	200	IS61VPS25636A-200TQ IS61VPS25636A-200B2 IS61VPS25636A-200B3	100 QFP, 3CE 119 BGA 165 BGA
512Kx18			
	250	IS61VPS51218A-250TQ IS61VPS51218A-250B2 IS61VPS51218A-250B3	100 QFP, 3CE 119 BGA 165 BGA
	200	IS61VPS51218A-200TQ IS61VPS51218A-200B2 IS61VPS51218A-200B3	100 QFP, 3CE 119 BGA 165 BGA

Industrial Range: -40°C to +85°C

Configuration	Frequency	Order Part Number	Package ⁽¹⁾
256Kx36			
	250	IS61VPS25636A-250TQI IS61VPS25636A-250B2I IS61VPS25636A-250B3I	100 QFP, 3CE 119 BGA 165 BGA
	200	IS61VPS25636A-200TQI IS61VPS25636A-200TQ2I IS61VPS25636A-200TQLI IS61VPS25636A-200B2I IS61VPS25636A-200B3I	100 QFP, 3CE 100 QFP, 2CE 100 QFP, 3CE, Lead-free 119 BGA 165 BGA
512Kx18			
	250	IS61VPS51218A-250TQI IS61VPS51218A-250B2I IS61VPS51218A-250B3I	100 QFP, 3CE 119 BGA 165 BGA
	200	IS61VPS51218A-200TQI IS61VPS51218A-200TQ2I IS61VPS51218A-200B2I IS61VPS51218A-200B3I	100 QFP, 3CE 100 QFP, 2CE 119 BGA 165 BGA

Note:

1. For 100 QFP, 2CE option contact SRAM Marketing at sram@issi.com



SYMBOL	DIMENSION IN MM		DIMENSION IN INCH	
	MIN.	NOM.	MAX.	NOM. MAX.
A	1.40		1.60	0.055
A1	0.05		0.15	0.006
A2	1.35	1.40	1.45	0.053
b	0.22	0.30	0.38	0.009
D	21.90	22.00	22.10	0.862
D1	19.90	20.00	20.10	0.783
E	15.90	16.00	16.10	0.626
E1	13.90	14.00	14.10	0.547
e	0.65 BSC.		0.026 BSC.	
L	0.45	0.60	0.75	0.018
L1	0.25 BSC.		0.010 BSC.	
ZD	0.575 REF.		0.023 REF.	
ZE	0.825 REF.		0.032 REF.	
theta	0	3.5°	7°	0
				3.5°
				7°

NOTE :

1. CONTROLLING DIMENSION : MM
2. DIMENSION D1 AND E1 DO NOT INCLUDE MOLD PROTRUSION.
3. DIMENSION b DOES NOT INCLUDE DAMBAR PROTRUSION/INTRUSION.

	TITLE	REV.	DATE
	100L14x20x1.4mm LQFP (Footprint : 2.0 mm) Package Outline	F	09/01/2009

TOP VIEW



BOTTOM VIEW



NOTE :

1. CONTROLLING DIMENSION : MM .
2. Reference document : JEDEC MS-028

SYMBOL	DIMENSION IN MM		DIMENSION IN INCH			
	MIN.	MAX.	MIN.	MAX.		
A	-	2.15	3.50	-	0.085	0.138
A1	0.50	0.60	0.70	0.020	0.024	0.028
ϕ_b	0.66	0.76	0.86	0.026	0.030	0.034
D	21.80	22.00	22.20	0.858	0.866	0.874
D1	20.32	BSC.	0.800	BSC.		
D2	19.90	20.00	20.10	0.783	0.787	0.791
E	13.80	14.00	14.20	0.551	0.559	
E1	7.62	BSC.	0.300	BSC.		
E2	11.90	12.00	12.10	0.468	0.472	0.476
e	1.27	BSC.	0.050	BSC.		
ZD	0.84	REF.	0.033	REF.		
ZE	3.19	REF.	0.126	REF.		



TITLE

119L 14x22mm PBGA
Package Outline

REV.

D

DATE

10/02/2008

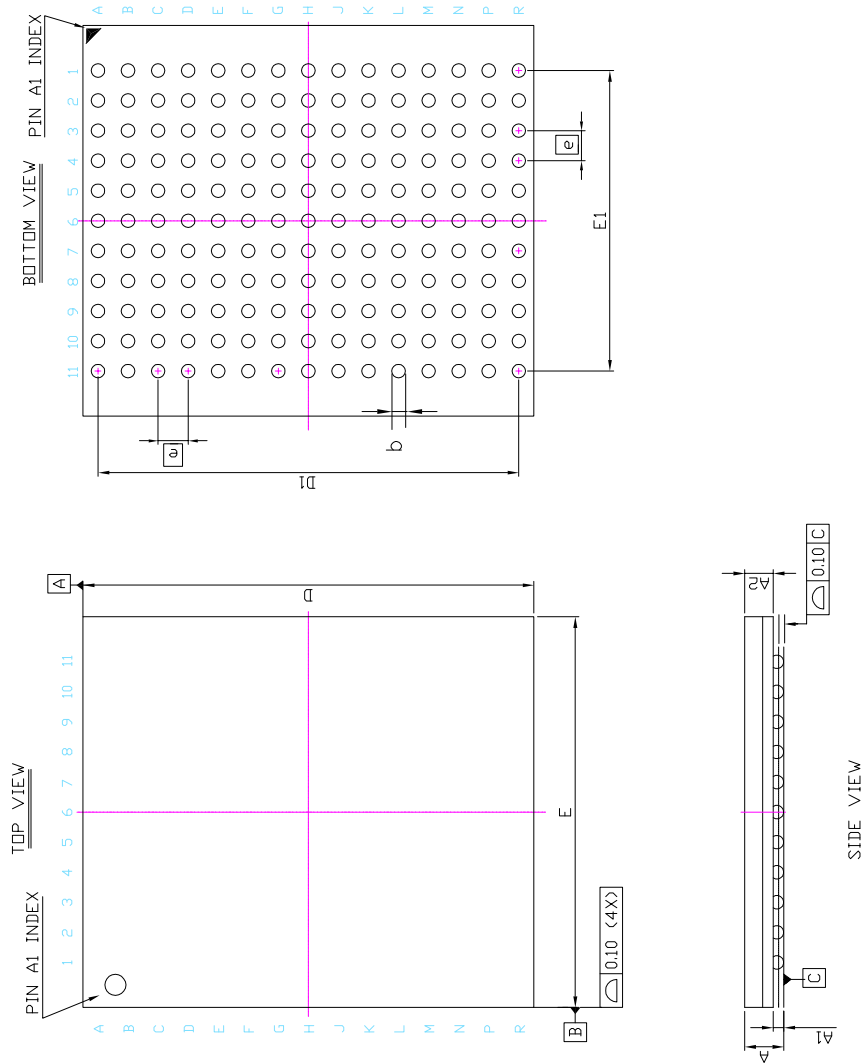

SYM.	DIMENSION (mm)			DIMENSION (inch)		
	MIN.	NOM.	MAX.	MIN.	NOM.	MAX.
A	—	—	1.20	—	—	0.047
A1	0.25	0.35	0.40	0.010	0.014	0.016
A2	—	0.79	—	—	0.031	—
b	0.40	0.45	0.50	0.016	0.018	0.020
D	14.90	15.00	15.10	0.587	0.591	0.594
D1	13.90	14.00	14.10	0.547	0.551	0.555
E	12.90	13.00	13.10	0.508	0.512	0.516
E1	9.90	10.00	10.10	0.390	0.394	0.398
\square	1.00 BSC			0.039 BSC		

NOTE :

1. CONTROLLING DIMENSION : MM .



TITLE

165L 13x15mm TF-BGA
Package Outline

REV.

B

DATE

08/28/2008