



ON Semiconductor®

# RURP15100-F085 15A 1000V Ultrafast Rectifier

## Features

- High Speed Switching ( $t_{rr}=200\text{ns(Typ.)}$  @  $I_F=15\text{A}$ )
- Low Forward Voltage ( $V_F=1.8\text{V(Max.)}$  @  $I_F=15\text{A}$ )
- Avalanche Energy Rated
- AEC-Q101 Compliant

## Applications

- Automotive DCDC converter
- Automotive On Board Charger
- Switching Power Supply
- Power Switching Circuits

## 15A, 1000V Ultrafast Rectifier

The RURP15100-F085 is an ultrafast diode with soft recovery characteristics ( $t_{rr}< 200\text{ns}$ ). It has a low forward voltage drop and is of silicon nitride passivated, ion-implanted, epitaxial construction.

This device is intended for use as a freewheeling/clamping diode and rectifier in a variety of automotive power supplies and other power switching automotive applications. Its low stored charge and ultrafast recovery with soft recovery characteristics minimizes ringing and electrical noise in many power switching circuits, thus reducing power loss in the switching transistor.

## Pin Assignments

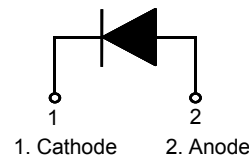
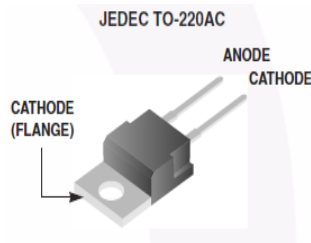

## Absolute Maximum Ratings $T_C = 25^\circ\text{C}$ unless otherwise noted

Symbol	Parameter	Ratings	Units
$V_{RRM}$	Peak Repetitive Reverse Voltage	1000	V
$V_{RWM}$	Working Peak Reverse Voltage	1000	V
$V_R$	DC Blocking Voltage	1000	V
$I_{F(AV)}$	Average Rectified Forward Current @ $T_C = 25^\circ\text{C}$	15	A
$I_{FSM}$	Non-repetitive Peak Surge Current	45	A
$E_{AVL}$	Avalanche Energy(1A,40mH)	20	mJ
$T_J, T_{STG}$	Operating Junction and Storage Temperature	- 55 ~175	$^\circ\text{C}$

## Thermal Characteristics $T_C = 25^\circ\text{C}$ unless otherwise noted

Symbol	Parameter	Max	Units
$R_{\theta JC}$	Maximum Thermal Resistance, Junction to Case	0.94	$^\circ\text{C/W}$
$R_{\theta JA}$	Maximum Thermal Resistance, Junction to Ambient	85	$^\circ\text{C/W}$

## Package Marking and Ordering Information

Device Marking	Device	Package	Tube	Quantity
RURP15100	RURP15100-F085	TO-220AC	-	50

RURP15100-F085 15A 1000V Ultrafast Rectifier

**Electrical Characteristics**  $T_C = 25^\circ\text{C}$  unless otherwise noted

Symbol	Parameter	Conditions	Min.	Typ.	Max	Units	
$I_R$	Instantaneous Reverse Current	$V_R = 1000\text{V}$	$T_C = 25^\circ\text{C}$	-	-	100	$\mu\text{A}$
			$T_C = 175^\circ\text{C}$	-	-	1000	$\mu\text{A}$
$V_F^1$	Instantaneous Forward Voltage	$I_F = 15\text{A}$	$T_C = 25^\circ\text{C}$	-	1.35	1.8	V
			$T_C = 175^\circ\text{C}$	-	1.14	1.6	V
$t_{rr}^2$	Reverse Recovery Time	$I_F = 1\text{A}, di/dt = 100\text{A}/\mu\text{s}, V_R = 650\text{V}$	$T_C = 25^\circ\text{C}$	-	126	260	ns
			$T_C = 175^\circ\text{C}$	-	200	450	ns
$t_a$ $t_b$ $Q_{rr}$	Reverse Recovery Time	$I_F = 15\text{A}, di/dt = 100\text{A}/\mu\text{s}, V_R = 650\text{V}$	$T_C = 25^\circ\text{C}$	-	63	-	ns
			$T_C = 175^\circ\text{C}$	-	137	-	ns
$Q_{rr}$	Reverse Recovery Charge	$I_F = 15\text{A}, di/dt = 100\text{A}/\mu\text{s}, V_R = 650\text{V}$	$T_C = 25^\circ\text{C}$	-	683	-	nC
			$T_C = 175^\circ\text{C}$	-	720	-	nC
$W_{AVL}$	Avalanche Energy	$I_{AV} = 1.0\text{A}, L = 40\text{mH}$	20	-	-	mJ	

**Notes:**

1. Pulse : Test Pulse width =  $300\mu\text{s}$ , Duty Cycle = 2%
2. Guaranteed by design.

**Test Circuit and Waveforms**

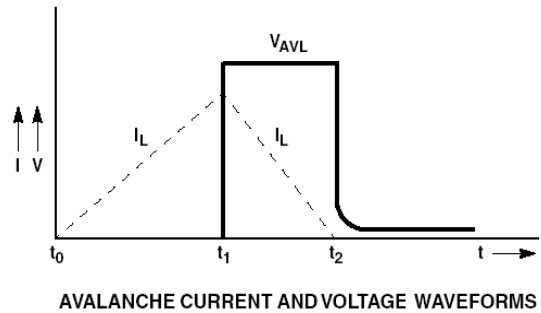
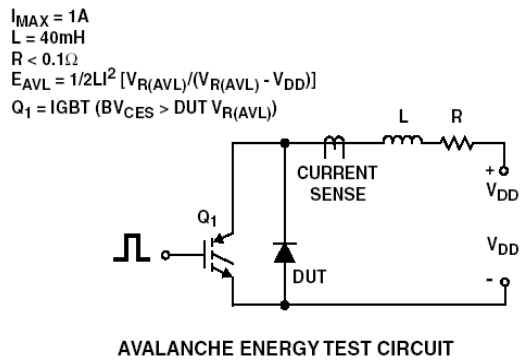
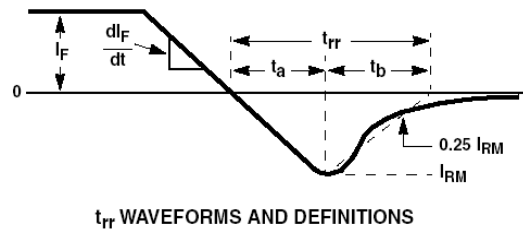
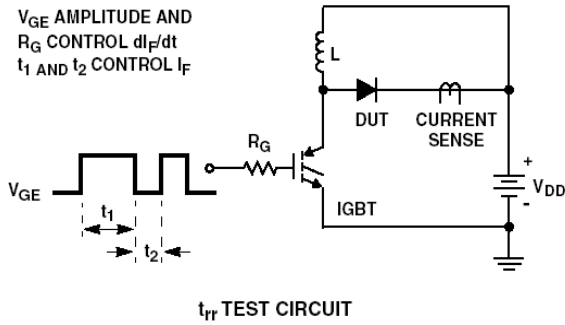

## Typical Performance Characteristics

**Figure 1. Typical Forward Voltage Drop vs. Forward Current**

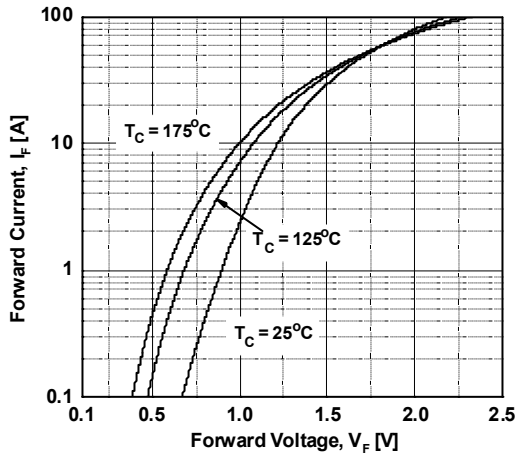

**Figure 3. Typical Junction Capacitance**

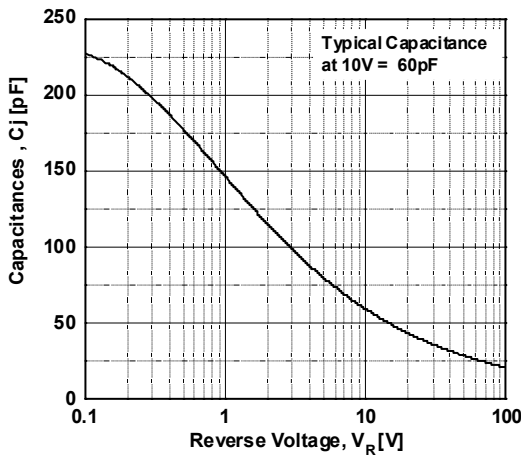

**Figure 5. Typical Reverse Recovery Current vs. di/dt**

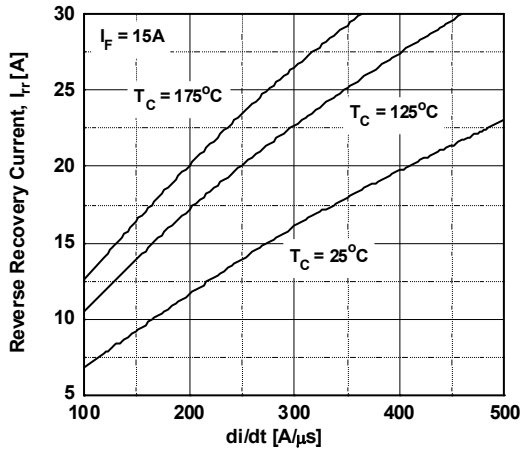

**Figure 2. Typical Reverse Current vs. Reverse Voltage**

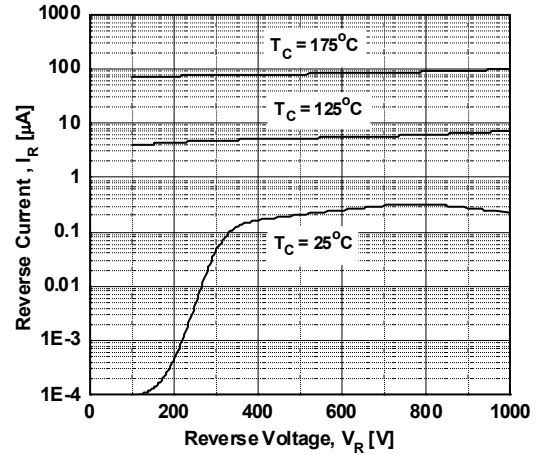

**Figure 4. Typical Reverse Recovery Time vs. di/dt**

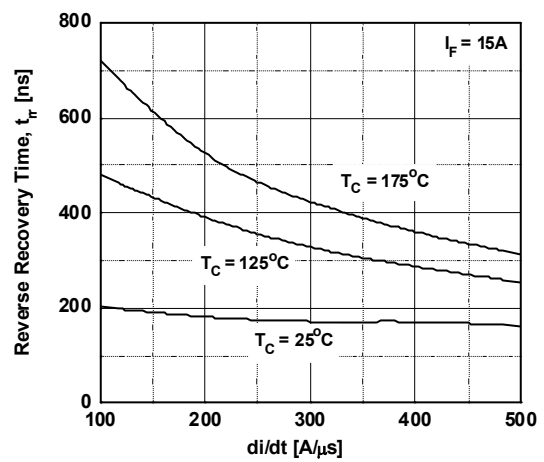

**Figure 6. Forward Current Derating Curve**

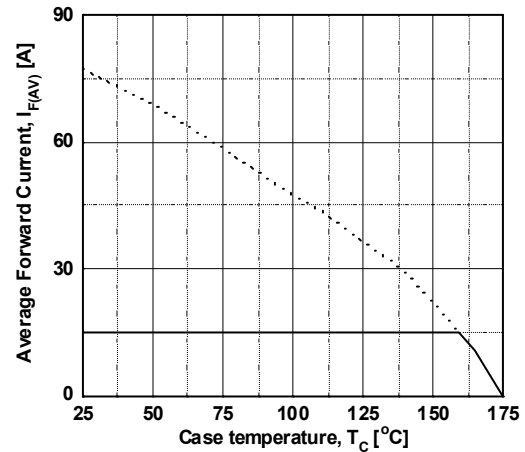

Typical Performance Characteristics (Continued)

Figure 7. Reverse Recovery Charge

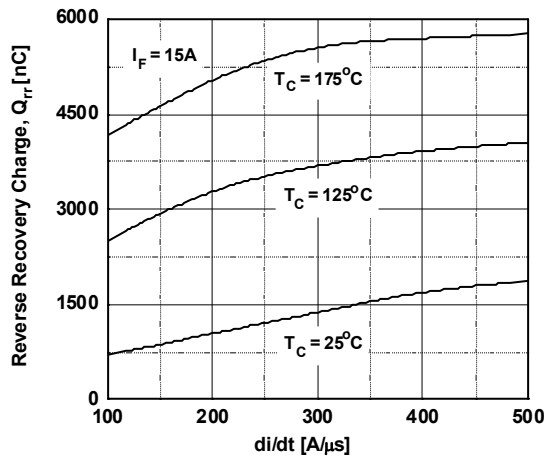
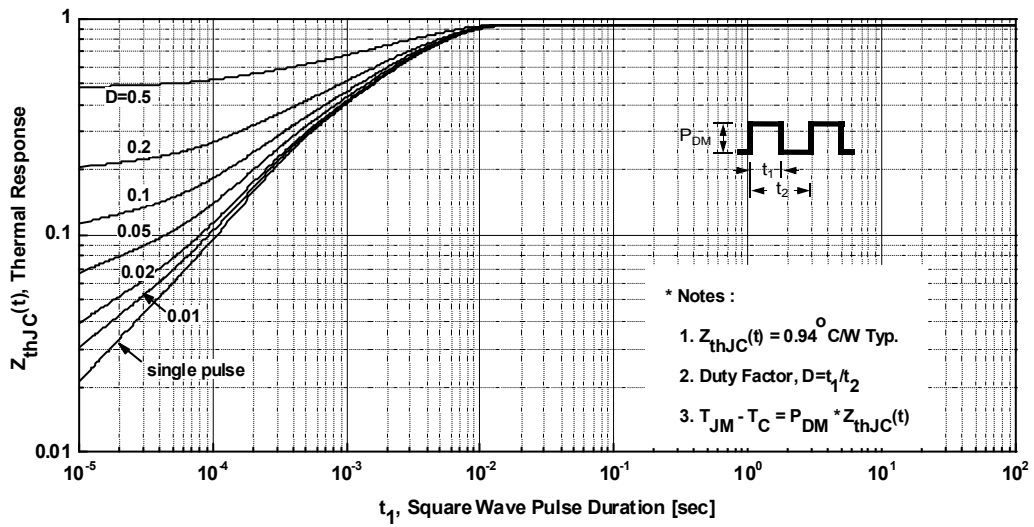

Figure 8. Transient Thermal Response Curve





ON Semiconductor and  are trademarks of Semiconductor Components Industries, LLC dba ON Semiconductor or its subsidiaries in the United States and/or other countries. ON Semiconductor owns the rights to a number of patents, trademarks, copyrights, trade secrets, and other intellectual property. A listing of ON Semiconductor's product/patent coverage may be accessed at [www.onsemi.com/site/pdf/Patent-Marking.pdf](http://www.onsemi.com/site/pdf/Patent-Marking.pdf). ON Semiconductor reserves the right to make changes without further notice to any products herein. ON Semiconductor makes no warranty, representation or guarantee regarding the suitability of its products for any particular purpose, nor does ON Semiconductor assume any liability arising out of the application or use of any product or circuit, and specifically disclaims any and all liability, including without limitation special, consequential or incidental damages. Buyer is responsible for its products and applications using ON Semiconductor products, including compliance with all laws, regulations and safety requirements or standards, regardless of any support or applications information provided by ON Semiconductor. "Typical" parameters which may be provided in ON Semiconductor data sheets and/or specifications can and do vary in different applications and actual performance may vary over time. All operating parameters, including "Typicals" must be validated for each customer application by customer's technical experts. ON Semiconductor does not convey any license under its patent rights nor the rights of others. ON Semiconductor products are not designed, intended, or authorized for use as a critical component in life support systems or any FDA Class 3 medical devices or medical devices with a same or similar classification in a foreign jurisdiction or any devices intended for implantation in the human body. Should Buyer purchase or use ON Semiconductor products for any such unintended or unauthorized application, Buyer shall indemnify and hold ON Semiconductor and its officers, employees, subsidiaries, affiliates, and distributors harmless against all claims, costs, damages, and expenses, and reasonable attorney fees arising out of, directly or indirectly, any claim of personal injury or death associated with such unintended or unauthorized use, even if such claim alleges that ON Semiconductor was negligent regarding the design or manufacture of the part. ON Semiconductor is an Equal Opportunity/Affirmative Action Employer. This literature is subject to all applicable copyright laws and is not for resale in any manner.

## PUBLICATION ORDERING INFORMATION

### LITERATURE FULFILLMENT:

Literature Distribution Center for ON Semiconductor  
19521 E. 32nd Pkwy, Aurora, Colorado 80011 USA  
**Phone:** 303-675-2175 or 800-344-3860 Toll Free USA/Canada  
**Fax:** 303-675-2176 or 800-344-3867 Toll Free USA/Canada  
**Email:** [orderlit@onsemi.com](mailto:orderlit@onsemi.com)

**N. American Technical Support:** 800-282-9855 Toll Free  
USA/Canada  
**Europe, Middle East and Africa Technical Support:**  
Phone: 421 33 790 2910  
**Japan Customer Focus Center**  
Phone: 81-3-5817-1050

**ON Semiconductor Website:** [www.onsemi.com](http://www.onsemi.com)  
**Order Literature:** <http://www.onsemi.com/orderlit>  
For additional information, please contact your local  
Sales Representative