

### Applications

- Electronic Warfare
- Radar
- Test Instrumentation
- EMC Amplifier



### Product Features

- Frequency Range: 2.5 to 6 GHz
- $P_{SAT}$ : 46.5 dBm @  $P_{IN} = 26$  dBm
- PAE: 35%
- Small Signal Gain: 29 dB
- Bias: Pulse  $V_D = 30$  V,  $I_{DQ} = 1.55$ A,  $V_G = -2.4$  V Typ  
Pulse: PW = 150 us, DC = 5%
- Dimensions: 12.7 x 12.7 x 3.89 mm

### Functional Block Diagram

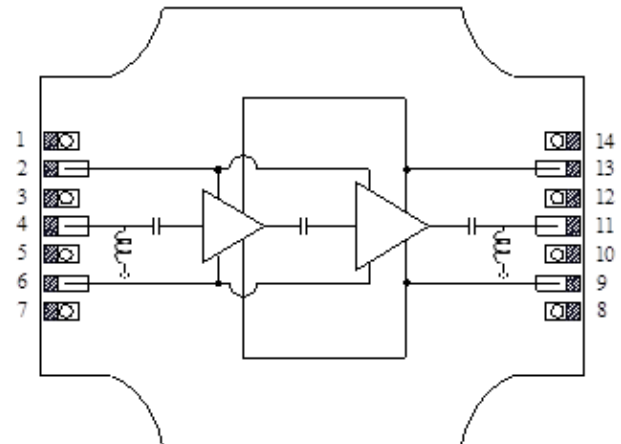

### General Description

TriQuint's TGA2576-FS is a packaged wideband power amplifier designed on TriQuint's production 0.25 um GaN on SiC process. Operating from 2.5 to 6 GHz, the TGA2576-FS achieves 40 W of saturated output power, greater than 35% power-added efficiency and 29 dB small signal gain.

Both RF ports are fully matched to 50  $\Omega$ , the TGA2576-FS is ideally suited to support both commercial and defense related opportunities.

Lead-free and RoHS compliant

Evaluation Boards are available up on request.

### Pin Configuration

Pin No.	Symbol
1, 3, 5, 7, 8, 10, 12, 14	GND
2, 6	$V_G$
4	$RF_{IN}$
9, 13	$V_D$
11	$RF_{OUT}$

### Ordering Information

Part	ECCN	Description
TGA2576-FS	3A001.b.2.a	2.5 to 6 GHz 40W GaN PA

### Absolute Maximum Ratings

Parameter	Value
Drain Voltage ( $V_D$ )	40 V
Gate Voltage ( $V_G$ )	-5 to 0 V
Drain Current ( $I_D$ )	5000 mA
Gate Current ( $I_G$ )	-18 to 35 mA
Power Dissipation ( $P_{DISS, Pulse}$ )	120 W
RF Input Power, CW, 50 $\Omega$ , T = 25°C	28 dBm
Channel temperature ( $T_{CH}$ )	275°C
Mounting Temperature (30 Seconds)	260°C
Storage Temperature	-40 to 150°C

Operation of this device outside the parameter ranges given above may cause permanent damage. These are stress ratings only, and functional operation of the device at these conditions is not implied.

### Recommended Operating Conditions

Parameter	Value
Drain Voltage ( $V_D$ ), Pulsed: PW = 150 us, DC = 5%; not recommend for CW	30 V
Drain Current ( $I_{DQ}$ )	1550 mA
Drain Current Under RF Drive ( $I_{D\_DRIVE}$ )	see plots p. 8
Gate Voltage ( $V_G$ )	-2.4 V Typical
Temperature backside package ( $T_{BASE}$ )	-40 °C to $\leq$ 85 °C (see $T_{BASE}$ derating plots p.3 & p.4)

Electrical specifications are measured at specified test conditions. Specifications are not guaranteed over all operating conditions.

### Electrical Specifications

Test conditions unless otherwise noted: 25°C,  $V_D = 30$  V,  $I_{DQ} = 1550$  mA, Pulsed: PW = 150 us, DC = 5%,  $V_G = -2.4$  V Typical; not recommend for CW

Parameter	Min	Typical	Max	Units
Operational Frequency Range	2.5		6	GHz
Small Signal Gain		29		dB
Input Return Loss		15		dB
Output Return Loss		10		dB
Output Power @ Saturation ( $P_{in} = 26$ dBm)		46.5		dBm
Power-Added Efficiency ( $P_{in} = 26$ dBm)		35		%
IM3 @ $P_{out}/Tone = 36$ dBm		-15		dBc
IM5 @ $P_{out}/Tone = 36$ dBm		-30		dBc
Small Signal Gain Temperature Coefficient		-0.05		dB/°C
Output Power Temperature Coefficient		-0.01		dBm/°C

### Thermal and Reliability Information

Parameter	Test Conditions	Value	Units
Thermal Resistance ( $\theta_{JC}$ ) <sup>(1)</sup>	$T_{BASE} = 85^{\circ}C$ , $V_D = 30$ V Pulse PW = 150 us, DC = 10 %	1.31	$^{\circ}C/W$
Channel Temperature ( $T_{CH}$ )	Freq = 4 GHz, $P_{IN} = 26$ dBm: $I_{DQ} = 1.5$ A, $I_{D Drive} = 3.8$ A $P_{OUT} = 46$ dBm	182	$^{\circ}C$
Median Lifetime ( $T_M$ )	$P_{DISS} = 74$ W	$6.6 \times 10^7$	Hours

Notes:

1. Measured junction to package backside.

Test Conditions:  $V_D = 40V$ ; Failure Criteria is 10% reduction in  $I_{D MAX}$

### Median Lifetime vs. Channel Temperature

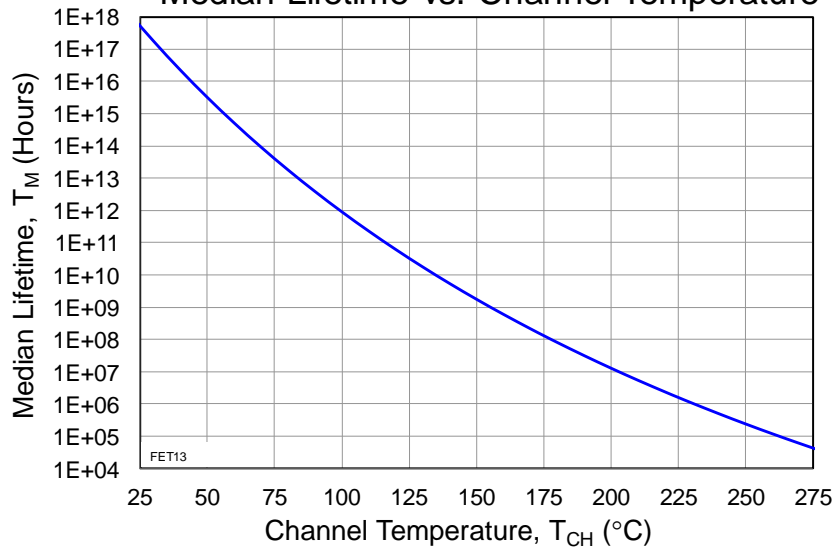

### Thermal Resistance vs. Power Dissipation

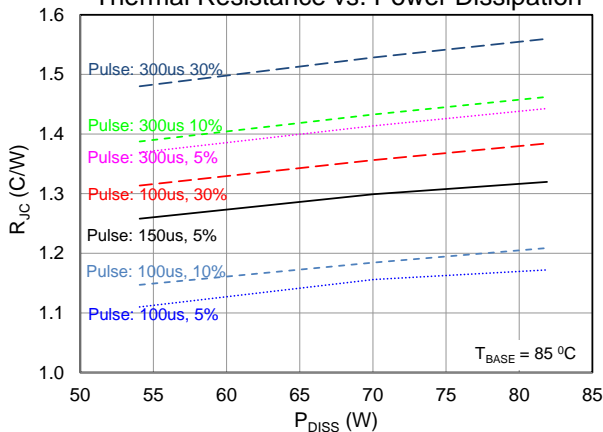

### Temperature Derating $T_{BASE}$ vs. $P_{OUT,AVG}$

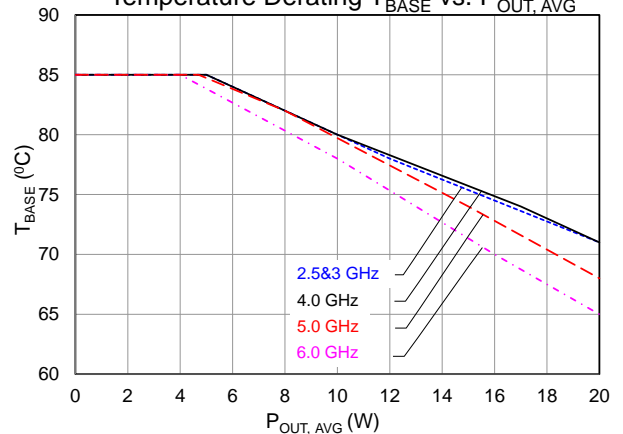

**Thermal and Reliability Information (Con't.)**

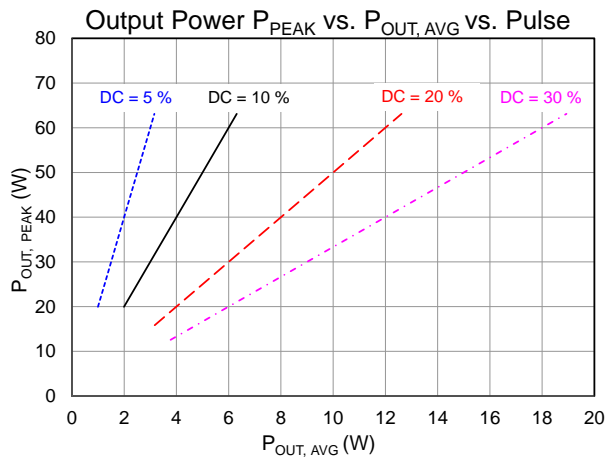
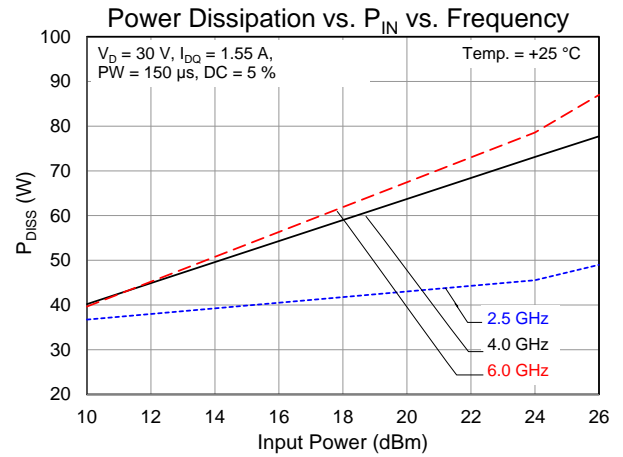
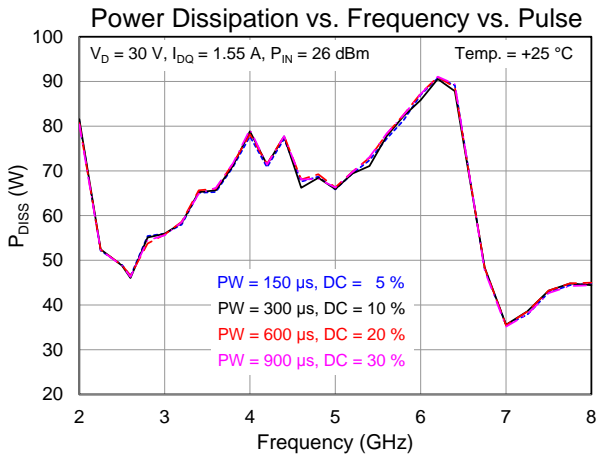
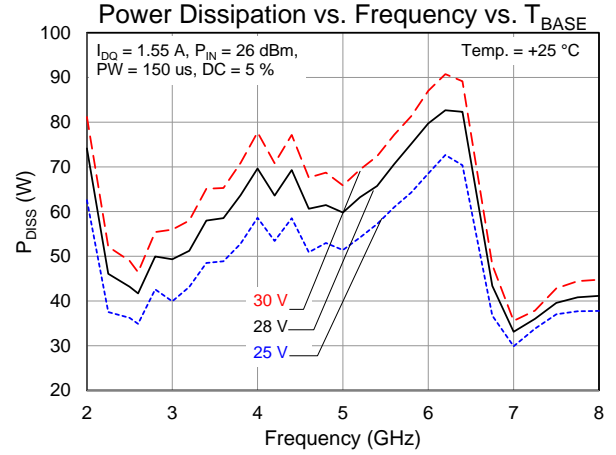
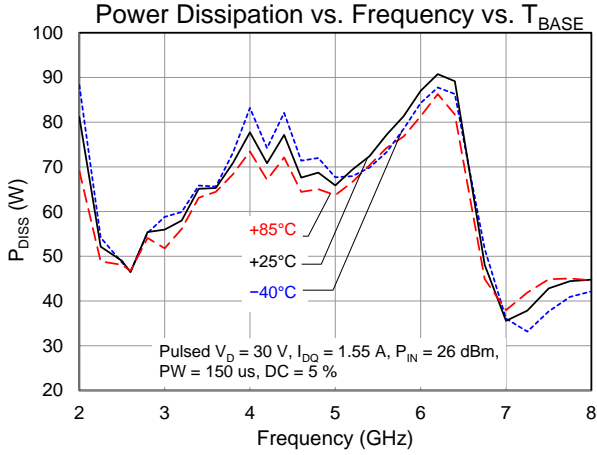

**Typical Performance: Small Signal, CW**

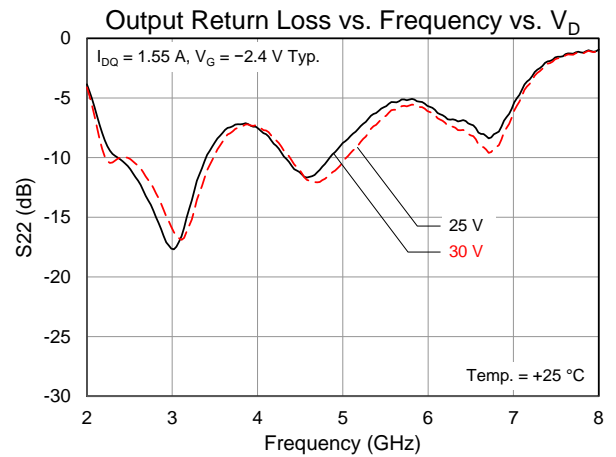
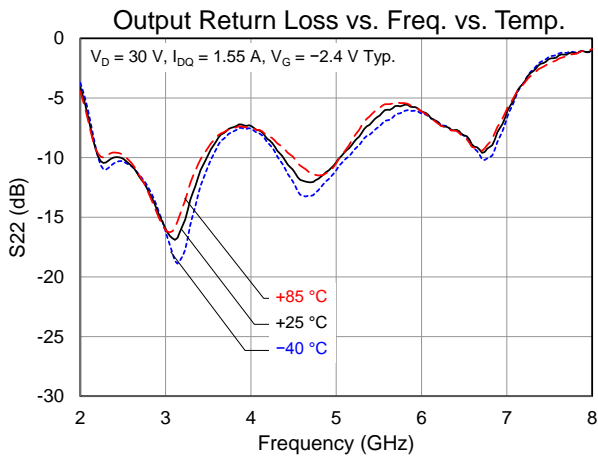
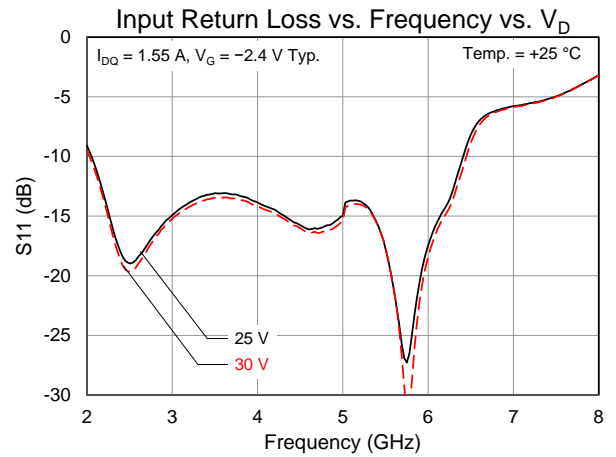
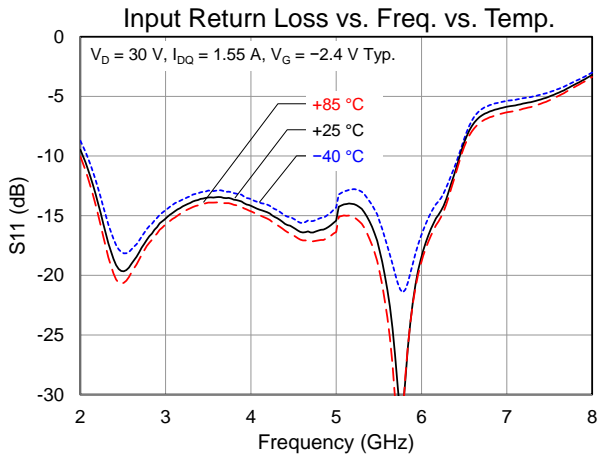
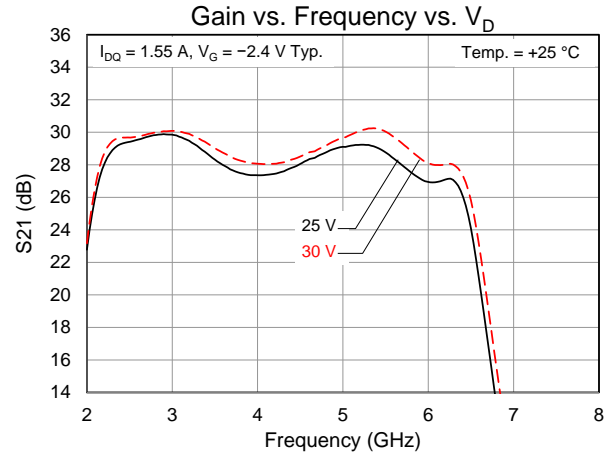
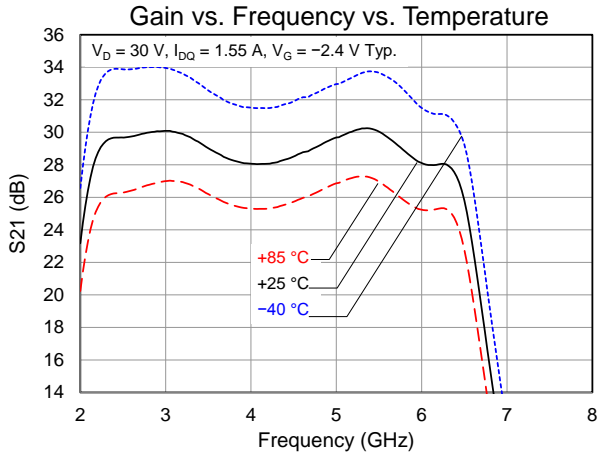

### Typical Performance: Large Signal, Pulse

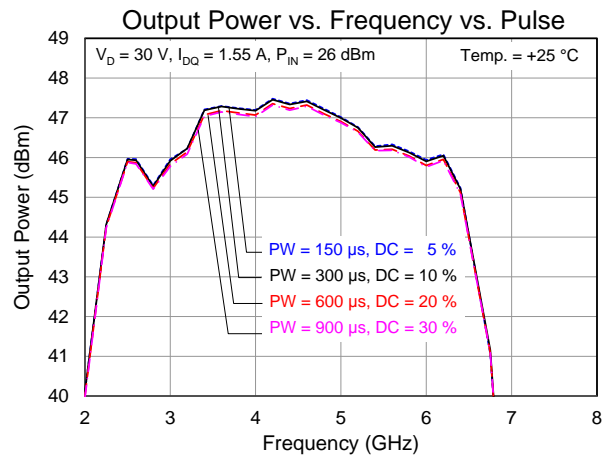
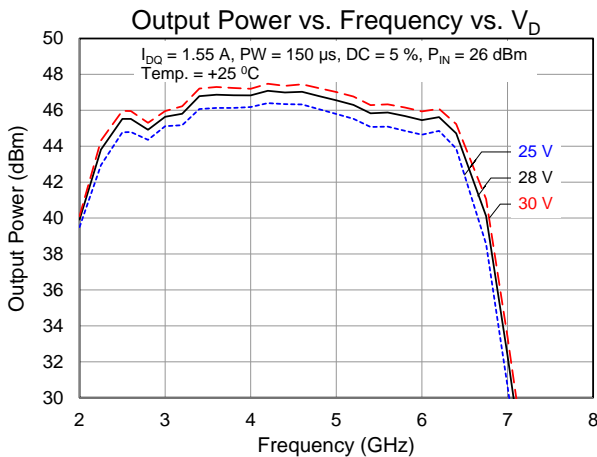
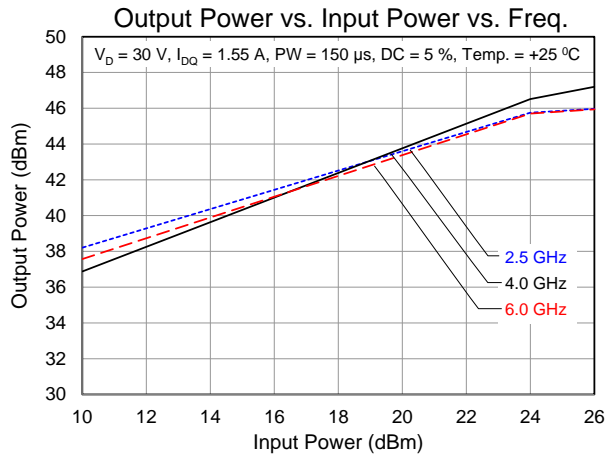
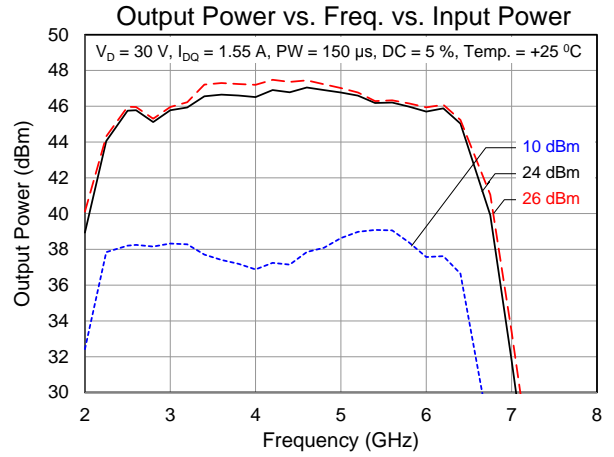
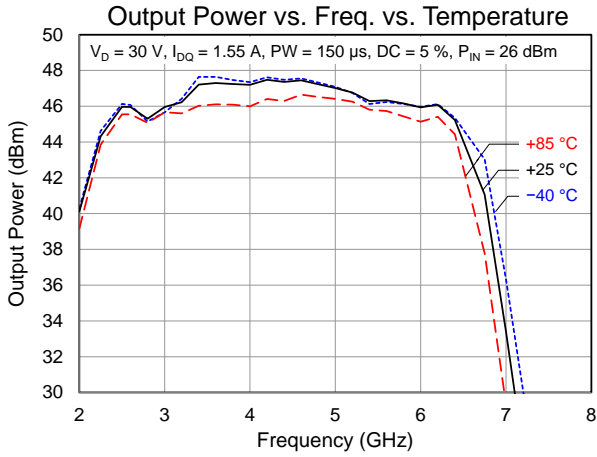

### Typical Performance: Large Signal, Pulse

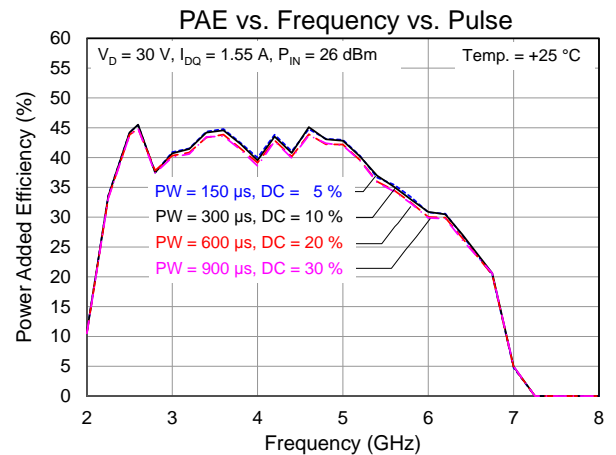
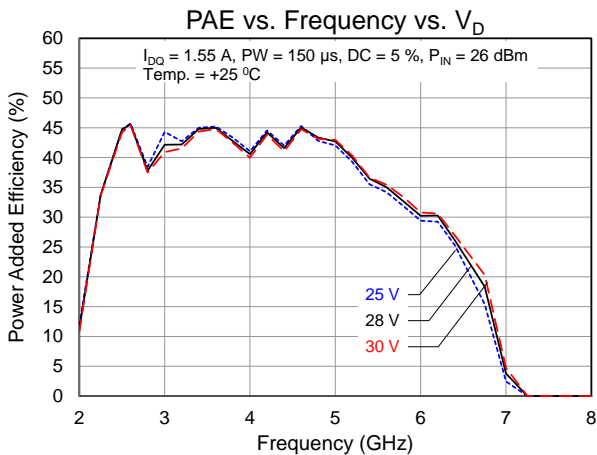
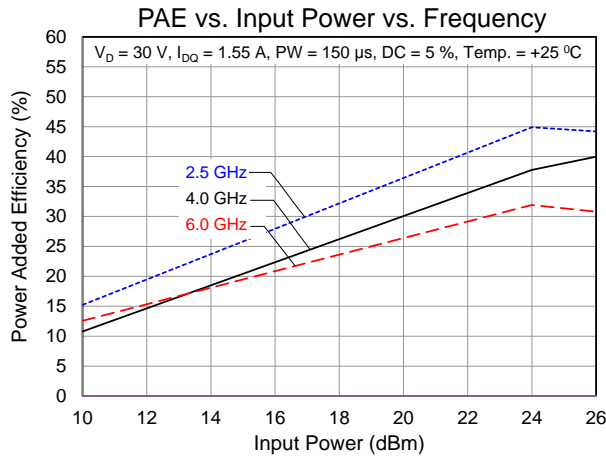
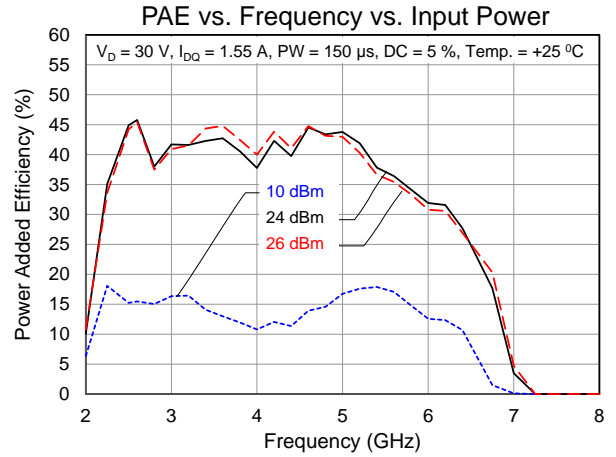
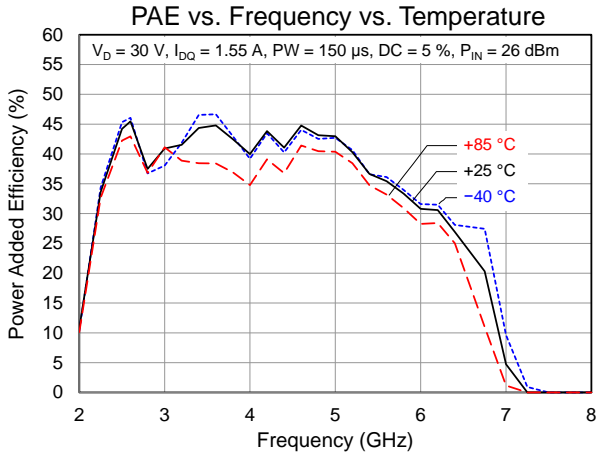

### Typical Performance: Large Signal, Pulse

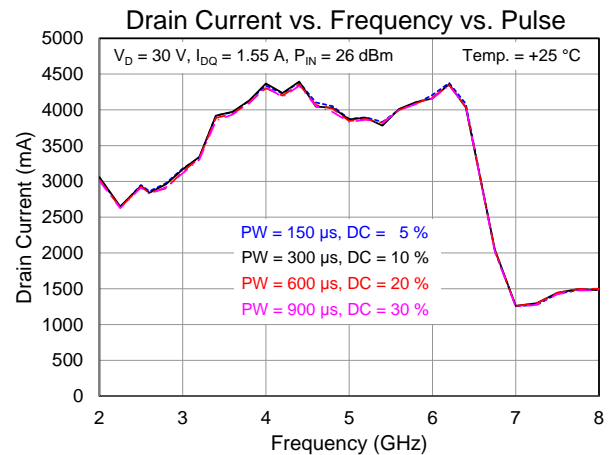
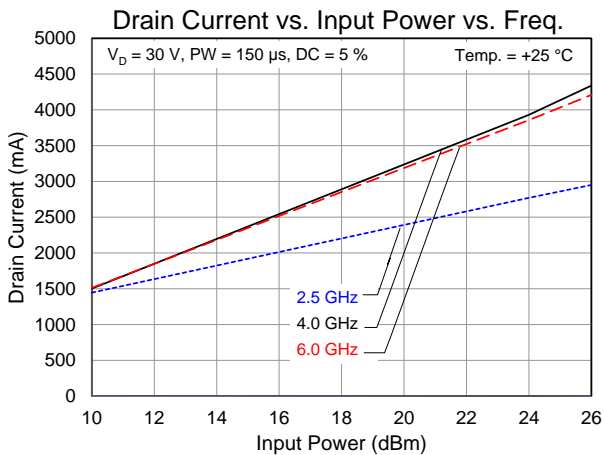
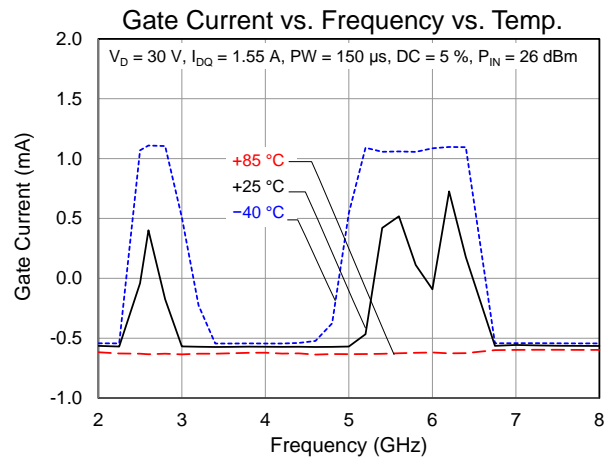
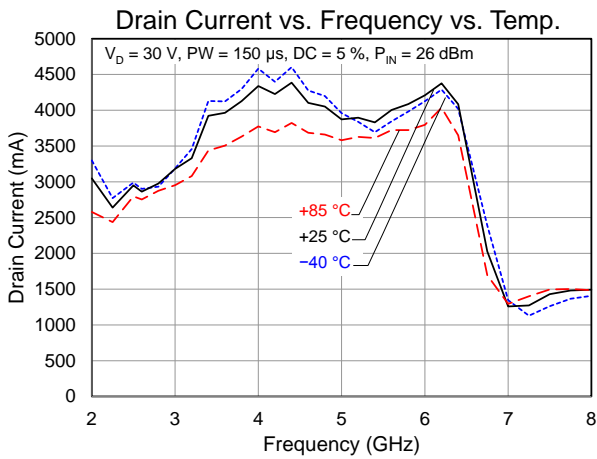
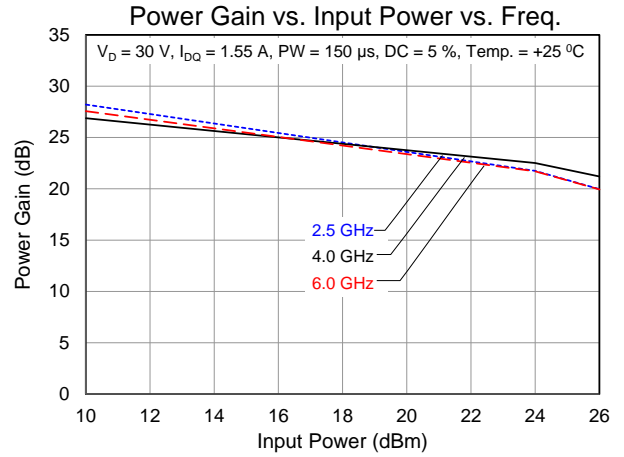
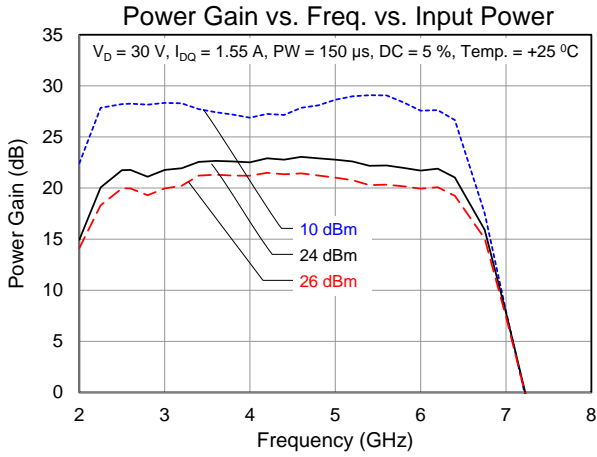



### Typical Performance: Linearity, CW

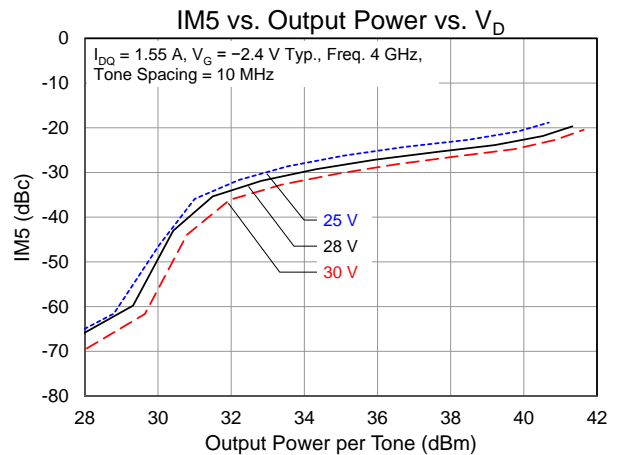
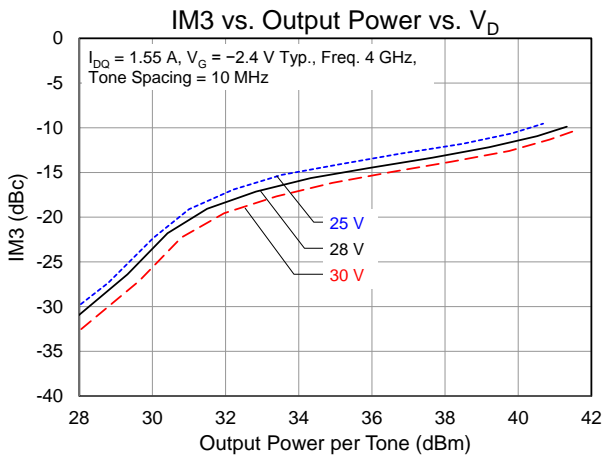
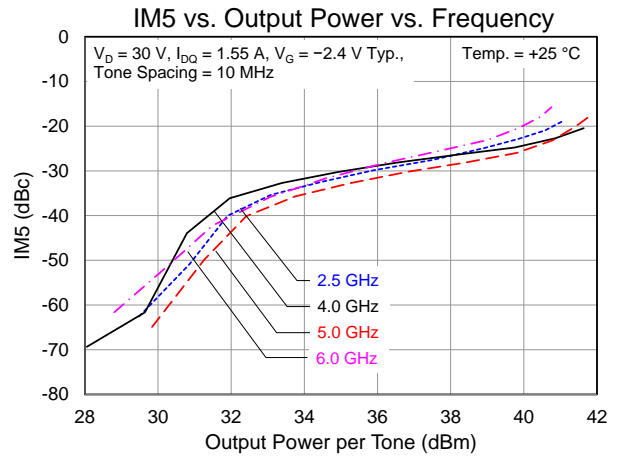
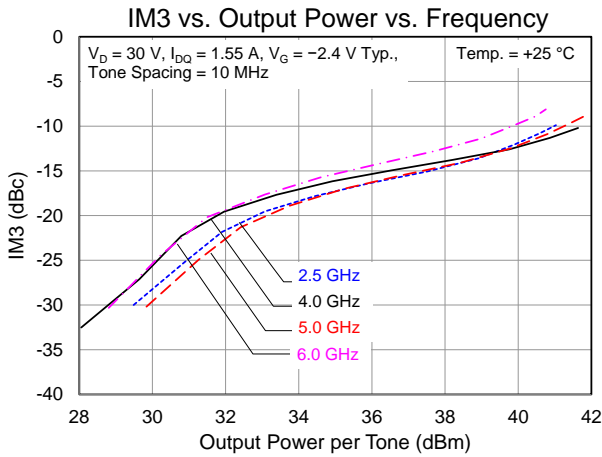
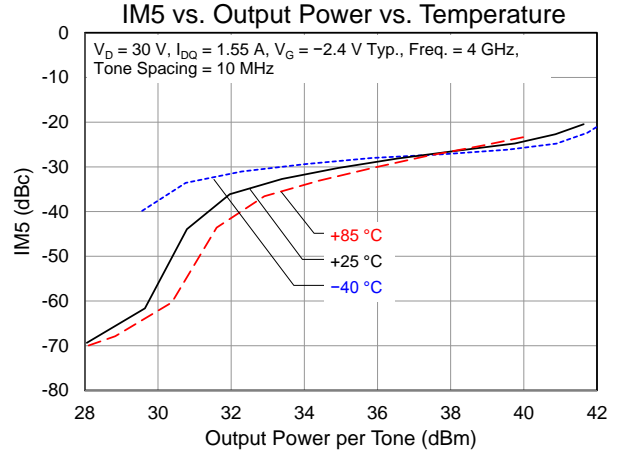
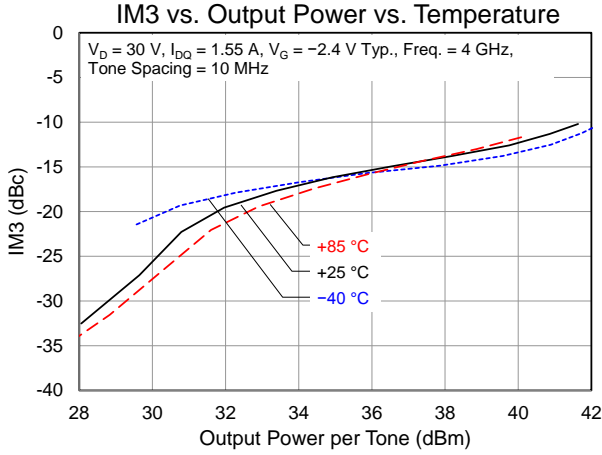

**Typical Performance (con't)**

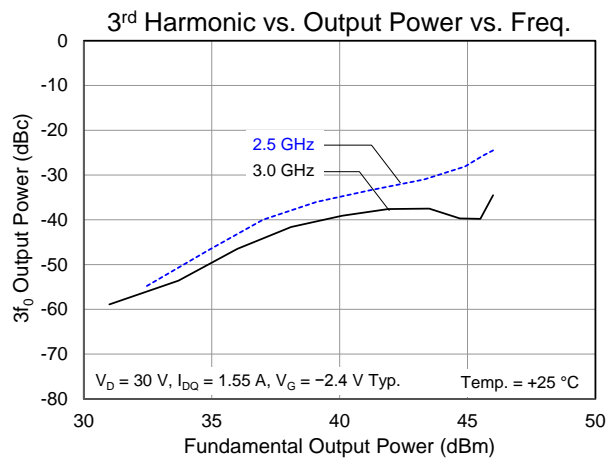
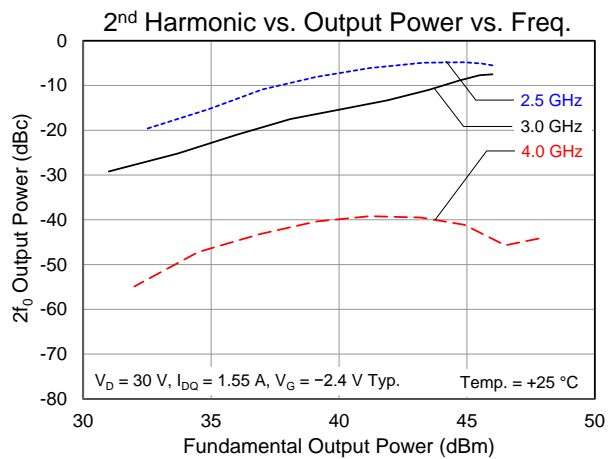

### Application Circuit

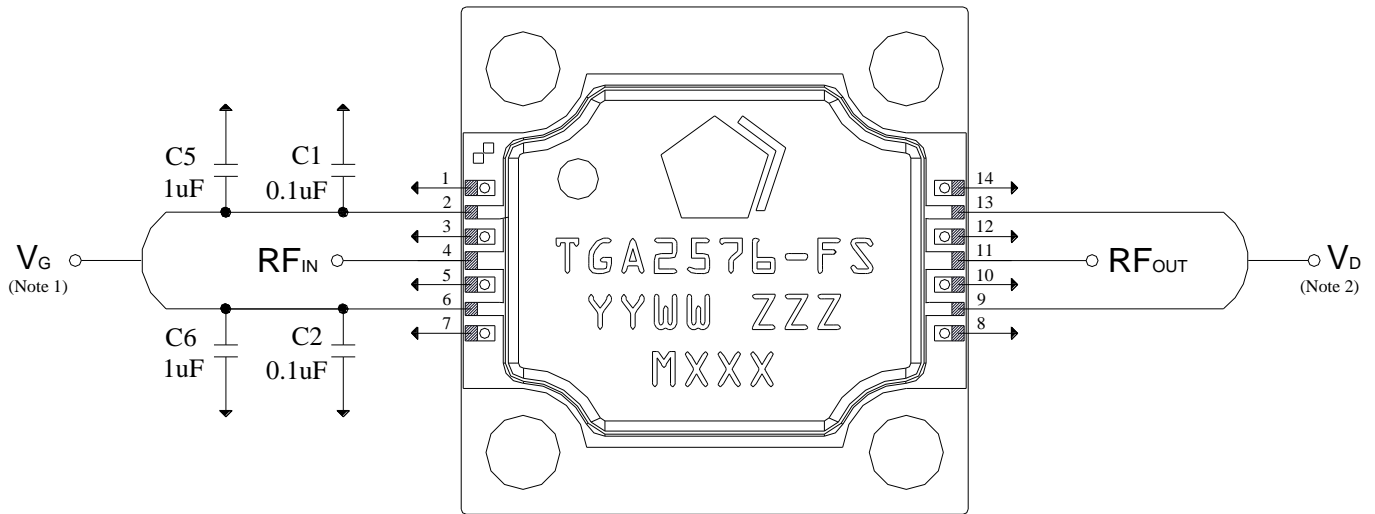

#### Notes:

1.  $V_G$  can be biased from either side (Pins 2 or 6)
2.  $V_D$  must be biased from both sides (Pins 9 and 13)

### Bias-up Procedure

1. Set power supply:  $I_D$  limit to 5 A,  $I_G$  limit to 10 mA
2. Apply -5.0 V to  $V_G$  (for pinch-off)
3. Increase  $V_D$  to +30V; Ensure  $I_{DQ} < 10$  mA
4. Adjust  $V_G$  more positive until  $I_{DQ, PEAK} = 1.55$  A ( $I_{DQ, AVG} = 77.5$  mA for 5% duty cycle);  $V_G \sim -2.4$  V typ
5. Apply RF signal

### Bias-down Procedure

1. Turn off RF signal
2. Reduce  $V_G$  to -5.0 V; Ensure  $I_{DQ} \sim 0$  mA
3. Reduce  $V_D$  to 0 V or turn off the pulse generator to disable the  $V_D$  modulator
4. Turn off  $V_G$  supply

**Pin Description**

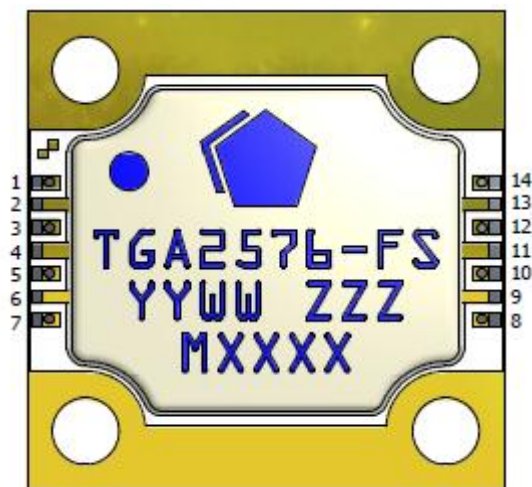

Pin	Symbol	Description
1, 3, 5, 7, 8, 10, 12, 14	Gnd	Ground; may be grounded or left open on PCB.
2, 6	$V_G$	Gate voltage <sup>(1)</sup>
4	$RF_{IN}$	Input; matched to 50 $\Omega$ ; DC shorted to ground
9, 13	$V_D$	Drain voltage <sup>(2)</sup> ; Pulsed operation (not recommend for CW)
11	$RF_{OUT}$	Output; matched to 50 $\Omega$ ; DC shorted to ground
	Package Base	RF and DC ground.

Notes:

1. Bias network is required; can be biased from either side (Pins 2 or 6); see Application Circuit on page 11
2. Bias network is required; must be biased from both sides (Pins 9 and 13); see Application Circuit on page 11

### Evaluation Board Layout

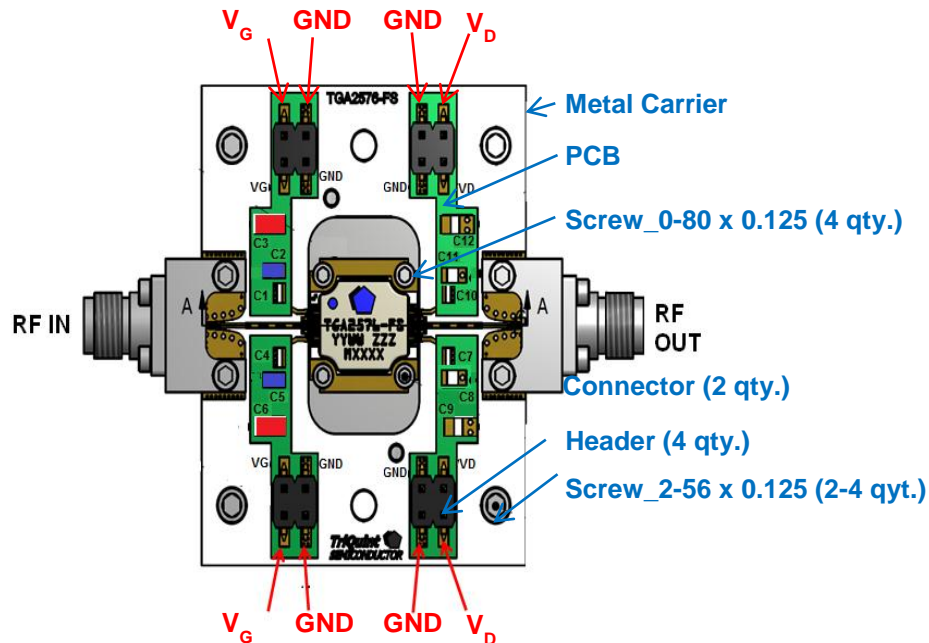

### Bill of Material

Reference Des.	Value	Description	Manuf.	Part Number
Metal Carrier, PCB		Download file at: <a href="http://www.TriQuint.com/Products/p/TGA2576-FS">www.TriQuint.com/Products/p/TGA2576-FS</a>	Various	
C2, C5	0.1 $\mu$ F	Cap, 0603, 50 V, 10%, X7R	Various	
C3, C6	1 $\mu$ F	Cap, 1206, 50 V, 10%, X7R	Various	

### Recommended Assembly Evaluation Board

1. Attach PCB to carrier using film epoxy (i.e Ablefilm 5028E)
2. Attach TGA2576-FS to carrier using thermal compound or 4 mils indium shim and screws (0-80 x 0.125)
3. Bond two wires (0.001" dia.) from RF<sub>IN</sub> (pin 4) to PCB; and three wires from RF<sub>OUT</sub> (pin 11) to PCB; ensure bond wires as short as possible
4. Bond one wire (0.001" dia.) from V<sub>G</sub> (pin 2 and/or pin 6) to PCB; and four wires from V<sub>D</sub> (pin 9 and pin 13) to PCB; ensure bond wires as short as possible
5. Attach 2x2 headers (i.e C-146130 Tyco Electronics) using solder (i.e Sn62Pb35/AG2)
6. Attach connector (i.e SMA 1092-01A-5 Southwest Microwave) to clamp down PCB and carrier; launch connector pins needs to be aligned to PCB trace and to make contact to metal surface

Notes: to improve the thermal and thus RF performance, we recommend the following:

1. If using temperature-controlled cold-plate: mount Evaluation Board to cold-plate using screws (2-26 x 0.125) at the 4 corner mounting holes
2. If without cold-plate: attached a heat sink and fan to Evaluation Board using thermal compound or 4 mils indium shim and screws (2-26 x 0.125)
3. Slide a thermocouple into the hole on the side of carrier for monitoring package T<sub>BASE</sub> (if desired); the temperature difference between thermocouple and T<sub>BASE</sub> is appx. 10 °C typical (for  $\leq$  20% duty cycle operation)

### Mechanical Information

Marking:  
 Part number: TGA2576-FS  
 Year/Week/Serial number: YYWW ZZZ  
 Batch ID: MXXX

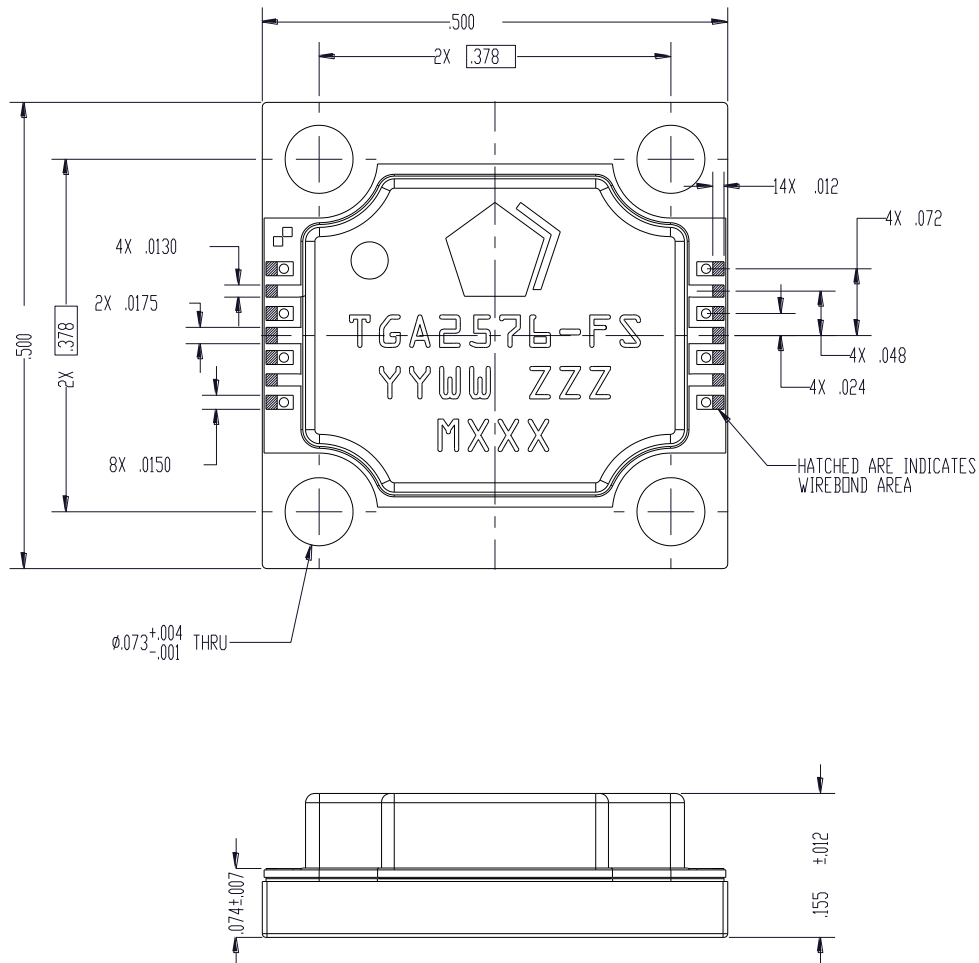

**Notes:**

1. Unless specified otherwise, dimensions are in inches.
2. Unless specified otherwise, tolerances are  $\pm 0.005$
3. Materials:
  - Package base material: Copper (Cu)
  - Package base finish: Gold (Au) 50 uin min over Nickel (Ni) 200 uin min
  - Package lid: LCP (Liquid Crystal Polymer)
  - Bond Pads (hatched): Gold plate per ASTM B 488, Type III, Grade A, Class 1, 50 uin min

**Product Compliance Information****ESD Sensitivity Ratings****Caution! ESD-Sensitive Device**

ESD Rating: Class 1B  
Value:  $\geq 500V$  and  $< 1000V$   
Test: Human Body Model (HBM)  
Standard: JEDEC Standard JESD22-A114

**MSL Rating**

Level 5a at +260 °C convection reflow  
The part is rated Moisture Sensitivity Level 5a at 260°C per  
JEDEC standard IPC/JEDEC J-STD-020.

**ECCN**

US Department of Commerce: 3A001.b.2.a

**Solderability**

This product also has the following attributes:

- Lead Free
- Halogen Free (Chlorine, Bromine)
- Antimony Free
- TBBP-A (C<sub>15</sub>H<sub>12</sub>Br<sub>4</sub>O<sub>2</sub>) Free
- PFOS Free
- SVHC Free

**Contact Information**

For the latest specifications, additional product information, worldwide sales and distribution locations, and information about TriQuint:

**Web:** [www.triquint.com](http://www.triquint.com)**Tel:** +1.972.994.8465**Email:** [info-sales@triquint.com](mailto:info-sales@triquint.com)**Fax:** +1.972.994.8504For technical questions and application information: **Email:** [info-products@triquint.com](mailto:info-products@triquint.com)**Important Notice**

The information contained herein is believed to be reliable. TriQuint makes no warranties regarding the information contained herein. TriQuint assumes no responsibility or liability whatsoever for any of the information contained herein. TriQuint assumes no responsibility or liability whatsoever for the use of the information contained herein. The information contained herein is provided "AS IS, WHERE IS" and with all faults, and the entire risk associated with such information is entirely with the user. All information contained herein is subject to change without notice. Customers should obtain and verify the latest relevant information before placing orders for TriQuint products. The information contained herein or any use of such information does not grant, explicitly or implicitly, to any party any patent rights, licenses, or any other intellectual property rights, whether with regard to such information itself or anything described by such information.

TriQuint products are not warranted or authorized for use as critical components in medical, life-saving, or life-sustaining applications, or other applications where a failure would reasonably be expected to cause severe personal injury or death.